

# Product data sheet

Specifications

SQUARE D

Green Premium™



Circuit breaker, PowerPacT Q, 225A, 3 pole, 240VAC, 65kA, lugs, thermal magnetic, 80%

QGL32225

## Main

Range	PowerPact
Product name	PowerPact Q
Product or component type	Circuit breaker
Device application	Distribution

## Complementary

[In] rated current	225 A
Number of Poles	3P
Control type	Operating handle
Breaking capacity code	G
Breaking capacity	65 kA 120/208 V AC 50/60 Hz UL 65 kA 240 V AC 50/60 Hz UL
[Ue] rated operational voltage	240 V AC 50/60 Hz UL
Network frequency	50/60 Hz
[Uimp] rated impulse withstand voltage	8 kV UL
Trip unit technology	Thermal-magnetic
Magnetic tripping current	2400 A
Magnetic hold current	1200 A
Continuous current rating	80 %
Utilisation category	Category A
Mechanical durability	1000 cycles loaded 5000 cycles no load
Local signalling	1 trip indicator (green)
Mounting mode	Unit mount (lug)
Mounting support	Lug
Electrical connection	Lugs load Lugs line
Tightening torque	247.82 lbf.in (28 N.m) 0.04...0.23 in <sup>2</sup> (25...150 mm <sup>2</sup> ) AWG 4...300 kcmil)
Power wire stripping length	0.87 in (22 mm)
Height	6.47 in (164.34 mm)

Disclaimer: This documentation is not intended as a substitute for and is not to be used for determining suitability or reliability of these products for specific user applications

<b>Width</b>	4.5 in (114.30 mm)
<b>Depth</b>	3.93 in (99.82 mm)
<b>Circuit breaker application</b>	HACR rated

## Environment

<b>Standards</b>	UL CSA NEMA NOM-003-SCFI-2000
<b>Product certifications</b>	UL CSA NOM
<b>Ambient air temperature for operation</b>	104...158 °F (40...70 °C)

## Packing Units

<b>Unit Type of Package 1</b>	PCE
<b>Number of Units in Package 1</b>	1
<b>Package 1 Height</b>	6.18 in (15.7 cm)
<b>Package 1 Width</b>	6.30 in (16.0 cm)
<b>Package 1 Length</b>	9.80 in (24.9 cm)
<b>Package 1 Weight</b>	4.76 lb(US) (2.16 kg)

## Offer Sustainability

<b>Sustainable offer status</b>	Green Premium product
<b>REACH Regulation</b>	<a href="#">REACH Declaration</a>
<b>REACH free of SVHC</b>	Yes
<b>EU RoHS Directive</b>	Compliant <a href="#">EU RoHS Declaration</a>
<b>Mercury free</b>	Yes
<b>China RoHS Regulation</b>	<a href="#">China RoHS declaration</a> Product out of China RoHS scope. Substance declaration for your information
<b>RoHS exemption information</b>	<a href="#">Yes</a>
<b>Environmental Disclosure</b>	<a href="#">Product Environmental Profile</a>
<b>PVC free</b>	Yes
<b>Halogen content performance</b>	Halogen free product

## Contractual warranty

<b>Warranty</b>	18 months
-----------------	-----------

Dimensions

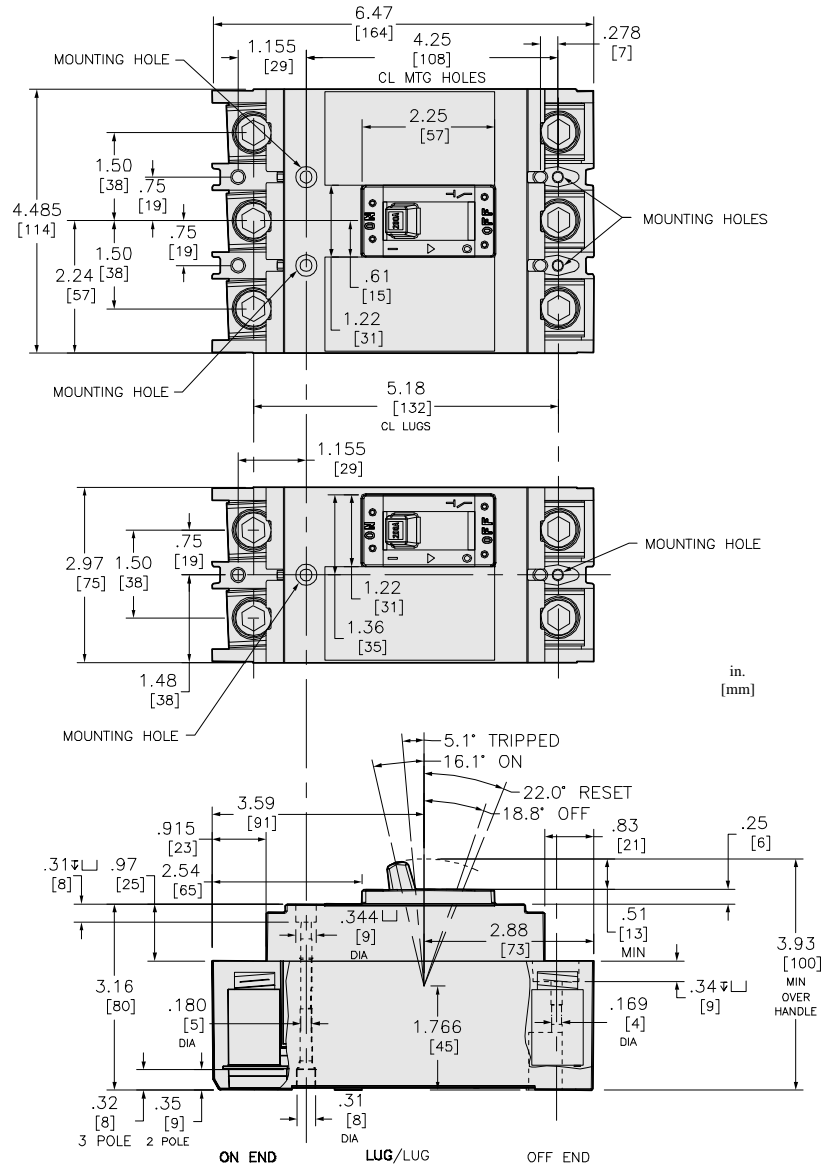

ALL DIMENSIONS ARE APPROXIMATE.  
 ALSO SEE TECHNICAL DRAWINGS AND DOCUMENTATION.

Recommended replacement(s)