

Product data sheet

Specifications

SQUARE D

Green Premium™



Circuit breaker, PowerPacT Q,
200A, 3 pole, 240VAC, 25kA, lugs,
thermal magnetic, 80%

QDL32200

Main

Range	PowerPact
Product name	PowerPact Q
Product or component type	Circuit breaker
Device application	Distribution

Complementary

[In] rated current	200 A
Number of Poles	3P
Control type	Operating handle
Breaking capacity code	D
Breaking capacity	25 kA 120/208 V AC 50/60 Hz UL 25 kA 240 V AC 50/60 Hz UL
[Ue] rated operational voltage	240 V AC 50/60 Hz UL
Network frequency	50/60 Hz
[Uimp] rated impulse withstand voltage	8 kV UL
Trip unit technology	Thermal-magnetic
Magnetic tripping current	2400 A
Magnetic hold current	1200 A
Continuous current rating	80 %
Utilisation category	Category A
Mechanical durability	1000 cycles loaded 5000 cycles no load
Local signalling	1 trip indicator (green)
Mounting mode	Unit mount (lug)
Mounting support	Lug
Electrical connection	Lugs load Lugs line
Tightening torque	247.82 lbf.in (28 N.m) 0.04...0.23 in ² (25...150 mm ²) AWG 4...300 kcmil)
Power wire stripping length	0.87 in (22 mm)
Height	6.47 in (164.34 mm)

Disclaimer: This documentation is not intended as a substitute for and is not to be used for determining suitability or reliability of these products for specific user applications

Width	4.5 in (114.30 mm)
Depth	3.93 in (99.82 mm)
Circuit breaker application	HACR rated

Environment

Standards	UL CSA NEMA NOM-003-SCFI-2000
Product certifications	UL CSA NOM
Ambient air temperature for operation	104...158 °F (40...70 °C)

Packing Units

Unit Type of Package 1	PCE
Number of Units in Package 1	1
Package 1 Height	6.18 in (15.7 cm)
Package 1 Width	6.18 in (15.7 cm)
Package 1 Length	9.80 in (24.9 cm)
Package 1 Weight	4.76 lb(US) (2.16 kg)

Offer Sustainability

Sustainable offer status	Green Premium product
REACH Regulation	REACH Declaration
REACH free of SVHC	Yes
EU RoHS Directive	Compliant EU RoHS Declaration
Mercury free	Yes
China RoHS Regulation	China RoHS declaration Product out of China RoHS scope. Substance declaration for your information
RoHS exemption information	Yes
Environmental Disclosure	Product Environmental Profile
PVC free	Yes
Halogen content performance	Halogen free product

Contractual warranty

Warranty	18 months
-----------------	-----------

Dimensions

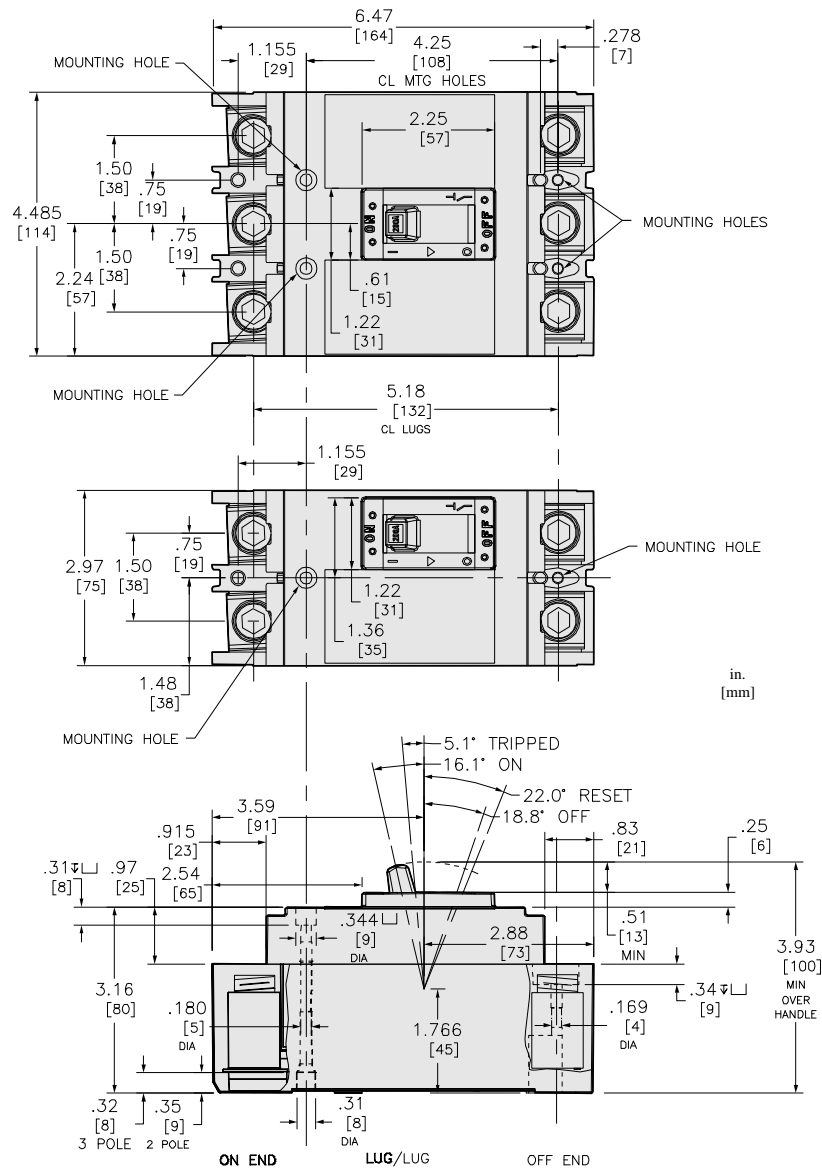

ALL DIMENSIONS ARE APPROXIMATE.
 ALSO SEE TECHNICAL DRAWINGS AND DOCUMENTATION.

Recommended replacement(s)