

Product data sheet

Specifications

SQUARE D

Green Premium™



Circuit breaker, LA, 225A, 3 pole, 600VAC, 22kA, 250VDC, 10kA, lugs

LAL36225

Main

Product or component type	Circuit breaker
Trip Unit Technology	Thermal-magnetic

Complementary

[In] rated current	225 A
Number of Poles	3P
Mounting Mode	Unit mount
Magnetic Hold Current	1125 A
Magnetic Tripping Current	2250 A
Electrical connection	Lugs load Lugs line
Terminal identifier	AL400LA
Tightening torque	115.06 lbf.in (13 N.m) 0.07...0.47 in ² (42...304 mm ²) AWG 1...600 kcmil 115.06 lbf.in (13 N.m) 0.07...0.20 in ² (42...127 mm ²) AWG 1...250 kcmil
Height	11 in (279.40 mm)
Width	6 in (152.40 mm)
Depth	5.84 in (148.34 mm)
Circuit breaker application	HACR rated

Environment

Certifications	IEC CSA UL listed
----------------	-------------------------

Packing Units

Unit Type of Package 1	PCE
Number of Units in Package 1	1
Package 1 Height	9.21 in (23.4 cm)
Package 1 Width	11.50 in (29.2 cm)
Package 1 Length	17.28 in (43.9 cm)
Package 1 Weight	16.38 lb(US) (7.43 kg)

Offer Sustainability

Sustainable offer status	Green Premium product
REACH Regulation	REACH Declaration
EU RoHS Directive	Compliant EU RoHS Declaration
Mercury free	Yes
RoHS exemption information	Yes
China RoHS Regulation	China RoHS declaration Product out of China RoHS scope. Substance declaration for your information
Environmental Disclosure	Product Environmental Profile
PVC free	Yes
Halogen content performance	Halogen free plastic parts product

Dimensions

Electrical Clearance / Wire Bending Space

Wire bending space is based upon the maximum wire size of the terminal, and NEC article 430-10. Wire bending space for the bottom is the same as the top wire bending space.

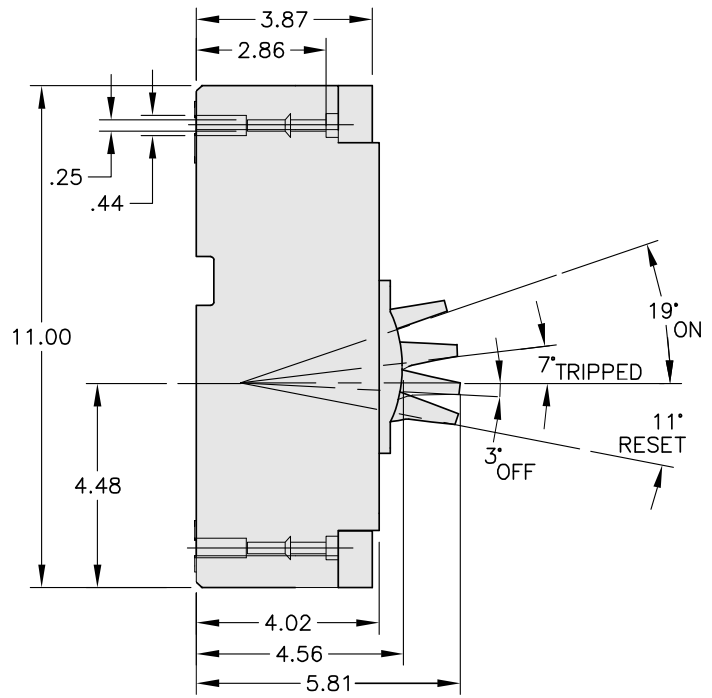
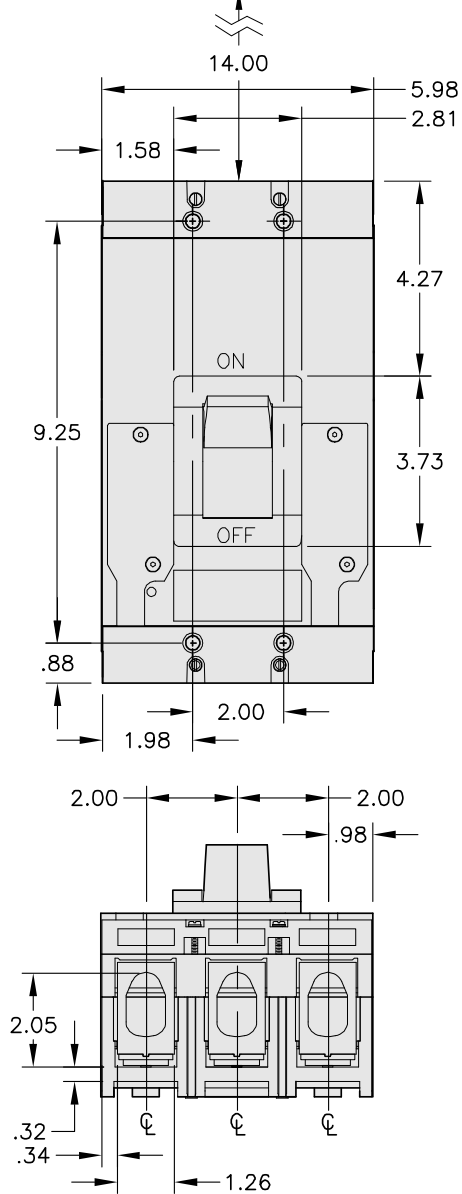

ALL DIMENSIONS ARE APPROXIMATE.
 ALSO SEE CAD, TECHNICAL DRAWINGS, AND TECHNICAL DOCUMENTATION

Recommended replacement(s)