

Product data sheet

Specifications

SQUARE D

Green Premium™



Circuit breaker, PowerPacT J, 175A, 3 pole, 600VAC, 50kA, lugs, thermal magnetic, 80%

JLL36175

Main

Product or component type Circuit breaker

Complementary

[In] rated current 175 A

Number of Poles 3P

Control type Toggle

Breaking capacity code L

Breaking capacity 125 kA 240 V AC 50/60 Hz UL 489
100 kA 480 V AC 50/60 Hz UL 489
50 kA 600 V AC 50/60 Hz UL 489
20 kA 250 V DC UL 489
50 kA 500 V DC UL 489

[Ue] rated operational voltage 600 V AC 50/60 Hz IEC 60947-3

Network frequency 50/60 Hz

[Ics] rated service breaking capacity 125 kA 220/240 V AC 50/60 Hz IEC 60947-2
100 kA 380/440/415 V AC 50/60 Hz IEC 60947-2
50 kA 500/525 V AC 50/60 Hz IEC 60947-2
20 kA 250 V DC IEC 60947-2
20 kA 500 V DC IEC 60947-2

[Uimp] rated impulse withstand voltage 8 kV IEC 60947-2

Trip unit technology Thermal-magnetic

Magnetic tripping current 1750 A

Magnetic hold current 875 A

Continuous current rating 80 %

[Ui] rated insulation voltage 750 V IEC 60947-2

Protection type Overload protection
Short-circuit protection

Suitability for isolation Yes IEC 60947-2

Utilisation category Category A

AWG gauge AWG 4...AWG 4/0 aluminum/copper terminal

Local signalling Switched off (OFF) 1 trip indicator green)

Mounting mode Unit mount lug)

Mounting support Lug

Electrical connection Lugs line

	Lugs load
Terminal identifier	AL175JD
Long time pick-up adjustment range	0.25...1 x In
Tightening torque	221.27 lbf.in (25 N.m) 0.04...0.15 in ² (25...95 mm ²) AWG 4...AWG 4/0
Number of slots	2 auxiliary switch OF plug-in) 1 alarm switch SD plug-in) 1 overcurrent trip switch SDE plug-in) 1 voltage release MN or MX plug-in)
Power wire stripping length	0.98 in (25 mm)
Height	7.52 in (191 mm)
Width	4.09 in (104 mm)
Depth	3.39 in (86 mm)
Net weight	5.29 lb(US) (2.4 kg)
Communication interface	Modbus
Circuit breaker application	HACR rated

Environment

Quality labels	CE
Standards	UL CSA NEMA NOM-003-SCFI-2000 IEC 60947-2
Product certifications	UL CSA NOM
IP degree of protection	Front cover IP40
Pollution degree	3
Ambient air temperature for operation	28...158 °F (-2...70 °C)
Ambient air temperature for storage	-58...185 °F (-50...85 °C)
Operating altitude	< 2000 m without derating 5000 m with derating

Packing Units

Unit Type of Package 1	PCE
Number of Units in Package 1	1
Package 1 Height	5.13 in (13.018 cm)
Package 1 Width	7.25 in (18.415 cm)
Package 1 Length	8.44 in (21.433 cm)
Package 1 Weight	4.91 lb(US) (2.225 kg)

Offer Sustainability

Sustainable offer status	Green Premium product
REACH Regulation	REACH Declaration
EU RoHS Directive	Compliant EU RoHS Declaration
Mercury free	Yes
China RoHS Regulation	China RoHS declaration Product out of China RoHS scope. Substance declaration for your information

RoHS exemption information	Yes
Environmental Disclosure	Product Environmental Profile
Circularity Profile	End of Life Information

PVC free Yes

Contractual warranty

Warranty 18 months

Approximate Dimensions

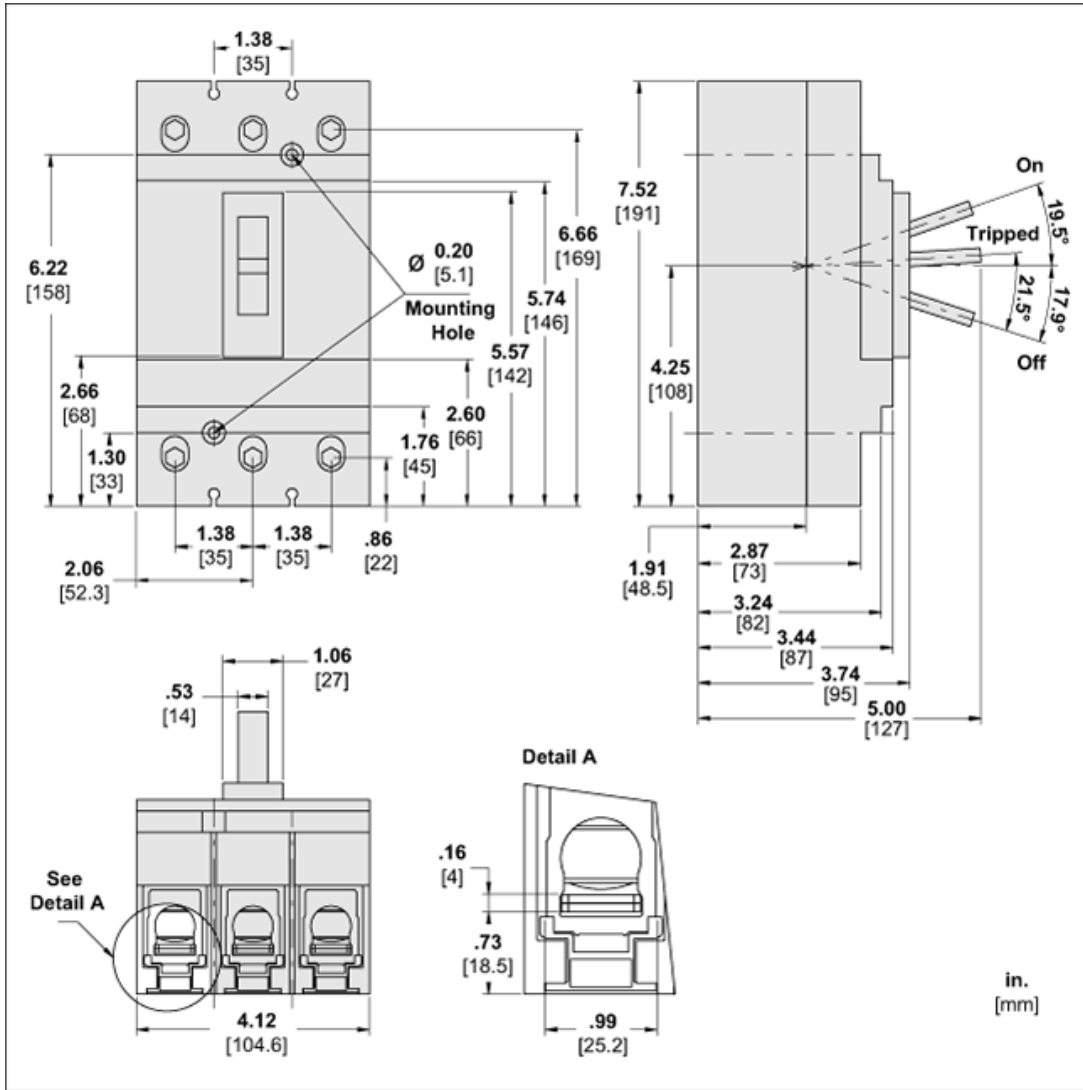

Dimensions

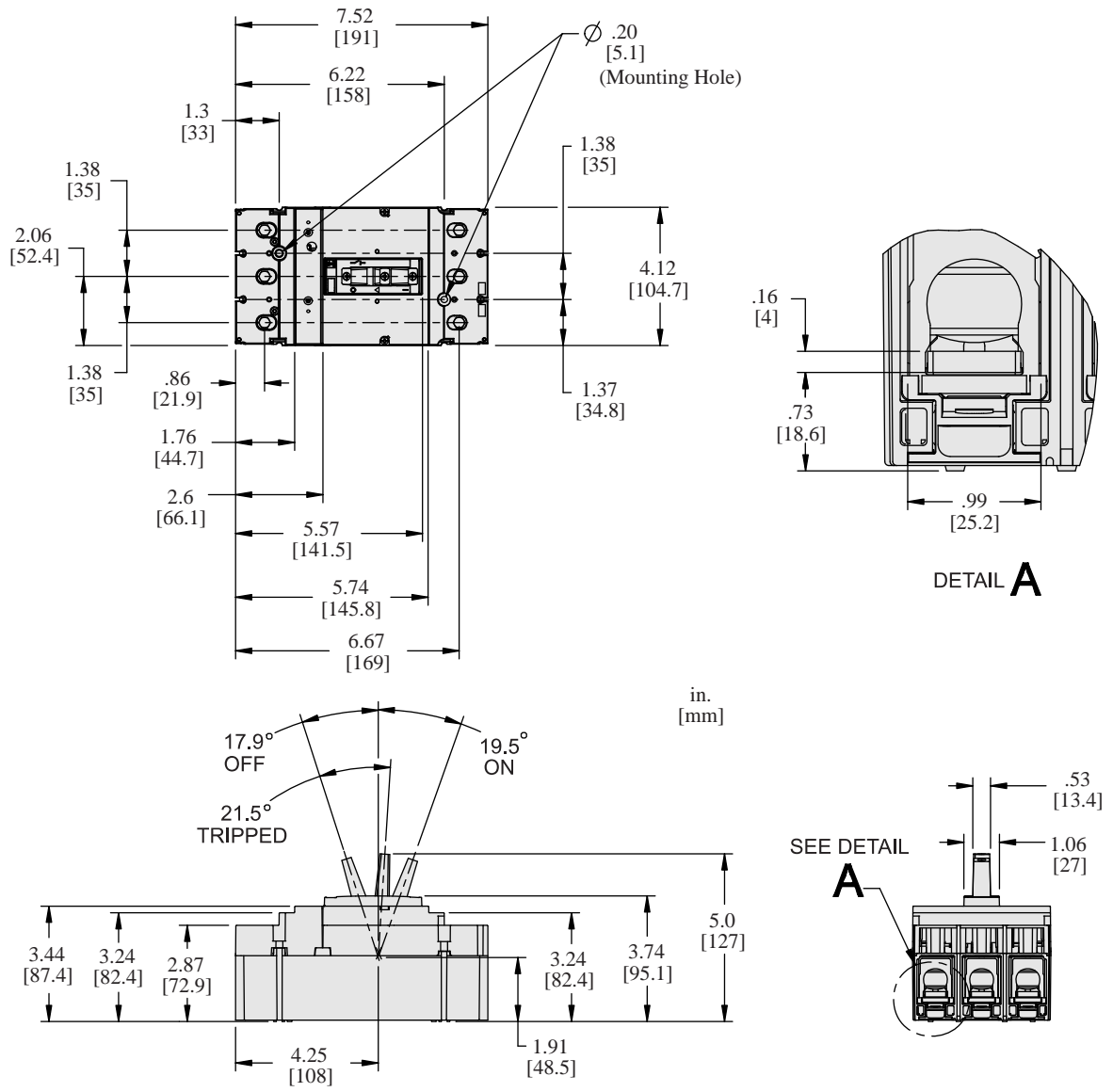

ALL DIMENSIONS ARE APPROXIMATE.
 ALSO REFER TO TECHNICAL DRAWINGS AND DOCUMENTATION.

Recommended replacement(s)