

Product data sheet

Specifications

SQUARE D

Green Premium™



Circuit breaker, PowerPacT J, 225A, 3 pole, 600VAC, 18kA, I-Line, thermal magnetic, 80%, ABC

JGA36225

Main

Range	PowerPact
Product name	PowerPact J
Product or component type	Circuit breaker
Device application	Distribution

Complementary

[In] rated current	225 A
Number of Poles	3P
Control type	Toggle
Breaking capacity code	G
Breaking capacity	65 kA 240 V AC 50/60 Hz UL 489 35 kA 480 V AC 50/60 Hz UL 489 18 kA 600 V AC 50/60 Hz UL 489 20 kA 250 V DC UL 489 20 kA 500 V DC UL 489
[Ue] rated operational voltage	600 V AC 50/60 Hz IEC 60947-3
Network frequency	50/60 Hz
[Ics] rated service breaking capacity	65 kA 220/240 V AC 50/60 Hz IEC 60947-2 35 kA 380/440/415 V AC 50/60 Hz IEC 60947-2 18 kA 500/525 V AC 50/60 Hz IEC 60947-2 20 kA 250 V DC IEC 60947-2 20 kA 500 V DC IEC 60947-2
[Uimp] rated impulse withstand voltage	8 kV IEC 60947-2
Trip unit technology	Thermal-magnetic
Magnetic tripping current	2250 A
Magnetic hold current	1125 A
Continuous current rating	80 %
[Ui] rated insulation voltage	750 V IEC 60947-2
Protection type	Overload protection Short-circuit protection
Suitability for isolation	Yes IEC 60947-2
Utilisation category	Category A
AWG gauge	AWG 3/0...350 kcmil aluminum/copper terminals

Local signalling	Switched off (OFF) 1 trip indicator green)
Mounting mode	I-Line bracket)
Mounting support	Bracket
Electrical connection	I-Line connection line Lugs load
Terminal identifier	AL250JD
Long time pick-up adjustment range	0.25...1 x In
Mounting height	4.5 in (114.30 mm)
Tightening torque	221.27 lbf.in (25 N.m) 0.15...0.29 in ² (95...185 mm ²) AWG 3/0...350 kcmil)
Number of slots	2 auxiliary switch OF plug-in) 1 alarm switch SD plug-in) 1 overcurrent trip switch SDE plug-in) 1 voltage release MN or MX plug-in)
Power wire stripping length	0.98 in (25 mm)
Height	7.52 in (191 mm)
Width	4.09 in (104 mm)
Depth	3.39 in (86 mm)
Net weight	5.29 lb(US) (2.4 kg)
Phase connection	ABC
Communication interface	Modbus Ethernet
Circuit breaker application	HACR rated

Environment

Quality labels	CE
Standards	UL CSA NEMA NOM-003-SCFI-2000 IEC 60947-2
Product certifications	UL CSA NOM
IP degree of protection	Front cover IP40
Pollution degree	3 IEC 60947-1
Ambient air temperature for operation	28...158 °F (-2...70 °C)
Ambient air temperature for storage	-58...185 °F (-50...85 °C)
Operating altitude	< 2000 m without derating 5000 m with derating

Packing Units

Unit Type of Package 1	PCE
Number of Units in Package 1	1
Package 1 Height	5.91 in (15.0 cm)
Package 1 Width	8.39 in (21.3 cm)
Package 1 Length	14.88 in (37.8 cm)
Package 1 Weight	6.66 lb(US) (3.02 kg)

Offer Sustainability

Sustainable offer status	Green Premium product
REACH Regulation	REACH Declaration
EU RoHS Directive	Compliant EU RoHS Declaration
Mercury free	Yes
China RoHS Regulation	China RoHS declaration Product out of China RoHS scope. Substance declaration for your information
RoHS exemption information	Yes
Environmental Disclosure	Product Environmental Profile
Circularity Profile	End of Life Information
PVC free	Yes

Contractual warranty

Warranty	18 months
----------	-----------

Dimensions

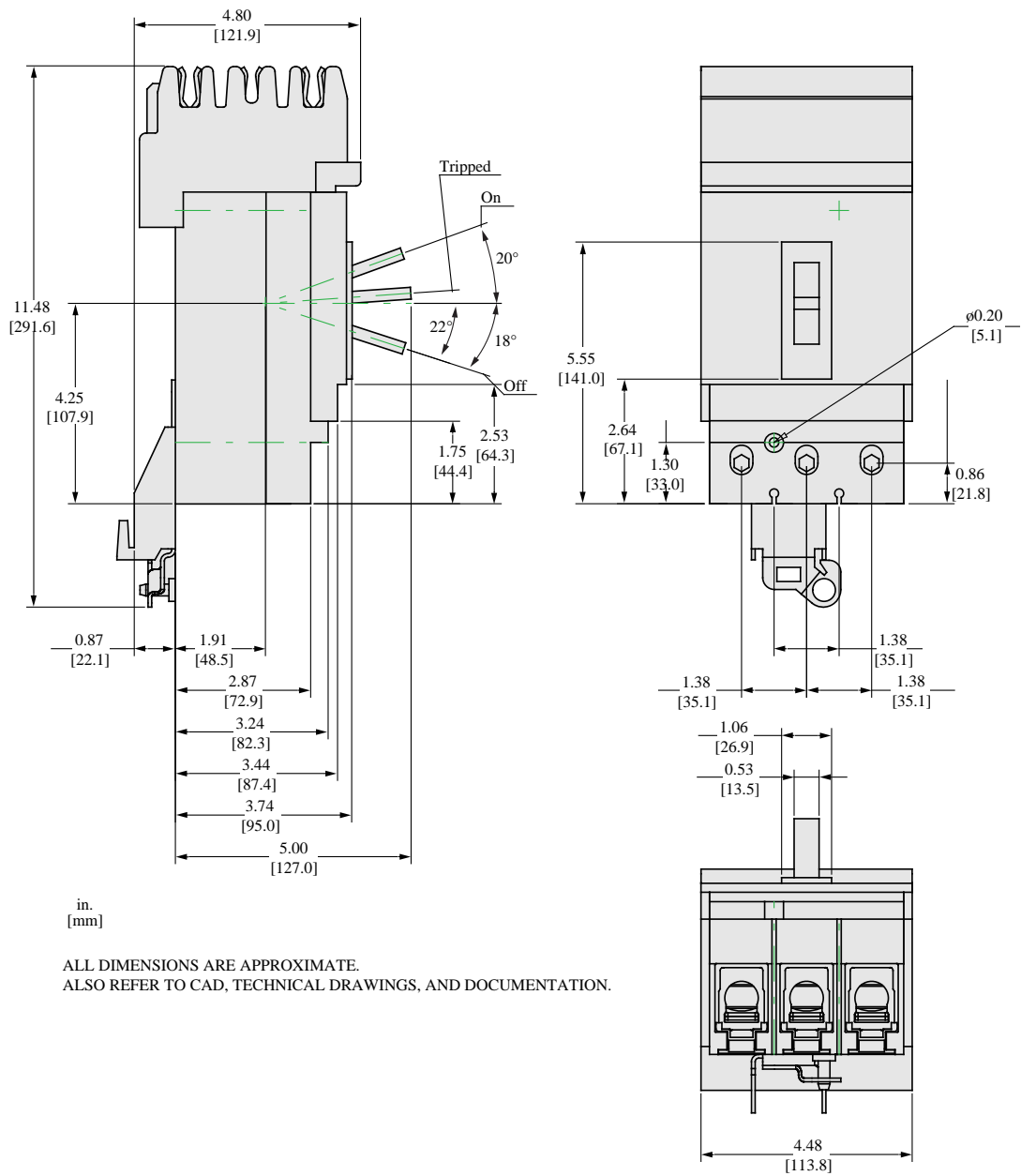

in.
[mm]

ALL DIMENSIONS ARE APPROXIMATE.
 ALSO REFER TO CAD, TECHNICAL DRAWINGS, AND DOCUMENTATION.

Recommended replacement(s)