

# Product data sheet

Specifications

SQUARE D

Green Premium™



Circuit breaker, PowerPacT H, 40A, 3 pole, 600VAC, 50kA, I-Line, thermal magnetic, 80%, ABC

HLA36040

## Main

Range	PowerPact
Product name	PowerPact H
Product or component type	Circuit breaker
Device application	Distribution

## Complementary

[In] rated current	40 A
Number of Poles	3P
Protected poles description	3t
Control type	Toggle
Breaking capacity code	L
Breaking capacity	125 kA 240 V AC 50/60 Hz UL 489 100 kA 480 V AC 50/60 Hz UL 489 50 kA 600 V AC 50/60 Hz UL 489 20 kA 250 V DC UL 489 50 kA 500 V DC UL 489
[Ue] rated operational voltage	690 V AC 50/60 Hz IEC 60947-3
Network frequency	50/60 Hz
[Ics] rated service breaking capacity	125 kA 220/240 V AC 50/60 Hz IEC 60947-2 100 kA 380/440/415 V AC 50/60 Hz IEC 60947-2 50 kA 500/525 V AC 50/60 Hz IEC 60947-2 20 kA 250 V DC IEC 60947-2 20 kA 500 V DC IEC 60947-2
[Uimp] rated impulse withstand voltage	8 kV IEC 60947-2
Trip unit technology	Thermal-magnetic
Magnetic tripping current	850 A
Magnetic hold current	400 A
Continuous current rating	80 %
[Ui] rated insulation voltage	750 V IEC 60947-2
Suitability for isolation	Yes IEC 60947-2
Utilisation category	Category A
AWG gauge	AWG 14...AWG 3/0 aluminum/copper terminal
Local signalling	Switched off (OFF) 1 trip indicator green)

<b>Mounting mode</b>	I-Line bracket)
<b>Mounting support</b>	Bracket
<b>Electrical connection</b>	I-Line connection line Lugs load
<b>Terminal identifier</b>	AL150HD
<b>Mounting height</b>	4.5 in (114.30 mm)
<b>Tightening torque</b>	44.25 lbf.in (5 N.m) 0.00...0.01 in <sup>2</sup> (2.5...6 mm <sup>2</sup> ) AWG 14...AWG 10) 123.91 lbf.in (14 N.m) 0.02...0.15 in <sup>2</sup> (10...95 mm <sup>2</sup> ) AWG 8...AWG 3/0)
<b>Number of slots</b>	2 auxiliary switch OF plug-in) 1 alarm switch SD plug-in) 1 overcurrent trip switch SDE plug-in) 1 voltage release MN or MX plug-in)
<b>Power wire stripping length</b>	0.63 in (16 mm)
<b>Color</b>	Black
<b>Height</b>	6.42 in (163 mm)
<b>Width</b>	4.09 in (104 mm)
<b>Depth</b>	3.39 in (86 mm)
<b>Net weight</b>	4.85 lb(US) (2.2 kg)
<b>Quantity per set</b>	1
<b>Phase connection</b>	ABC
<b>Communication interface</b>	Modbus Ethernet
<b>Circuit breaker application</b>	HACR rated

## Environment

<b>Quality labels</b>	CE
<b>Standards</b>	UL CSA NEMA NOM-003-SCFI-2000 IEC 60947-2
<b>Product certifications</b>	UL CSA NOM
<b>IP degree of protection</b>	Front cover IP40 IEC 60529
<b>Pollution degree</b>	3 IEC 60947-1
<b>Ambient air temperature for operation</b>	28...158 °F (-2...70 °C)
<b>Ambient air temperature for storage</b>	-58...185 °F (-50...85 °C)
<b>Operating altitude</b>	< 2000 m without derating 5000 m with derating

## Packing Units

<b>Unit Type of Package 1</b>	PCE
<b>Number of Units in Package 1</b>	1
<b>Package 1 Height</b>	5.59 in (14.2 cm)
<b>Package 1 Width</b>	8.39 in (21.3 cm)
<b>Package 1 Length</b>	14.88 in (37.8 cm)
<b>Package 1 Weight</b>	5.45 lb(US) (2.47 kg)

## Offer Sustainability

Sustainable offer status	Green Premium product
REACH Regulation	<a href="#">REACH Declaration</a>
EU RoHS Directive	Compliant <a href="#">EU RoHS Declaration</a>
Mercury free	Yes
China RoHS Regulation	<a href="#">China RoHS declaration</a> Product out of China RoHS scope. Substance declaration for your information
RoHS exemption information	Yes
Environmental Disclosure	<a href="#">Product Environmental Profile</a>
Circularity Profile	<a href="#">End of Life Information</a>
PVC free	Yes

## Contractual warranty

Warranty	18 months
----------	-----------

**Dimensions**

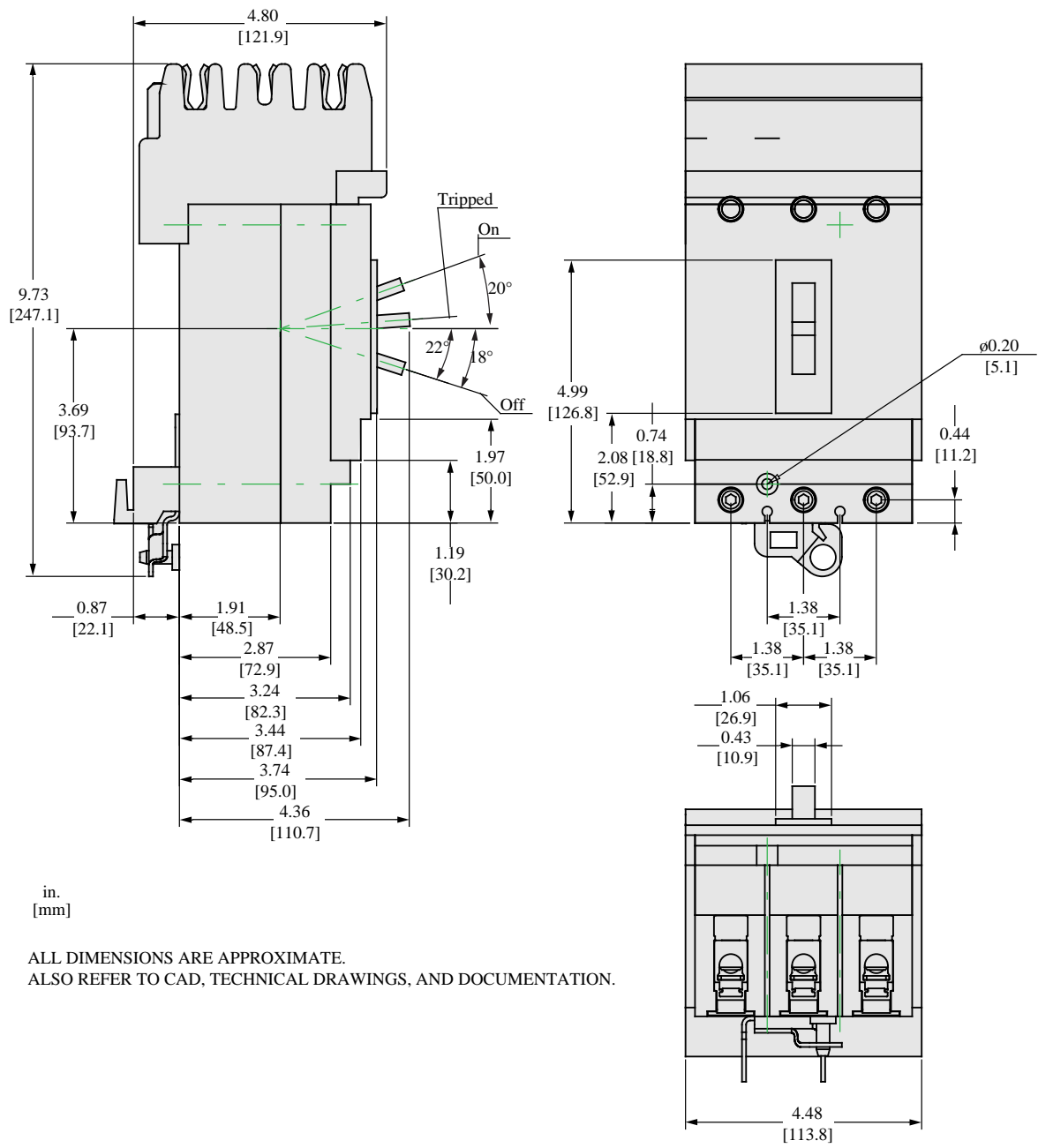

in.  
[mm]

ALL DIMENSIONS ARE APPROXIMATE.  
 ALSO REFER TO CAD, TECHNICAL DRAWINGS, AND DOCUMENTATION.

**Recommended replacement(s)**