

Product data sheet

Specifications

SQUARE D

Green Premium™



Circuit breaker, PowerPact H, 45A, 3 pole, 600VAC, 14kA, I-Line, thermal magnetic, 80%, ABC

HDA36045

Main

Range	PowerPact
Product name	PowerPact H
Product or component type	Circuit breaker
Device application	Distribution

Complementary

[In] rated current	45 A
Number of Poles	3P
Protected poles description	3t
Control type	Toggle
Breaking capacity code	D
Breaking capacity	25 kA 240 V AC 50/60 Hz UL 489 18 kA 480 V AC 50/60 Hz 14 kA 600 V AC 50/60 Hz 20 kA 250 V DC
[Ue] rated operational voltage	690 V AC 50/60 Hz IEC 60947-3
Network frequency	50/60 Hz
[Ics] rated service breaking capacity	25 kA 220/240 V AC 50/60 Hz IEC 60947-2 18 kA 380/440/415 V AC 50/60 Hz IEC 60947-2 14 kA 500/525 V AC 50/60 Hz IEC 60947-2 20 kA 250 V DC IEC 60947-2 20 kA 500 V DC IEC 60947-2
[Uimp] rated impulse withstand voltage	8 kV IEC 60947-2
Trip unit technology	Thermal-magnetic
Magnetic tripping current	850 A
Magnetic hold current	400 A
Continuous current rating	80 %
[Ui] rated insulation voltage	750 V IEC 60947-2
Suitability for isolation	Yes IEC 60947-2
Utilisation category	Category A
AWG gauge	AWG 14...AWG 3/0 aluminum/copper terminal
Local signalling	Switched off (OFF) 1 trip indicator green)

Mounting mode	I-Line bracket)
Mounting support	Bracket
Electrical connection	I-Line connection line Lugs load
Terminal identifier	AL150HD
Mounting height	4.5 in (114.30 mm)
Tightening torque	44.25 lbf.in (5 N.m) 0.00...0.01 in ² (2.5...6 mm ²) AWG 14...AWG 10) 123.91 lbf.in (14 N.m) 0.02...0.15 in ² (10...95 mm ²) AWG 8...AWG 3/0)
Number of slots	2 auxiliary switch OF plug-in) 1 alarm switch SD plug-in) 1 overcurrent trip switch SDE plug-in) 1 voltage release MN or MX plug-in)
Power wire stripping length	0.63 in (16 mm)
Color	Black
Height	6.42 in (163 mm)
Width	4.09 in (104 mm)
Depth	3.39 in (86 mm)
Net weight	4.85 lb(US) (2.2 kg)
Quantity per set	1
Phase connection	ABC
Communication interface	Modbus Ethernet
Circuit breaker application	HACR rated

Environment

Quality labels	CE
Standards	UL CSA NEMA NOM-003-SCFI-2000 IEC 60947-2
Product certifications	UL CSA NOM
IP degree of protection	Front cover IP40 IEC 60529
Pollution degree	3 IEC 60947-1
Ambient air temperature for operation	28...158 °F (-2...70 °C)
Ambient air temperature for storage	-58...185 °F (-50...85 °C)
Operating altitude	< 2000 m without derating 5000 m with derating

Packing Units

Unit Type of Package 1	PCE
Number of Units in Package 1	1
Package 1 Height	6.00 in (15.24 cm)
Package 1 Width	8.50 in (21.59 cm)
Package 1 Length	15.00 in (38.1 cm)
Package 1 Weight	5.46 lb(US) (2.475 kg)

Offer Sustainability

Sustainable offer status	Green Premium product
REACH Regulation	REACH Declaration
EU RoHS Directive	Compliant EU RoHS Declaration
Mercury free	Yes
China RoHS Regulation	China RoHS declaration Product out of China RoHS scope. Substance declaration for your information
RoHS exemption information	Yes
Environmental Disclosure	Product Environmental Profile
Circularity Profile	End of Life Information
PVC free	Yes

Contractual warranty

Warranty	18 months
----------	-----------

Dimensions

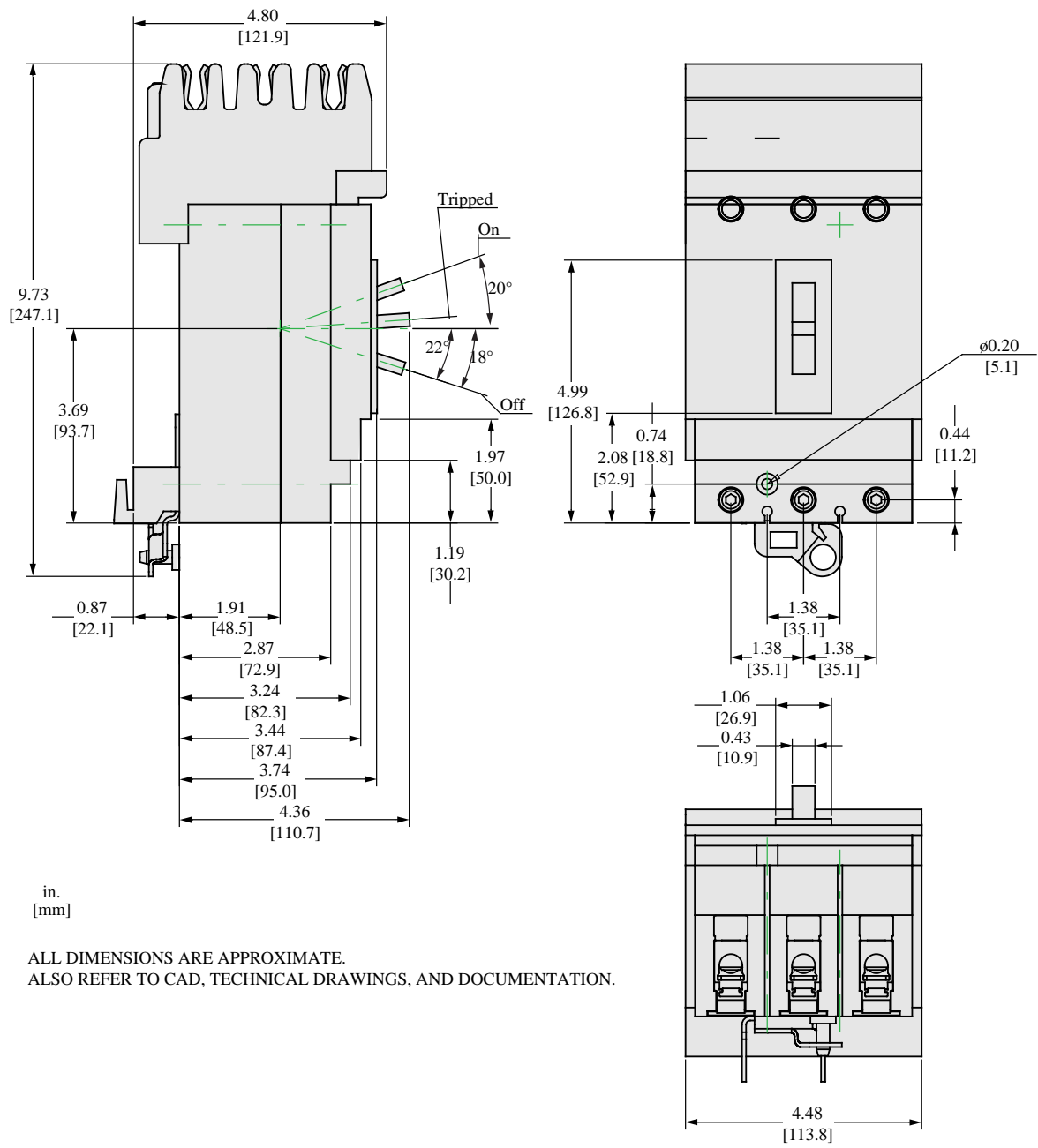

in.
[mm]

ALL DIMENSIONS ARE APPROXIMATE.
 ALSO REFER TO CAD, TECHNICAL DRAWINGS, AND DOCUMENTATION.

Recommended replacement(s)