

Heavy-Duty Safety Switch



Contents

<i>Description</i>	<i>Page</i>
Product Overview	V2-T1-3
General Duty	V2-T1-26
Heavy-Duty	
Standards and Certifications	V2-T1-32
Product Selection	V2-T1-33
Dimensions	V2-T1-42
Six-Pole Switches	V2-T1-43
Double-Throw Switches	V2-T1-45
EnviroLine—Stainless Steel Switch	V2-T1-53
EnviroLine—Upper and Lower Window Switches	V2-T1-56
EnviroLine—Receptacle Switches	V2-T1-59
EnviroLine—Non-Metallic KRYDON Switch	V2-T1-61
Shunt Trip Safety Switch	V2-T1-63
NEMA 7/9—Hazardous Location Disconnect Switch	V2-T1-66
Quick Connect Switches	V2-T1-68
Solar Disconnect Switch	V2-T1-70
316-Grade Stainless Steel Safety Switches	V2-T1-72
Mill-Duty Rated, Heavy-Duty, Fusible, Non-Fusible, Single-Throw	V2-T1-76
Heavy-Duty Fusible Safety Switches Accepting Cube Fuses	V2-T1-78
Elevator Control Switch	V2-T1-81
Auxiliary Power Heavy-Duty Safety Switch	V2-T1-83
Left-Handed Safety Switch	V2-T1-86
200% Neutral Safety Switches	V2-T1-87
Pringle Bolted Pressure Switch	V2-T1-88
Type DS, Fusible and Non-Fusible	V2-T1-91
Type Visi-Flex DE-ION	V2-T1-94
Flange Mounted—Variable Depth	V2-T1-98
Flange Mounted—Fixed Depth	V2-T1-102

Heavy-Duty

Product Description

- 30–1200A
- 600 Vac, 600 Vdc maximum
- Horsepower rated
- Fusible and non-fusible switches are 100% load break and 100% load make rated
- The continuous load current of fusible switches is not to exceed 80% of the rating of fuses employed in other than motor circuits. Non-fusible switches are 100% fully rated
- Suitable for service entrance applications unless otherwise noted
- For factory modifications, refer to **Pages V2-T1-16** through **V2-T1-19**

Application Description

For heavy commercial and industrial applications where reliable performance and service continuity are critical.

For the toughest heavy commercial and industrial applications, refer to **Page V2-T1-76** for catalog information on our mill-duty safety switch

Features, Benefits and Functions

- Deionizing arc chutes; arc chutes confine and suppress the arcs produced by opening contacts under load
- Mechanically interlocked cover to prevent easy access when the switch is in the ON position
- Clearly visible palm fitting red handle
- Complete accessory and renewal parts data shown on inner door label.
- 30–800A NEMA 12 designs convertible to NEMA 3R by opening factory-installed drain hole
- 30–1200A switches are seismic qualified and exceed the requirements of the Uniform Building Code® (UBC) and California Code Title 24
- Tri-lingual nameplates

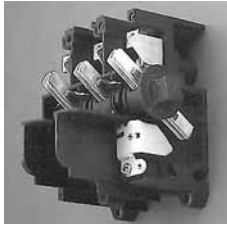

Visible Double-Break Rotary Blade Mechanism

- Two points of contact provide a positive open and close, easier operation, and also help prevent contact burning for longer contact life

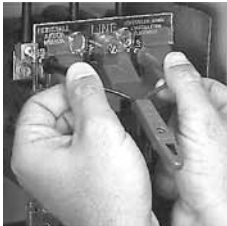

Clear Line Shield

- Protects against accidental contact with energized parts. Probe holes enable the user to test if the line side is energized without removing the shield. Not typically provided on general-duty switches, but available as a field kit or factory installed

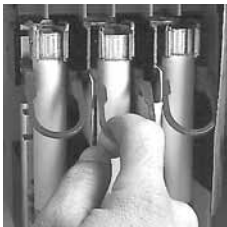

Built-In Fuse Pullers (NEMA 12 and 4X 30–200A Only)

- Provide easy removal of fuses



Clearly Visible Handle

- The position (ON or OFF) can be clearly seen from a distance and the length provides for easy operation



Triple Padlocking Capability

- Personnel safety feature because the large hasp can accommodate up to three 3/8-inch (9.5 mm) shank locks



Additional Locking Capability

- Cabinet door can be further padlocked at the top and bottom as applicable



Interlocking Mechanism

- Door cannot be opened when the handle is in the ON position. Front and side operable defeater mechanism provides for user access when necessary on single-throw switches



Tangential Knockouts

- An ample number are provided on the top, bottom and sides of both NEMA Types 1 and 3R enclosures through 200A



Bolt-On Hub Kits

- For switches in a NEMA Type 3R, 30–200A. Use a Myers type hub for all others

Standards and Certifications

- UL listed File No. E5239
- Meets UL 98 for enclosed switches and NEMA Std. KS-1



Listed

DH362NRK

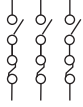
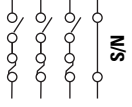
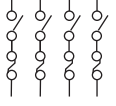

600 Vac Heavy-Duty, Fusible, Single-Throw, 277/480–600V—NEMA 1, 3R

System	Ampere Rating	Fuse Class Provision	Maximum Horsepower Ratings with Time Delay Fuses						NEMA 1 Enclosure Indoor Catalog Number	NEMA 3R Enclosure Rainproof Catalog Number
			Single-Phase AC		Three-Phase AC		DC			
			480V	600V	480V	600V	250V	600V		
Two-Pole—480 Vac—600 Vac or Vdc^① (Suitable for Service Entrance Use with a Neutral Kit Installed)										
	30	H	7-1/2	10	—	—	—	15	DH261FGK	DH261FRK
	60	H	20	25	—	—	—	25	DH262FGK	DH262FRK
	100	H	30	40	—	—	20	25	DH263FGK	DH263FRK
	200	H	50	50	—	—	40	50	DH264FGK	DH264FRK
	400	H	—	—	—	—	50	—	DH265FGK	DH265FRK
	600	H	—	—	—	—	50	—	DH266FGK	DH266FRK
	800	L	—	—	—	—	—	—	DH267FGK	DH267FRK
	1200	L	—	—	—	—	—	—	②	—
Three-Pole—480 Vac—600 Vac, 250 Vdc (Suitable for Service Entrance Use with a Neutral Kit Installed)										
	30	H	7-1/2	10	15	20	—	—	DH361FGK	DH361FRK
	60	H	20	25	30	50	—	—	DH362FGK	DH362FRK
	100	H	30	40	60	75	—	—	DH363FGK	DH363FRK
	200	H	50	50	125	150	—	—	DH364FGK	DH364FRK
	400	H	—	—	250	350	—	—	DH365FGK	DH365FRK
	600	H	—	—	400	500	—	—	DH366FGK	DH366FRK
	800	L	—	—	500	500	—	—	DH367FGK	DH367FRK
	1200	L	—	—	500	500	—	—	DH368FGK	DH368FRK
Four-Wire (Three Blades, Three Fuses, S/N) 480 Vac—600 Vac, 250 Vdc										
	30	H	7-1/2	10	15	20	—	—	DH361NGK	DH361NRK
	60	H	20	25	30	50	—	—	DH362NGK	DH362NRK
	100	H	30	40	60	75	—	—	DH363NGK	DH363NRK
	200	H	50	50	125	150	—	—	DH364NGK	DH364NRK
	400	H	—	—	250	350	—	—	DH365NGK	DH365NRK
	600	H	—	—	400	500	—	—	DH366NGK	DH366NRK
	800	L	—	—	500	500	—	—	DH367NGK	DH367NRK
	1200	L	—	—	500	500	—	—	DH368NGK	DH368NRK
Four-Pole—480 Vac—600 Vac, 250 Vdc										
	30	H	20 ^③	25 ^③	15	20	—	—	DH461FGK	④
	60	H	40 ^③	50 ^③	30	50	—	—	DH462FGK	④
	100	H	50 ^③	50 ^③	60	75	—	—	DH463FGK	④
	200	H	—	—	125	150	40	—	DH464FGK	④
	400	H	—	—	250	350	50	—	DH465FGK	②④
	600	H	—	—	400	500	—	—	DH466FGK	②④
	800	L	—	—	—	—	—	—	②	②④

Notes

- ① DC rating for 800A switches is 250V.
 - ② Contact the Safety Switch Flex Center (1-888-329-9272 or FlexSwitches@eaton.com) for availability of this product.
 - ③ Ratings are for two-phase AC.
 - ④ Use NEMA 12. NEMA 12 enclosures (30–1200A) can be field modified to meet NEMA 3R rainproof requirements when a factory provided drain hole is opened.
- 30A heavy-duty switches with Type J fuse provisions are available from the factory only. See table on **Page V2-T1-18** for catalog numbers.
- Suitable for service entrance use, except 1200A on 480Y/277 or 600Y/347 grounded wye systems, per NEC 215.10 and 230.95, and four-pole switches.

Catalog Number Selection

Quick Connect Double-Throw

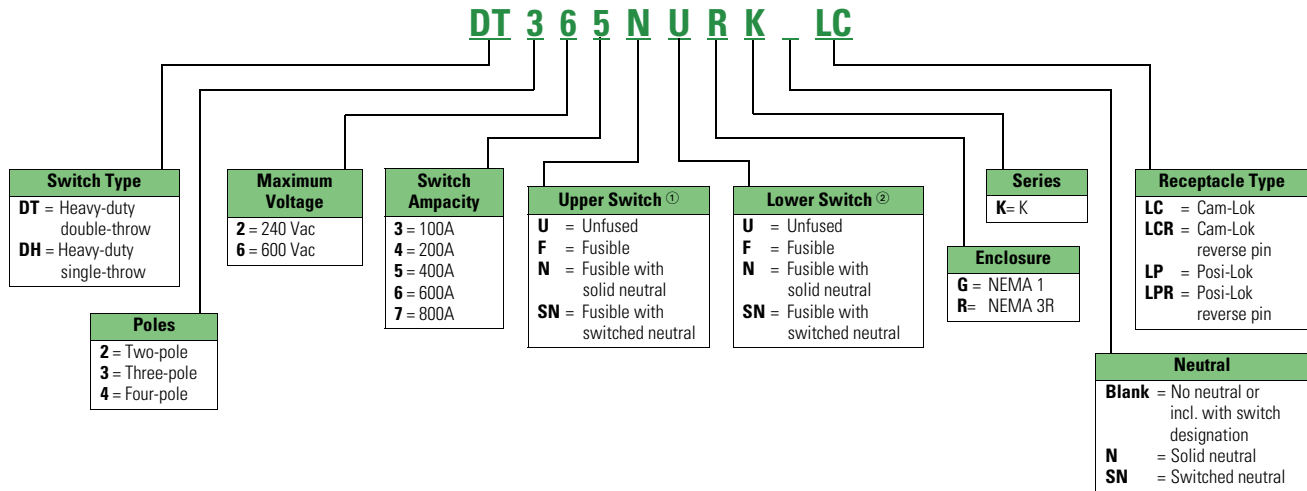

Notes

- ① When upper and lower switches are the same, the switch configuration is consolidated in one letter (e.g., "U" not "UU"). Also, a switch with a neutral will have either a solid neutral or a switched neutral, not both. Lastly, a switched neutral pole is never fused.
- ② This field is only used when a switch is completely non-fused.

This table is intended for use in breaking down existing catalog numbers. It is not intended for building new catalog numbers.