

PS ULTRA / PRO-SPRAY®

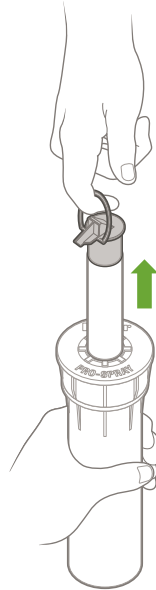

1

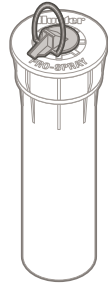

2

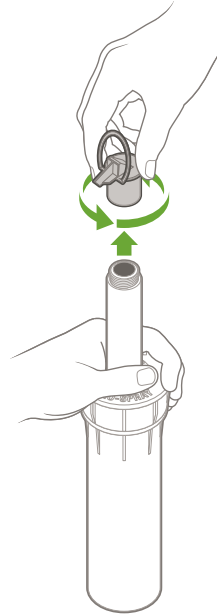

3

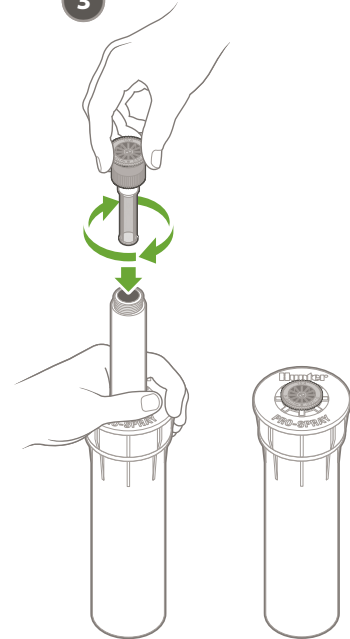

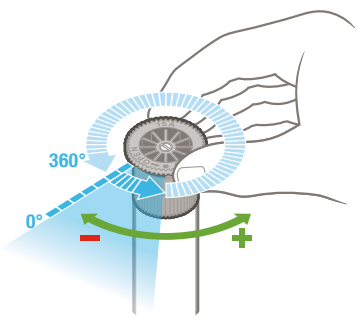
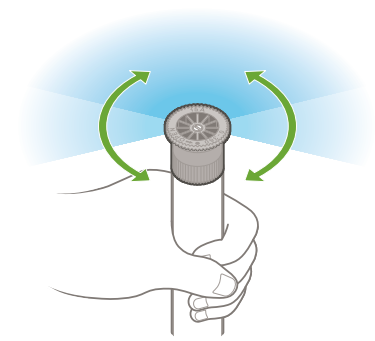
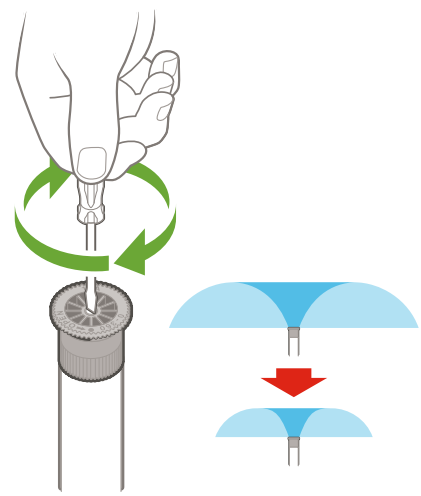
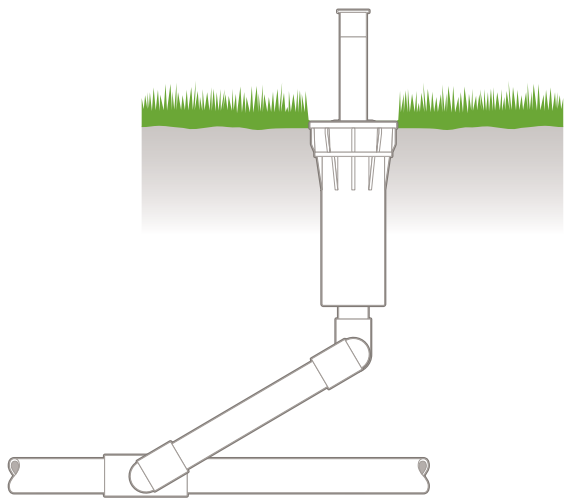



10A



1.0-3.0 Bar
100-300 kPa
20-40 PSI



0.7-9.5 l/m
0.2-2.3 GPM



2.6-3.5 m
(9'-11')



12A



1.0-3.0 Bar
100-300 kPa
20-40 PSI



0.7-13.4 l/m
0.3-3.4 GPM



3.2 m-4.1 m
(11'-13')



15A



1.0-3.0 Bar
100-300 kPa
20-40 PSI



1.3-18.0 l/m
0.4-4.5 GPM



4.0 m-5.2 m
(14'-17')



17A



1.0-3.0 Bar
100-300 kPa
20-40 PSI



1.7-21.7 l/m
0.5-5.5 GPM



4.6 m-5.8 m
(16'-19')