

此页不印刷(本文件共160页)

SIZE:100mm X 140mm

材质: 封面250g铜版纸 内页: 书纸

工艺: 封面过亚膜

注意: 不要随便删减空白页 (特别是封面内页不能出现印刷内容)

# Carplay smart screen User Manual

2.0



If you have any question of our dash cam, please contact us

**DC@yoomail.com**

we can provide solution that you can accept.

English-----	1-21
日本語-----	25-47
Deutsch-----	51-74
Español-----	78-100
Français-----	103-127
italiano-----	131-153

20240115

1.Product Overview -----	1
2.Product Composition List -----	2
3.Product Description -----	3
4.Wiring Instructions -----	4
5.Installing Reversing Camera -----	5
6.Interface Specificatify -----	6
A. Apple CarPlay -----	7
B. Android Auto -----	9
C. AirPlay -----	11
D.Android Cast -----	12
E. Bluetooth Music -----	13
F. Bluetooth -----	14
G.Audio output -----	15
H. Setting -----	18
I . Parking Line Calibration -----	20
FAQ: -----	21

# 1. Product overview

The Smart Screen Players transmitted through Bluetooth and WiFi.

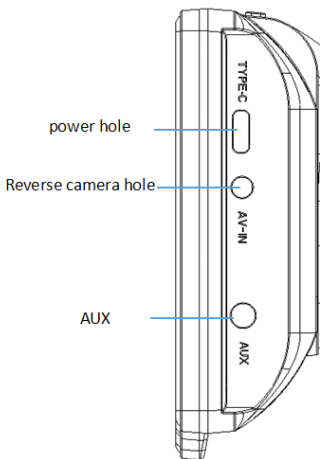

## 2. Product composition list



The host

FHD display / touch control / Bluetooth / Wi-Fi / FM Transmit / Type C interface power supply



The power cord

Type C power cord/ 5V / 3A current / integrated cable / cigar lighter to take power



Aux cable

3.5 head audio cable Connect the aux interface on the car to transmit the equipment sound to the car audio



Monitor base

To support the display and fix it on the center console



Suction Cup Mount

Install on the back of carplay screen, allow it to attach to the windshield of the vehicle

### 3. Product description

Project	Function introduction	Performance indicators
System	Language	Simplified Chinese / Traditional Chinese / English / Russian / Spanish / French / Deutsch / Japanese / Korean
	Wallpaper	Change the background wallpaper
	Factory reset	Function of restoring to factory settings
	Firmware version	Native software version
Smart + connected	Wi-Fi	Supports Apple CarPlay and Android Auto
	Bluetooth	Connect your phone to realize Carplay function
Fm Transmit	FM	FM Transmit support, connected to the car radio
Audio part	Voice control	Support voice operation function
Power part	The power input	The vehicle charging input terminal supports 12-24V wide voltage and outputs 5V/3A
Other	Working temperature	-4 ~150 °F
	The cooling way	Passive cooling



## 4. Wiring instructions

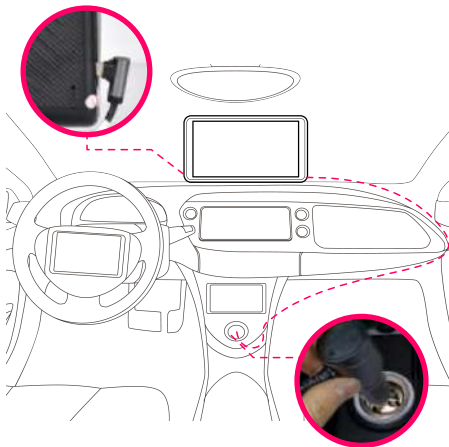

The details are as follows:

Port	Instructions
Type C interface	Monitor power supply interface
Cigarette charger	1. Note: The product has a built-in FM cigarette charger in package. Please have to use the original car charger. Other car charger may damage the carplay because of insufficient voltage and heat, FM transmitter function cannot work normally if not original car charger.

## 5.Installing reversing camera (Optional)

Confirm the position to install the reversing camera, mark the screw hole on license plate before installation. Please have to make sure drill appropriate size hole for the screw. The red wire of reversing camera have to connected to the positive lead of reversing light

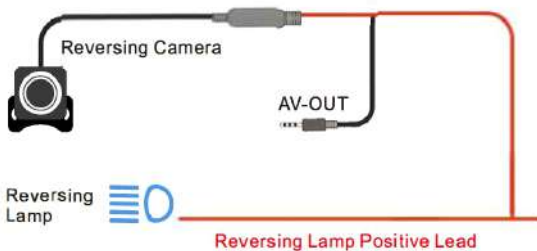

## 6. Interface Specificatify

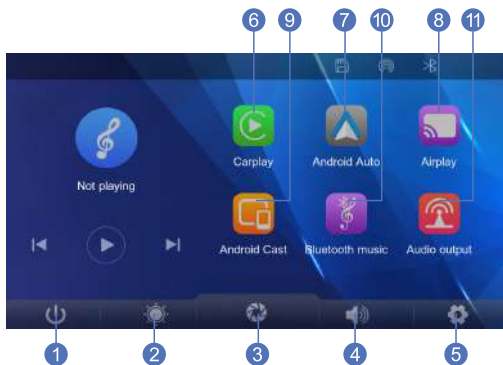

- 1. Screen ON/OFF:** Turn on and off the screen
- 2. Brightness button:** Click to adjust screen brightness
- 3. DVR:** Click to enter the video recording interface
- 4. Volume button:** Click to adjust the volume
- 5. Setting:** Click to enter the System setting interface to set the screen
- 6. Apple CarPlay:** Click to connect to the Apple Carplay of the iPhone
- 7. Android Auto:** Click to connect to the Android Auto of the Android mobile phone
- 8. Apple AirPlay:** Share videos, photos, music, and more from iPhone to the Screen
- 9. Android Cast:** Share videos, photos, music, and more from Android phones to the Screen
- 10. Bluetooth music:** Use your mobile phone to connect to a Bluetooth device and play music.
- 11. Audio output:** Click to select the sound playing mode

## A. Apple CarPlay



As shown in the figure, click the [Apple CarPlay] button to enter the Apple CarPlay. Turn on the Wi-Fi and Bluetooth of the mobile phone first, then as shown in the figure below, select the [Apple CarPlay] option, click the [BT Manage] option of the interface, connect Bluetooth with the phone, you can open the application. When the machine is powered on, it will try to automatically connect to the last connected phone.

**(Turn off your phone's Wi-Fi to disconnect, Apple CarPlay option only supports iPhone phones, Android phone please select [Android auto] option)**

**(The specific connection method is as follows)**

### 1. Open Carplay



## 2. Turn on the Bluetooth and WiFi switch on the mobile phone



## 3. Find the t86 xxxxx device name in other devices, Use CarPlay

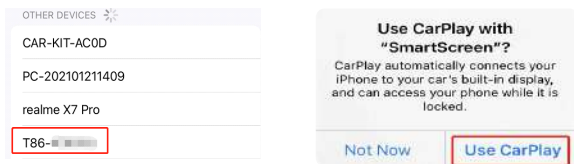

## 4. Connection successful

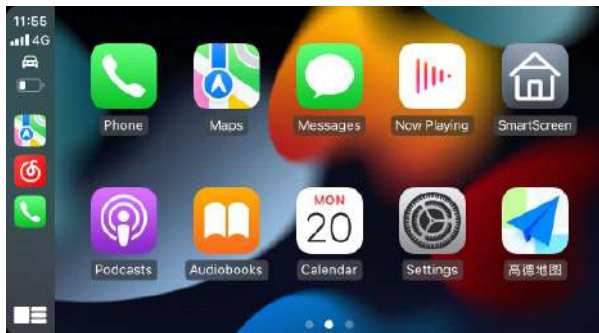

Tips: Hey, Siri, wake up your phone, listen to music, make phone calls, navigate, check the weather, etc. through your device

## B. Android Auto

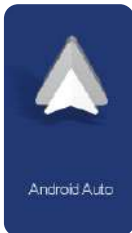

As shown in the figure, click the [Android Auto] button to enter the Android auto. Turn on the Wi-Fi and Bluetooth of the mobile phone first, then as shown in the figure below, select the [Android auto] option, click the [BT Manage] option of the interface, connect Bluetooth with the phone, you can open the application. When the machine is powered on, it will try to automatically connect to the last connected phone.

**(Turn off your phone's Wi-Fi to disconnect)**

1. Open Android Auto



2. To use Android Auto, Google Pixels phone needs to Android 8.0 or above.
3. For Android phones from other brand, the system needs to be Android 11 or above.

4. After connecting the Bluetooth device, it will automatically connect to the WiFi, please do not manually connect to the WiFi device again.

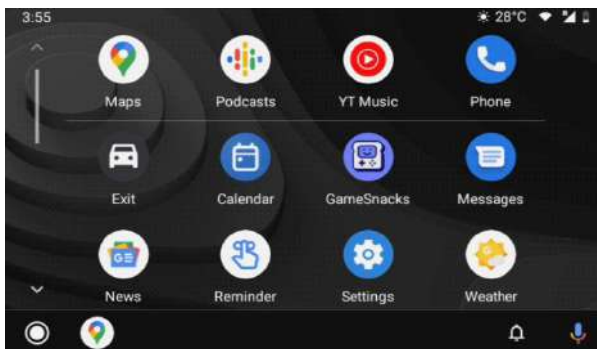

**Note:** Some Android phones may have wireless connection problems because different brands and system versions. So we offer wired connection for Android phone

**Method:** There has a usb port on the car charger cable, you can connect your Android phone to the usb port by your original phone data cable

## C. AirPlay



Airplay supports transfer video, audio and pictures from iPhone to carplay by WiFi function.

Steps:

1. Require your iPhone connect to Carplay's WiFi
2. Select SmartScreen in Screen Mirroring in the iPhone Control Center

**Note:** Supports iPhone phones only



## D.Android Cast



It can realize the mirror projection of the mobile phone and the car machine.

You need to scan the code with your mobile phone to download, install and run the "TcLink" application.



**Note: Only supports Android phones(The mobile phone must support the WIFI direct connection function)**

## E. Bluetooth Music

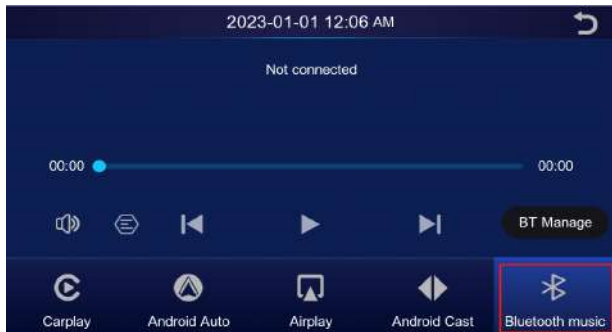

You can find Bluetooth Music by clicking the button Apple CarPlay or Android Auto. Turn on Bluetooth of the mobile phone first, and select [Bluetooth Music] option. Click the [BT Manage] option on the interface to connect Bluetooth to the mobile phone and start playing music.

The buttons correspond to Last, Play / Pause and Next, respectively.





Click on the Lyrics button [  ] to display the lyrics.

**(Some mobile music player apps do not support displaying lyrics)**

## F. Bluetooth



As shown in the figure above, click the Bluetooth button [  ] to switch on the device after entering the Bluetooth interface.

The page will display the device name, such as: T86-1xxxxx, and click the Modify button [  ] to modify the Bluetooth name of the device. Select the device name with Bluetooth, and the remote device name of the phone will appear after successfully connecting.

At this time, you can play mobile phone music and other functions. After connecting to Bluetooth, you can use the call function:

Click the Disconnect button [  ] to actively disconnect the Bluetooth.

# G.Audio output



Audio output

1. Speaker output

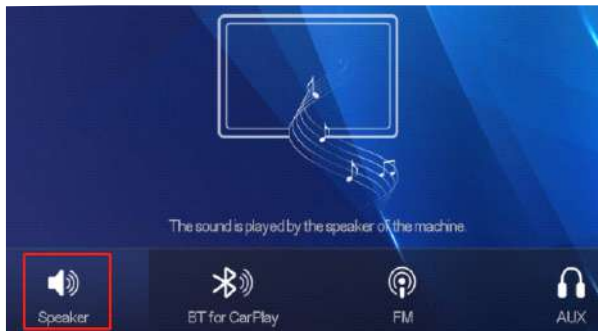

2. BT output:



### 3.FM output



As shown in the figure, click the [FM Transmit] button to enter the FM Transmit function: it can emit the sound of the equipment, receive it with the original car radio, and play it through the original car horn, enjoying the original car level. When you turn on the FM Transmit option, the monitor will no longer emit any sound. At this time, you need to turn off the FM Transmit or match the sound to the car's builtin stereo to have sound.

**(Not using the original power cord will cause the FM Transmit signal to deteriorate or the function cannot be used.)**

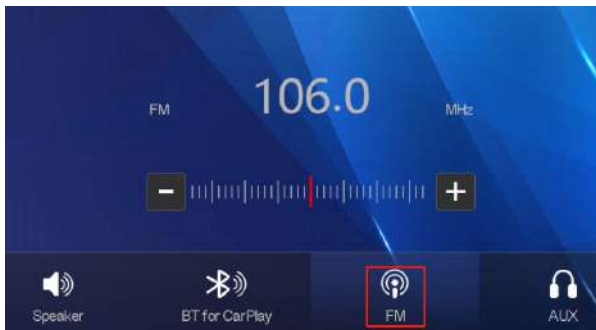

1. Selects the frequency band to be emitted, for example, the FM 106.0 MHz.
  2. Car radio also adjusts the acceptance band to FM 106.0 MHz.
  3. Car radio can connect to the FM Transmit signal of the upper system.
- After the FM launch connection is successful, all sounds will be sent to the original car speaker for play.

(Recommended FM: 100-108MHz)







#### 4.AUX output:





## H.Setting





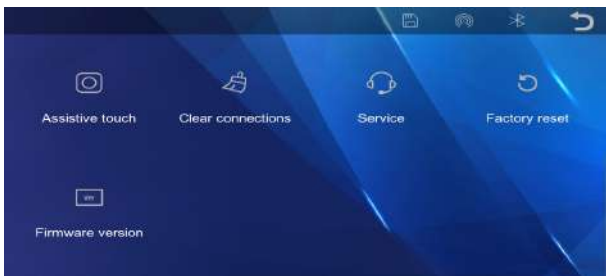

As shown in the figure, click the [  ] button in the lower left corner to enter the setting interface

Icon	specification
	Click [Reminder tone] Tap to turn off/on the touch and boot sound
	Image Mirror: On/Off The rear camera supports horizontal mirror flip
	Options: On/Off You can adjust the reversing lines, please check the instruction details in next page
	Options: Off /10S/30S/1 min The screen will turns off after 10S/30S/1 min if no operation, press the power button to turn on the screen
	Wallpaper: Change the main interface wall paper
	Click [Auto-dimming] Turn on/off eye protection mode and set night screen brightness

	<p>Click [Driving Position] to enter the setting: You can select left rudder or right rudder. In the shortcut menu bar of Apple CarPlay, select left rudder on the left, and select right rudder on the right.</p>
	<p>Options: Simplified Chinese/Traditional Chinese / English / Russian / Spanish / French / German / Japanese / Korean</p>



	<p>Click [Assistive touch] to turn on/off the Float Button on the screen.</p>
	<p>Click [Clear Connections] to clear the Wi-Fi and Bluetooth records connected to the mobile phone.</p>
	<p>Click [Service] please use your mobile phone to scan the QR code to obtain online services</p>
	<p>Factory Reset: Restore the factory settings</p>
	<p>Firmware version: Confirm the system firmware version</p>



## I. Parking Line Calibration

Click [Calibration] to enter the settings:

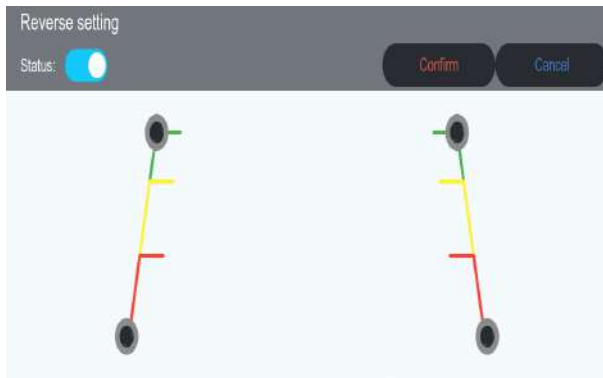

Park the car in the middle of the parking space.



Hold the X to adjust the reversing line position and angle, please make sure the parking line is horizontal of the ground.



Click [ confirm ] to save the calibration.

## FAQ:

1. Because the output current is unstable when the car starting, please turn off the FM before stopping the car, otherwise the FM will make noise when you starting the car again.
2. When you use the FM to connect the carplay, please don't use the same frequency as the broadcast, otherwise the carplay will be frequency bumping and no sound. you can use the AUX cable to connect the carplay, which can effectively solve this problem.
3. Some Android phones may have wireless connection problems because different brands and system versions. So we offer wired connection for Android phone.  
Method: There has a usb port on the car charger cable, you can connect your Android phone to the usb port by your original phone data cable.
5. Before connecting again, please turn on Bluetooth and WIFI, the system will auto connection your mobile phone.
6. Please according our suggested to connect the power circuit, and avoid interference when the machine is started.



# 日本語説明書

# 日本語説明書

こちらは24時間以内に返信して、問題をできるだけ早く解決するために全力を尽くします。お客様は弊店の製品にご不満のところございましたら、ご感想をお聞かせてください。こちらが是非誠心誠意で対応させていただきます!どうぞよろしくお願い申し上げます。

**DC@yoomail.com**

1. インターフェイスと各ボタン機能	27
2. セット内容	28
3. 機能説明	29
4. 取り付け手順	30
5. リアカメラの取り付け(オプション)	31
6. 画面説明	32
A. Apple CarPlay	33
B. Android Auto	35
C. AirPlay	37
D. Android Cast	38
E. Bluetooth 音楽	39
F. Bluetooth	40
G. オーディオ出力	41
H. 設定	44
I. 駐車補助線校正	46
よくある質問と対策	47

## 1.インターフェイスと各ボタン機能

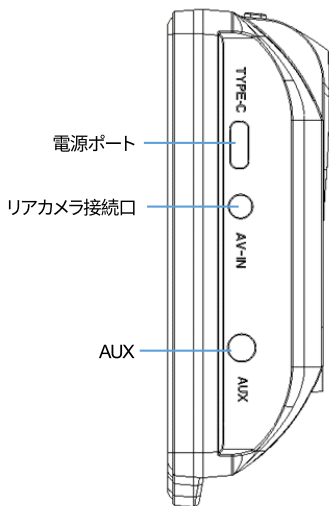



## 2.セット内容



本体

FHDディスプレイ/タッチスクリーン/  
Bluetooth/Wifi/FM送信/Type-C電源をサポート.



シガーライター

5V/3A 電流Type-C充電ポート.



3.5mmオー  
ディオケーブル

3.5mmオーディオケーブル:車のAUXポートに接続して、  
carplayサウンドをカーステレオに送信します.



粘着スタンド

Carplayを車に固定します.



吸盤ホルダー

吸盤ホルダーをカープレイの裏側に固定し、吸盤を  
自動車のフロントガラスに吸着させます.

### 3.機能説明

	機能	説明
設定	言語	簡体字中国語/繁体字中国語/英語/ロシア語/ スペイン語/フランス語/ドイツ語/日本語/韓国語
	壁紙	カープレイ壁紙を変更
	初期化	工場出荷時の設定を復元ます
	バージョン	ソフトウェアバージョン
CarPlay 接続	Wifi	Apple CarPlay and Android Auto
	Bluetooth	スマホンを接続して、Carplay機能を対応
FM放送	FM	FMをサポートし、カーラジオを接続します
オーデ ィオ	マイク	マイク録音をサポートします
	音声コントロ ール	音声コントロールをサポートします
オーデ ィオ	シガーライター	入力は12~24V電圧対応、出力5V/3A
ほか	操作温度範囲	-4~150 °F

## 4.取り付け手順

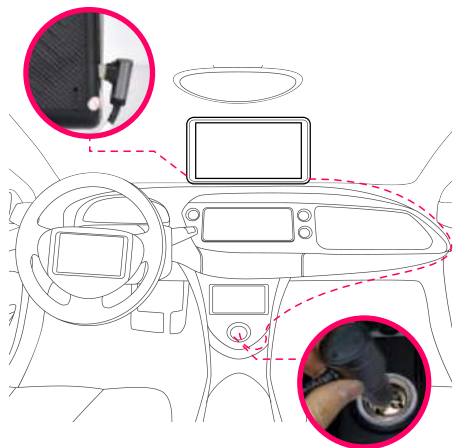

接続口	説明
Type-C電源コード	Carplay電源ポートを接続します
シガレット電源コード	注:1.オリジナルのシガーアダプターを使用してください 他社のシガーアダプターでは電圧不足や発熱でカープレイが破損する恐れがあります、オリジナルのシガーアダプターを使用しない場合、FM送信機能が正常に動作しません

## 5.リアカメラの取り付け(オプション)

ナンバープレートの近くに適切な取り付け位置を見つけ、穴あけ位置を決定し、ペンで印を付けてから、適切なサイズのネジ穴を開けます。ネジを使用してリアカメラを車の後部に固定します。リバースセンサーのワイヤーをバックライトのプラス極(赤色の細いワイヤー)に接続し、最後にカープレイをリアカメラの延長線に接続します。

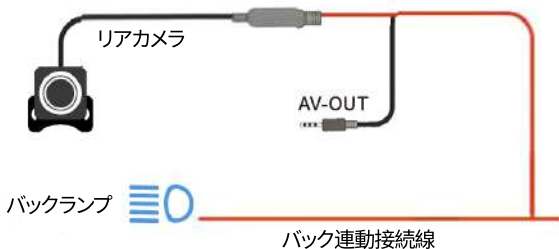
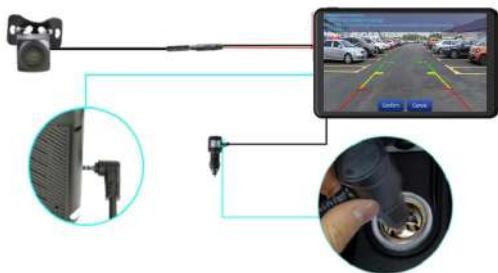

## 6.画面説明



- 1.画面オン/オフ:** 画面のオンとオフを切り替えます
- 2.明るさボタン:** クリックして画面の明るさを調整します
- 3.カメラ:** カメラの画面を確認する
- 4.音量:** クリックして音量を調整します
- 5.設定:** クリックして設定ページに入ります
- 6.Apple Carplay:** iPhoneスマホと接続専用APP
- 7.Android Auto:** Android スマホと接続専用APP
- 8.AirPlay:** iPhoneのみミラーリング
- 9.Android Cast:** Android すまほん用スマホミラーリング
- 10.Bluetooth 音楽:** 携帯電話を使用して Bluetooth デバイスに接続し、音楽を再生します
- 11.オーディオ出力:** クリックしてオーディオ出力モードを選択できます

## A. Apple CarPlay



1. 図のように[Apple CarPlay]ボタンをクリックして Apple CarPlayに入ります。
2. スマホのwifiとBluetooth をオンにして、下の図に示すように[Apple CarPlay] を選択し、CarPlayインターフェイスの [Bluetooth管理] オプションをクリックして、Bluetooth とスマホにリンクが成功しました。
3. 次にcarplayをオンにした時、システムがスマホを記憶し、カーオーディオが自動的に接続されます。

(スマホのWi-Fi をオフにして切断します。Apple CarPlay オプションはiPhone スマホのみをサポートし、Android スマホは[Android auto] オプションを選択してください)；

スマホの具体的な接続方法は以下：

### 1.Carplay をオンにします



2. BluetoothとWiFiスイッチをオンにします;

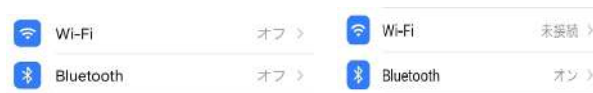

3. スマホを使用してBluetoothに接続します、Bluetoothの名前は:T86-XXXX



4.リンクが成功しました



PS: Hei, Siri! iPhoneを呼び覚まして、音楽を聴いて、電話をかけて、ナビゲーションして、天気など、音声アシスタントを利用して、carplayを制御します。

## B. Android Auto

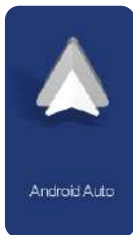

1. 図のように[Android Auto]ボタンをクリックして Android Autoに入ります。
2. スマホのwifiとBluetooth をオンにして、下の図に示すように[Android Auto] を選択し、CarPlayインターフェイスの [Bluetooth管理] オプションをクリックして、Bluetoothとスマホにリンクが成功しました。
3. 次にcarplayをオンにした時、システムがスマホを記憶し、カーオーディオが自動的に接続されます。スマホのWi-Fi をオフにして切断します。

Android AutoオプションはAndroidスマホのみをサポートします。

1.スマホの具体的な接続方法は以下:

1.Android Auto をオンにします





- 2.Android Autoを使用する場合、Google Pixel smartphoneにはAndroid 8.0以上のバージョンが必要です。
- 3.他のブランドのAndroidスマホでは、システムはAndroid 11以上のバージョンが必要です。
- 4.Bluetooth デバイスを接続すると、WiFi は自動的に接続されます。WiFi デバイスを手動で再接続しないでください。



注:一部のAndroid スマホは、ブランドやシステムのバージョンが異なるため、ワイヤレス接続に失敗する場合があります。そのため、Android スマホの有線接続データケーブルを提供しています。

解決方法:車の充電ケーブルにUSBポートがあり、オリジナルのスマホデータケーブルを使用して、Android スマホをカープレイに接続できます。

## C. AirPlay



Airplay は、WiFi 機能を通じてiPhone のビデオ、オーディオ、写真をカーブレイに転送することをサポートしています。

ステップ1. iPhone をCarplay のWiFi に接続する必要があります

ステップ2. iPhoneコントロールセンターの画面ミラーリングでSmartScreenを選択します。

注: iPhone のみがサポートされています。

## D.Android Cast



スマホやカープレイのミラー投影を実現できます。  
もし「TcLink」アプリケーションをダウンロードが必要であれば、スマホでQRコードをスキャンしてください。



注: Android スマホのみがサポートされています (スマホはWIFI 直接接続機能をサポートしている必要があります)。

## E. Bluetooth音楽



1. Apple CarPlay または Android Auto をクリックして、Bluetooth 音楽オプションを見つけます。[Bluetooth管理] をクリックして、デバイス名を確認してください。
2. スマホのWiFi をオフにし、スマホのBluetooth をオンにして、[Bluetooth 音楽のデバイス名前] を選択します。
3. Bluetooth を携帯電話に接続して、音楽の再生を開始します。



これらのボタンは、[前へ]、[再生/一時停止]、および[次へ]に対応しています  
歌詞ボタン[  ]をクリックすると、歌詞が表示されます。

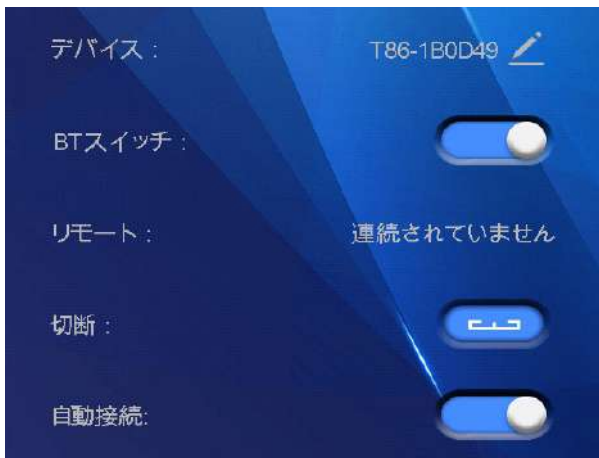

(マホの音楽プレイヤーアプリは歌詞表示に対応していません)

## F. Bluetooth



- 1.上の図に示すように、Bluetooth インターフェイスに入ったら、BT スイッチボタン  をクリックしてBluetooth をオンにします。
- 2.ページには、T86-xxxx のようなデバイス名が表示されます。変更ボタン[  ] をクリックして、デバイスのBluetooth 名を変更します。
- 3.スマホにBluetooth でデバイス名を選択し、接続が成功すると、スマホのリモートデバイス名がcarplay ページに表示されます。
- 4.接続が成功すると、携帯電話の音楽を再生できます。通話機能もご利用いただけます。
- 5.切断ボタン[  ] をクリックして、Bluetooth 接続を切断します。

## G.オーディオ出力



オーディオ出力

### 1.スピーカ出力



### 2.BT出力



### 3.FM出力



1.図に示すように、[FM放送] ボタンをクリックしてFM送信機能に入ります。

2.carplayから音声を発信し、元車ラジオで受信し、元車スピーカーで再生し、元の車のレベルを楽しむことができます。

3.FM送信オプションをオンにして、リンクが成功しない場合、carplayは音を出しません。この時点で、FM送信をオフにするか、carplayを車の内蔵オーディオとリンクさせて音を出す必要があります。

(付属の電源コードを使用しないと、FM送信信号が弱くなったり、機能が使用できなくなります。)



1. 送信する周波数帯域を選択します(例: FM 106.0 MHz)。
2. カーラジオも受信周波数帯域をFM 106.0 MHzに調整します。
3. カーラジオはcarplayのFM送信に接続できます。

Fm送信が正常に接続されると、すべてのサウンドが元車のスピーカーに送信されて再生されます。

#### 4.AUX出力











## H.設定







図に示すように、[  ] ボタンをクリックして設定インターフェイスに入ります。

Icon	specification
	キュートーン:「キュートーン」をクリックして、タッチと起動音がオフ/オンになります
	鏡像:オン/オフ リアカメラの画像をミラーまたは元の画像に切り替えます
	オプション:オン/オフ 駐車補助線は調整可、詳しくは次ページをご覧ください
	オプション:オフ/10S/30S/1分 スクリーンセーバーはオフ/10S/30S/1分を選択して、設定した時間に応じて画面が黒くなり、消費電力を節約できます。電源ボタンを押して画面をオンにします
	壁紙:壁紙を変更します
	ナイトモード: オプション: オン/オフ;夜間の画面輝度を設定できます。

	<p>[ドライビングポジション]をクリックして設定を入力します: 左舵または右舵を選択できます。Apple CarPlayのショートカットメニューバーで、左側で左舵を選択し、右側で右舵を選択します。</p>
	<p>言語オプション: 簡体字中国語/繁体字中国語/英語/ロシア語/スペイン語/フランス語/ドイツ語/日本語/韓国語</p>



	<p>[補助ボタン]をクリックしてオン/オフを切り替えます</p>
	<p>[接続の消去]をクリックして、スマホとの接続記録 (Bluetooth、WIFI名とパスワード)をクリアします</p>
	<p>[サービス]をクリックし、スマホでQRコードをスキャンしてオンラインサービスをご利用ください。</p>
	<p>リセット:工場出荷時の設定を復元します</p>
	<p>バージョン:システムのバージョンを確認します</p>

## 1. 駐車補助線校正

[校正] をクリックして設定して:

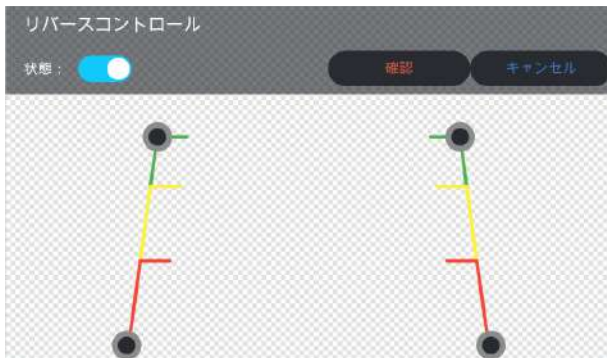

駐車スペースの真ん中に車を止めます。



Xを長押しして駐車補助線の位置と角度を調整し、駐車線が地面と水平であることを確認します。



[確認] をクリックして設定データを保存します。

## よくある質問と対策

1. FM が carplay に接続されている場合、ラジオ局と同じ周波数を使用しないでください。AUX ケーブルを使用してカープレイを接続すると、ノイズの問題を効果的に解決できます。

2. Apple CarPlay/Android Auto を接続した後、2 回目に電源を入れるときは 10 ～ 20 秒待ってください。CarPlay が自動的にスマホに接続します。

3. 再度接続する前に、Bluetooth と WIFI をオンにしてください。システムは自動的に電話を接続します。

4. カープレイがオンになっているときは、干渉を避けるために弊社電源コードを使用してください。

5. 注: 一部の Android スマホは、ブランドやシステムのバージョンが異なるため、ワイヤレス接続に失敗する場合があります。そのため、Android スマホの有線接続データケーブルを提供しています。

解決方法: 車の充電ケーブルに USB ポートがあり、オリジナルのスマホデータケーブルを使用して、Android スマホをカープレイに接続できます。



# Deutsches Handbuch

# Deutsches Handbuch

Wenn Sie Fragen zu unserer Dashcam haben, kontaktieren Sie uns bitte

**[DC@yoomail.com](mailto:DC@yoomail.com)**

Wir können eine Lösung anbieten, die Sie akzeptieren können.



1. Produktübersicht -----	53
2. Liste der Produktzusammensetzung -----	54
Der Gastgeber	
3. Produktbeschreibung -----	55
4. Verdrahtungshinweise -----	57
5. Rückfahrkamera installieren (optional) -----	58
6. Schnittstellenspezifikationen -----	59
A. Apple CarPlay -----	60
B. Android Auto -----	62
C. Apple-AirPlay -----	64
D. Android Cast -----	65
E. Bluetooth-Musik -----	66
F. Bluetooth -----	67
G. Audioausgabe -----	68
H. Einstellung -----	71
I. Parklinien Kalibrierung -----	73
FAQ: -----	74

# 1. Produktübersicht

Die Smart Screen Player werden über Bluetooth übertragen und WLAN.

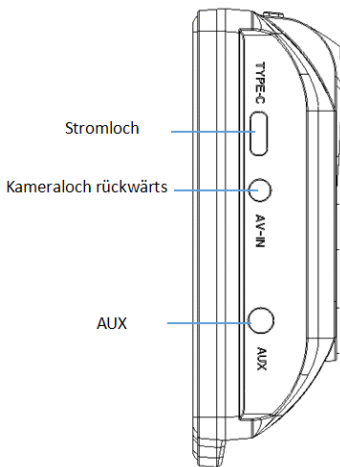

## 2. Liste der Produktzusammensetzung Der Gastgeber



Der Gastgeber

FHD-Display / Touch  
Steuerung / Bluetooth / Wi-Fi / FM-Übertragung /  
Typ-C-Schnittstellennetzteil



Das Netzkabel

Netzkabel Typ C / 5 V / 3 A Strom /  
integriertes Kabel / Zigarettenanzünder zur  
Stromaufnahme



AUX-Kabel

3,5-Kopf-Audiokabel Schließen Sie das Aux  
Schnittstelle am Auto zur Übertragung der  
Gerätesound zum Autoradio



Basis überwachen

Um das Display zu stützen und auf dem  
zu befestigenMittelkonsole



Saugnapfhalterung

Installieren Sie es auf der Rückseite des  
Carplay-Bildschirms und lassen Sie es an der  
Windschutzscheibe des Fahrzeugs befestigen

### 3. Produktbeschreibung

Projekt	Funktionseinführung	Leistungskennzahl
System	Sprache	Vereinfachtes Chinesisch / Traditionelles Chinesisch /Englisch / Russisch / Spanisch / Französisch / Deutsch / Japanisch / Koreanisch
	Hintergrund	Ändern Sie das Hintergrundbild
	Werkseinstellungen zurückgesetzt	Funktion zum Wiederherstellen der Werkseinstellungen
	Firmware Version	Native Softwareversion
Smart + verbunden	W-lan	Unterstützt Apple CarPlay und Android Auto
	Bluetooth	Schließen Sie Ihr Telefon an, um die Carplay-Funktion zu realisieren
FM-Senden	FM	FM-Übertragungsunterstützung, verbunden mit dem Autoradio
Audioteil	Stimmenkontrolle	Unterstützt die Sprachbedienungsfunktion

Leistungsteil	Die Leistungsaufnahme	Der Fahrzeugladeeingangsanschluss unterstützt eine Spannung von 12–24 V und gibt 5 V/3 A aus
Andere	Arbeitstemperatur	-4 ~150 °F
	Der kühlende Weg	Passive Kühlung

## 4. Verdrachtungshinweise

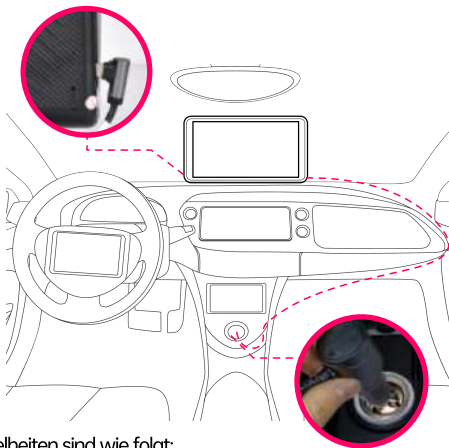

Die Einzelheiten sind wie folgt:

Hafen	Anweisungen
Typ-C-Schnittstelle	Stromversorgungsschnittstelle überwachen
Zigarettenladegerät	1. Hinweis: Das Produkt verfügt über ein integriertes FM-Zigarettenladegerät im Lieferumfang. Bitte verwenden Sie das Original-Autoladegerät. Andere Autoladegeräte können das Carplay aufgrund unzureichender Spannung und Hitze beschädigen, die FM-Senderfunktion kann nicht normal funktionieren, wenn es sich nicht um ein Original-Autoladegerät handelt

## 5. Rückfahrkamera installieren (optional)

Bohrloch ausfindig machen, die passende Einbauposition in der Kennzeichenbefestigung finden, mit einem Stift markieren und dann das Schraubloch in der passenden Größe bohren. Befestigen Sie die Kamera mit Schrauben an der Rückseite des Autos, das Rückfahrauslösekabel (rotes dünnes Kabel) muss mit dem Pluspol des Rückfahrlichts verbunden werden, und verwenden Sie schließlich das Kameraverlängerungskabel, um eine Verbindung zum Monitor herzustellen.

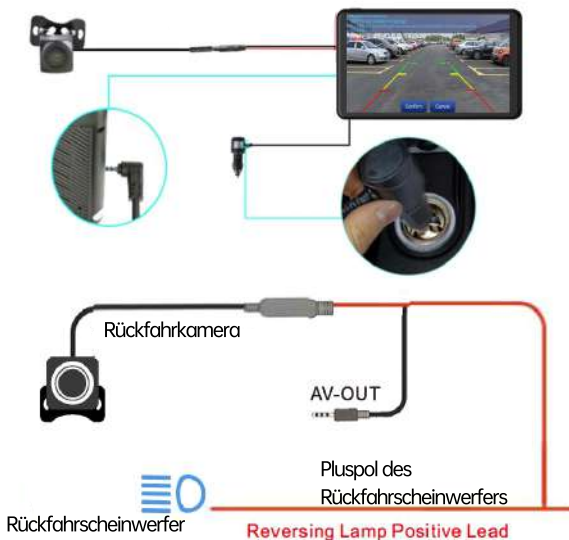

## 6. Schnittstellenspezifikationen



- 1. Bildschirm EIN/AUS:** Schaltet den Bildschirm ein und aus
- 2. Helligkeitstaste:** Klicken Sie hier, um die Bildschirmhelligkeit anzupassen
- 3. DVR:** Klicken Sie hier, um die Videoaufzeichnungsoberfläche aufzurufen
- 4. Lautstärketaste:** Klicken Sie hier, um die Lautstärke anzupassen
- 5. Einstellung:** Klicken Sie hier, um die Systemeinstellungsoberfläche aufzurufen und den Bildschirm einzustellen
- 6. Apple CarPlay:** Klicken Sie hier, um eine Verbindung zum Apple CarPlay des iPhone herzustellen
- 7. Android Auto:** Klicken Sie hier, um eine Verbindung zu Android Auto des Android-Mobiltelefons herzustellen
- 8. Apple AirPlay:** Teilen Sie Videos, Fotos, Musik und mehr vom iPhone auf dem Bildschirm
- 9. Android Cast:** Teilen Sie Videos, Fotos, Musik und mehr vom Android-Telefon auf dem Bildschirm
- 10. Bluetooth-Musik:** Verwenden Sie Ihr Mobiltelefon, um eine Verbindung zu einem Bluetooth-Gerät herzustellen und Musik abzuspielen.
- 11. Audioausgabe:** Klicken Sie, um den Tonwiedergabemodus auszuwählen



# A. Apple CarPlay



Wie in der Abbildung gezeigt, klicken Sie auf die Schaltfläche [Apple CarPlay], um Apple CarPlay aufzurufen. Schalten Sie zuerst Wi-Fi und Bluetooth des Mobiltelefons ein, wählen Sie dann, wie in der Abbildung unten gezeigt, die Option [Apple CarPlay], klicken Sie auf die Option [BT Manage] der Schnittstelle, verbinden Sie Bluetooth mit dem Telefon, Sie können es öffnen die Anwendung. Wenn das Gerät eingeschaltet wird, versucht es, sich automatisch mit dem zuletzt verbundenen Telefon zu verbinden.

**(Schalten Sie das WLAN Ihres Telefons aus, um die Verbindung zu trennen, die Apple CarPlay-Option unterstützt nur iPhone-Telefone, Android-Telefone wählen Sie bitte die Option [Android Auto]) (Die spezifische Verbindungsmethode ist wie folgt) (Die spezifische Verbindungsmethode ist wie folgt)**

## 1. Öffnen Sie Carplay



## 2. Schalten Sie den Bluetooth- und WLAN-Schalter am Mobiltelefon ein

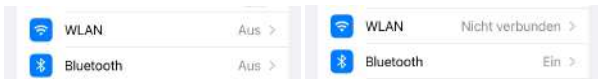

## 3. Finden Sie den t86 xxxxx Gerätenamen in anderen Geräten, Verwenden Sie CarPlay

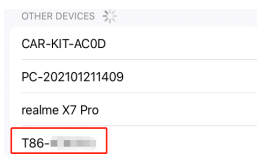

## 4. Verbindung erfolgreich



Tipps: Hey, Siri, wecke dein Handy auf, höre Musik, telefoniere, Navigieren Sie, überprüfen Sie das Wetter usw. über Ihr Gerät.

## B. Android Auto



Klicken Sie wie in der Abbildung gezeigt auf die Schaltfläche [Android Auto], um das Android Auto einzugeben. Schalten Sie das WLAN ein und Bluetooth des Mobiltelefons zuerst, dann wie in gezeigt Abbildung unten, wählen Sie die Option [Android Auto], klicken Sie auf die Option [BTManage] der Schnittstelle, verbinden Bluetooth mit dem Telefon können Sie die Anwendung öffnen. Wenn das Gerät eingeschaltet wird, wird es versuchen automatisch mit dem zuletzt verbundenen Telefon verbinden..

**(Schalten Sie das WLAN Ihres Telefons aus, um die Verbindung zu trennen)**

1. Öffnen Sie Android Auto



2. Um Android Auto zu verwenden, muss das Google Pixel-Telefon Android 8.0 oder höher haben.
3. Für Android-Telefone anderer Marken muss das System Android 11 sein oder höher.

4. Nach dem Anschließen des Bluetooth-Geräts wird automatisch eine Verbindung hergestellt Bitte verbinden Sie sich nicht erneut manuell mit dem WLAN-Gerät.

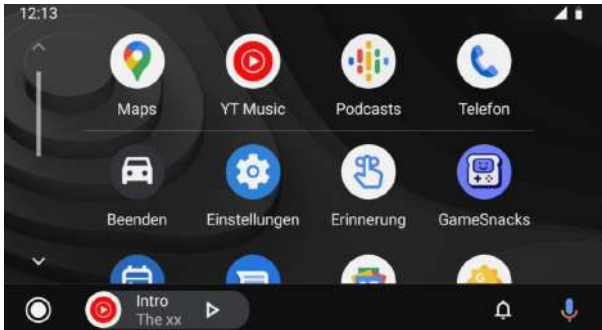

**Hinweis:** Bei einigen Android-Telefonen können aufgrund unterschiedlicher Marken und Systemversionen Probleme mit der drahtlosen Verbindung auftreten. Daher bieten wir eine kabelgebundene Verbindung für Android-Telefone an.

**Methode:** Das Autoladekabel verfügt über einen USB-Anschluss. Sie können Ihr Android-Telefon über Ihr Original-Telefondatenkabel mit dem USB-Anschluss verbinden.

## C. Apple-AirPlay



Apple Airplay unterstützt die Übertragung von Video, Audio und Bildern vom iPhone auf Carplay per WiFi-Funktion.

Schritte:

1. Fordern Sie Ihr iPhone auf, sich mit dem WLAN von Carplay zu verbinden
  2. Wählen Sie SmartScreen unter Screen Mirroring im iPhone Control Center
- Hinweis: Unterstützt nur iPhone-Telefone.

## D.Android Cast



Es kann die Spiegelprojektion des Mobiltelefons und der Automaschine realisieren. Sie müssen den Code mit Ihrem Mobiltelefon scannen, um die Anwendung „TcLink“ herunterzuladen, zu installieren und auszuführen.



Hinweis: Unterstützt nur Android-Telefone (Das Mobiltelefon muss die WIFI-Direktverbindungsfunktion unterstützen)

## E. Bluetooth-Musik

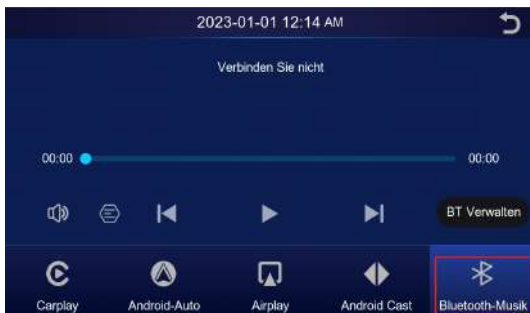

Sie finden Bluetooth Music, indem Sie auf die Schaltfläche Apple CarPlay oder klicken Android Auto. Schalten Sie zuerst Bluetooth am Mobiltelefon ein und wählen Sie aus Option [Bluetooth-Musik]. Klicken Sie in der Benutzeroberfläche auf die Option [BTManage]. Verbinden Sie Bluetooth mit dem Mobiltelefon und starten Sie die Musikwiedergabe.

Die Schaltflächen entsprechen jeweils Last, Play / Pause und Next.





Klicken Sie auf die Liedtext-Schaltfläche [  ], um den Liedtext anzuzeigen.

**(Einige mobile Musikplayer-Apps unterstützen die Anzeige von Liedtexten nicht.)**

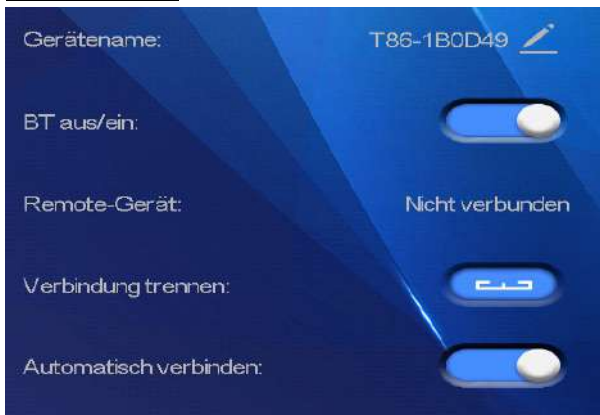
## F. Bluetooth



Klicken Sie, wie in der obigen Abbildung gezeigt, auf die Bluetooth-Schaltfläche [  ], um Schalten Sie das Gerät ein, nachdem Sie die Bluetooth-Schnittstelle aufgerufen haben. Auf der Seite wird der Gerätename angezeigt, z. B.: T86-1xxxxx, und klicken Sie auf Ändern-Schaltfläche [  ], um den Bluetooth-Namen des Geräts zu ändern. Wählen Sie den Gerätenamen mit Bluetooth und den Remote-Gerätenamen von aus Das Telefon wird nach erfolgreicher Verbindung angezeigt.

Zu diesem Zeitpunkt können Sie Handymusik und andere Funktionen abspielen.

Nachdem Sie sich mit Bluetooth verbunden haben, können Sie die Anruffunktion verwenden:

Klicken Sie auf die Schaltfläche Trennen [  ], um die Bluetooth-Verbindung aktiv zu trennen.



## G. Audioausgabe



Audioausgabe

### 1. Lautsprecherausgang

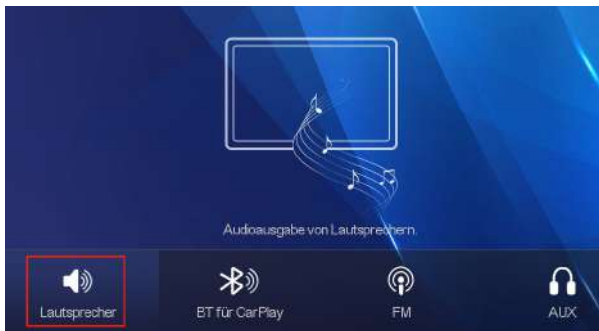

### 2. BT-Ausgang:



### 3. FM-Ausgang:



Klicken Sie wie in der Abbildung gezeigt auf [FM Übertragung] Taste, um die FM-Sendefunktion aufzurufen: es kann den Ton des Gerätes aussenden, ihn mit empfangen das Original-Autoradio, und spielen Sie es über die originale Autohupe, genießen Sie das ursprüngliche Autoniveau. Wenn Sie die FM-Sendeoption einschalten, wird die Der Monitor gibt keinen Ton mehr aus. Bei diesem Zeit, müssen Sie ausschalten die FM-Übertragung oder passen Sie den Ton an den des Autos an eingebaute Stereoanlage, um Ton zu haben.

**(Wenn Sie nicht das Original-Netzkabel verwenden, wird das FM-Sendesignal verursacht zu verschlechtern oder die Funktion kann nicht verwendet werden.)**



1. Wählt das zu sendende Frequenzband aus, z. B. FM 106,0 MHz.
2. Autoradio stellt auch das Akzeptanzband auf FM 106,0 MHz ein.
3. Autoradio kann sich mit dem FM-Sendesignal des oberen Systems verbinden. Nachdem die FM-Startverbindung erfolgreich hergestellt wurde, werden alle Sounds an gesendet Original Autolautsprecher zum Spielen..

(Empfohlenes FM: 100-108MHz)

#### 4. AUX-Ausgang:





## H. Einstellung



Klicken Sie, wie in der Abbildung gezeigt, auf die Schaltfläche [  ] in der unteren linken Ecke, um Rufen Sie die Einstellungsschnittstelle auf

Icon	specification
	Klicken Sie auf [Erinnerungston]. Tippen Sie hier, um den Touch- und Startton ein-/auszuschalten
	Bildspiegelung: Ein/Aus Die Rückfahrkamera unterstützt das horizontale Umklappen des Spiegels
	Optionen: Ein/Aus Sie können die Umkehrlinien einstellen, bitte überprüfen Sie die Anweisungen auf der nächsten Seite
	Optionen: Aus / 10S/30S/1 Minuten Wenn keine Bedienung erfolgt, schaltet sich der Bildschirm nach 10S/30S/1 Minuten aus, bitte drücken Sie die Ein/Aus- Taste, um den Bildschirm einzuschalten
	Hintergrundbild: Ändern Sie das Hintergrundbild der Hauptschnittstelle
	Klicken Sie auf [Nachtmodus]. Schalten Sie den Augenschutzmodus ein/aus und stellen Sie die Helligkeit des Nachtbildschirms ein

	<p>Klicken Sie auf [Fahrposition], um die Einstellung einzugeben: Sie können zwischen linkem und rechtem Ruder wählen. Wählen Sie in der Kontextmenüleiste von Apple CarPlay links das linke Seitenruder und rechts das rechte Seitenruder aus.</p>
	<p>Optionen: Vereinfachtes Chinesisch/Traditionelles Chinesisch / Englisch / Russisch / Spanisch / Französisch / Deutsch / Japanisch / Koreanisch</p>

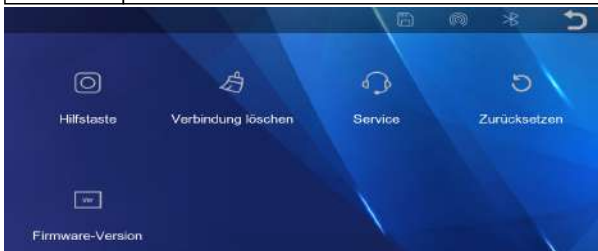

	<p>Klicken Sie auf [Hilfstaste], um die Umkehreinstellungen einzugeben. Auf dem Bildschirm werden der Status und der Rückfahrlinienrahmen beim Rückwärtsfahren ein-/ausgeschaltet. Sie können die Rückfahrlinienrahmen entsprechend der Größe Ihres Autos anpassen.</p>
	<p>Klicken Sie auf [Verbindungen löschen], um die mit dem Mobiltelefon verbundenen WLAN- und Bluetooth-Datensätze zu löschen.</p>
	<p>Klicken Sie auf [Service] bitte nutzen Sie Ihr Mobiltelefon, um den QR-Code zu scannen und Online-Dienste zu erhalten.</p>
	<p>Werksreset: Stellt die Werkseinstellungen wieder her</p>
	<p>Firmware-Version: Bestätigen Sie die System-Firmware-Version</p>

# I. Parklinien Kalibrierung

Methode: Verbinden Sie das Original-Datenkabel des Mobiltelefons einseitig mit dem USB-Anschluss des Autoladenetzteils.

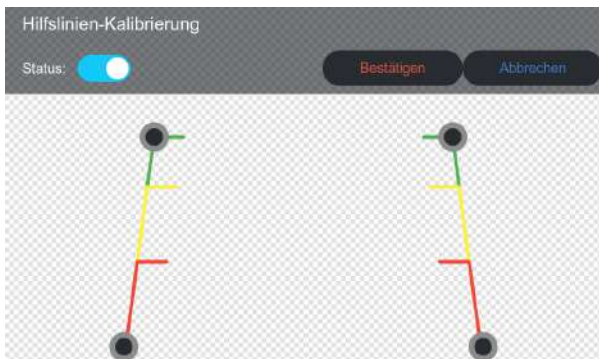

Parken Sie das Auto in der Mitte des Parkplatzes.



Halten Sie das X gedrückt, um die Position und den Winkel der Rückfahrlinie einzustellen. Bitte stellen Sie sicher, dass die Parklinie horizontal zum Boden verläuft.



Klicken Sie auf [Bestätigen], um die Kalibrierung zu speichern.

## FAQ:

1. Da der Ausgangsstrom beim Starten des Autos instabil ist, drehen Sie bitte Schalten Sie das FM aus, bevor Sie das Auto anhalten, sonst macht das FM Geräusche, wenn Sie starten das Auto wieder.
2. Wenn Sie das FM verwenden, um das Carplay zu verbinden, verwenden Sie bitte nicht dasselbe Frequenz wie die Sendung, andernfalls wird das Carplay Frequenz sein ruckeln und kein ton. Sie können das AUX-Kabel zum Anschließen verwenden carplay, das dieses Problem effektiv lösen kann.
3. Bei einigen Android-Telefonen können aufgrund unterschiedlicher Marken und Systemversionen Probleme mit der drahtlosen Verbindung auftreten. Daher bieten wir eine kabelgebundene Verbindung für Android-Telefone an.  
Methode: Das Autoladekabel verfügt über einen USB-Anschluss. Sie können Ihr Android-Telefon über Ihr Original-Telefondatenkabel mit dem USB-Anschluss verbinden.
4. Warten Sie nach der Verbindung mit Carplay/Android Auto auf 10-20 Sekunden, und dann verbindet das System Ihr Telefon automatisch.
5. Bevor Sie erneut eine Verbindung herstellen, schalten Sie bitte Bluetooth und WIFI, das System, ein stellt automatisch eine Verbindung zu Ihrem Mobiltelefon her.
6. Bitte gemäß unserem Vorschlag den Stromkreis anschließen und vermeiden Störungen beim Starten der Maschine.

Español





Español

Si tiene alguna pregunta sobre nuestra cámara de tablero, contáctenos

**[DC@yoomail.com](mailto:DC@yoomail.com)**

Podemos proporcionarle una solución que pueda aceptar.

1. Resumen del Producto -----	79
2. Lista de Composición de Productos -----	80
3. Descripción del Producto -----	81
4. Instrucciones de Cableado -----	82
5. Instalación de la cámara de ----- marcha atrás (opcional)	83
6. Especificar Interfaz -----	84
A. Apple CarPlay -----	85
B. Android Auto -----	87
C. AirPlay -----	89
D. Android Cast -----	90
E. Música Bluetooth -----	91
F. Bluetooth -----	92
G. Salida de Audio -----	93
H. Configuración -----	96
I. Calibración de la línea de estacionamiento -----	98
PREGUNTAS MÁS FRECUENTES: -----	99

# 1. Resumen del Producto

Los Smart Screen Players transmiten a través de Bluetooth y WiFi.

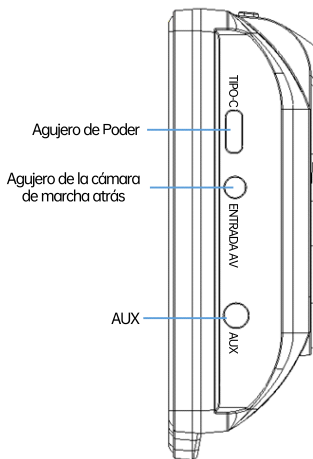

## 2. Lista de Composición de Productos



El anfitrión

Pantalla FHD / control táctil / Bluetooth / Wi-Fi / Transmisor FM / Fuente de alimentación de interfaz tipo C



El cable de alimentación

Cable de alimentación tipo C / corriente 5V / 3A / cable integrado / encendedor para tomar energía



Cables Auxiliares

Cable de audio de 3,5 cabezales Conecte la interfaz auxiliar en el automóvil para transmitir el sonido del equipo al audio del automóvil



Base de Monitor

Para apoyar la pantalla y fijarla en la consola central



Montaje de Ventosa

Instale en la parte posterior de la pantalla carplay, permita que se adhiera al parabrisas del vehículo

### 3. Descripción del Producto

Proyecto	Introducción a la función	Indicadores de desempeño
Sistema	Idioma	Chino simplificado / Chino tradicional / Inglés / Ruso / Español / Francés / Alemán / Japonés / Coreano
	Fondo de pantalla	Cambiar el fondo de pantalla
	Restablecimiento de fábrica	Función de restaurar a la configuración de fábrica
	Versión de firmware	Versión de software nativo
Inteligente + conectado	Wi-Fi	Admite Apple CarPlay y Android Auto
	Bluetooth	Conecte su teléfono para realizar la función Carplay
Transmisión FM	FM	Soporte de transmisión FM, conectado a la radio del coche
Parte de audio	Control de voz	Admite la función de operación de voz
Parte de poder	La entrada de energía	El terminal de entrada de carga del vehículo admite un voltaje amplio de 12-24 V y salidas de 5 V/3 A
Otro	Temperatura de trabajo	-4 ~150 °F
	La forma de enfriamiento	Refrigeración pasiva

## 4. Instrucciones de Cableado

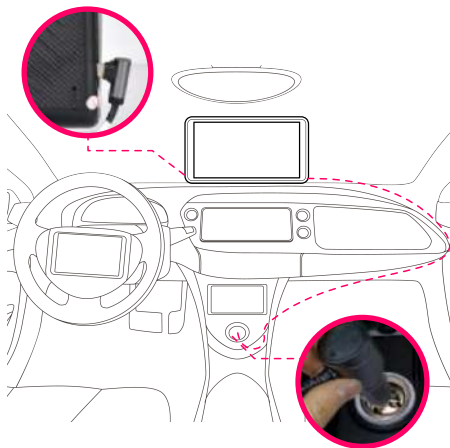

Los detalles son los siguientes:

Puerto	Instrucciones
Interfaz tipo C	Interfaz de fuente de alimentación del monitor
Cargador de Cigarrillos	1. Nota: El producto tiene un cargador de cigarrillos FM incorporado en el paquete. Por favor, tiene que utilizar el cargador de coche original. Otro cargador de automóvil puede dañar el carplay debido a un voltaje y calor insuficientes, la función del transmisor FM no puede funcionar normalmente si no es el cargador de automóvil original.

## 5. Instalación de la cámara de marcha atrás (opcional)

Confirme la posición para instalar la cámara de marcha atrás, marque el orificio del tornillo en la placa de matrícula antes de la instalación.

Asegúrese de perforar un orificio del tamaño adecuado para el tornillo.

El cable rojo de la cámara de marcha atrás debe conectarse al cable positivo de la luz de marcha atrás.





## 6. Especificar Interfaz

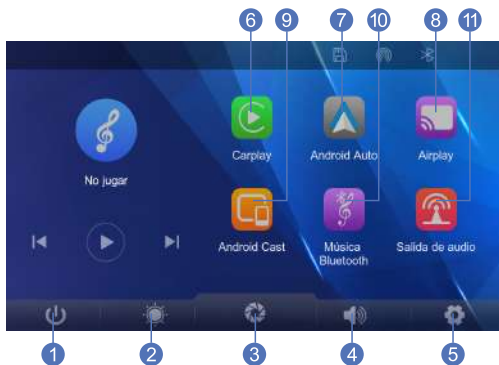

- 1. Pantalla ON/OFF:** enciende y apaga la pantalla
- 2. Botón Brillo:** haga clic para ajustar el brillo de la pantalla.
- 3. DVR:** haga clic para ingresar a la interfaz de grabación de video.
- 4. Botón de volumen:** haga clic para ajustar el volumen.
- 5. Configuración:** Haga clic para ingresar a la interfaz de configuración del sistema para configurar la pantalla.
- 6. Apple CarPlay:** haga clic para conectarse al Apple Carplay del iPhone
- 7. Android Auto:** haga clic para conectarse al Android Auto del teléfono móvil Android
- 8. Apple AirPlay:** comparte videos, fotos, música y más desde el iPhone a la pantalla
- 9. Android Cast:** comparta videos, fotos, música y más desde teléfonos Android a la pantalla
- 10. Música Bluetooth:** Utilice su teléfono móvil para conectarse a un dispositivo Bluetooth y reproducir música.
- 11. Salida de audio:** haga clic para seleccionar el modo de reproducción de sonido.

## A. Apple CarPlay



Como se muestra en la figura, haga clic en el botón [Apple CarPlay] para ingresar a Apple CarPlay. Encienda el Wi-Fi y Bluetooth del teléfono móvil primero, luego, como se muestra en la figura a continuación, seleccione la opción [Apple CarPlay], haga clic en la opción [Administrar BT] de la interfaz, conecte Bluetooth con el teléfono, puede abrir la aplicación. Cuando la máquina esté encendida, intentará conectarse automáticamente al último teléfono conectado.

**(Apague el Wi-Fi de su teléfono para desconectarlo, la opción Apple CarPlay solo es compatible con teléfonos iPhone, teléfono Android, seleccione la opción [Android auto])**

**(El método de conexión específico es el siguiente)**

### 1. Abrir Carplay



## 2. Encienda el interruptor de Bluetooth y WiFi en el teléfono móvil



## 3. Encuentre el nombre del dispositivo t86 xxxxx en otros dispositivos, use CarPlay

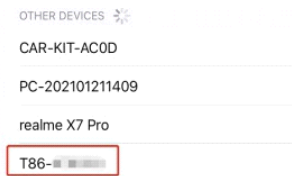

## 4. Conexión exitosa

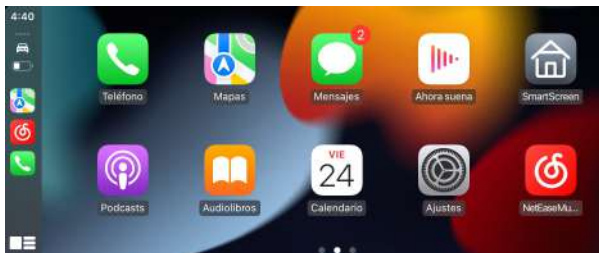

Consejos: Oye, Siri, enciende tu teléfono, escucha música, haz llamadas telefónicas, navega, consulta el clima, etc. a través de tu dispositivo

## B. Android Auto



Como se muestra en la figura, haga clic en el botón [Android Auto] para ingresar a Android auto. Encienda el Wi-Fi y Bluetooth del teléfono móvil primero, luego, como se muestra en la figura a continuación, seleccione la opción [Android auto], haga clic en la opción [BT Manage] de la interfaz, conecte Bluetooth con el teléfono, puede abrir la aplicación. Cuando la máquina esté encendida, intentará conectarse automáticamente al último teléfono conectado.

**(Apague el Wi-Fi de su teléfono para desconectarse)**

### 1. Abrir Android Auto

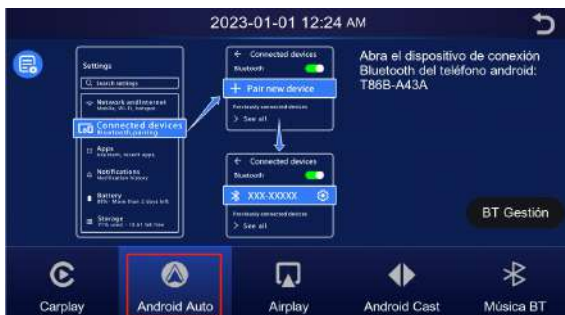

2. Para usar Android Auto, el teléfono Google Pixels necesita Android 8.0 o superior.

3. Para teléfonos Android de otras marcas, el sistema debe ser Android 11 o superior.

4.Después de conectar el dispositivo Bluetooth, se conectará automáticamente al WiFi, no vuelva a conectarse manualmente al dispositivo WiFi.

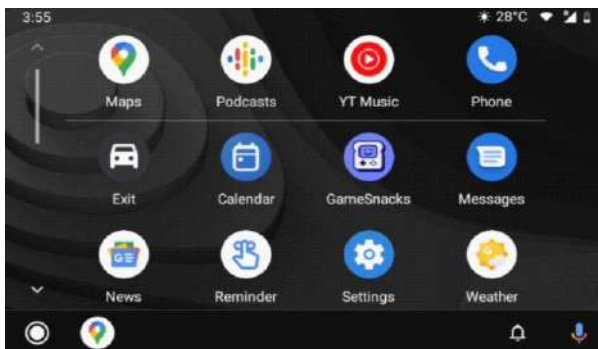

**Nota:** Algunos teléfonos Android pueden tener problemas de conexión inalámbrica debido a las diferentes marcas y versiones del sistema. Así que ofrecemos conexión por cable para teléfono Android

**Método:** hay un puerto USB en el cable del cargador del automóvil, puede conectar su teléfono Android al puerto USB con el cable de datos original de su teléfono

## C. AirPlay



Airplay admite la transferencia de video, audio e imágenes desde iPhone a carplay mediante la función WiFi.

Pasos:

1. Requiere que tu iPhone se conecte al WiFi de Carplay
2. Seleccione SmartScreen en Screen Mirroring en el Centro de control de iPhone

**Note:** solo admite teléfonos iPhone

## D.Android Cast



Puede realizar la proyección en espejo del teléfono móvil y de la máquina del automóvil.

Debe escanear el código con su teléfono móvil para descargar, instalar y ejecutar la aplicación "TcLink".



**Nota: Solo admite teléfonos Android (el teléfono móvil debe admitir la función de conexión directa WIFI)**

## E.Música Bluetooth

Puede encontrar Música Bluetooth haciendo clic en el botón Apple CarPlay o Android Auto. Encienda primero el Bluetooth del teléfono móvil seleccione la opción [Bluetooth Music]. Haga clic en la opción [Administrar BT] en la interfaz para conectar Bluetooth al teléfono móvil y comenzar a reproducir música.

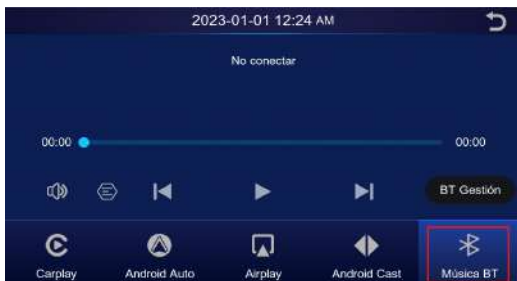

Los botones corresponden a Último, Reproducir/Pausar y Siguiente, respectivamente.

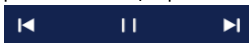

Haga clic en el botón Letras[  ] para mostrar las letras.

**(Algunas aplicaciones de reproductor de música móvil no admiten la visualización de letras)**



## F. Bluetooth



Como se muestra en la figura anterior, haga clic en el botón Bluetooth [  ] para encender el dispositivo después de ingresar a la interfaz Bluetooth.

La página mostrará el nombre del dispositivo, como: T86-1xxxxx, y haga clic en el botón Modificar [  ] para modificar el nombre de Bluetooth del dispositivo. Seleccione el nombre del dispositivo con Bluetooth y el nombre del dispositivo remoto del teléfono aparecerá después de conectarse correctamente.

En este momento, puede reproducir música del teléfono móvil y otras funciones. Después de conectarse a Bluetooth, puede usar la función de llamada:

Haga clic en el botón Desconectar [  ] para desconectar activamente el Bluetooth.

## G.Salida de Audio



Salida de audio

1.Salida de los altavoces



2.BT output:



### 3.Salida FM



Como se muestra en la figura, haga clic en el botón [Transmisión de FM] para ingresar a la función de transmisión de FM: puede emitir el sonido del equipo, recibirlo con la radio original del automóvil y reproducirlo a través de la bocina del automóvil original, disfrutando del automóvil original. nivel. Cuando activa la opción de transmisión de FM, el monitor ya no emitirá ningún sonido. En este momento, debe apagar la transmisión FM o hacer coincidir el sonido con el estéreo incorporado del automóvil para tener sonido.

**(Si no se utiliza el cable de alimentación original, la señal de transmisión de FM se deteriorará o no se podrá utilizar la función).**



1. Selecciona la banda de frecuencia a emitir, por ejemplo, la FM 106.0 MHz.
2. La radio del automóvil también ajusta la banda de aceptación a FM 106.0 MHz.
2. Car radio also adjusts the acceptance band to FM 106.0 MHz.
3. La radio del coche se puede conectar a la señal de transmisión FM del sistema superior. Después de que la conexión de lanzamiento de FM sea exitosa, todos los sonidos se enviarán al altavoz original del automóvil para reproducirlos.

**(FM recomendada: 100-108 MHz).**







#### 4.Salida AUX:





## H.Configuración





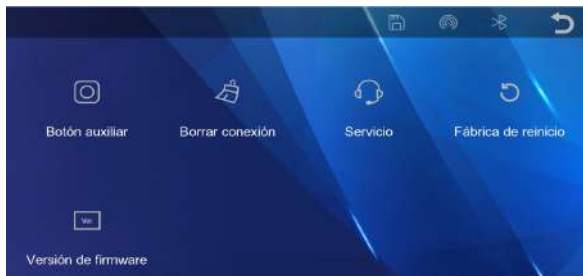

Como se muestra en la figura, haga clic en el botón [  ] en la esquina inferior izquierda para ingresar a la interfaz de configuración.

Icono	Especificación
	Haga clic en [Tono de recordatorio] Toque para apagar/encender el toque y el sonido de arranque
	espejo de imagen:encendido/apagado La cámara trasera admite volteo del espejo horizontal
	Opciones: Encendido/Apagado Puede ajustar las líneas de inversión, consulte los detalles de las instrucciones en la página siguiente
	Opciones: Apagado /10S/30S/1 min La pantalla se apagará después de 10S/30S/1 min si no se realiza ninguna operación. presione el botón de encendido para encender la pantalla
	Fondo de pantalla: cambie el fondo de pantalla de la interfaz principal
	Haga clic en [modo nocturno] Activar/desactivar el modo de protección ocular y configurar el brillo nocturno de la pantalla

	<p>Haga clic en [Posición de conducción] para introducir la configuración: Puede seleccionar timón izquierdo o timón derecho. En la barra de menú de acceso directo de Apple CarPlay, seleccione el timón izquierdo a la izquierda y seleccione el timón derecho a la derecha.</p>
	<p>Opciones: chino simplificado/chino tradicional/inglés / Ruso / Español / Francés / Alemán / Japonés / Coreano</p>



	<p>Haga clic en [Boton auxiliar] para activar/desactivar el botón flotante en la pantalla.</p>
	<p>Haga clic en [Borrar conexiones] para borrar los registros de Wi-Fi y Bluetooth conectados al teléfono móvil.</p>
	<p>Haga clic en [Servicio], por favor, use su teléfono móvil para escanear el código QR y obtener servicios en línea.</p>
	<p>Restablecimiento de fábrica: restaurar la configuración de fábrica</p>
	<p>Versión de firmware: confirme la versión de firmware del sistema</p>

# I. Calibración de la línea de estacionamiento

Haga clic en [Calibración] para ingresar la configuración:

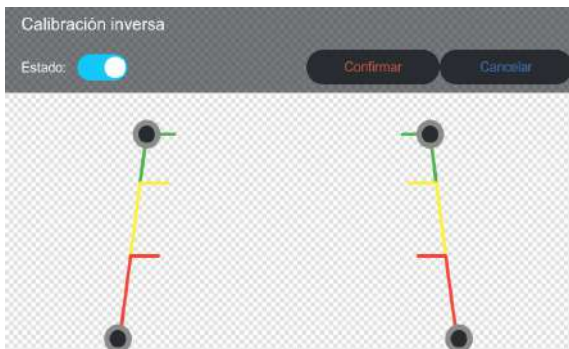

Estacione el automóvil en el medio del espacio de estacionamiento.



Mantenga presionada la X para ajustar la posición y el ángulo de la línea de marcha atrás, asegúrese de que la línea de estacionamiento esté horizontal con respecto al suelo.



Haga clic en [confirmar] para guardar la calibración.

## **PREGUNTAS MÁS FRECUENTES:**

1. Debido a que la corriente de salida es inestable cuando el automóvil arranca, apague la FM antes de detener el automóvil; de lo contrario, la FM hará ruido cuando vuelva a encender el automóvil.

2. Cuando use FM para conectar el carplay, no use la misma frecuencia que la transmisión, de lo contrario, el carplay tendrá un salto de frecuencia y no tendrá sonido. Puedes usar el cable AUX para conectar el carplay, lo que puede resolver este problema de manera efectiva.

3. Algunos teléfonos Android pueden tener problemas de conexión inalámbrica debido a las diferentes marcas y versiones del sistema. Por eso ofrecemos conexión por cable para teléfonos Android.

Método: Hay un puerto USB en el cable del cargador del automóvil, puede conectar su teléfono Android al puerto USB con el cable de datos original de su teléfono.

4. Antes de volver a conectarse, encienda Bluetooth y WIFI, el sistema conectará automáticamente su teléfono móvil.

5. De acuerdo con nuestra sugerencia de conectar el circuito de alimentación y evitar interferencias cuando se enciende la máquina.





Français



Français

Si vous avez des questions sur notre caméra de tableau de bord, veuillez nous contacter

**[DC@yoomail.com](mailto:DC@yoomail.com)**

nous pouvons fournir une solution que vous pouvez accepter.

1. Présentation du produit -----	105
2. Liste de composition du produit -----	106
3. Description du produit -----	107
4. Instructions de câblage -----	108
5. Installation de la caméra de recul -----	110
6. Interface Spécifier -----	111
A. Apple Car Play -----	112
B. Android Auto -----	114
C. AirPlay -----	116
D. Android Cast -----	117
E. Musique Bluetooth -----	118
F. Bluetooth -----	119
G. Sortie audio -----	121
H. Réglage -----	124
I. Étalonnage de la ligne de stationnement -----	126
FAQ -----	127

# 1.Présentation du produit

Les lecteurs d'écran intelligents transmis via Bluetooth et WiFi.

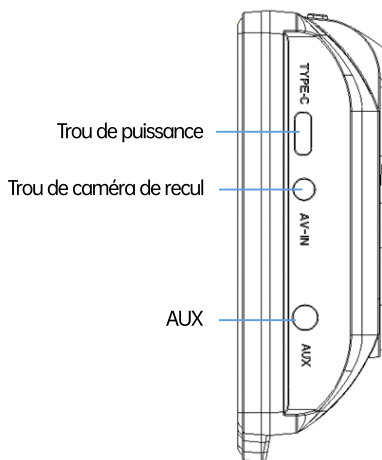

## 2. Liste de composition du produit



The host

Affichage FHD/contrôle tactile/Bluetooth/Wi-Fi/  
transmission FM/alimentation d'interface de  
Type C



Le cordon  
d'alimentation

Cordon d'alimentation de type C/courant 5V/  
3A/câble intégré/allume-cigare pour prendre  
l'alimentation



Câble auxiliaire

Câble audio 3,5 têtes Connectez l'interface  
auxiliaire sur la voiture pour transmettre le son  
de l'équipement à l'audio de la voiture



Socle de moniteur

Pour soutenir l'écran et le fixer sur la console  
centrale



Support à ventouse

Installez-le à l'arrière de l'écran carplay, laissez-le  
se fixer au pare-brise du véhicule

### 3.Description du produit

Projet	Présentation de la fonction	Des indicateurs de performance
Système Intelligent + connecté Transmission Fm Partie audio Partie puissance	Langue	Chinois simplifié / Chinois traditionnel / Anglais / Russe / Espagnol / Français / Allemand / Japonais / Coréen
	Fond d'écran	Changer le fond d'écran
	Retour aux paramètres d'usine	Fonction de restauration des paramètres d'usine
	Version du firmware	Version logicielle native
Autre Projet	Wifi	Prend en charge Apple CarPlay et Android Auto
	Bluetooth	Connectez votre téléphone pour réaliser la fonction Carplay
Système	MF	Prise en charge de la transmission FM, connectée à l'autoradio
Intelligent + connecté	Commande vocale	Prend en charge la fonction d'opération vocale
Transmission Fm	L'entrée de puissance	La borne d'entrée de charge du véhicule prend en charge une tension large de 12 à 24 V et produit 5V/3A.



Partie audio	Température de fonctionnement	-4 ~ 150 °F
	La méthode de refroidissement	Refroidissement passif

## 4. Wiring instructions

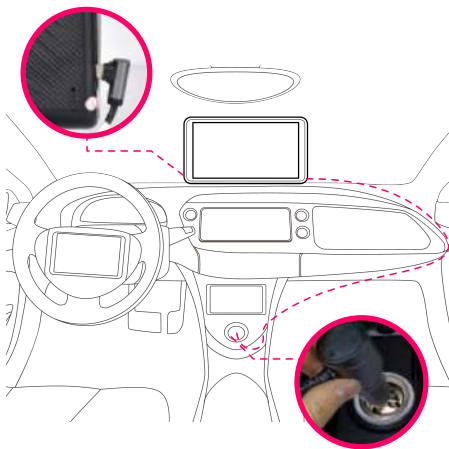

Les détails sont les suivants:

<b>Port</b>	<b>Instructions</b>
Interface de type C	Interface d'alimentation du moniteur
Chargeur de cigarettes	1. Remarque : le produit dispose d'un chargeur de cigarette FM intégré dans l'emballage. Veuillez utiliser le chargeur de voiture d'origine. Un autre chargeur de voiture peut endommager le carplay en raison d'une tension et d'une chaleur insuffisantes, la fonction d'émetteur FM ne peut pas fonctionner normalement si ce n'est pas le chargeur de voiture d'origine.

## 5. Installation de la caméra de recul (facultatif)

Confirmez la position d'installation de la caméra de recul, marquez le trou de vis sur la plaque d'immatriculation avant l'installation. Veuillez vous assurer de percer un trou de taille appropriée pour la vis. Le fil rouge de la caméra de recul doit être connecté au fil positif du feu de recul.

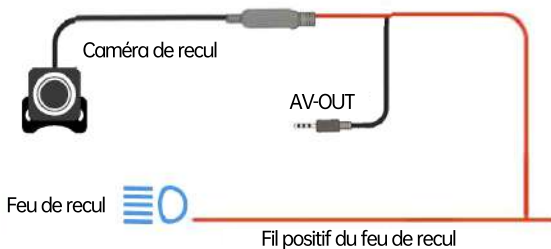

## 6. Interface Spécifier



- 1. Écran ON/OFF :** Allumer et éteindre l'écran
- 2. Bouton Luminosité:** Cliquez pour régler la luminosité de l'écran
- 3. Enregistreur vidéo numérique:** Cliquez pour accéder à l'interface d'enregistrement vidéo
- 4. Bouton Volume:** Cliquez pour régler le volume
- 5. Paramètres:** cliquez pour accéder à l'interface de configuration du système pour définir l'écran.
- 6. Apple CarPlay:** cliquez pour vous connecter à Apple Carplay de l'iPhone
- 7. Android Auto:** cliquez pour vous connecter à Android Auto du téléphone mobile Android.
- 8. Apple AirPlay:** partagez des vidéos, des photos, de la musique et bien plus encore depuis l'iPhone vers l'écran
- 9. Android Cast:** partagez des vidéos, des photos, de la musique et bien plus encore depuis un téléphone Android vers l'écran
- 10. Musique Bluetooth :** utilisez votre téléphone mobile pour vous connecter à un appareil Bluetooth et écouter de la musique.
- 11. Sortie audio:** cliquez pour sélectionner le mode de lecture du son

# A.Apple Car Play



Comme indiqué sur la figure, cliquez sur le bouton [Apple CarPlay] pour accéder à Apple CarPlay. Activez d'abord le Wi-Fi et le Bluetooth du téléphone mobile, puis comme indiqué dans la figure ci-dessous, sélectionnez l'option [Apple CarPlay], cliquez sur l'option [BT Manage] de l'interface, connectez Bluetooth au téléphone, vous pouvez ouvrir L'application. Lorsque la machine est allumée, elle essaie de se connecter automatiquement au dernier téléphone connecté.

**(Éteignez le Wi-Fi de votre téléphone pour vous déconnecter, l'option Apple CarPlay ne prend en charge que les téléphones iPhone, téléphone Android, veuillez sélectionner l'option [Android auto])**

**(La méthode de connexion spécifique est la suivante)**

## 1.Ouvrez Carplay



## 2. Allumez le commutateur Bluetooth et WiFi sur le téléphone mobile

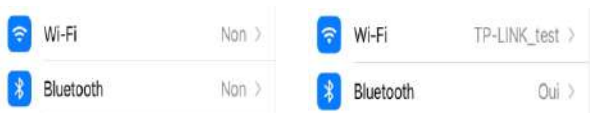

## 3. Trouvez le nom de l'appareil t86 xxxxx dans d'autres appareils, utilisez CarPlay

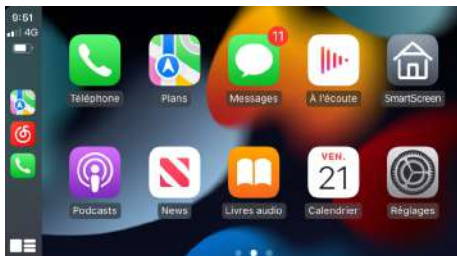

Conseils : Hé, Siri, réveillez votre téléphone, écoutez de la musique, passez des appels téléphoniques, naviguez, consultez la météo, etc. via votre appareil

## B.Android Auto

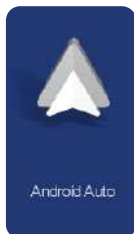

Comme indiqué sur la figure, cliquez sur le bouton [Android Auto] pour accéder à Android auto. Activez d'abord le Wi-Fi et le Bluetooth du téléphone mobile, puis comme indiqué dans la figure ci-dessous, sélectionnez l'option [Android auto], cliquez sur l'option [BT Manage] de l'interface, connectez Bluetooth au téléphone, vous pouvez ouvrir L'application. Lorsque la machine est allumée, elle essaie de se connecter automatiquement au dernier téléphone connecté.

**(Désactivez le Wi-Fi de votre téléphone pour vous déconnecter)**

1.Ouvrez Android Auto



2.Pour utiliser Android Auto, le téléphone Google Pixels doit disposer d'Android 8.0 ou d'une version ultérieure.

3.Pour les téléphones Android d'autres marques, le système doit être Android 11 ou supérieur.

4. Après avoir connecté l'appareil Bluetooth, il se connectera automatiquement au WiFi, veuillez ne pas vous reconnecter manuellement à l'appareil WiFi.

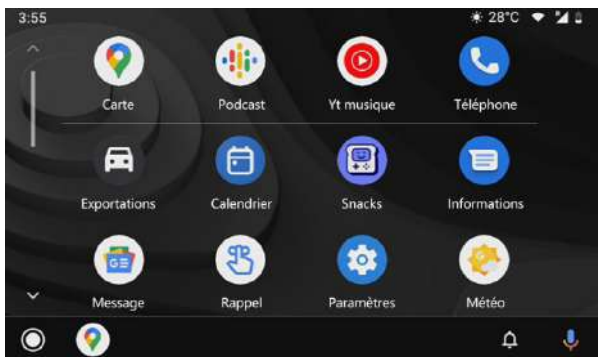

**Remarque :** Certains téléphones Android peuvent rencontrer des problèmes de connexion sans fil en raison de marques et de versions de système différentes. Nous proposons donc une connexion filaire pour téléphone Android

**Méthode :** il y a un port USB sur le câble du chargeur de voiture, vous pouvez connecter votre téléphone Android au port USB par votre câble de données de téléphone d'origine.



## C.AirPlay



Airplay prend en charge le transfert de vidéos, d'audio et d'images de l'iPhone vers la voiture via la fonction WiFi.

Pas:

1. Exigez que votre iPhone se connecte au WiFi de Carplay
- 2.Sélectionnez SmartScreen dans Screen Mirroring dans le centre de contrôle de l'iPhone

**Remarque :** prend uniquement en charge les téléphones iPhone

## D.Android Cast



Il peut réaliser la projection miroir du téléphone portable et de la machine automobile.

Vous devez scanner le code avec votre téléphone mobile pour télécharger, installer et exécuter l'application « TcLink ».



**Remarque :** prend uniquement en charge les téléphones Android (le téléphone mobile doit prendre en charge la fonction de connexion directe WIFI)

## E.Musique Bluetooth

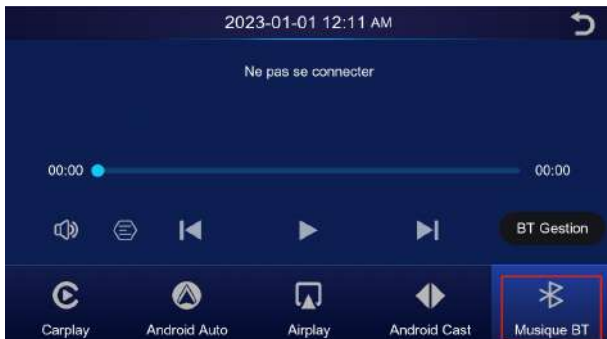

Vous pouvez trouver Bluetooth Music en cliquant sur le bouton Apple CarPlay ou Android Auto. Activez d'abord le Bluetooth du téléphone mobile, puis sélectionnez l'option [Musique Bluetooth]. Cliquez sur l'option [BT Manage] sur l'interface pour connecter Bluetooth au téléphone mobile et commencer à jouer de la musique.

Les boutons correspondent respectivement à Last, Play / Pause et Next.





Cliquez sur le bouton Paroles [  ] pour afficher les paroles.

**(Certaines applications de lecteur de musique mobile ne prennent pas en charge l'affichage des paroles)**

## F. Bluetooth



Comme indiqué dans la figure ci-dessus, cliquez sur le bouton Bluetooth [  ] pour allumer l'appareil après avoir accédé à l'interface Bluetooth.

La page affichera le nom de l'appareil, tel que : T86-1xxxxx, et cliquez sur le bouton Modifier [  ] pour modifier le nom Bluetooth de l'appareil. Sélectionnez le nom de l'appareil avec Bluetooth, et le nom de l'appareil distant du téléphone apparaîtra après une connexion réussie.

À ce stade, vous pouvez écouter de la musique sur votre téléphone portable et d'autres fonctions. Après vous être connecté au Bluetooth, vous pouvez utiliser la fonction d'appel :

Cliquez sur le bouton Déconnecter [  ] pour déconnecter activement le Bluetooth.

## G.Sortie audio



Sortie audio

1.Sortie haut-parleur



2. Sortie Bluetooth



### 3.Sortie FM



Comme indiqué sur la figure, cliquez sur le bouton [Transmission FM] pour accéder à la fonction de transmission FM : il peut émettre le son de l'équipement, le recevoir avec l'autoradio d'origine et le jouer via le klaxon de voiture d'origine, en profitant de la voiture d'origine. Lorsque vous activez l'option de transmission FM, le moniteur n'émet plus de son. À ce stade, vous devez désactiver la transmission FM ou faire correspondre le son à la chaîne stéréo intégrée de la voiture pour avoir du son.

**(Ne pas utiliser le cordon d'alimentation d'origine entraînera la détérioration du signal de transmission FM ou la fonction ne**

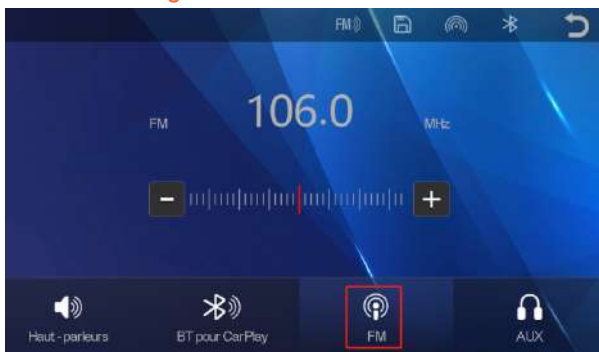

- 1.Sélectionne la bande de fréquence à émettre, par exemple, le FM 106,0 MHz.
2. L'autoradio ajuste également la bande d'acceptation à FM 106,0 MHz.
3. L'autoradio peut se connecter au signal de transmission FM du système supérieur. Une fois la connexion de lancement FM réussie, tous les sons seront envoyés au haut-parleur d'origine de la voiture pour être lus.

(FM recommandé : 100-108 MHz)

1.Sortie AUX :







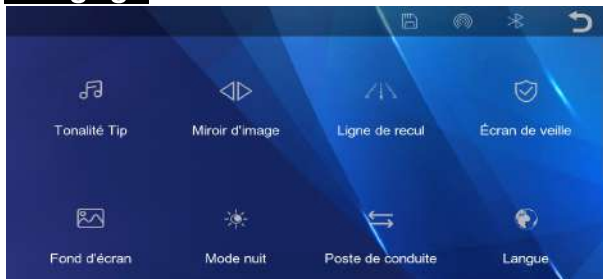



## H.Réglage





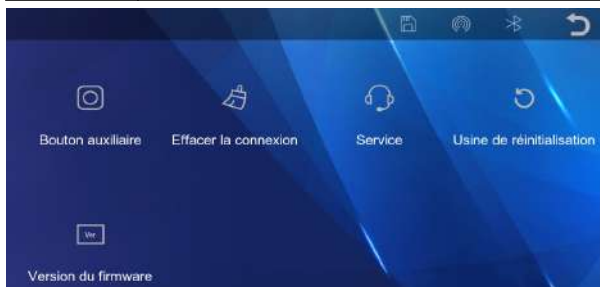

Comme indiqué sur la figure, cliquez sur le bouton [  ] dans le coin inférieur gauche pour accéder à l'interface de réglage

Icône	spécification
	Cliquez sur [Tonalité Tip] Appuyez pour désactiver/activer le son tactile et de démarrage
	Miroir d'image : Marche/Arrêt La caméra arrière prend en charge le retournement horizontal du miroir
	Options : Marche/Arrêt Vous pouvez régler les lignes d'inversion, veuillez vérifier les détails des instructions à la page suivante
	Options : Arrêt / 10S/30S/1 min L'écran s'éteint après 10S/30S/1 min si aucune opération, appuyez sur le bouton d'alimentation pour allumer l'écran
	Fond d'écran : modifier le fond d'écran de l'interface principale
	Cliquez sur [Mode nuit] Activer/désactiver le mode de protection des yeux et régler la luminosité de l'écran de nuit

	<p>Cliquez sur [Position de conduite] pour entrer le paramètre: Vous pouvez sélectionner le gouvernail gauche ou le gouvernail droit. Dans la barre de menus de raccourcis d'Apple CarPlay, sélectionnez le gouvernail gauche à gauche et sélectionnez le gouvernail droit à droite.</p>
	<p>Options : Chinois simplifié/Chinois traditionnel/Anglais / Russe / Espagnol / Français / Allemand / Japonais / Coréen</p>



	<p>Cliquez sur [Bouton auxiliaire] pour activer/désactiver le bouton flottant sur l'écran.</p>
	<p>Cliquez sur [Effacer les connexions] pour effacer les enregistrements Wi-Fi et Bluetooth connectés au téléphone mobile.</p>
	<p>Cliquez sur [Service] s'il vous plaît utilisez votre téléphone portable pour scanner le code QR afin d'obtenir des services en ligne.</p>
	<p>Réinitialisation d'usine : restaurer les paramètres d'usine</p>
	<p>Version du micrologiciel : confirmer la version du micrologiciel du système</p>

## I.Étalonnage de la ligne de stationnement

Cliquez sur [Calibrage] pour entrer les paramètres :

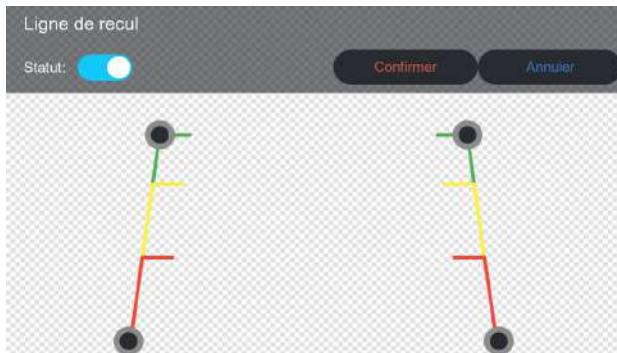

Garez la voiture au milieu de la place de parking.



Maintenez le X pour régler la position et l'angle de la ligne de recul, assurez-vous que la ligne de stationnement est horizontale par rapport au sol.



Cliquez sur [ confirmer ] pour enregistrer le calibrage.

## FAQ:

1. Parce que le courant de sortie est instable au démarrage de la voiture, veuillez éteindre le FM avant d'arrêter la voiture, sinon le FM fera du bruit lorsque vous redémarrerez la voiture.
2. Lorsque vous utilisez le FM pour connecter le carplay, veuillez ne pas utiliser la même fréquence que la diffusion, sinon le carplay sera en fréquence et sans son. vous pouvez utiliser le câble AUX pour connecter le carplay, ce qui peut résoudre efficacement ce problème.
3. Certains téléphones Android peuvent avoir des problèmes de connexion sans fil en raison de différentes marques et versions de système. Nous proposons donc une connexion filaire pour téléphone Android.  
Méthode : il y a un port USB sur le câble du chargeur de voiture, vous pouvez connecter votre téléphone Android au port USB par votre câble de données de téléphone d'origine.
4. Avant de vous reconnecter, veuillez activer Bluetooth et WIFI, le système connectera automatiquement votre téléphone mobile.
5. Veuillez selon nos suggestions pour connecter le circuit d'alimentation et éviter les interférences lorsque la machine est démarrée.



italiano



italiano

Se hai qualche domanda sulla nostra dash cam, ti  
preghiamo di contattarci

**DC@yoomail.com**

possiamo fornire una soluzione che puoi accettare.



1. Panoramica del prodotto -----	133
2. Elenco della composizione del prodotto -----	134
3. Descrizione del prodotto -----	135
4. Istruzioni per il cablaggio -----	136
5. Installazione della telecamera di retromarcia -----	137
6. Specifica interfaccia -----	138
A.Apple CarPlay -----	139
B.Android Auto -----	141
C.AirPlay -----	143
D.Android Cast -----	144
E.Musica Bluetooth -----	145
F.Bluetooth -----	146
G.Uscita audio -----	147
H.Impostazione -----	150
I .Calibrazione della linea di parcheggio -----	152
FAQ: -----	153

# 1. Panoramica del prodotto

I lettori Smart Screen trasmessi tramite Bluetooth e WiFi.

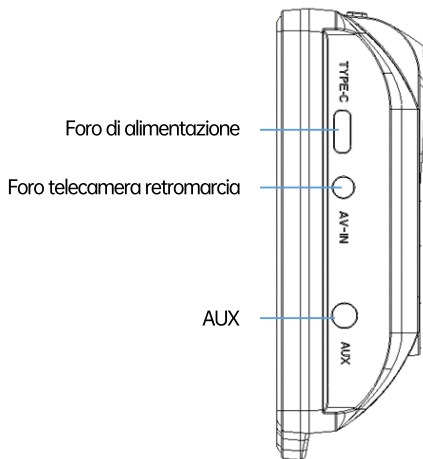

## 2.Elenco della composizione del prodotto



Il padrone di casa

Display FHD / controllo touch / Bluetooth / Wi-Fi / trasmissione FM / alimentazione interfaccia di tipo C



Il cavo di alimentazione

Cavo di alimentazione di tipo C/corrente 5V/3A/cavo integrato/accendisigari per l'alimentazione



Cavo ausiliario

3.5 cavo audio per la testa Collegare l'interfaccia aux sull'auto per trasmettere il suono dell'apparecchiatura all'audio dell'auto



Basamento del monitor

Per sostenere il display e fissarlo sulla consolle centrale



Supporto a ventosa

Installa sul retro dello schermo del carplay, lascia che si attacchi al parabrezza del veicolo

### 3. Descrizione del prodotto

Progetto	Introduzione alla funzione	Indicatori di prestazione
Sistema	Lingua	Cinese semplificato / Cinese tradizionale / Inglese / Russo / Spagnolo / Francese / Tedesco / Giapponese / Coreano
	Sfondo	Cambia lo sfondo dello sfondo
	Ripristino delle impostazioni di fabbrica	Funzione di ripristino alle impostazioni di fabbrica
	Versione del firmware	Versione nativa del software
Intelligente + connesso	Wifi	Supporta Apple CarPlay e Android Auto
	Bluetooth	Collega il tuo telefono per realizzare la funzione Carplay
Trasmissione FM	FM	Supporto di trasmissione FM, collegato all'autoradio
Parte audio	Controllo vocale	Supporta la funzione di comando vocale
Parte di potenza	L'ingresso di potenza	Il terminale di ingresso per la ricarica del veicolo supporta un'ampia tensione di 12-24 V ed emette 5 V/3 A
Altro	Temperatura di lavoro	-4 ~ 150 °F
	Il modo di raffreddamento	Raffreddamento passivo

## 4. Istruzioni di cablaggio

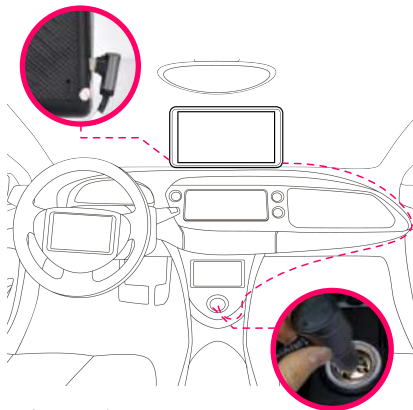

I dettagli sono i seguenti:

Porta	Istruzioni
Interfaccia di tipo C	Monitorare l'interfaccia di alimentazione
Caricatore di sigarette	1. Nota: il prodotto ha un caricatore per sigarette FM integrato nella confezione. Si prega di utilizzare il caricatore per auto originale. Altri caricatori per auto possono danneggiare il carplay a causa della tensione e del calore insufficienti, la funzione del trasmettitore FM non può funzionare normalmente se il caricatore per auto non è originale.

## 5. Installazione della telecamera di retromarcia (opzionale)

Confermare la posizione per installare la telecamera per la retromarcia, contrassegnare il foro per la vite sulla targa prima dell'installazione. Si prega di assicurarsi di praticare un foro di dimensioni adeguate per la vite. Il filo rosso della telecamera di retromarcia deve essere collegato al cavo positivo della luce di retromarcia.



## 6. Specifica interfaccia

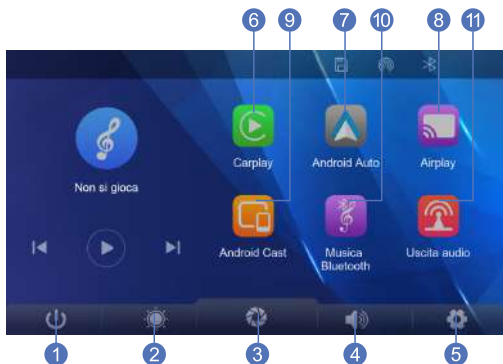

- 1. Schermo ON/OFF :** accende e spegne lo schermo
- 2. Pulsante Luminosità:** fare clic per regolare la luminosità dello schermo
- 3. DVR:** fare clic per accedere all'interfaccia di registrazione video
- 4. Pulsante volume:** fare clic per regolare il volume
- 5. Impostazioni:** fare clic per accedere all'interfaccia di impostazione del sistema per impostare lo schermo
- 6. Apple CarPlay:** fare clic per connettersi all'Apple Carplay dell'iPhone
- 7. Android Auto:** fare clic per connettersi ad Android Auto del telefono cellulare Android
- 8. Apple AirPlay:** condividi video, foto, musica e altro dall'iPhone allo schermo
- 9. Android Cast:** condividi video, foto, musica e altro dai telefoni Android sullo schermo
- 10. Musica Bluetooth:** Utilizza il tuo telefono cellulare per connetterti a un dispositivo Bluetooth e riprodurre musica.
- 11. Uscita audio:** fare clic per selezionare la modalità di riproduzione del suono

# A.Apple CarPlay



Come mostrato nella figura, fare clic sul pulsante [Apple CarPlay] per accedere a Apple CarPlay. Attiva prima il Wi-Fi e il Bluetooth del telefono cellulare, quindi, come mostrato nella figura seguente, seleziona l'opzione [Apple CarPlay], fai clic sull'opzione [BT Manage] dell'interfaccia, connetti il Bluetooth con il telefono, puoi aprire l'applicazione. Quando la macchina è accesa, proverà a connettersi automaticamente all'ultimo telefono connesso..

**(Disattiva il Wi-Fi del telefono per disconnettersi, l'opzione Apple CarPlay supporta solo i telefoni iPhone, il telefono Android seleziona l'opzione [Android auto])**

**(Il metodo di connessione specifico è il seguente)**

## 1.Apri Carplay





## 2. Attivare l'interruttore Bluetooth e WiFi sul telefono cellulare



## 3. Trovare il nome del dispositivo t86 xxxxx in altri dispositivi, utilizzare CarPlay

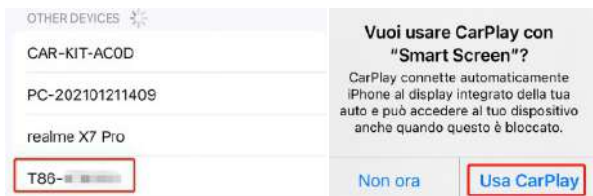

## 4. Connessione riuscita

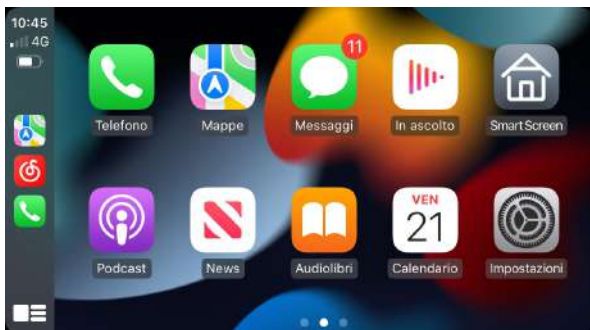

Suggerimenti: Ehi, Siri, riattiva il telefono, ascolta musica, fai telefonate, naviga, controlla il meteo, ecc. attraverso il tuo dispositivo

## B.Android Auto



Come mostrato nella figura, fare clic sul pulsante [Android Auto] per accedere ad Android auto. Attiva prima il Wi-Fi e il Bluetooth del telefono cellulare, quindi, come mostrato nella figura seguente, seleziona l'opzione [Android auto], fai clic sull'opzione [BT Manage] dell'interfaccia, connetti il Bluetooth con il telefono, puoi aprire l'applicazione. Quando la macchina è accesa, proverà a connettersi automaticamente all'ultimo telefono connesso..

**(Disattiva il Wi-Fi del telefono per disconnettersi)**

### 1.Apri Android Auto

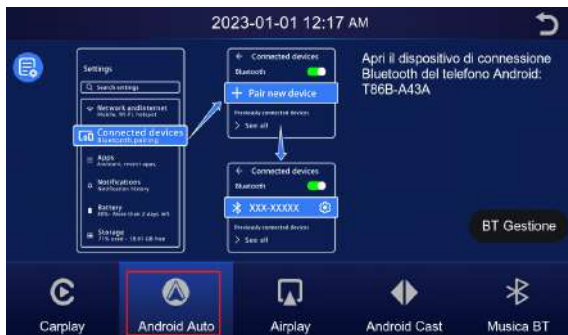

2. Per utilizzare Android Auto, il telefono Google Pixel deve essere Android 8.0 o versioni successive.
3. Per i telefoni Android di altre marche, il sistema deve essere Android 11 o successivo.

4. Dopo aver collegato il dispositivo Bluetooth, si conetterà automaticamente al WiFi, non connettersi nuovamente manualmente al dispositivo WiFi.

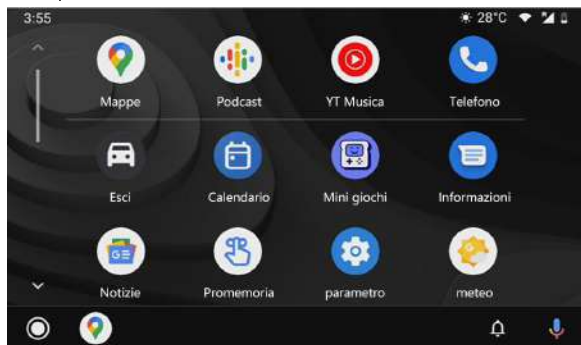

**Nota:** alcuni telefoni Android potrebbero avere problemi di connessione wireless a causa di marche e versioni di sistema diverse. Quindi offriamo una connessione cablata per il telefono Android

**Metodo:** c'è una porta USB sul cavo del caricatore per auto, puoi collegare il tuo telefono Android alla porta USB tramite il cavo dati del telefono originale

## C.AirPlay



Airplay supporta il trasferimento di video, audio e immagini da iPhone a carplay tramite la funzione WiFi.

Passi:

1. Richiedi che il tuo iPhone si connetta al WiFi di Carplay
2. Seleziona SmartScreen in Screen Mirroring nel Centro di controllo dell'iPhone

**Nota:** supporta solo i telefoni iPhone

## D.Android Cast



Può realizzare la proiezione speculare del telefono cellulare e della macchina dell'auto.

È necessario scansionare il codice con il cellulare per scaricare, installare ed eseguire l'applicazione "TcLink".



**Nota: supporta solo telefoni Android (il telefono cellulare deve supportare la funzione di connessione diretta WIFI)**

## E.Musica Bluetooth

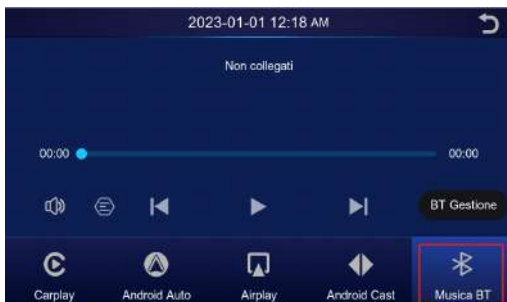

Puoi trovare Bluetooth Music facendo clic sul pulsante Apple CarPlay o Android Auto. Attiva prima il Bluetooth del telefono cellulare e seleziona l'opzione [Musica Bluetooth]. Fare clic sull'opzione [BT Manage] sull'interfaccia per connettere il Bluetooth al telefono cellulare e avviare la riproduzione della musica.





I pulsanti corrispondono rispettivamente a Ultimo, Riproduci/Pausa e Avanti. Fare clic sul pulsante Testi [  ] per visualizzare i testi.

**(Alcune app per lettori musicali mobili non supportano la visualizzazione dei testi)**

## F. Bluetooth



Come mostrato nella figura sopra, fare clic sul pulsante Bluetooth [  ] per accendere il dispositivo dopo essere entrati nell'interfaccia Bluetooth. La pagina visualizzerà il nome del dispositivo, ad esempio: T86-1xxxxx, quindi fare clic sul pulsante Modifica [  ] per modificare il nome Bluetooth del dispositivo. Selezionare il nome del dispositivo con Bluetooth e il nome del dispositivo remoto del telefono verrà visualizzato dopo la connessione riuscita.

In questo momento, puoi riprodurre la musica del telefono cellulare e altre funzioni. Dopo esserti connesso al Bluetooth, puoi utilizzare la funzione di chiamata:

Fare clic sul pulsante Disconnetti [  ] per disconnettere attivamente il Bluetooth.

## G.Uscita audio



Uscita altoparlante altoparlante



## 2.Uscita Bluetooth





### 3.Uscita FM



Come mostrato nella figura, fare clic sul pulsante [FM Transmit] per accedere alla funzione FM Transmit: può emettere il suono dell'apparecchiatura, riceverlo con l'autoradio originale e riprodurlo attraverso il clacson originale dell'auto, godendosi l'auto originale livello. Quando si attiva l'opzione di trasmissione FM, il monitor non emetterà più alcun suono. A questo punto, è necessario disattivare la trasmissione FM o abbinare il suono allo stereo integrato dell'auto per avere un suono.

**(Il mancato utilizzo del cavo di alimentazione originale causerà il deterioramento del segnale di trasmissione FM o la funzione non potrà essere utilizzata.)**



1. Seleziona la banda di frequenza da emettere, ad esempio FM 106.0 MHz.
2. L'autoradio regola anche la banda di accettazione su FM 106,0 MHz.
3. L'autoradio può connettersi al segnale di trasmissione FM del sistema superiore. Dopo che la connessione di avvio FM ha avuto successo, tutti i suoni verranno inviati all'altoparlante dell'auto originale per la riproduzione..

(FM consigliata: 100-108 MHz)

#### 1.Uscita AUX:





## H.Impostazione





Come mostrato nella figura, fare clic sul pulsante [  ] nell'angolo in basso a sinistra per accedere all'interfaccia di impostazione

Icona	specifica
	Fare clic su [Tono di promemoria] Toccare per disattivare/attivare il tocco e il suono di avvio
	Image Mirror: On/Off La fotocamera posteriore supporta il ribaltamento orizzontale dello specchio
	Opzioni: On/Off È possibile regolare le linee di inversione, controllare i dettagli delle istruzioni nella pagina successiva
	Opzioni: Off / 10S/30S/1 minuti Lo schermo si spegne dopo 10S/30S/1 minuti se non viene eseguita alcuna operazione, premere il pulsante di accensione per accendere lo schermo
	Sfondo: cambia lo sfondo dell'interfaccia principale
	Fare clic su [modalità notturna] Attiva/disattiva la modalità di protezione degli occhi e imposta la luminosità dello schermo notturno

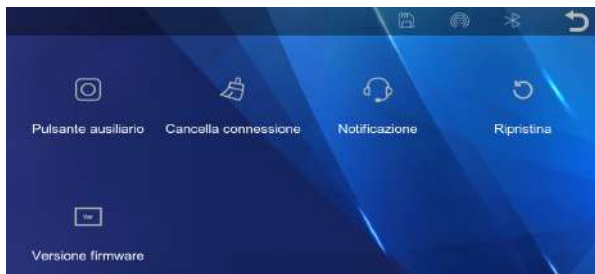
	<p>Fare clic su [Posizione di guida] per accedere all'impostazione: È possibile selezionare il timone sinistro o il timone destro. Nella barra dei menu di scelta rapida di Apple CarPlay, seleziona il timone sinistro a sinistra e seleziona il timone destro a destra.</p>
	<p>Opzioni: cinese semplificato/cinese tradizionale/inglese /Russo/Spagnolo/Francese/Tedesco/Giapponese/Coreano</p>



	<p>Fare clic su [Pulsante ausiliario] per attivare/disattivare il pulsante mobile sullo schermo.</p>
	<p>Fare clic su [Cancella connessione] per cancellare i record Wi-Fi e Bluetooth connessi al telefono cellulare.</p>
	<p>Per accedere al servizio [Service], si prega di utilizzare il proprio telefono cellulare per scannerizzare il codice QR e ottenere i servizi online.</p>
	<p>Factory Reset: Ripristina le impostazioni di fabbrica</p>
	<p>Versione firmware: confermare la versione del firmware del sistema</p>

## I. Calibrazione della linea di parcheggio

Fare clic su [Calibrazione] per accedere alle impostazioni:

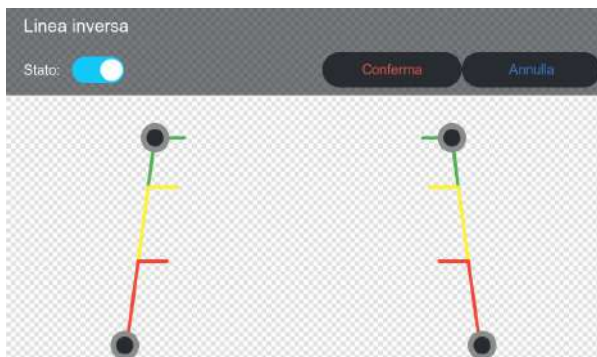

Parcheeggiare l'auto al centro del parcheggio.



Tieni premuta la X per regolare la posizione e l'angolazione della linea di retromarcia, assicurati che la linea di parcheggio sia orizzontale rispetto al suolo.



Fare clic su [conferma] per salvare la calibrazione.

## FAQ:

1. Poiché la corrente di uscita è instabile all'avvio dell'auto, spegnere l'FM prima di fermare l'auto, altrimenti l'FM farà rumore quando si riaccende l'auto.
2. Quando si utilizza l'FM per collegare il carplay, si prega di non utilizzare la stessa frequenza della trasmissione, altrimenti il carplay sarà un salto di frequenza e nessun suono. puoi utilizzare il cavo AUX per collegare il carplay, che può risolvere efficacemente questo problema.
3. Alcuni telefoni Android potrebbero avere problemi di connessione wireless a causa di marche e versioni di sistema diverse. Quindi offriamo una connessione cablata per il telefono Android.  
Metodo: c'è una porta USB sul cavo del caricatore per auto, puoi collegare il tuo telefono Android alla porta USB tramite il cavo dati del telefono originale.
4. Prima di riconnettersi, attivare Bluetooth e WIFI, il sistema collegherà automaticamente il telefono cellulare.
5. Secondo il nostro suggerimento, collegare il circuito di alimentazione ed evitare interferenze quando la macchina viene avviata.







