



OPERATOR'S MANUAL

Metal Working



Book 1 of 2

HYDRAULIC PRESS BRAKE MODEL: BP-7098CNC

Baileigh Industrial Holdings LLC
P.O. Box 531
Manitowoc, WI 54221-0531
Phone: 920.684.4990
Fax: 920.684.3944
sales@baileigh.com

REPRODUCTION OF THIS MANUAL IN ANY FORM WITHOUT WRITTEN APPROVAL OF BAILEIGH INDUSTRIAL HOLDINGS LLC IS PROHIBITED. Baileigh Industrial Holdings LLC, Inc. does not assume and hereby disclaims any liability for any damage or loss caused by an omission or error in this Operator's Manual, resulting from accident, negligence, or other occurrence.



Table of Contents

THANK YOU & WARRANTY	1
INTRODUCTION.....	3
GENERAL NOTES.....	3
SAFETY INSTRUCTIONS	4
SAFETY PRECAUTIONS	7
Dear Valued Customer:.....	7
TECHNICAL SPECIFICATIONS	9
TECHNICAL SUPPORT	9
UNPACKING AND CHECKING CONTENTS.....	10
TRANSPORTING AND LIFTING	11
INSTALLATION.....	12
Anchoring the Machine.....	13
Tank Filling	13
GETTING TO KNOW YOUR MACHINE	15
Safety Equipment	21
Assembly	22
ELECTRICAL.....	24
Power Supply	25
Power cord connection:	26
ELECTRICAL SYSTEM OPERATION	27
Switch and Button Functions	27
CONTROL PRINCIPLE OF YSD6000D.....	29
Controls of Mechanical Stop Adjust (Y-Axis) and Back Gauge (X-Axis).....	29
OPERATION INSTRUCTION, YSD6000D.....	30
Keys	30
Display Screen	32
MACHINE OPERATION	33
Start Up	33
Shutdown	33
Emergency Stop Button.....	33
PROGRAMMING	36
Bending Operation.....	37
Multi-Step Programming.....	41
ALARM.....	46
Appendix A Common Fault and Troubleshooting	47
Appendix B Alarm List.....	48
Appendix C Parameter Description	49
HYDRAULIC SYSTEM INTRODUCTION	51
Hydraulic Oil	51
Replacing Hydraulic Oil	52
PRESSURE ADJUSTMENT	53
Calculation Formula.....	53



Determine Bending Force with Bending Chart..... 54



THANK YOU & WARRANTY

Thank you for your purchase of a machine from Baileigh Industrial Holdings LLC. We hope that you find it productive and useful to you for a long time to come.

Inspection & Acceptance. Buyer shall inspect all Goods within ten (10) days after receipt thereof. Buyer's payment shall constitute final acceptance of the Goods and shall act as a waiver of the Buyer's rights to inspect or reject the goods unless otherwise agreed. If Buyer rejects any merchandise, Buyer must first obtain a Returned Goods Authorization ("RGA") number before returning any goods to Seller. Goods returned without an RGA will be refused. Seller will not be responsible for any freight costs, damages to goods, or any other costs or liabilities pertaining to goods returned without a RGA. Seller shall have the right to substitute a conforming tender. Buyer will be responsible for all freight costs to and from Buyer and repackaging costs, if any, if Buyer refuses to accept shipment. If Goods are returned in unsalable condition, Buyer shall be responsible for full value of the Goods. Buyer may not return any special-order Goods. Any Goods returned hereunder shall be subject to a restocking fee equal to 30% of the invoice price.

Specifications. Seller may, at its option, make changes in the designs, specifications or components of the Goods to improve the safety of such Goods, or if in Seller's judgment, such changes will be beneficial to their operation or use. Buyer may not make any changes in the specifications for the Goods unless Seller approves of such changes in writing, in which event Seller may impose additional charges to implement such changes.

Limited Warranty. Seller warrants to the original end-user that the Goods manufactured or provided by Seller under this Agreement shall be free of defects in material or workmanship for a period of twelve (12) months from the date of purchase, provided that the Goods are installed, used, and maintained in accordance with any instruction manual or technical guidelines provided by the Seller or supplied with the Goods, if applicable. The original end-user must give written notice to Seller of any suspected defect in the Goods prior to the expiration of the warranty period. The original end-user must also obtain a RGA from Seller prior to returning any Goods to Seller for warranty service under this paragraph. Seller will not accept any responsibility for Goods returned without a RGA. The original end-user shall be responsible for all costs and expenses associated with returning the Goods to Seller for warranty service. In the event of a defect, Seller, at its sole option, shall repair or replace the defective Goods or refund to the original end-user the purchase price for such defective Goods. Goods are not eligible for replacement or return after a period of 10 days from date of receipt. The foregoing warranty is Seller's sole obligation, and the original end-user's exclusive remedy, with regard to any defective Goods. This limited warranty does not apply to: (a) die sets, tooling, and saw blades; (b) periodic or routine maintenance and setup, (c) repair or replacement of the Goods due to normal wear and tear, (d) defects or damage to the Goods resulting from misuse, abuse, neglect, or accidents, (e) defects or damage to the Goods resulting from improper or unauthorized alterations, modifications, or changes; and (f) any Goods that has not been installed and/or maintained in accordance with the instruction manual or technical guidelines provided by Seller.

EXCLUSION OF OTHER WARRANTIES. THE FOREGOING LIMITED WARRANTY IS IN LIEU OF ALL OTHER WARRANTIES, EXPRESS OR IMPLIED. ANY AND ALL OTHER EXPRESS, STATUTORY OR IMPLIED WARRANTIES, INCLUDING BUT NOT LIMITED TO, ANY WARRANTY OF MERCHANTABILITY OR FITNESS FOR ANY PARTICULAR PURPOSE ARE EXPRESSLY DISCLAIMED. NO WARRANTY IS MADE WHICH EXTENDS BEYOND THAT WHICH IS EXPRESSLY CONTAINED HEREIN.

Limitation of Liability. IN NO EVENT SHALL SELLER BE LIABLE TO BUYER OR ANY OTHER PARTY FOR ANY INCIDENTAL, CONSEQUENTIAL OR SPECIAL DAMAGES (INCLUDING, WITHOUT LIMITATION, LOST PROFITS OR DOWN TIME) ARISING FROM OR IN MANNER CONNECTED WITH THE GOODS, ANY BREACH BY SELLER OR ITS AGENTS OF THIS AGREEMENT, OR ANY OTHER CAUSE WHATSOEVER, WHETHER BASED ON CONTRACT, TORT OR ANY OTHER THEORY OF LIABILITY. BUYER'S REMEDY WITH RESPECT TO ANY CLAIM ARISING UNDER THIS AGREEMENT IS STRICTLY LIMITED TO NO MORE THAN THE AMOUNT PAID BY THE BUYER FOR THE GOODS.



Force Majeure. Seller shall not be responsible for any delay in the delivery of, or failure to deliver, Goods due to causes beyond Seller's reasonable control including, without limitation, acts of God, acts of war or terrorism, enemy actions, hostilities, strikes, labor difficulties, embargoes, non-delivery or late delivery of materials, parts and equipment or transportation delays not caused by the fault of Seller, delays caused by civil authorities, governmental regulations or orders, fire, lightening, natural disasters or any other cause beyond Seller's reasonable control. In the event of any such delay, performance will be postponed by such length of time as may be reasonably necessary to compensate for the delay.

Installation. If Buyer purchases any Goods that require installation, Buyer shall, at its expense, make all arrangements and connections necessary to install and operate the Goods. Buyer shall install the Goods in accordance with any Seller instructions and shall indemnify Seller against any and all damages, demands, suits, causes of action, claims and expenses (including actual attorneys' fees and costs) arising directly or indirectly out of Buyer's failure to properly install the Goods.

Work By Others; Safety Devices. Unless agreed to in writing by Seller, Seller has no responsibility for labor or work performed by Buyer or others, of any nature, relating to design, manufacture, fabrication, use, installation or provision of Goods. Buyer is solely responsible for furnishing and requiring its employees and customers to use all safety devices, guards and safe operating procedures required by law and/or as set forth in manuals and instruction sheets furnished by Seller. Buyer is responsible for consulting all operator manuals, ANSI or comparable safety standards, OSHA regulations and other sources of safety standards and regulations applicable to the use and operation of the Goods.

Remedies. Each of the rights and remedies of Seller under this Agreement is cumulative and in addition to any other or further remedies provided under this Agreement or at law or equity.

Attorney's Fees. In the event legal action is necessary to recover monies due from Buyer or to enforce any provision of this Agreement, Buyer shall be liable to Seller for all costs and expenses associated therewith, including Seller's actual attorney fees and costs.

Governing Law/Venue. This Agreement shall be construed and governed under the laws of the State of Wisconsin, without application of conflict of law principles. Each party agrees that all actions or proceedings arising out of or in connection with this Agreement shall be commenced, tried, and litigated only in the state courts sitting in Manitowoc County, Wisconsin or the U.S. Federal Court for the Eastern District of Wisconsin. Each party waives any right it may have to assert the doctrine of "forum non conveniens" or to object to venue to the extent that any proceeding is brought in accordance with this section. Each party consents to and waives any objection to the exercise of personal jurisdiction over it by courts described in this section. Each party waives to the fullest extent permitted by applicable law the right to a trial by jury.

Summary of Return Policy.

- 10 Day acceptance period from date of delivery. Damage claims and order discrepancies will not be accepted after this time.
- You must obtain a Baileigh issued RGA number PRIOR to returning any materials.
- Returned materials must be received at Baileigh in new condition and in original packaging.
- Altered items are not eligible for return.
- Buyer is responsible for all shipping charges.
- A 30% re-stocking fee applies to all returns.

Baileigh Industrial Holdings LLC makes every effort to ensure that our posted specifications, images, pricing and product availability are as correct and timely as possible. We apologize for any discrepancies that may occur. Baileigh Industrial Holdings LLC reserves the right to make any and all changes deemed necessary in the course of business including but not limited to pricing, product specifications, quantities, and product availability.

For Customer Service & Technical Support:

Please contact one of our knowledgeable Sales and Service team members at:
(920) 684-4990 or e-mail us at sales@baileigh.com



INTRODUCTION

The quality and reliability of the components assembled on a Baileigh Industrial Holdings LLC machine guarantee near perfect functioning, free from problems, even under the most demanding working conditions. However, if a situation arises, refer to the manual first. If a solution cannot be found, contact the distributor where you purchased our product. Make sure you have the serial number and production year of the machine (stamped on the nameplate). For replacement parts refer to the assembly numbers on the parts list drawings.

Our technical staff will do their best to help you get your machine back in working order.

In this manual you will find: (when applicable)

- Safety procedures
- Correct installation guidelines
- Description of the functional parts of the machine
- Capacity charts
- Setup and start-up instructions
- Machine operation
- Scheduled maintenance
- Parts lists

GENERAL NOTES

After receiving your equipment remove the protective container. Do a complete visual inspection, and if damage is noted, **photograph it for insurance claims** and contact your carrier at once, requesting inspection. Also contact Baileigh Industrial Holdings LLC and inform them of the unexpected occurrence. Temporarily suspend installation.

Take necessary precautions while loading / unloading or moving the machine to avoid any injuries.

Your machine is designed and manufactured to work smoothly and efficiently. Following proper maintenance instructions will help ensure this. Try and use original spare parts, whenever possible, and most importantly; **DO NOT** overload the machine or make any modifications.



Note: *This symbol refers to useful information throughout the manual.*



IMPORTANT

PLEASE READ THIS OPERATORS MANUAL CAREFULLY

It contains important safety information, instructions, and necessary operating procedures. The continual observance of these procedures will help increase your production and extend the life of the equipment.



SAFETY INSTRUCTIONS

LEARN TO RECOGNIZE SAFETY INFORMATION

This is the safety alert symbol. When you see this symbol on your machine or in this manual, **BE ALERT TO THE POTENTIAL FOR PERSONAL INJURY!**



Follow recommended precautions and safe operating practices.

UNDERSTAND SIGNAL WORDS

A signal word – **DANGER**, **WARNING**, or **CAUTION** – is used with the safety alert symbol. **NOTICE**, which is not related to personal injury, is used without a symbol.

DANGER: Indicates a hazardous situation which, if not avoided, will result in death or serious injury.

WARNING: Indicates a hazardous situation which, if not avoided, could result in death or serious injury.

CAUTION: Indicates a hazardous situation which, if not avoided, could result in minor or moderate injury.

NOTICE: Indicates a situation which, if not avoided, could result in property damage.



DANGER



WARNING



CAUTION



NOTICE



SAVE THESE INSTRUCTIONS.
Refer to them often and use them to instruct others.



PROTECT EYES

Wear safety glasses or suitable eye protection when working on or around machinery.

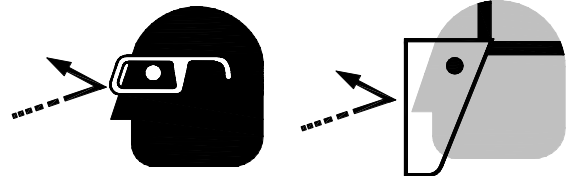

PROTECT AGAINST NOISE

Prolonged exposure to loud noise can cause impairment or loss of hearing. Wear suitable hearing protective devices such as ear muffs or earplugs to protect against objectionable or uncomfortable loud noises.

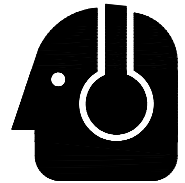

HYDRAULIC HOSE FAILURE

Exercise **CAUTION** around hydraulic hoses in case of a hose or fitting failure.

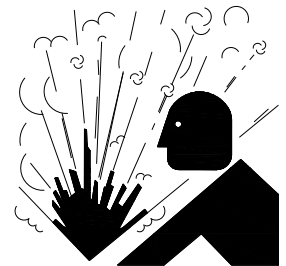

BEWARE OF CRUSH HAZARD

NEVER place your hands, fingers, or any part of your body in the die area of this machine.

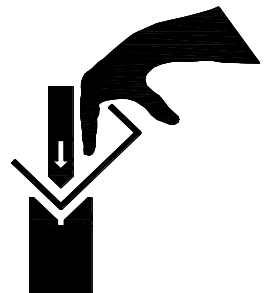
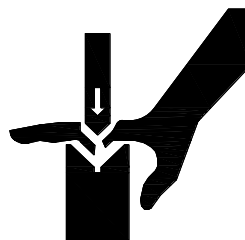

BEWARE OF PINCH POINTS

Keep hands and fingers away from the servo motors drive belt and pulleys when performing maintenance. Keep motor guards in place at all times while the machine is running.

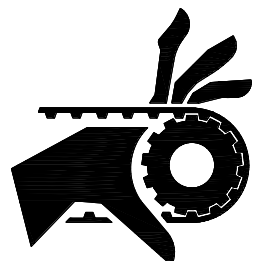



KEEP CLEAR OF MOVING OBJECTS

Always be aware of the position of the clamp handle and the counterweight. They are heavy and can swing back suddenly causing serious body or head injuries.

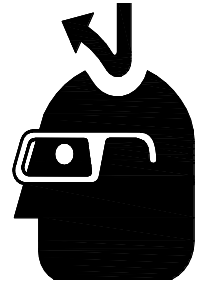

BEWARE OF CRUSH HAZARD

NEVER place your hands, fingers, or any part of your body in the die area of this machine.

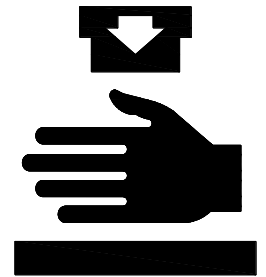

HIGH VOLTAGE

USE CAUTION IN HIGH VOLTAGE AREAS. DO NOT assume the power to be off.
FOLLOW PROPER LOCKOUT PROCEDURES.



EMERGENCY STOP BUTTON

In the event of incorrect operation or dangerous conditions, the machine can be stopped immediately by pressing the **E-STOP** button. Twist the emergency stop button clockwise (cw) to reset. Note: Resetting the E-Stop will not start the machine.





SAFETY PRECAUTIONS



Metal working can be dangerous if safe and proper operating procedures are not followed. As with all machinery, there are certain hazards involved with the operation of the product. Using the machine with respect and caution will considerably lessen the possibility of personal injury. However, if normal safety precautions are overlooked or ignored, personal injury to the operator may result.

Safety equipment such as guards, hold-downs, safety glasses, dust masks and hearing protection can reduce your potential for injury. But even the best guard won't make up for poor judgment, carelessness or inattention. Always use common sense and exercise caution in the workshop. If a procedure feels dangerous, don't try it.

REMEMBER: Your personal safety is your responsibility.



WARNING: FAILURE TO FOLLOW THESE RULES MAY RESULT IN SERIOUS PERSONAL INJURY

Dear Valued Customer:

- All Baileigh machines should be used only for their intended use.
- Baileigh does not recommend or endorse making any modifications or alterations to a Baileigh machine. Modifications or alterations to a machine may pose a substantial risk of injury to the operator or others and may do substantial damage to the machine.
- Any modifications or alterations to a Baileigh machine will invalidate the machine's warranty.

PLEASE ENJOY YOUR BAILEIGH MACHINE!PLEASE ENJOY IT SAFELY!

1. **FOR YOUR OWN SAFETY, READ INSTRUCTION MANUAL BEFORE OPERATING THE MACHINE.** Learn the machine's application and limitations as well as the specific hazards.
2. **Only trained and qualified personnel can operate this machine.**
3. **Make sure guards are in place and in proper working order before operating machinery.**
4. **Remove any adjusting tools.** Before operating the machine, make sure any adjusting tools have been removed.
5. **Keep work area clean.** Cluttered areas invite injuries.
6. **Overloading machine.** By overloading the machine you may cause injury from flying parts. **DO NOT** exceed the specified machine capacities.



7. **Dressing material edges.** Before bending sheet metal, always chamfer and deburr all sharp edges.
8. **Do not force tool.** Your machine will do a better and safer job if used as intended. **DO NOT** use inappropriate attachments in an attempt to exceed the machines rated capacity.
9. **Use the right tool for the job. DO NOT** attempt to force a small tool or attachment to do the work of a large industrial tool. **DO NOT** use a tool for a purpose for which it was not intended.
10. **Dress appropriate. DO NOT** wear loose fitting clothing or jewelry as they can be caught in moving machine parts. Protective clothing and steel toe shoes are recommended when using machinery. Wear a restrictive hair covering to contain long hair.
11. **Use eye and ear protection.** Always wear ISO approved impact safety goggles. Wear a full-face shield if you are producing metal filings.
12. **Do not overreach.** Maintain proper footing and balance at all times. **DO NOT** reach over or across a running machine.
13. **Stay alert.** Watch what you are doing and use common sense. **DO NOT** operate any tool or machine when you are tired.
14. **Check for damaged parts.** Before using any tool or machine, carefully check any part that appears damaged. Check for alignment and binding of moving parts that may affect proper machine operation.
15. **Observe work area conditions. DO NOT** use machines or power tools in damp or wet locations. Do not expose to rain. Keep work area well lighted. **DO NOT** use electrically powered tools in the presence of flammable gases or liquids.
16. **Blade adjustments and maintenance.** Always keep blades sharp and properly adjusted for optimum performance.
17. **Keep children away.** Children must never be allowed in the work area. **DO NOT** let them handle machines, tools, or extension cords.
18. **Store idle equipment.** When not in use, tools must be stored in a dry location to inhibit rust. Always lock up tools and keep them out of reach of children.
19. **DO NOT operate machine if under the influence of alcohol or drugs.** Read warning labels on prescriptions. If there is any doubt, **DO NOT** operate the machine.
20. **DO NOT** touch live electrical components or parts.
21. Be sure all equipment is properly installed and grounded according to national, state, and local codes.
22. **DO NOT** bypass or defeat any safety interlock systems.
23. Keep visitors a safe distance from the work area.



TECHNICAL SPECIFICATIONS

Table Length x Width	98" x 5.5" (2500 x 140mm)
Back Gauge Length	23.62" (600mm)
Maximum Pressure	70 tons (63.5metric tons)
Throat Depth	11.8" (300mm)
Distance Between Housings	80.7" (2050mm)
Distance – Table to Ram	11.8" (300mm)
Stroke Distance	3.9" (100mm)
Adjustment of Ram Travel	3.1" (80mm)
Approach Speed	3.9"/sec. (100mm/sec.)
Working Speed	.275"/sec. (7mm/sec.)
Return Speed	3.46"/sec. (88mm/sec.)
Power	220V / 3-phase / 60HZ / 19A
Main Motor	5.5hp (4kw) 15.2A
Axis Servo Motors	1/4hp (.19kw) .5A
Hydraulic Reservoir Capacity	29gal. (110L)
Maximum Hydraulic Pressure	4500psi (31MPa)
Shipping Weight	100321lbs. (4550kg)
Shipping Dimensions	107"x52"x85" (2718x1321x2159mm)
Based on a material tensile strength of 64000 PSI – mild steel	

TECHNICAL SUPPORT

Our technical support department can be reached at 920.684.4990 and asking for the support desk for purchased machines. Tech Support handles questions on machine setup, schematics, warranty issues, and individual parts needs: (other than die sets and blades).

For specific application needs or future machine purchases contact the Sales Department at: sales@baileigh.com, Phone: 920.684.4990, or Fax: 920.684.3944.



Note: *The photos and illustrations used in this manual are representative only and may not depict the actual color, labeling or accessories and may be intended to illustrate technique only.*



Note: *The specifications and dimensions presented here are subject to change without prior notice due to improvements of our products.*



UNPACKING AND CHECKING CONTENTS

Your Baileigh machine is shipped complete. Separate all parts from the packing material and check each item carefully. Make certain all items are accounted for before discarding any packing material.

⚠ WARNING: SUFFOCATION HAZARD! Immediately discard any plastic bags and packing materials to eliminate choking and suffocation hazards to children and animals.
If any parts are missing, **DO NOT** place the machine into service until the missing parts are obtained and installed correctly.

Cleaning

⚠ WARNING: DO NOT USE gasoline or other petroleum products to clean the machine. They have low flash points and can explode or cause fire.

⚠ CAUTION: When using cleaning solvents work in a well-ventilated area. Many cleaning solvents are toxic if inhaled.

Your machine may be shipped with a rustproof waxy coating and/or grease on the exposed unpainted metal surfaces. Fully and completely remove this protective coating using a degreaser or solvent cleaner. Moving items will need to be moved along their travel path to allow for cleaning the entire surface. For a more thorough cleaning, some parts will occasionally have to be removed. **DO NOT USE** acetone or brake cleaner as they may damage painted surfaces.

Follow manufacturer's label instructions when using any type of cleaning product. After cleaning, wipe unpainted metal surfaces with a light coating of quality oil or grease for protection.



Important: This waxy coating is **NOT** a lubricant and will cause the machine to stick and lose performance as the coating continues to dry.





TRANSPORTING AND LIFTING

⚠ CAUTION: Lifting and carrying operations should be carried out by skilled workers, such as a truck operator, crane operator, etc. If a crane is used to lift the machine, attach the lifting chain carefully, making sure the machine is well balanced. Choose a location that will keep the machine free from vibration and dust from other machinery. Keep in mind that having a large clearance area around the machine is important for safe and efficient working conditions.

Follow these guidelines when lifting:

- Always lift and carry the machine with the lifting holes provided at the top of the machine.
- Use lift equipment such as straps, chains, capable of lifting 1.5 to 2 times the weight of the machine.
- Take proper precautions for handling and lifting.
- Check if the load is properly balanced by lifting it an inch or two.
- Lift the machine, avoiding sudden accelerations or quick changes of direction.
- Locate the machine where it is to be installed, and lower slowly until it touches the floor.

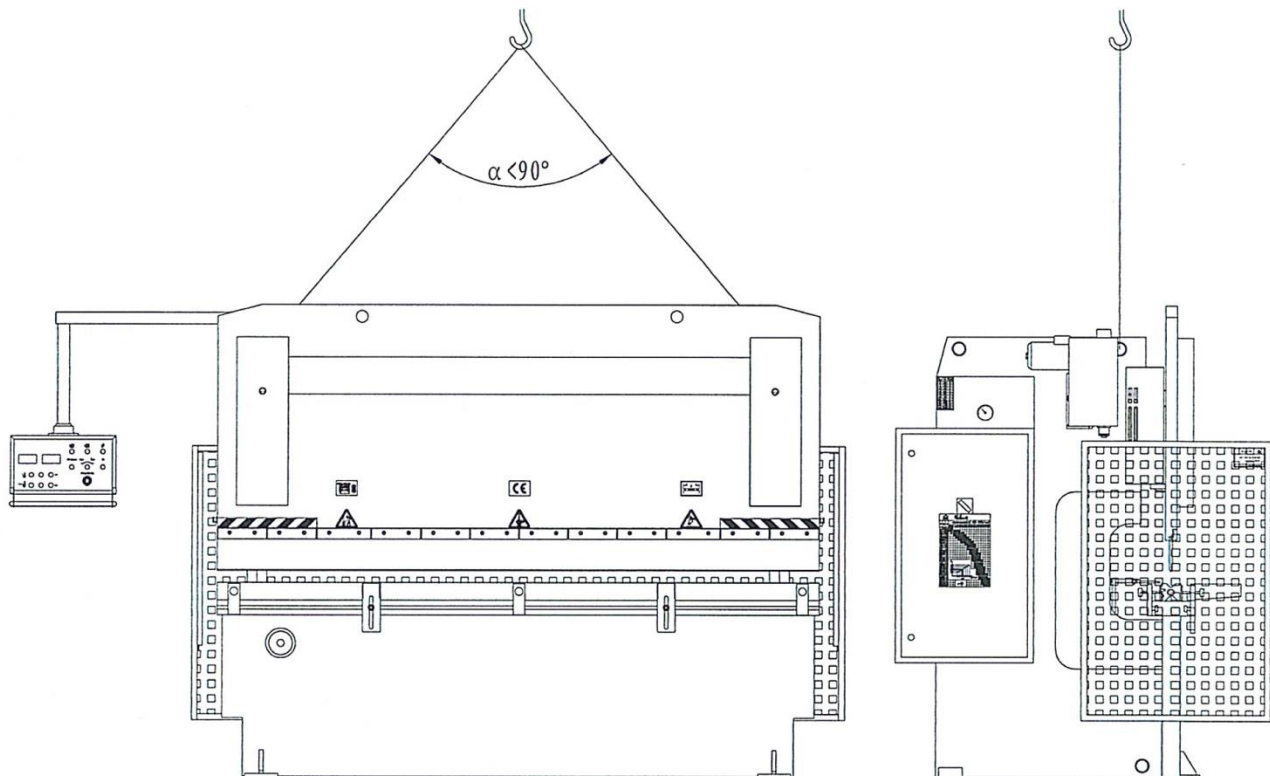



INSTALLATION

IMPORTANT:

Consider the following when looking for a suitable location to place the machine:

- Overall weight of the machine.
- Weight of material being processed.
- Sizes of material to be processed through the machine.
- Space needed for auxiliary stands, work tables, or other machinery.
- Clearance from walls and other obstacles.
- Maintain an adequate working area around the machine for safety.
- Have the work area well illuminated with proper lighting.
- Keep the floor free of oil and make sure it is not slippery.
- Remove scrap and waste materials regularly, and make sure the work area is free from obstructing objects.
- If long lengths of material are to be fed into the machine, make sure that they will not extend into any aisles.

Before beginning assembly, take note of the following precautions and suggestions.

- Is the machine is bolted to the pallet? Before attempting any of the assembly procedures remove all of the loose parts and hardware and unbolt the machine from the pallet.
- **LEVELING:** The machine should be sited on a level, concrete floor. Provisions for securing it should be in position prior to placing the machine. The accuracy of any machine depends on the precise placement of it to the mounting surface.
- **FLOOR:** This tool distributes a large amount of weight over a small area. Make certain that the floor is capable of supporting the weight of the machine, work stock, and the operator. The floor should also be a level surface. If the unit wobbles or rocks once in place, be sure to eliminate by using shims.
- **WORKING CLEARANCES:** Take into consideration the size of the material to be processed. Make sure that you allow enough space for you to operate the machine freely.
- **POWER SUPPLY PLACEMENT:** The power supply should be located close enough to the machine so that the power cord is not in an area where it would cause a tripping hazard. Be sure to observe all electrical codes if installing new circuits and/or outlets.



Leveling

Horizontal Adjusting:

Placing the level at each point (the distance between ends and points is 50mm. Adjust the anchor bolt until the horizontal leveling accuracy is within 0.2/1000mm.

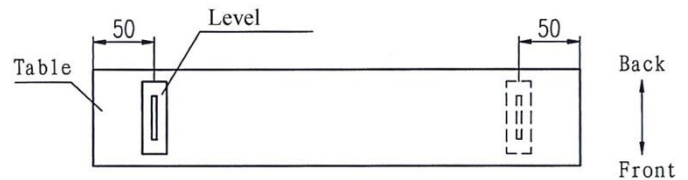

Vertical Adjusting:

For the vertical direction of table has crowning (a curve which treats the middle part as axis), you must place gauge block on the table. Then put the leveling rule on the gauge block; put the level on the leveling rule. Adjusting the anchor bolt until the vertical leveling accuracy is within 0.2/1000mm.

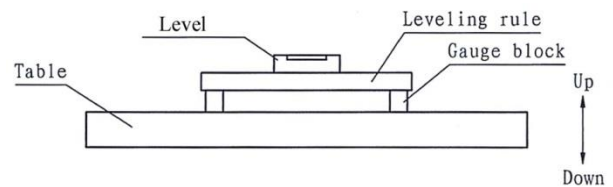

Anchoring the Machine

- Position the machine on a firm and level concrete floor and maintain a safe operating distance around the machine.
- Anchor the machine to the floor, as shown in the diagram, using bolts and expansion plugs or sunken tie rods that connect through holes in the base of the stand.

Tank Filling

The hydraulic oil is the primary medium for transmitting pressure and also must lubricate the running parts of the pump.

After installation of the machine and before machine startup, bring the oil level up to 90% of capacity. Verify that any cylinder rams are in the retracted position to prevent overfilling of the tank. Recheck the oil level after the first few hours of operation and again after the first full week of operation.

A shortage of hydraulic oil can cause hydraulic system breakdown and damage to major mechanical parts due to overheating.

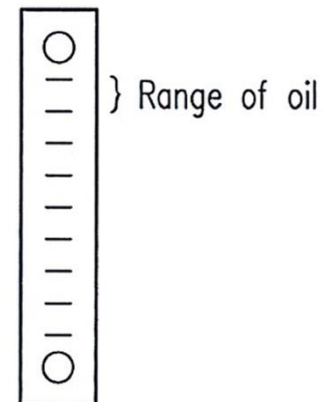

Oil gauge

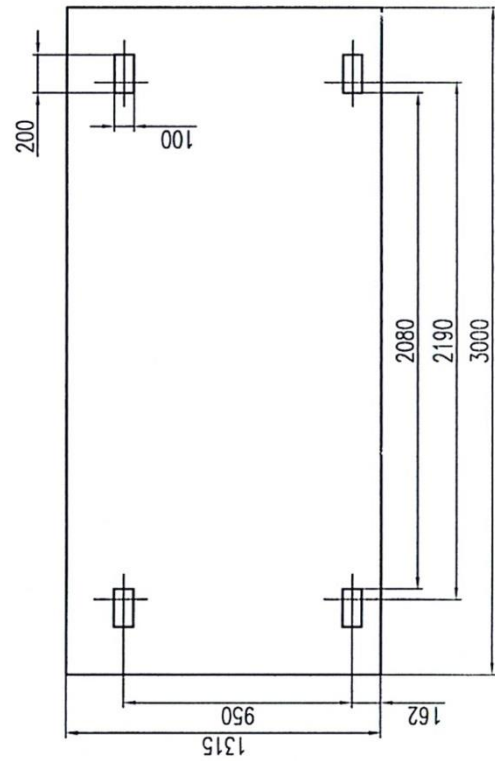
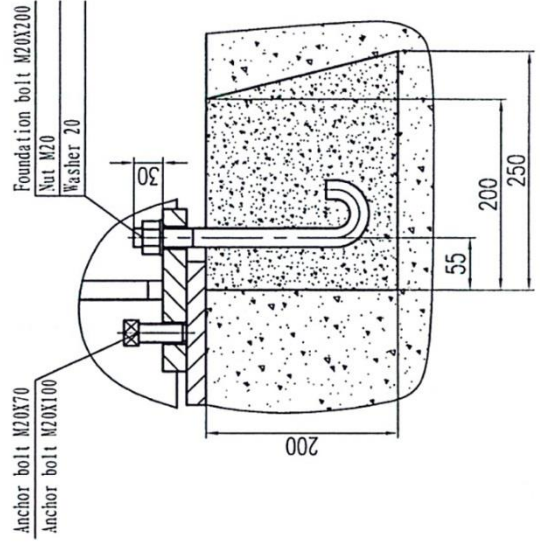
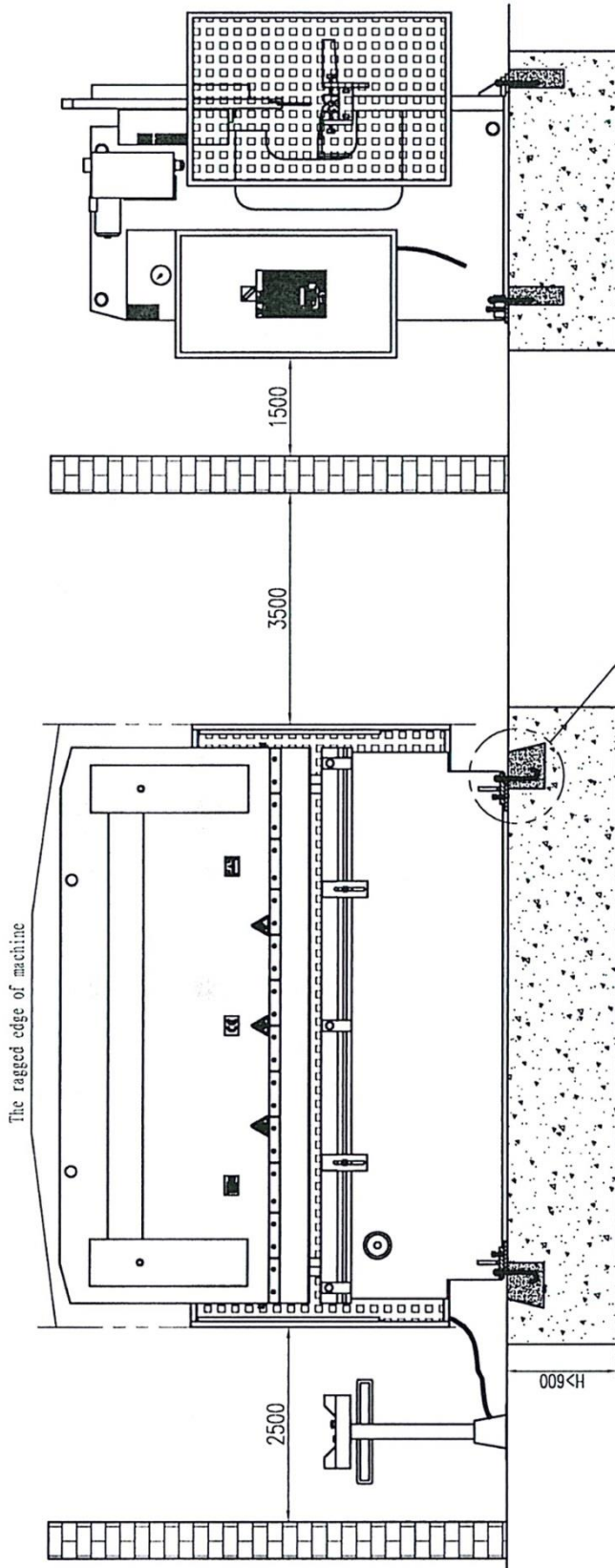



GETTING TO KNOW YOUR MACHINE

Hydraulic press brake is intended for bending and forming sheets metals. Normally, after one stroke of ram, the sheet can be bent into certain geometry sharp. If after several times bending, it can get complex sectional sharps. The machine can completely bend the full length of the sheet with high accuracy.

The machine uses hydraulic and electric control system. Top Die Position (T.D.P.) and Bend Speed Point (B.S.P.) use electric control. Proper position can be chosen quickly and easily based on the technique requirements of bended material.

The machine has pressure-returning function. It means that if bending pressure reaches maximum system pressure, the pressure gauge sends signal causing the ram to return.

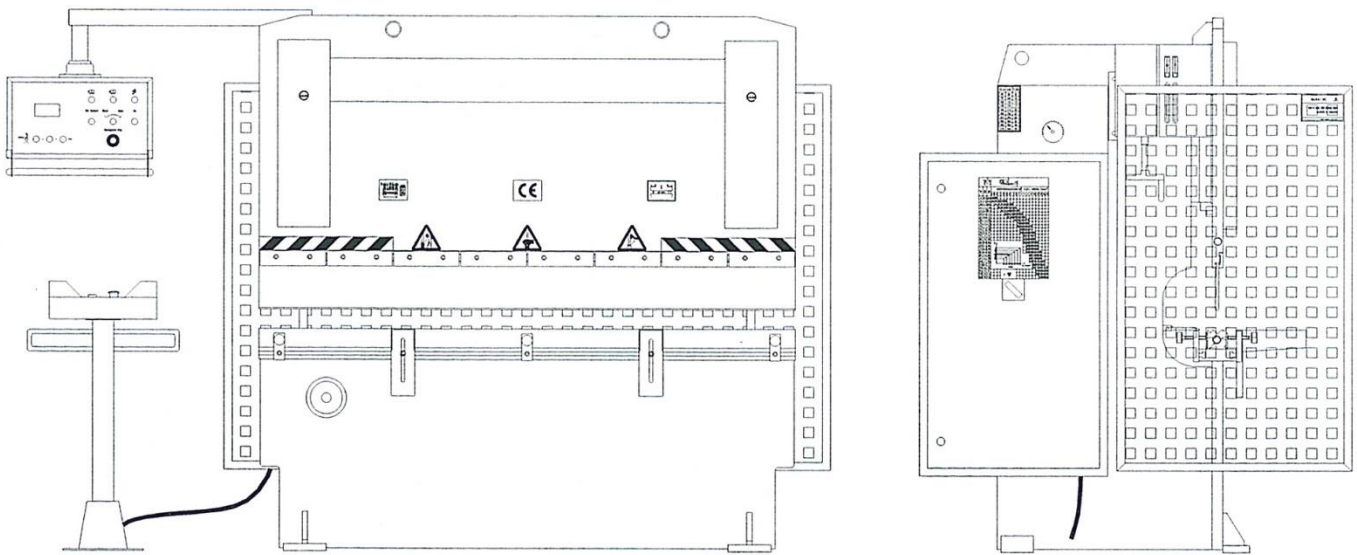

Note: This drawing reflects the scheme of machine, only for reference.
practicality may be difference



Terms:

1. Press brake - the machine which bending the plate or sheet by relative moving of the dies.
2. Hydraulic press brake - press brake which driving ram by hydraulic.
3. Frame - structure of machine.
4. Upright - side pillar of frame.
5. Ram - part which fixing the die, then moving up and down.
6. Die - tool which bending and forming the sheets.
7. Die clamp - the part which fixing the die on ram and table.
8. Hanger - the part which lifting the die.
9. Nominal pressure - Maximum working pressure allowed.
10. Maximum working length - determining width.
11. Distance between uprights - the distance between insides of two uprights.
12. Ram stroke - the distance that ram moves between TDC and BDC.
13. Stroke adjustment - possible adjusting distance of BDC's position.
14. Open height - Maximum distance between ram's bottom and table's top.
15. Gap - the dimension between punch center of C bending machine and notch bottom of frame.
16. Back gauge distance - the distance between Back gauge and punch center.
17. Signal stroke - each starting, ram moves forward and return.
18. Inch - regular and intermission movement
19. TDP – Top Die Position, Maximum top position of movement
20. Shift Point – Point in the bending process when the limit switch is contacted, and the ram changes between the unloading speed and working speed. This is sometimes referred to as the Mute point, or Crossover point.
21. UDP (BDP) – Under Die Position, Maximum bottom position of movement.
22. Hydraulic drive - transiting movement and power by hydraulic.
23. Top drive - hydraulic system located on the table.
24. Down stroke - downward returning movement.

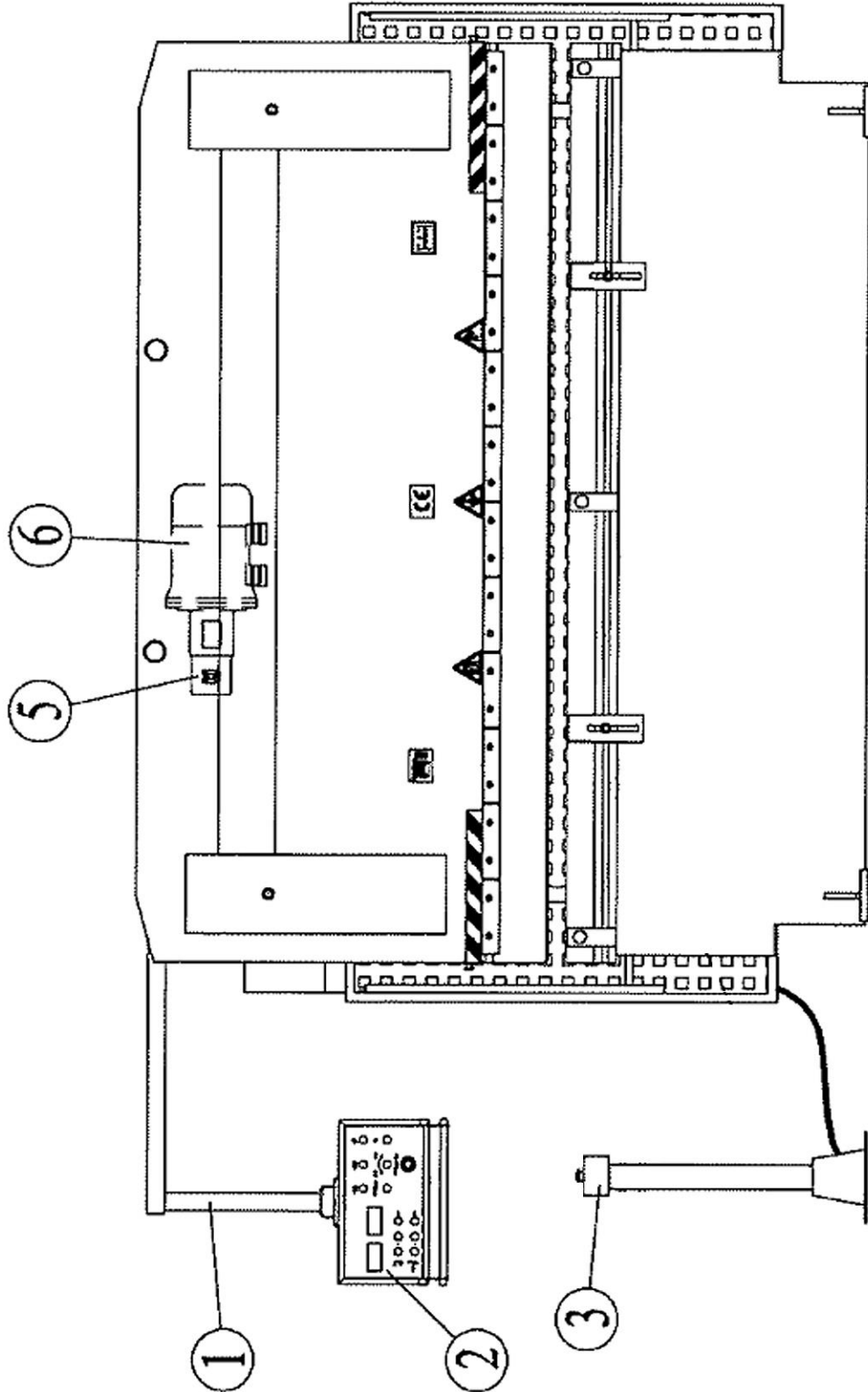

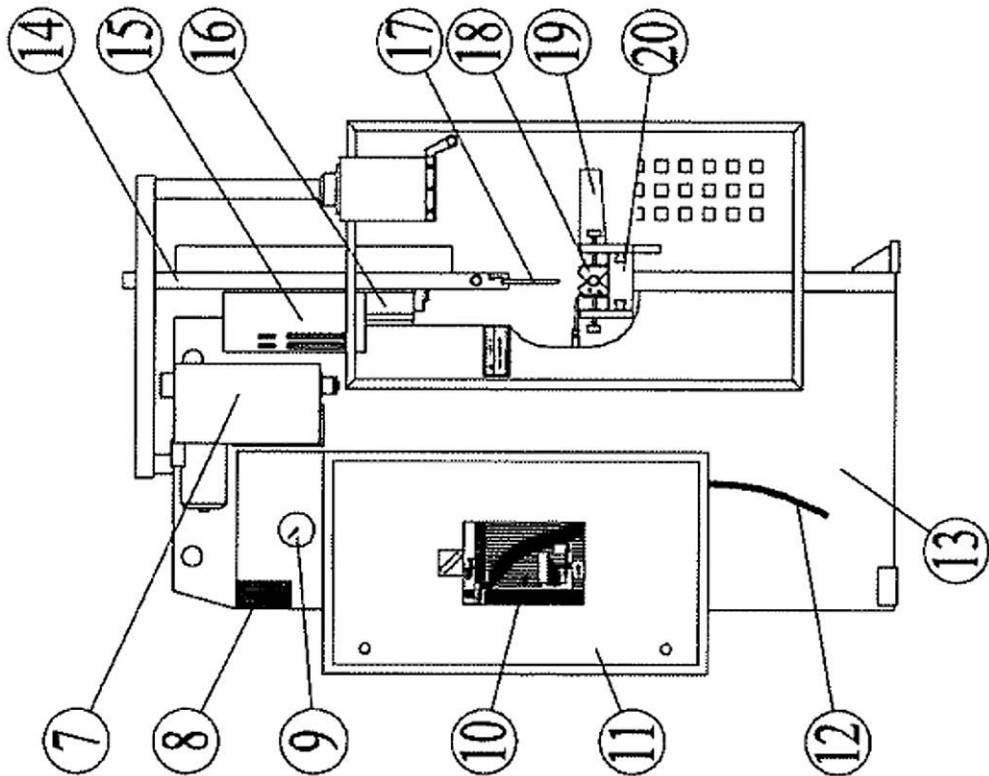
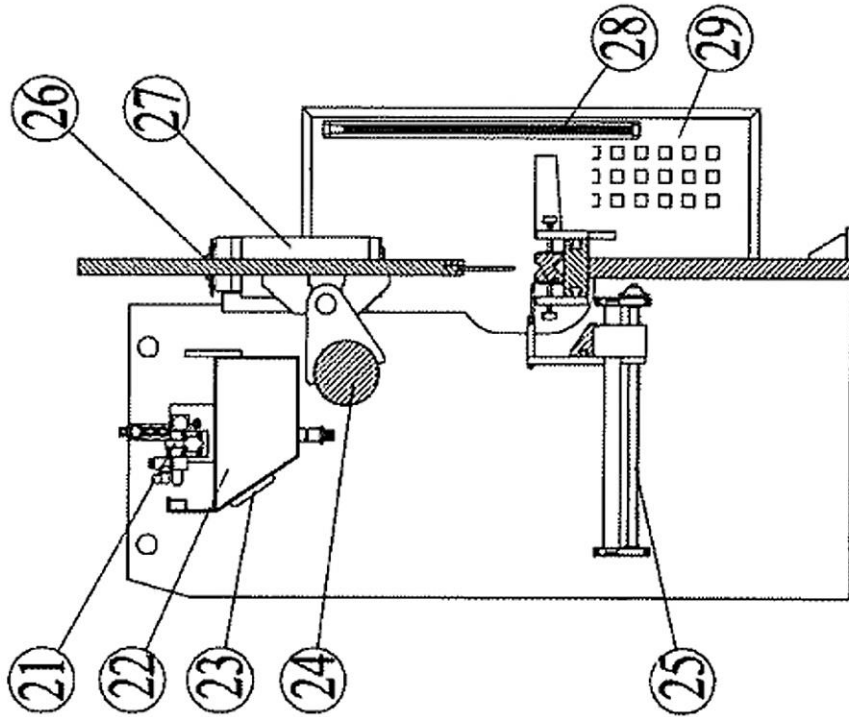



1	Control Support Arm	2	Hanging Controller
3	Foot Control Pedestal		
5	Hydraulic Pump	6	Motor
7	Y Axis Depth Control Mechanism	8	Pressure Conversion Decal
9	Bending Pressure Gauge	10	Bending Chart
11	Electrical Enclosure	12	Wire
13	Frame	14	Ram
15	Shift Point and Up Stroke Adjustment	16	Guide Bar
17	Punch	18	Die
19	Front Support	20	Table
21	Valve Block	22	Tank
23	Oil Gauge	24	Torsion Shaft
25	Back Gauge	26	Machinery Stop
27	Cylinder	28	Curtain
29	Safety Grid		

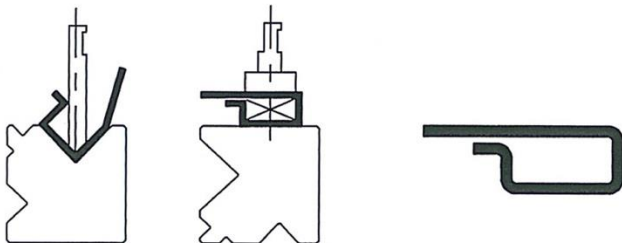
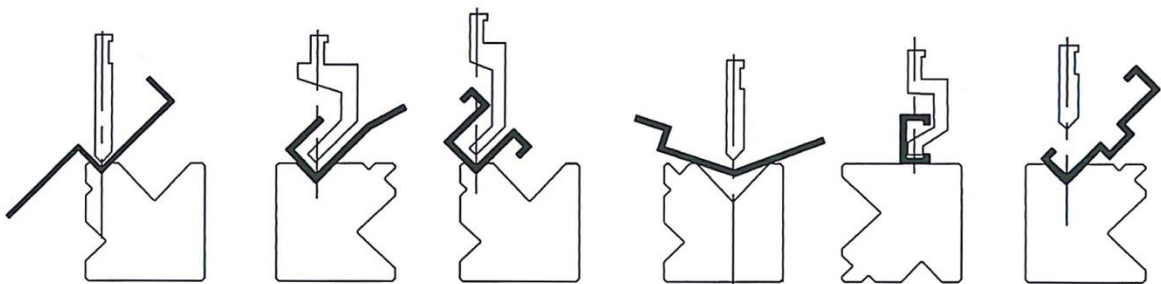
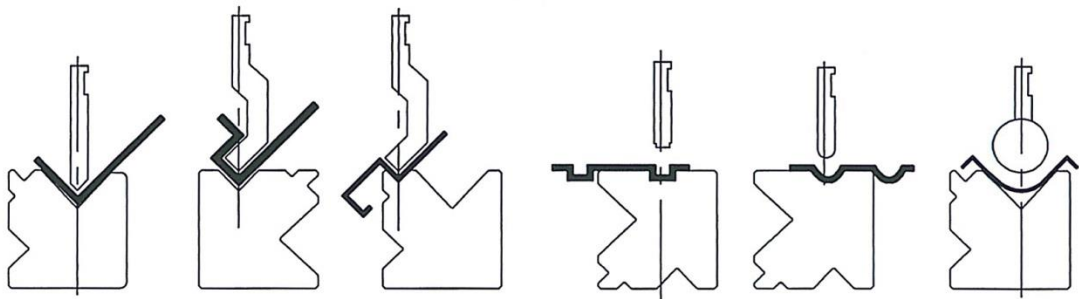
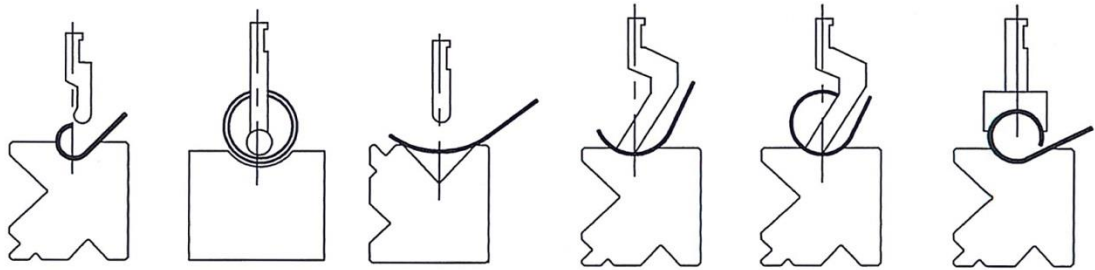
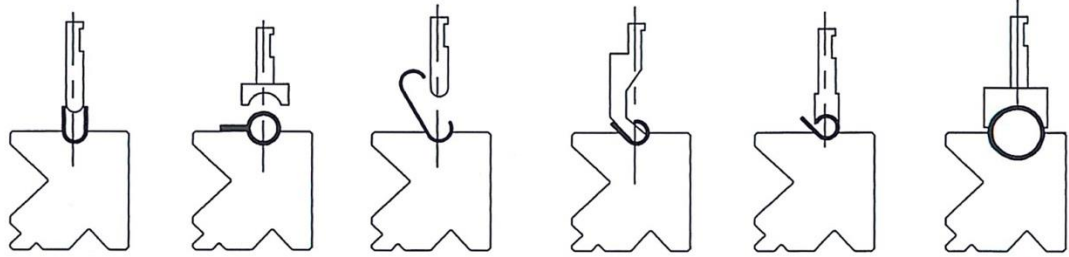

Note: The bends and tooling used for those bends is for reference only. Custom tooling has individual lead times and pricing and is non-returnable.



Safety Equipment

⚠ WARNING: This section describes the safety equipment installed on this machine so that the operator is aware of how it functions. Never remove, change, alter, disable, disconnect, etc. any of the safety equipment.

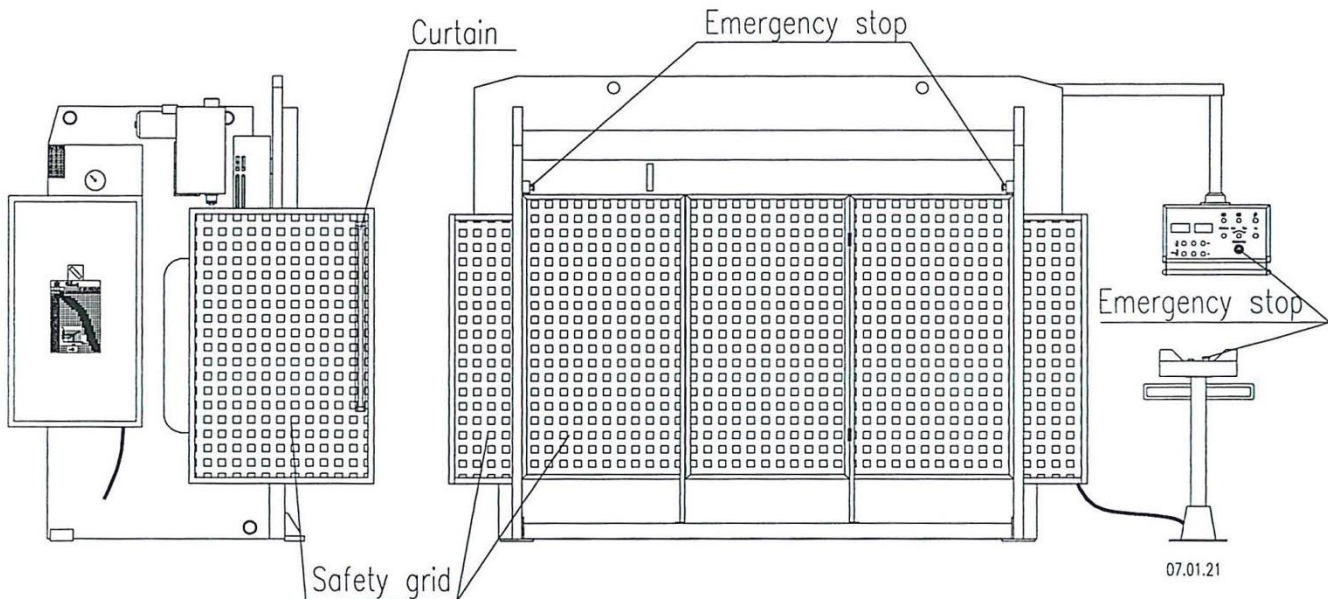

Light Curtain

Your press brake is equipped with an opto-electronic light curtain system mounted inside the side guard for point of operation safeguarding. This system is designed to safeguard the entire operating area from press bed to full opening, while maintaining user safety distance. Being designed to cover the entire working area, some applications may interrupt the light curtain causing the machine cycle to stop. These applications may include, but are not limited to, certain box shapes, small parts, etc... Accessories and tool sets may also interfere with light curtain operation. Accessories installed (including the optional supplied support arms) and mounted above bed level, extending toward the operator (past the light curtain) will stop the machine cycle. If your application interferes with light curtain operation, the end-user will need to re-mount or replace the safeguard system for their application per ANSI standard B11.3 Chapter 8, section 5.



Safety Guards

There are safety guards at side and back of machine. This is to prevent personal or objects from entering these areas while the machine is in operation. These safety guards are connected electrical to the system by safety switch. If any of the safety switches is activated, the machine will not operate.



Note: When the safety guard switch is activated, you will need to push the reset button to enable the electrical system.

Emergency Stop

There are 2 emergency stop buttons on the machine located on the hanging control station, pedestal control station. In the event of incorrect operation or dangerous conditions, the machine can be stopped immediately by pressing the E-STOP button. Twist the emergency stop button clockwise (cw) to reset. Note: Resetting the E-Stop will not start the machine.

Assembly

Front Support

The front support arms install on the front face of the worktable. The support can be mounted in any pair of the four mounting holes along the front face of the worktable. The support can be raised or lowered to align with the lower die as needed.

If your application interferes with light curtain operation, the owner will need to re-mount or replace the safeguard system for their application per ANSI standard B11.3 Chapter 8, section 5.

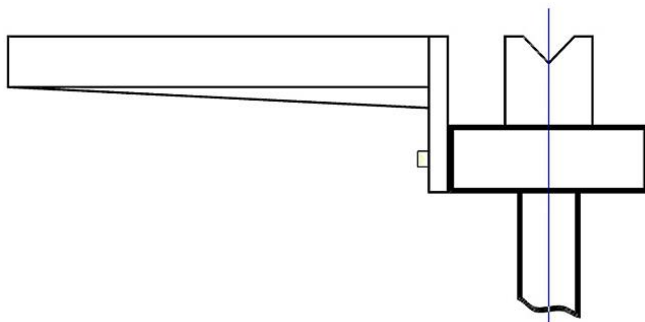



Foot Pedal Connection

Position the foot pedal and route the cable to the electrical enclosure in a manner that will allow easy access during operation but will minimize exposure of the foot pedal and cable to damage from being stepped on. Locate the connector on the underside of the electrical enclosure and align and secure the connector.



Tank Filling

The hydraulic oil is the primary medium for transmitting pressure and also must lubricate the running parts of the pump.

After installation of the machine and before machine startup, bring the oil level up to 90% of capacity. Verify that any cylinder rams are in the retracted position to prevent overfilling of the tank. Recheck the oil level after the first few hours of operation and again after the first full week of operation. Check hydraulic hoses and fittings for leakage.

A shortage of hydraulic oil can cause hydraulic system breakdown and damage to major mechanical parts due to overheating.



ELECTRICAL

⚠ WARNING: Baileigh Industrial Holdings LLC is not responsible for any damage caused by wiring up to an alternative 3-phase power source other than direct 3-phase. If you are using an alternate power source, consult a certified electrician or contact Baileigh Industrial Holdings LLC prior to energizing the machine.

⚠ CAUTION: HAVE ELECTRICAL UTILITIES CONNECTED TO MACHINE BY A CERTIFIED ELECTRICIAN!
Check if the available power supply is the same as listed on the machine nameplate.

⚠ WARNING: Make sure the grounding wire (green) is properly connected to avoid electric shock. DO NOT switch the position of the green grounding wire if any electrical plug wires are switched during hookup.

Power Specifications

Your machine is wired for 220 volts, 60hz alternating current. Before connecting the machine to the power source, make sure the power source is OFF.

Before switching on the power, you must check the voltage and frequency of the power to see if they meet with the requirement, the allowed range for the voltage is $\pm 5\%$, and for the frequency is $\pm 1\%$.

Considerations

- Observe local electrical codes when connecting the machine.
- The circuit should be protected with a time delay fuse or circuit breaker with an amperage rating slightly higher than the full load current of machine.
- A separate electrical circuit should be used for your machines. Before connecting the motor to the power line, make sure the switch is in the "OFF" position and be sure that the electric current is of the same characteristics as indicated on the machine.
- All line connections should make good contact. Running on low voltage will damage the motor.
- In the event of a malfunction or breakdown, grounding provides a path of least resistance for electric current to reduce the risk of electric shock. This machine is equipped with an electric cord having an equipment-grounding conductor and a grounding plug. The plug must be plugged into a matching outlet that is properly installed and grounded in accordance with all local codes and ordinances.



⚠ WARNING: In all cases, make certain the receptacle in question is properly grounded. If you are not sure, have a qualified electrician check the receptacle.

- Improper connection of the equipment-grounding conductor can result in risk of electric shock. The conductor with insulation having an outer surface that is green with or without yellow stripes is the equipment-grounding conductor. If repair or replacement of the electric cord or plug is necessary, do not connect the equipment-grounding conductor to a live terminal.
- Check with qualified electrician or service personnel if the grounding instructions are not completely understood, or if in doubt as to whether the machine is properly grounded.
- Repair or replace damaged or worn cord immediately.

Power Supply

The three-phase system is adopted. The machine is supplied with power of 60HZ and AC220V. The control transformer TC1 supplies the power of AC24V and AC220V to the control circuit. A rectifier is used to supply the power of DC24V to the solenoid valves.

To guarantee the safety of you and you equipment, the machine must be connected with the earthen grid by the cable whose section is as same as that of the main supply cable. It is recommended to make an earth device especially for the machine.

Power Supply Environment

Ambient Temperature: 5--40°C

Ambient Humidity: 35-95%, no frost

Altitude: below 1000m

Illumination: 500 LUX

Installation environment: no poisonous air; no metal fragment.



Power cord connection:

1. Unlock and open the electrical enclosure door.
2. Insert a strain relief fitting into an open hole at the bottom of the electrical cabinet to grip the power cord (supplied by customer) and route a power cord into the cabinet to the top of the terminal strip at the upper right side of the cabinet (XT1).
3. Connect the three power wires terminals L1, L2, & L3. Connect the ground wire (typically green) to the PE terminal.
4. Check that the power cord is routed inside the cabinet so as to avoid contact with other components inside the cabinet.

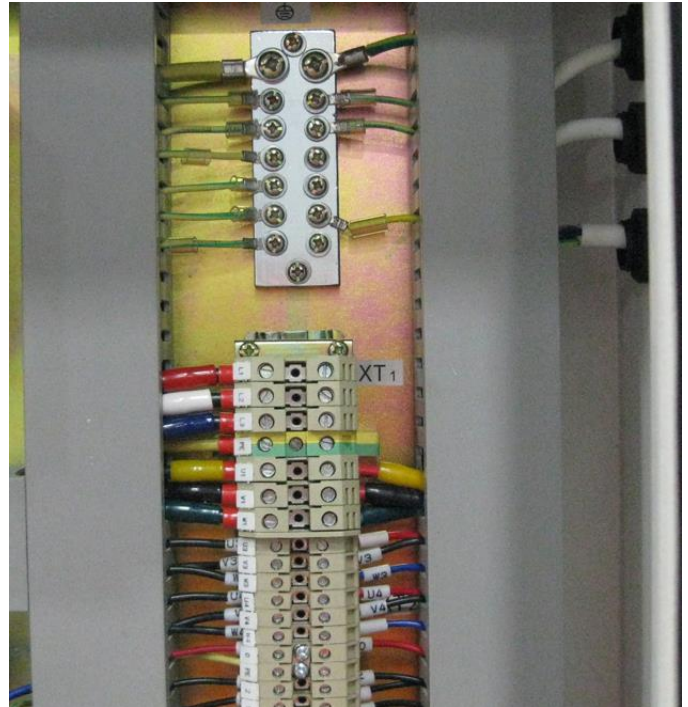

Check for correct rotation of the motor

1. Close the electrical enclosure door.
2. With power connected and the main disconnect turned ON, the power light on the control panel will be lit.
3. Release both emergency stop buttons and place the key selector switch in the Hand position.
4. Verify that all guards, doors, and panels are closed and locked to engage their safety switches.
5. Press and hold the green power button until the hydraulic pump comes up to full rpm. If the green lamp turns off and the pump stops, recheck that all of the safety switches are fully closed and engaged.
6. On the control pedant, press the green start button.
7. Press the up or down pedal to raise (normal at installation) or lower the ram. The ram should move in the direction selected.
8. If not, stop the machine and disconnect power to the machine.
9. Switch the L1 and L3 wires and retest operation. DO NOT move the ground wire.



ELECTRICAL SYSTEM OPERATION

⚠ CAUTION: Always wear proper eye protection with side shields, safety footwear, and leather gloves to protect from burrs and sharp edges.

⚠ CAUTION: Keep hands and fingers clear of the ram. Stand off to the side of the machine to avoid getting hit with the bending material as it is being bent. When handling large heavy materials make sure they are properly supported.

Switch and Button Functions

⚠ WARNING: Before making adjustment to or servicing this machine, turn the main disconnect switch “OFF”. Also turn off and Lock Out the electrical supply source to this machine. **FAILURE TO FOLLOW THESE INSTRUCTIONS MAY RESULT IN FATAL OR SERIOUS INJURY.**

MAIN DISCONNECT SWITCH – The safety disconnect switch turns power on to the machine when in the “ON” position. The power indicator lamp (A) will be illuminated.

POWER INDICATOR LIGHT – The white indicator lamp (A) will be illuminated when the machine is properly powered ON.

POWER KEY SWITCH – The key switch (B) controls the power to the operating system of the machine. When turned to the ON position the controller will be powered On. The controller will control the back-gauge setting, punch depth setting, and provide a piece count. The controller may then be used to set the back-gauge and punch depth settings. The main disconnect must be turned ON.

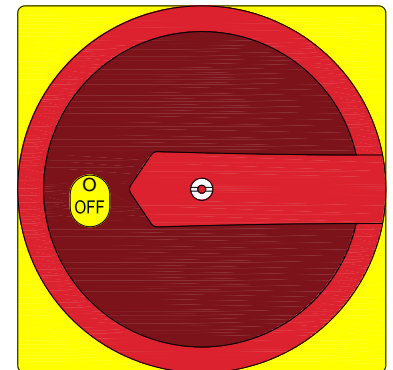

PUMP START PUSHBUTTON – When the system is properly set, (doors and guards closed and latched) depressing the pump start button (C) will start and run the main motor. The green light on the pump start button will be lit. The main motor must be running before the controller will allow for programming and setting of the X and Y axis's.

PUMP STOP / RESET PUSHBUTTON – When operation is interrupted due to a safety limit switch activation, the system will be locked out until the limit switch is satisfied (door or guard closed) and the Reset button (D) is pressed. This clears the system to return to normal operation.



CYCLE MODE SELECTOR SWITCH –

The Cycle Mode Selector switch (E) is a 2-position switch which allows you to pick one of two bend modes.

Inch-stroke operation mode

- In the left “inch” mode, the die will move down or up when the foot pedal is pressed and stop when the foot pedal is released. Inch mode is typically used during setup and testing.
- Step on and hold the down foot pedal; the ram starts downward movement at approach speed until the shift point limit switch (located on the left side of the ram) is contacted. Continue to hold the down foot pedal as the ram changes to work speed. The ram will complete the cycle until it reaches the BDP point. The pressure increases to the limited value and remains at the BDP until the up foot pedal is pressed. Press the up foot pedal to raise the ram to the TDP point.
- During Inch stroke cycle, when the foot pedal is released, the ram will stop and stay at the position stopped at.



Single-stroke operation mode

- In the right “semi-auto” mode, the ram will continue to cycle down and up based upon the program settings in the YSD6000D controller and the operation of the foot pedal.
The ram will start automatically and pause based on time delay settings and stop when the total number of piece parts have been completed. Semi-Auto mode is typically used to bend parts after setup whether in Single or Programmed operation.
- Step on and hold the down foot pedal through the entire bend cycle. The ram starts downward movement at approach speed until the shift point limit switch (located on the left side of the ram) is contacted. Continue to hold the down foot pedal as the ram changes to work speed. The ram will complete the cycle until it reaches the BDP point. The pressure increases to the limited value, and ram returns to the TDP point automatically and stops.



Release the foot pedal and begin a new cycle when ready or continue to hold the foot pedal down and the next cycle will begin after the programmed time delay.

- During the Single stroke cycle, the ram will stop and return up if the pedal is released before the shift point limit switch is activated. Once the shift point limit switch is activated, if the foot pedal is released, the ram will stop and stay at the position it stopped at. Press the down pedal again to resume. Once the pressure setting is reached and relieved, the pedal may be released. The ram will return to the TDP point when the timer has completed its cycle.

Alternatively, switch the Cycle Mode Selector switch to the Inch position and press the Up pedal to raise the ram to the TDP point.

E-STOP BUTTON – Emergency stop buttons are located at the control station (F) and top of the foot pedal control station. When pressed, the red **E-STOP** button will stop all machine functions. Clear and correct the condition for which the emergency stop was pressed before resetting the emergency stop and continuing forward. Turn button clockwise (**cw**) to reset.

System Safety

The Safety interlock System consists of five switches used to ensure that the guards are closed and latched and that the operator has checked and reset both emergency stop switches. If any one of the switches is activated, the hydraulic pump will not start, or if running, the hydraulic pump will stop. This will stop all other functions until the activation is cleared and the switch returned to the operating position.

CONTROL PRINCIPLE OF YSD6000D

Controls of Mechanical Stop Adjust (Y-Axis) and Back Gauge (X-Axis)

- The adjustment of the axis is performed only with the machine stopped at the TDP point.
- The mechanical stop for the punch depth (Y-axis) and the back gauge (X-axis) are controlled by "YSD6000D" numerical control system. The axis motors are servo controlled to provide high accuracy and repeatability.
- When the Y-axis is activated, power is supplied to the servo driver which in turn signals the Y-axis motor to move at the full speed to drive the axis to the set destination. As the axis nears the set point, the speed is reduced. This slows the motor speed and the inertia of movement to allow the Y-axis to reach the target value accurately.
- When the X-axis is activated, power is supplied to the servo driver which in turn signals the X-axis motor to move at the full speed to drive the axis to the set destination. As the axis nears the set point, the speed is reduced. This slows the motor speed and the inertia of movement to allow the X-axis to reach the target value accurately.
- When both axes are programmed to move to a new set point, the Y-axis will move first and then the X-axis.



OPERATION INSTRUCTION, YSD6000D

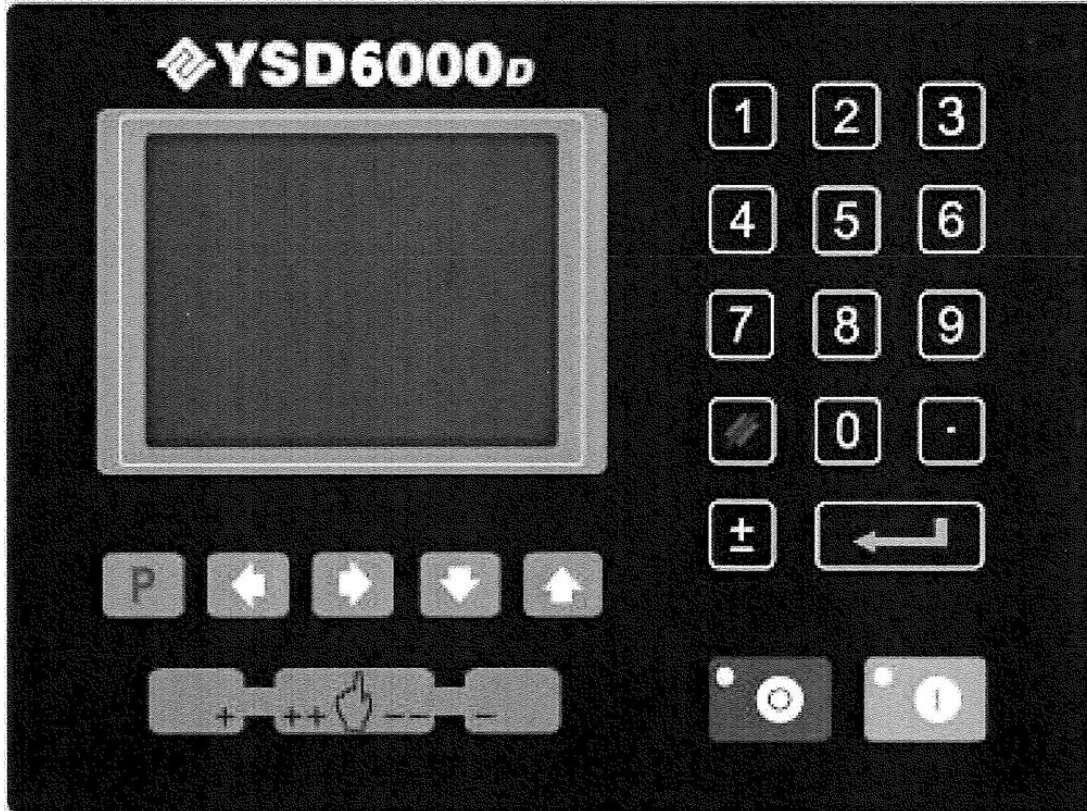

Keys



Clear/Delete key, clear current data entered.



Enter: in programming interface, press this key to confirm the parameter entered and switch between X, Y, and other operator settable parameters; in parameter interface, press this key to confirm the parameter entered.



Stop, Stops operation and the LED in the corner will illuminate.



Start, to let the controller operate in the automatic running interface. The LED in the corner will illuminate when running. This button must be pressed and On (LED illuminated) for the press to cycle down and up.



Interface switching, mainly used to switch among parameter interface, programming interface and diagnose interface and to modify in program sequence.



Left Direction key, moves the cursor to the left or page back.



Right Direction key, moves the cursor right or page forward.



Cursor up, press this key to show previous parameter.



Cursor down, press this key to show next parameter.



Symbol Key. Press this key to switch the symbol of value in the input area between + (positive) and – (negative).



0 – 9 Digit Keys. The 10 digit key pad.



Decimal key. This key allows you to input decimal symbol.



Low speed forward moving key.



Low speed forward moving key.



High/low speed selection, press this key to output high speed and release to output low speed key.

Display Screen

The display screen is a 160 x 160 dot matrix LCD display.

- Title bar: display relevant information of current page, such as its name, etc.
- Parameter display area: display parameter name, parameter value and system information.
- Status bar: display area of input information and prompt message, etc.

SINGLE			
X=	12.000	Y=	2.500
XP =	12.000	YP =	2.500
DX =	0.078	HT =	2.00
DLY=	2.00	PP =	0
CP =	22	OPN=	0.000
33			Unit: inch



MACHINE OPERATION

⚠ CAUTION: Always wear proper eye protection with side shields, safety footwear, and leather gloves to protect from burrs and sharp edges. When handling large heavy materials make sure they are properly supported. Keep hands and fingers clear of the bending dies. Stand off to the side of the machine to avoid getting hit with the work material while the punch is pressing the material into the bending die.

Start Up

1. Turn the main disconnect to the ON position. The white power light (A) will be lit.
2. Turn the power key switch (B) to ON when ready to start.
3. Allow the controller display to complete the boot process.
4. Press the pump start button (C). The green power light will be lit.
5. Start completed.

Shutdown

1. Turn Selector Switch (E) to the INCH (left) position and press the down foot pedal to lower the ram to the bottom of the stroke or until it just makes contact with the lower die.
2. Turn the power key switch (B) to OFF and remove the key.
3. Turn the main disconnect to OFF to shutdown the controller.

Emergency Stop Button

1. In the event of incorrect operation or dangerous conditions, the machine can be stopped immediately by pressing the **E-STOP** button.
2. Twist the emergency stop button clockwise (cw) to reset.



Note: Resetting the E-Stop will not start the machine.

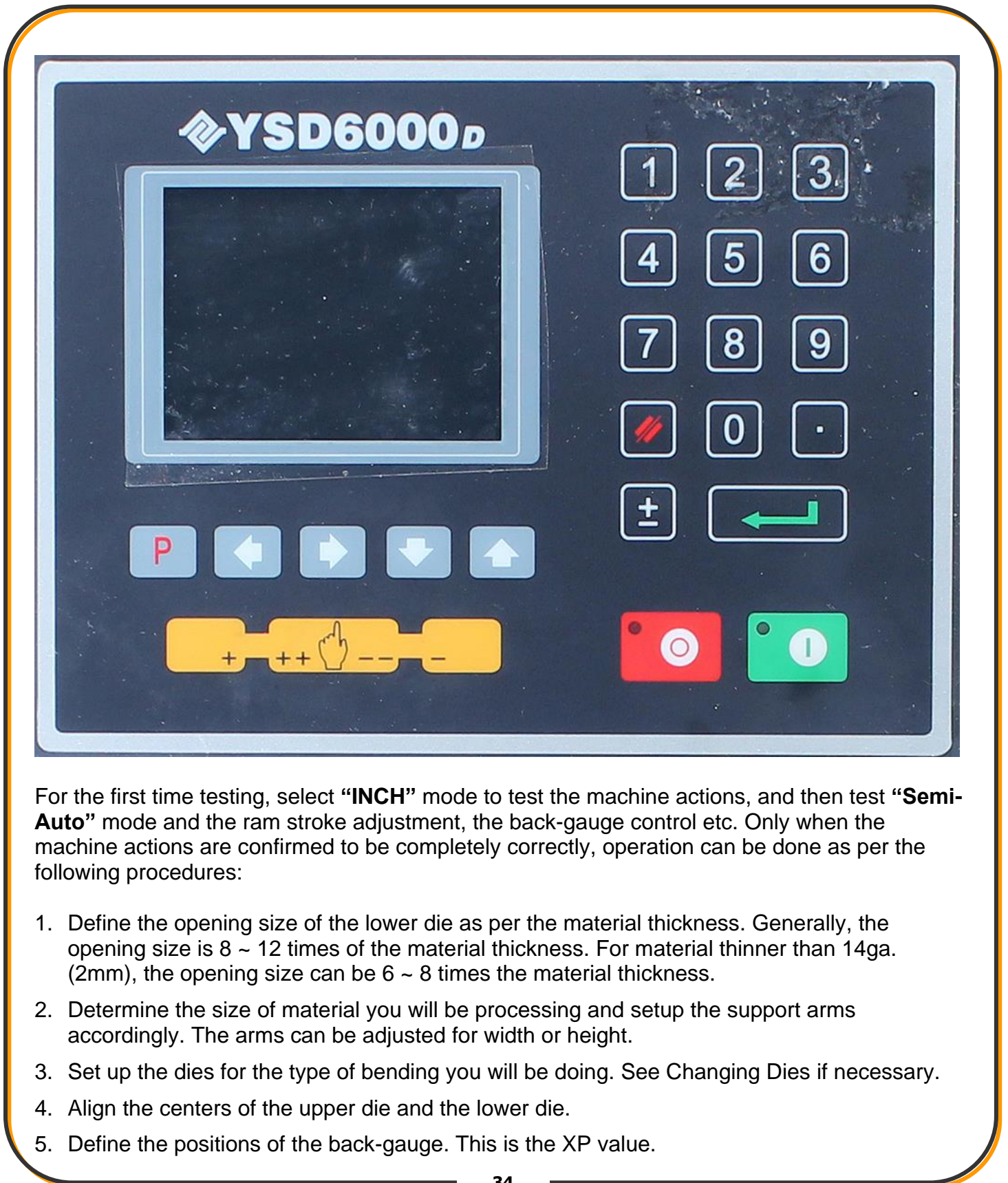

For the first time testing, select “INCH” mode to test the machine actions, and then test “Semi-Auto” mode and the ram stroke adjustment, the back-gauge control etc. Only when the machine actions are confirmed to be completely correctly, operation can be done as per the following procedures:

1. Define the opening size of the lower die as per the material thickness. Generally, the opening size is 8 ~ 12 times of the material thickness. For material thinner than 14ga. (2mm), the opening size can be 6 ~ 8 times the material thickness.
2. Determine the size of material you will be processing and setup the support arms accordingly. The arms can be adjusted for width or height.
3. Set up the dies for the type of bending you will be doing. See Changing Dies if necessary.
4. Align the centers of the upper die and the lower die.
5. Define the positions of the back-gauge. This is the XP value.



6. Define the lower limit position of the rams. This is the YP value.
7. Adjust the limit switch ramps for the travel limit switches so that the distance between the upper die and lower die is only slightly more than the thickness of the material being run. Doing so will reduce the chance of a foreign object getting between the dies and provide a faster cycle time when doing production work.
8. Ensure normal and standard "Inch" and "Semi-Auto" operation.

 **WARNING: IF A HAND OR OBJECT BREAKS THE SAFETY BEAM AFTER THE CYCLE HAS BEEN STARTED THE RAM WILL STOP UNTIL THE OBJECT IS CLEARED.**

9. Position the safety light curtain sensors in front of the die opening so that if any part of the body should enter the die area during a bend, the bend will stop until the area is cleared. You should notice the red scanning code and green light near the bottom of the emitter and a red light on the receiver. If you wave an object through the beam the green light will turn red.
10. Safely start the machine. (The white power light will be lit)
11. Press the green pushbutton to start the hydraulic pump.
12. Press the green key on the "YSD6000D" controller to activate the operating system.
13. Allow the Y and X axes to move to the programmed positions.
14. Place the cycle mode selector switch to the left INCH position and press the DOWN foot pedal. The ram should come down.
15. Press the UP foot pedal to raise the ram back to the top position.
16. Put the test material in the middle part of the worktable for trial bending.
17. Turn the cycle mode selector switch to "Semi-Auto" mode.
18. Press and hold the DOWN foot pedal until down travel block contacts the shift point limit switch or until the ram is at the bottom of the stroke. After the HT (hold time) has expired, the ram will raise and return to the top position and wait for the next command. If the operator continues to hold the down foot pedal, the ram will start the next cycle automatically. There will be approximately a 3 – 4 second delay before this next cycle begins.



PROGRAMMING

This device has two programming methods, which are single-step programming and multi-step programming. The user can set up programming according to actual demand.

At start up, the control screen will display the “Single” mode programming screen.

Pressing the  key will toggle between the three main programming screens.

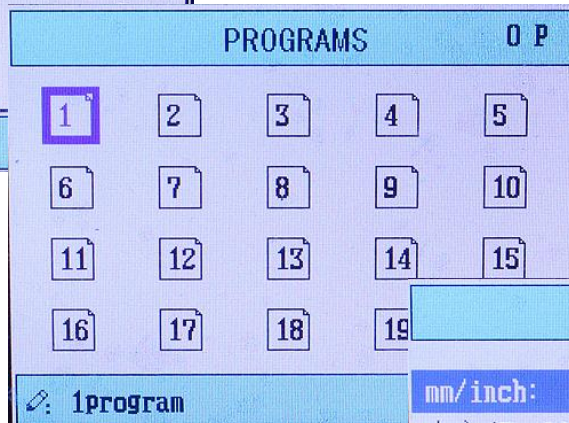
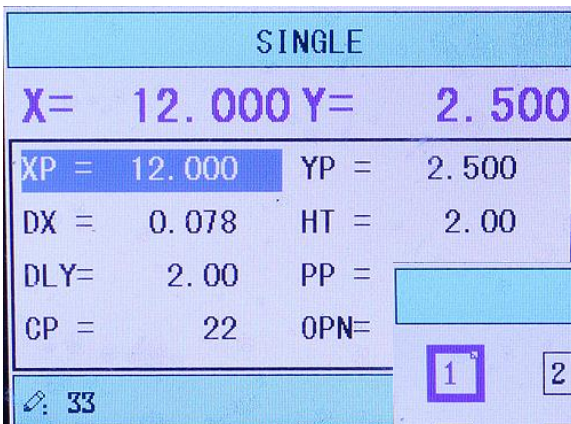

The Single screen may be programmed directly to complete a single parameter bend. See the steps to follow.

The “Programs” screen is used to program multi-step bends. Each step is programmed similar to the single bend, however they are grouped together into one program that has many different bend settings. See the steps to follow.

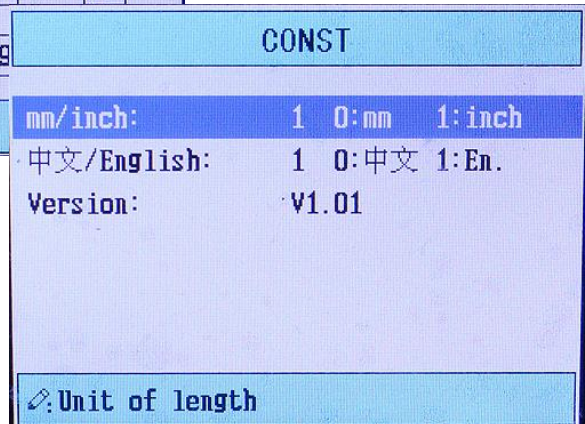

The “CONST” screen is a reference screen. DO NOT make changes on this screen. This is also an access screen to deeper parameter settings.



Bending Operation

NOTICE: This machine is designed for balanced operation. That means that the material should be evenly positioned between the dies from the center out. Loading material on one end of the machine will cause excessive loading on one ram and slide. This will shorten the life of the components and possibly damage the machine frame beyond repair. If biased loading is absolutely necessary on one end, place a similar material on the other end to prevent the biased loading problem. This is NOT covered by warranty.

Single Bend

Single bend operation is simplest most basic operation. The single refers to the dimension/settings to be used for the bend. A single set of dimensions will be used until changed by the operator. Whether the work piece has one bend or several, each bend is completed using the same single set of dimensions.

The following items may be programmed into the controller on this screen to be used for Single

bending.



Note: Parameter can only be set when Stop indicator is on.

XP	Back Gauge dimension. 0.314" (forward) – 23.62" (back) = Is measured from the center line of the V groove being used, to the tip of the stop block. The smallest value that may be programmed in for this setting is 0.314
YP	Depth the Ram will travel down. 0.039" (Ram is have no downward travel – 3.10" (Ram will have the maximum downward travel) = Is a relative number which in general is based upon maximum travel having the Punch tip (as included) being at the center of the Die (as included). The largest value that may be programmed in for this setting is 3.10".
DX	The is a distance value that may be programmed to have the back gauge move away (retract) from the work piece at the moment the punch is about to touch the work piece.
HT	This is a time value that starts when the down travel contact block activates the shift point limit switch. This value must be long enough for the ram to reach the full down stroke and cause the hydraulic system to reach pressure relief for at least 0.1 second.
DLY	The is a time value that may be programmed to have the back gauge move away (retract) from the work piece at the moment the punch is about to touch the work piece.
PP	This value is the Programmed Piece count desired for the job to be run.
CP	This value is the Counted Pieces of the bends completed.
	The bottom line of the screen (pencil  symbol) will display the parameter limits when the parameter is highlighted. When a value is entered, that value will display until the Enter key or Cancel key is pressed.



Set up range of single step parameter

Parameter	Unit	Set Up Range	Remarks
X	inch	-	Current position of X axis, unable to be modified.
Y	inch	-	Current position of Y axis, unable to be modified.
XP	inch	0.314 – 23.62	Program position of X axis.
YP	inch	0.039 – 3.10	Target position of Y axis.
DX	inch	0.000 – 10.000	Retract distance of X axis.
HT	sec	0-9999s	The time between down travel limit switch being engaged and end hold time output.
DLY	sec	0-9999s	Delay Time for X axis retract and return movement.
PP	-	0-9999	Number of preset work piece.
CP	-	0-9999	Number of current work piece.

Single Step

If there is a piece of material which needs to be processed into workpieces with same length as noted in the following:

- Length of each workpiece is 12.00"
- Depth of Bend (Y) is 2.500"
- Distance of retracting is 0.078"
- Time for the back gauge retract delay is 2.00sec.
- Workpiece is 10.





1. Start the press and allow the controller to boot up.
2. Start the hydraulic pump.
3. The "Single" screen will appear with the "XP" line highlighted. This line is the "PROGRAMMED" position of the back-gauge, (X axis).
4. Enter the value desired (12.00) of the position of the back-gauge (XP). This value will be displayed in the bottom line of the screen. This is the line with

the pencil  symbol.

5. Press the  Enter key. This will enter the value into the XP line and move the highlight to the next line. The YP line.

SINGLE			
X=	12.000	Y=	2.500
XP =	12.000	YP =	2.500
DX =	0.078	HT =	2.00
DLY=	2.00	PP =	0
CP =	22	OPN=	0.000
33		Unit: inch	



6. Enter the value desired (2.5) of the position of the depth of bend (YP). This value will be displayed in the bottom line of the screen.
7. Press the  Enter key. This will enter the value into the YP line and move the highlight to the next line. The DX line.
8. Enter the value desired (0.078) for the back-gauge to retract away from the work piece (DX). 0 (zero) will keep the back gauge in position for the entire bend. This value will be displayed in the bottom line of the screen.
9. Press the  Enter key. This will enter the value into the DX line and move the highlight to the next line. The HT line.
10. Enter the value needed (2.00) for the Hold Time (HT). Generally, start with a value of 1.5 – 2.0 seconds and fine tune the number with experience for the specific bend and material. This value will be displayed in the bottom line of the screen. This is a time value that starts when the down travel contact block activates the shift point limit switch. This value must be long enough for the ram to reach the full down stroke and cause the hydraulic system to reach pressure relief for at least 0.1 second.
11. Press the  Enter key. This will enter the value into the HT line and move the highlight to the next line. The DLY line.
12. Enter the value, if needed, (2.0) for a delay to occur before the back-gauge will retract away from the work piece. This will allow the punch to move deeper into the bend before the back-gauge move back away from the work piece. This value will be displayed in the bottom line of the screen.
13. Press the  Enter key. This will enter the value into the DLY line and move the highlight to the next line. The PP line.
14. Enter the value for the number of parts (10) desired (PP). Enter 0 (zero) if no piece count is needed. This number could be the number of pieces for the complete job, or how many parts fit in a container, or some other value that creates a counting point. When this value is reached during operation, the controller will automatically switch from the Run to Stop. Press the green Start/Run key to reset the count and count the next set of parts. This value will be displayed in the bottom line of the screen.
15. Press the  Enter key. This will enter the value into the PP line and move the highlight to the next line. The CP line.
16. Enter 0 (zero) to clear the bend count if the PP line is 0 (zero). If the PP has a programmed value, do not change this line. This value will be displayed in the bottom line of the screen.
 - a. The CP line is a bend counter line. If 0 (zero) is entered for the PP value, the CP line will continue to count each bend cycle as one bend. If the PP line has a value, the CP number will count down from the programmed value to 0 (zero) to complete the counted parts.



17. Press the  Enter key. This will enter the value into the CP line and move the highlight to the next line. The XP line.

18. Place the Mode key switch in the semi-auto (right) position.

19. Press the  Start/Run key to enter the operational page. This activates the system to allow for operation.

- a. The system will activate the setting that have just been entered. This means that the Y and X axis's will move to the programmed locations. Y will move first and then X.
- b. When the Y and X axis's have finished moving to the programmed positions, the system is ready for a bend operation. If no change was programmed into either the Y and X axis's, the system is ready for a bend operation.

20. Place the work piece into the dies and up to the back-gauge.

21. Plan for the swing of the work piece during the bend.

- a. **DO NOT** hold the work piece in an area that may become a pinch point.
- b. **DO NOT** stand in an area that will strike the operator or bystanders during the bend cycle.

22. When the die area and work piece swing area are clear, press and hold the Down foot pedal to complete the bend.

- a. The foot pedal may be released when the ram is lowered enough to engage the shift point limit switch. If the foot pedal is released before the shift point limit switch is engaged, the ram movement will stop. Press the Up pedal to lift the ram and start again.

23. After a short pause based upon the HT time. The ram will raise back to the up position and wait until the next bend command from the foot pedal.

24. A Single bend has been completed.





Multi-Step Programming

Multi-step program is used for processing single work piece of different processing steps, realize consecutive implementation of multi-steps, and improve processing efficiency.

The following items may be programmed into the controller on this screen to be used for Multi Stage bending.

Multi-Step Parameter Setting Screen 1

Parameter	Unit	Setting Range	Remarks
ST	-	0 ~ 25	Stations. Set up total processing step number of this program
PP	-	0 ~ 99999	Number of preset work piece.
CP	-	0 ~ 99999	Number of current work piece. The CP line is a bend counter line. If 0 (zero) is entered for the PP value, the CP line will continue to count each bend cycle as one bend. If the PP line has a value, the CP number will count down from the programmed value to 0 (zero) to complete the counted parts.
DLY	ms	0 ~ 99999ms	Delay Time for X axis retract and return movement.
HT	ms	0 ~ 99999ms	The time between down travel limit switch being engaged and end hold time output.

Multi-Step Parameter Setting Screen 2

The Screen 2 information will be repeated for each ST (process step). Example; If 3 is entered into the ST parameter, this screen will be repeated 3 times. Each screen may have its own X and Y values.

Parameter	Unit	Set Up Range	Remarks
X	inch	-	Current position of X axis, unable to be modified.
Y	inch	-	Current position of Y axis, unable to be modified.
XP	inch	0.310 – 20.000	Program position of X axis.
YP	inch	0.118 – 3.100	Target position of Y axis.
DX	inch	0.000 – 10.000	Retract distance of X axis.
RP	-	1 ~ 99	Repeat Time. This is the number of times the system will repeat this exact same bend settings before moving on to the next station screen.







Multi-Bend Operation Steps

The description of the PROGRAM parameters

Parameter	Default	Range	Unit	Description
ST	0	0-25	-	The total number of steps in this program.
pp	0	0-99999	-	The number of processing workpiece in this program.
CP	0	0-99999	-	PP = 0: This value is the current work piece. PP > 0: This value is the remain work piece.

1. Start the press and allow the controller to boot up.
2. Start the hydraulic pump.
3. The “Single” screen will appear with the “XP” line highlighted.

4. Press the  button to switch to Program manage screen.

5. Press either the , , , or  arrow keys to select the program number, or input program number directly, such as input "1", or "20".

6. Press the  enter button to enter the multi-step program setting screen.

7. The “Program2” screen will appear with the “ST” line highlighted.

8. Enter the value desired for the number of Stations (ST) needed to complete the operation. This value will be displayed in the bottom line of the screen.

This is the line with the pencil  symbol.



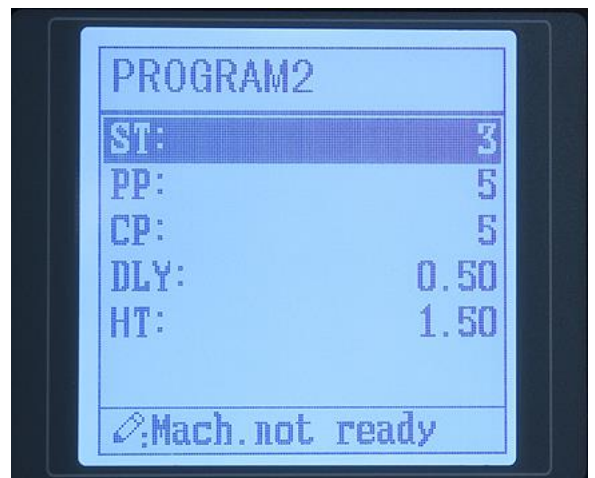
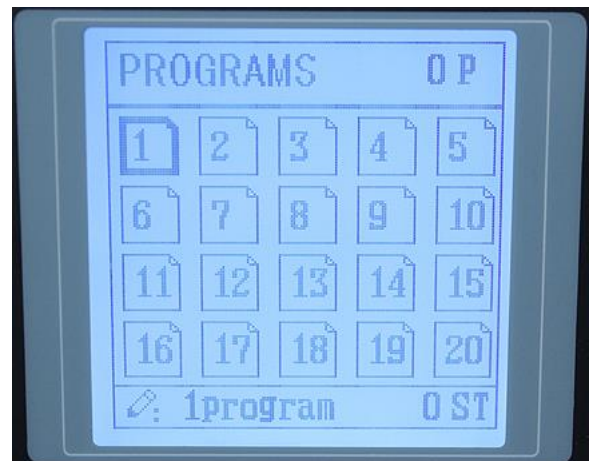

9. Press the  Enter key. This will enter the value into the ST line and move the highlight to the next line. The PP line.

10. Enter the value for the number of parts desired (PP). Enter 0 (zero) if no piece count is needed. This number could be the number of pieces for the complete job, or how many parts fit in a container, or some other value that creates a counting point. When this value is reached during operation, the









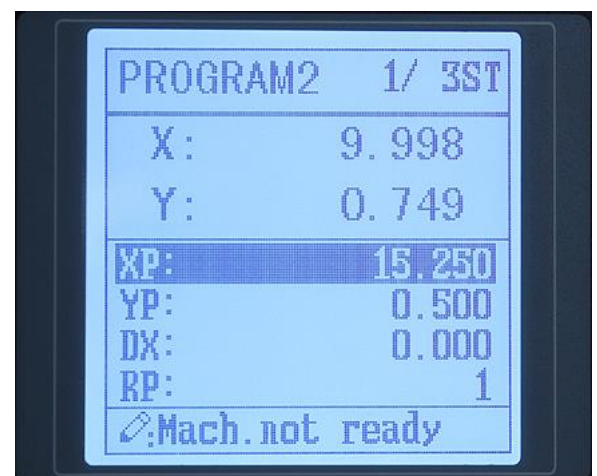



controller will automatically switch from the Run to Stop. Press the green Start/Run key to reset the count and count the next set of parts. This value will be displayed in the bottom line of the screen.

11. Press the  Enter key. This will enter the value into the PP line and move the highlight to the next line. The CP line.
12. Enter 0 (zero) to clear the bend count if the PP line is 0 (zero). If the PP has a programmed value, do not change this line. This value will be displayed in the bottom line of the screen.
 - a. The CP line is a bend counter line. If 0 (zero) is entered for the PP value, the CP line will continue to count each bend cycle as one bend. If the PP line has a value, the CP number will count down from the programmed value to 0 (zero) to complete the counted parts.
13. Press the  Enter key. This will enter the value if any into the CP line and move the highlight to the next line. The DLY line.
14. Enter the value, if needed, for a delay to occur before the back-gauge will retract away from the work piece. This will allow the punch to move deeper into the bend before the back-gauge move back away from the work piece. This value will be displayed in the bottom line of the screen.
15. Press the  Enter key. This will enter the value into the DLY line and move the highlight to the next line. The HT line.
16. Enter the value needed for the Hold Time (HT). Generally, start with a value of 1.5 seconds and fine tune the number with experience for the specific bend and material. This value will be displayed in the bottom line of the screen.
17. Press the  Enter key. This will enter the value into the HT line and move the highlight to the next line. The ST line.
18. When the setup is complete, press the  right arrow key to enter the step parameter setup screen. This will allow for setting the parameters for the first station.
19. Pay attention to the sequence of the step labeling.
1 / 3ST: 1 indicates the current step, 3 indicates the total step. The machine will run in sequence.
20. The "Program2 1/ 3ST" screen will appear with the "XP" line highlighted. This line is the "PROGRAMMED" position of the back-gauge, (X axis).





21. Enter the value desired of the position of the back-gauge (XP). This value will be displayed in the bottom line of the screen. This is the line with the pencil  symbol.
22. Press the  Enter key. This will enter the value into the XP line and move the highlight to the next line. The YP line.
23. Enter the value desired of the position of the depth of bend (YP). This value will be displayed in the bottom line of the screen.
24. Press the  Enter key. This will enter the value into the YP line and move the highlight to the next line. The DX line.
25. Enter the value desired for the back-gauge to retract away from the work piece (DX). 0 (zero) will keep the back gauge in position for the entire bend. This value will be displayed in the bottom line of the screen.
26. Press the  Enter key. This will enter the value into the DX line and move the highlight to the next line. The RP line.
27. Enter the value needed for the Repeat Times (RP). This is how many times the system will perform the bend operation using the same setting on the same station screen before moving to the next station screen which will typically have at least one different setting. This value will be displayed in the bottom line of the screen.
28. Press the  Enter key. This will enter the value into the RP line and move the highlight to the next line. The XP line.
29. When the setup on the 1/ 3ST screen is complete, press the  right arrow key to enter the next station setup screen 2/ 3ST. Repeat the parameter set up for this and each additional station screen.
30. When the last station screen has been programmed, pressing the  right arrow key will change back to the 1st station screen.
31. Place the Mode key switch in the semi-auto (right) position.
32. Press the  Start/Run key to enter the operational page. This activates the system to allow for operation.
 - a. The system will activate the setting that have just been entered. This means that the Y and X axis's will move to the programmed locations. Y will move first and then X.
 - b. When the Y and X axis's have finished moving to the programmed positions, the system is ready for a bend operation. If no change was programmed into either the Y and X axis's, the system is ready for a bend operation.



33. Place the work piece into the dies and up to the back-gauge.

34. Plan for the swing of the work piece during the bend. DO NOT hold the work piece in an area that may become a pinch point. DO NOT stand in an area that will strike the operator or bystanders during the bend cycle.

35. When the die area and work piece swing area are clear, press and hold the Down foot pedal to complete the bend.

- a. The foot pedal may be released when the ram is lowered enough to engage the down travel limit switch. If the foot pedal is released before the down travel limit switch is engaged, the ram movement will stop. Press the Up pedal to lift the ram and start again.

36. After a short pause based upon the HT time. The ram will raise back to the up position and wait until the next bend command from the foot pedal.

37. The RP value will determine if the system remains on this station screen or moves to the next station screen. If the RP: value in the top line of the display = 1/1, or 3/3, or 10/10 then the system will advance to the next station screen. If the first number of the RP line is < the second number, the system will repeat the same bend parameters from the same station screen.

38. When all of the programmed stations have been completed CP number will count down by 1 until it reaches zero. Then the system will automatically stop and wait for operator input.

39. A Multi-bend has been completed.

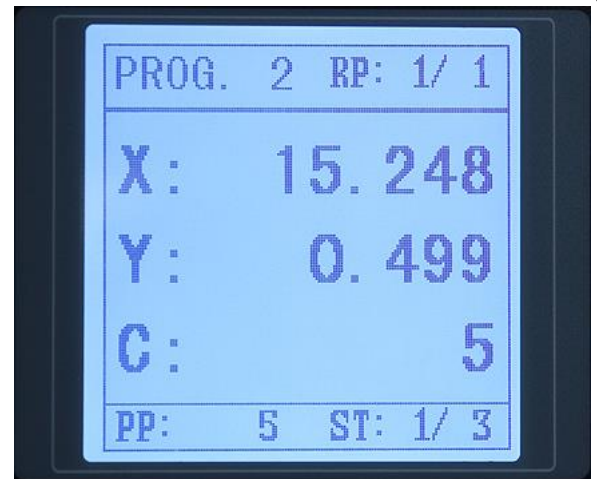



ALARM

The device can detect internal or external abnormalities automatically and send out alarm prompt. The alarm message are available on alarm list.

Operation steps

1. On the CONST page, press the , button to enter IO Monitor page.

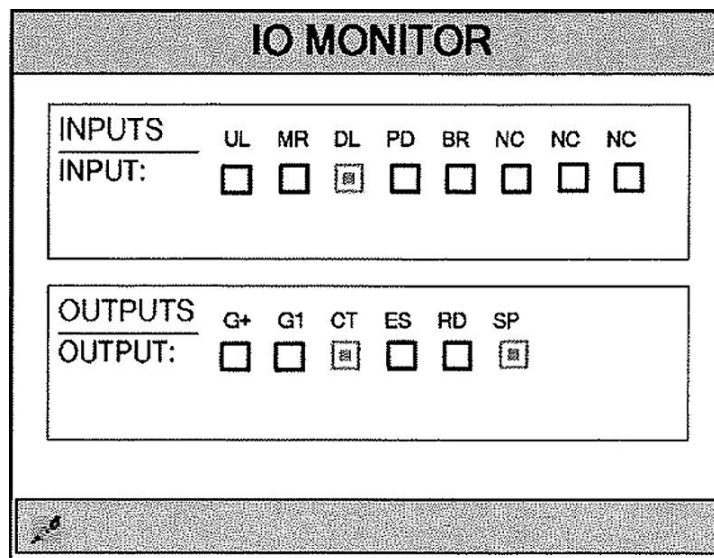

The IO MONITOR screen displays the status of various inputs and outputs. The 'INPUTS' section shows a grid with labels UL, MR, DL, PD, BR, NC, NC, NC and checkboxes below them. The 'OUTPUTS' section shows a grid with labels G+, G1, CT, ES, RD, SP and checkboxes below them. The DL and CT checkboxes are checked.

INPUTS	UL	MR	DL	PD	BR	NC	NC	NC
INPUT:	<input type="checkbox"/>	<input type="checkbox"/>	<input checked="" type="checkbox"/>	<input type="checkbox"/>	<input type="checkbox"/>	<input type="checkbox"/>	<input type="checkbox"/>	<input type="checkbox"/>

OUTPUTS	G+	G1	CT	ES	RD	SP
OUTPUT:	<input type="checkbox"/>	<input type="checkbox"/>	<input checked="" type="checkbox"/>	<input type="checkbox"/>	<input type="checkbox"/>	<input checked="" type="checkbox"/>

2. On the CONST page, press the , arrow button to enter "Alarm Record" page to view all alarm history. The latest 6 alarms, alarm number, and causes can be viewed on this page.

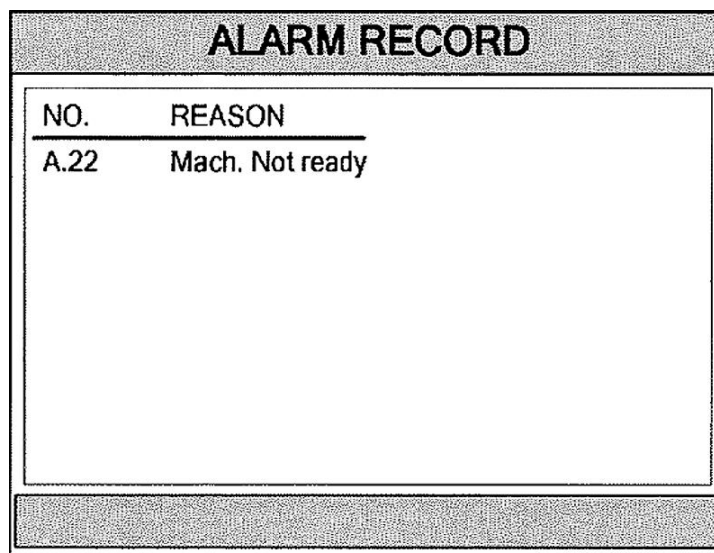





The ALARM RECORD screen displays a table with two columns: NO. and REASON. The first row shows 'A.22' under NO. and 'Mach. Not ready' under REASON.

NO.	REASON
A.22	Mach. Not ready



Alarm Reset

When there is any alarm, the machine stops immediately. If you want to recover the machine's operation, you need to clear the alarm.

On the CONST page, press  arrow button to enter the ALARM RECORD page. The most recent alarm information will display from the top down. Use the information within the edit  dialog box at the bottom of the screen to progress through the problem. Then press the  reset and then  enter button to clear the alarm. The machine is then ready to return to operation.

Monitor

On the CONST page, press the  arrow button to enter IO MONITOR page.

ON the IO MONITOR page, press the  arrow button to enter YV MONITOR page.

Appendix A Common Fault and Troubleshooting

Fault	Troubleshooting
When power on, the device will not display.	The electrode of power supply terminal is connected error; please see the information of power nameplate. Voltage is too low. Electrical outlet is not connected.
When program is operating, motor does not move.	Check whether mechanical part has been locked or slider (ram) returns to Upper Dead Point. Check whether the motor wiring is connected well.
When the device is in multi-step programming, the program cannot change step.	Check U_Limit and EOS terminals are connected to +24V or not.
When the device is in multi-step programming, the program cannot count.	Check U_Limit and EOS terminals are connected to +24V or not.
When programming is operating, the device loses control.	Check whether encoder cable of G-axis is connected or not. Check whether communication cable of X-axis is connected or not. Check whether the motor direction of X-axis and the encoder count direction are correct.
When programming is operating, the device actual position will not display or change.	Check whether encoder wiring is correct or encoder cable is connected well.



Appendix B Alarm List

Alarm NO.	Alarm Information	Alarm Description
A.01	Pieces reached	Normal message, that the count reaches a preset value.
A.02	X Pos <minimum	The current position of X-axis is out of the minimum value, it is necessary to move the X-axis to the soft limit range manually.
A.03	X Pos >maximum	The current position of X-axis is out of the maximum value, it is necessary to move the X-axis to the soft limit range manually.
A.04	G Pos <minimum	The current position of G-axis is out of the minimum value, it is necessary to move the G-axis to the soft limit range manually.
A.05	G Pos >maximum	The current position of G-axis is out of the maximum value, it is necessary to move the G-axis to the soft limit range manually.
A.06	Out of UDP	Move the cutter to the Upper Dead Point by foot switch.
A.08	X Out of limit.	When the X-axis is employed for the front feed, the current position of X-axis is out of the soft limit range. It is necessary to move the X-axis to the soft limit range manually.
A.11	Slider Block (Ram) err.	The slider (ram) is not on the TDC in the case of positioning. Move the ram to the Upper Dead Point by foot switch.
A.12	Finished work	Normal message when the count reaches the preset value. Requires operator to manually clear alarm.
A.22	Mach. Not ready	Need to start the hydraulic pump power.
A.23	Encoder abnor.	The voltage of encoder is abnormal. Check wiring, connections and signal voltage.
A.24	Comm. Err.	Can communication is abnormal, please check whether the communication port ground is well.
A.25	X-axis Dropped	The X-axis driver is missing. Reboot the system and try drive again.
A.27	Can Send Err.	The device is not connected to the drive. Check and connect the drive.
A.29	Safe In Err.	Light signal loss on the BEND stage, check the screen input signal with or without object light signal.
A.30	Power Drop	The system voltage is lower than the normal value, check whether the system voltage is normal.
AX.60- AX.67	CAN Error	The X-axis CAN communication is abnormal, restarting the system after clearing the alarm.



Appendix C Parameter Description

Parameter	Default	Range	Unit	Description
CONST				
mm/inch	0	0-1	-	0: mm 1: inch
Chinese/English	0	0-1	-	0: Chinese 1: English
Version	-	-	-	The current software version number.
TchIn PARA				
X-tea. in	10.00	0-9999.999	mm/inch	When the teaching of X-axis is enabling, the operator assigns to the X-axis of a correct value, to represent the gauge current position.
Y-tea. in	1.00	0-9999.999	mm/inch	When the teaching of Y-axis is enabling, the operator assigns to the Y-axis of a correct value, to represent the gauge current position.
SINGLE				
XP	0.00	-9999.999 ~ 9999.999	mm/inch	Program position of X axle.
Y	0.00	0-99.99	mm/inch	Program position of G axle.
DX	0.00	0-9999.999	mm/inch	Retract distance of X axle.
CL	0	0-100	%	Actual time of the cut length = Max time of the cut length XCL
pp	0	0-9999	-	The number of processing workpiece in this program.
CP	0	0-9999	-	PP=O: this value is the current work piece. PP>O: this value is the remain work piece.
PROGRAM				
ST	0	0-25	-	The total number of steps in this program.
pp	0	0-99999	-	The number of processing workpiece in this program.
CP	0	0-99999	-	PP=O: this value is the current work piece. PP>O: this value is the remain



				work piece.
STEP				
XP	0.00	-9999.999 ~ 9999.999	mm/inch	Program position of X-axis.
Y	0.00	0-99.99	mm/inch	Program position of Y-axis.
DX	0.00	0-9999.999	mm/inch	Retract distance of X axle.
Cut Length	0	0-100	%	Actual time of the cut length = Max time of the cut length XCut Length
Repeat Times	1	1-99	-	The repeat times in this step.



HYDRAULIC SYSTEM INTRODUCTION

This press is an electric over hydraulic operation system (Hydraulic principle scheme); the 2 parallel cylinders drive the ram downward. The torsion shaft ensures synchronization of cylinders. Hydraulic system uses assembling block structure. All hydraulic valves are fixed on the assembling block. It enhances reliability and security of the system, and easy for installation and maintenance.

System analysis:

When machine is in approach speed, electromagnets YA1, YA3 are energized. Valve 7 shifts to left working position and Valve 9 shift to right working position. Oil pump supplies pressure oil to upper part of two cylinders. Because YA3 is energized, the oil in the lower part of two cylinders flow through valve 9, valve 8 and valve 7 then back to the oil tank. The weight of ram makes the downward speed of piston faster than oil supplying speed of oil pump, negative pressure is created in upper part of cylinder. The hydraulic oil in the oil tank drops into the upper part of cylinder through the valve 13. The ram is in the approach speed.

When the ram reaches BSP (signal sent by stroke switch), YA3 is energized. Valve 9 shifts to left working position. The oil in the lower part of cylinder flows through valve 11 and creates 100 bar pressure. The negative pressure in the upper part of cylinder disappears. Valve 13 auto-closes. The hydraulic oil in the oil tank drops into the upper part of cylinder through the valve 7, 8. The ram is in the working speed.

When the ram reaches BDP (signal sent by pressure gauge), YA1 is de-energized, and YA2 is energized. Valve 7 shifts to right working position. Oil pump supplies pressure oil to lower part of two cylinders through valves 7, 8, and 9. The oil in the upper part of cylinder is back to tank through valve 13, and then ram returns. When the ram reaches TDP (signal sent by stroke switch), YA2 is de-energized. Valve 7 is back to the middle working position, ram stops at TDP.

Hydraulic Oil

The hydraulic oil is the primary medium for transmitting pressure and also must lubricate the running parts of the pump.

After installation of the machine and before machine startup, bring the oil level up to 90% of capacity. **A shortage of hydraulic oil can cause hydraulic system breakdown and damage to major mechanical parts due to overheating.**

- Use hydraulic oil SHELL BRAND #68 or an equivalent with similar specifications.
- Keep hydraulic reservoir filled to 90% of capacity.
- **DO NOT** rely totally on the oil gauge as they can sometimes indicate an incorrect level reading. Do a visual inspection with the oil fill cap removed as well.



- A shortage of hydraulic oil will cause hydraulic system breakdown to major mechanical components due to overheating.
- Change the hydraulic oil every 6 months along with the oil filter.

Replacing Hydraulic Oil

The cleaning of the oil tank is very important. Proper hydraulic operation depends upon clean hydraulic oil and a clean hydraulic system.



Important: Used oil products must be disposed of in a proper manner following your local regulations.

1. To drain the hydraulic tank, first make sure the drain valve is closed.
2. Remove the plug and connect a drain hose. Route the drain hose into an approved container for proper disposal.
3. Open the valve to drain the tank. Capacity of the oil tank is approximately 29 gallons (110 liters).
4. Clean the tank by removing the oil tank cover and using a lint free cloth to wipe the inside of the oil tank.
5. When the tank is clean and dry, replace the tank cover.
6. Fill the tank to 90% full through the breather cap port.



} Range of oil

Oil gauge



PRESSURE ADJUSTMENT

The working pressure of hydraulic system can adjust between zero and Maximum Pressure. First determine the bending pressure according to the bending condition, and then determine the needed pressure of hydraulic system.

Calculation Formula

The required bending force can be computed from the following formula:

$$P = (1.42 \times L \times \sigma_b \times S^2) / (1000 \times V)$$

P: = Load (kN)

L: = Bending length (mrn)

σ_b : = Tensile Strength (N/mm²)

S: = Sheet Thickness (mrn)

V: = Width of Opening (mrn)

1Kgf \approx 10N

1MPa \approx 10Bar

1t \approx 10000N=10kN

Example 1:

Nominal Force Pf = 1350kN

Maximum Force Py = 33.5Mpa

Sheet Thickness S = 2mm

Sheet Length L = 3000mrn

Opening V = 8 x S = 8 x 2 = 16mrn

Tensile Strength σ_b = 450N/mm²

Needed bending force:

$$F1 = (1.42 \times 3000 \times 450 \times 2^2) / (1000 \times 16) = 480\text{kN}$$

In practice this value must be increased by 10%.

$$F2 = F1 + F1 \times 10\% = 480 + 480 \times 10\% = 528\text{kN}$$

The needed force of hydraulic system:

$$P = (Py \times F2) / Pf = (33.5 \times 528) / 1350 \approx 13\text{MPa}$$



Determine Bending Force with Bending Chart

For easy computing, we draw a chart with thickness, opening and bending force. When the value σ_b is 450N/mm^2 , the bending force per meter, unit in kN, is equal with calculated value. When the value σ_b is not 450N/mm^2 , search the relevant modulus C, then multiplied by the bending force that checked before, the result is the needed bending force.

Example 2:

Nominal Force $P_f = 1350\text{kN}$

Maximum Force $P_y = 33.5\text{Mpa}$

Sheet Thickness $S = 2\text{mm}$

Sheet Length $L = 3000\text{mm} = 3\text{m}$

Opening $V = 8 \times S = 8 \times 2 = 16\text{mm}$

Tensile Strength $\sigma_b = 600\text{N/mm}^2$

Check the chart. When σ_b is 450N/mm^2 , the thickness $S = 2\text{mm}$, opening $V = 16\text{mm}$, two volumes' crossing grid is the needed bending force per meter, $F_3 = 160\text{kN}$.

Then check the function chart, when σ_b is 600N/mm^2 , $C = 1.35$.

Needed bending force:

$$F_1 = F_3 \times C \times L = 160 \times 1.35 \times 3 = 648\text{kN}$$

In practice this value must be increased by 10%.

$$F_2 = F_1 + F_1 \times 10\% = 648 + 648 \times 10\% \approx 713\text{kN}$$

The needed force of hydraulic system:

$$P = (P_y \times F_2) / P_f = (33.5 \times 713) / 1350 \approx 17.5\text{MPa}$$

(F_1 - compute bending force; F_2 - actual bending force; F_3 - check bending force in the chart; P - needed force of hydraulic system)

For easy computing, when you get bending force, you can check the needed force P from the pressure conversion mark. (e.g. $F_2 = 900\text{kN}$, $P = 225\text{bar} = 22.5\text{MPa}$)

According to the calculated needed force, adjusting the switch on the pressure gauge, you can control the actual bending force.

Adjust working force based on the calculation. If it is less than needed, you cannot bend. If bigger, it will waste the power and affect the using life of the parts.

Bar	kN	TON (Pressure Conversion Mark)
40	90	9
70	160	16
100	220	22
130	290	29
160	360	36
190	430	43
220	500	50
250	560	56
280	630	63
310	700	70

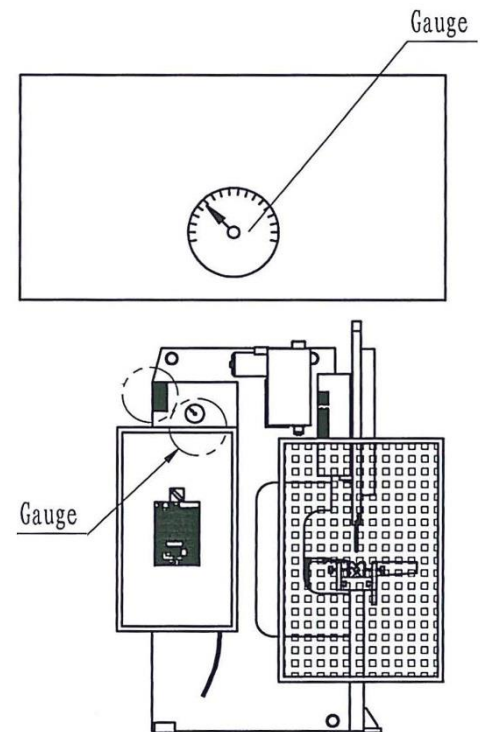

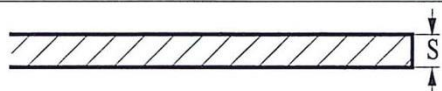
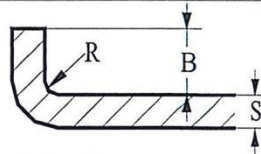
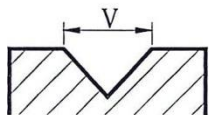

V	R	B	T = 420—480 N/mm ² (C=1)																		
			0.5	0.8	1	1.2	1.5	1.8	2	2.5	3	4	5	6	8	10	12	15	20	25	
4	0.7	2.6	40	105																	
8	1.5	5.2	20	55	80	115	180														
10	1.7	6.5		41	65	95	145	210	260												
12	2	7.8			55	80	120	175	215												
16	2.7	10.4				60	90	130	160	250	360										
20	3.4	13					75	105	130	200	290	520									
25	4.2	16						85	105	160	230	410	640								
30	5	20							140	190	340	540	770								
35	6	23								170	300	460	660								
40	7	26								150	260	400	580	1030							
45	7.5	29									230	360	520	910							
50	8.5	32									210	320	460	820	1280						
55	9	36										300	420	750	1170						
60	10	39										270	390	690	1070						
65	10.8	42										250	360	630	990	1420					
70	11.7	45											330	590	920	1320					
75	12.5	49											310	550	860	1230					
80	13.5	52											290	520	800	1160	1800				
85	14	55												490	760	1090	1700				
90	15	58												460	710	1030	1600				
100	17	65												410	640	930	1440	2560			
110	18.5	71													590	840	1310	2330			
120	20	78													540	770	1200	2130	3330		
140	24	91														660	1030	1830	2860		
170	29	110														550	850	1510	2350		
200	35	130															720	1280	2000		

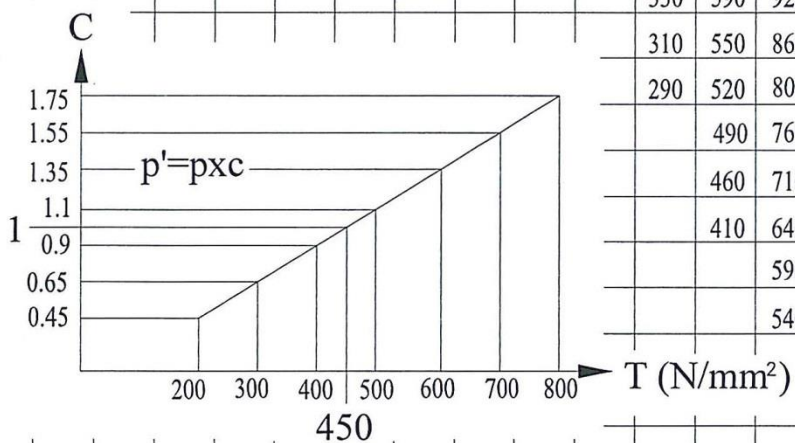

Note: The capacity of per length can not over the set value



NOTES



BAILEIGH INDUSTRIAL HOLDINGS LLC
1625 DUFEEK DRIVE MANITOWOC, WI 54220
PHONE: 920. 684. 4990 FAX: 920. 684. 3944
www.baileigh.com

BAILEIGH INDUSTRIAL HOLDINGS LTD. UNIT D SWIFT POINT
SWIFT VALLEY INDUSTRIAL ESTATE, RUGBY
WEST MIDLANDS, CV21 1QH UNITED KINGDOM
PHONE: +44 (0)24 7661 9267 FAX: +44 (0)24 7661 9276
WWW.BAILEIGH.CO.UK