

GEMPLER'S[®]

Making Hard Work Easy[™]

2020 Resource Guide



**NEW YEAR
NEW GEAR**

shop gemplers.com | 800-382-8473

over

25 FREE
gifts

to choose from!

See pages
511-515 for details

Since 1939, we've been the **trusty companion of hard-working folks** all across America.

Where to find the best brands?
Right here!

We'll always be on the lookout for the most innovative new products, from companies you know and trust. (And a few you might NOT know yet.)



See all offers at gemplers.com

Join the Conversation



Over 20,000 products at gemplers.com

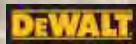

Dear friend,
If there's one thing we love, it's making your hard work easier. So we track down thousands of problem-solving products that help you do just that. The best brands, the best prices, shipped fast because we know you need them.

Are you happy with our products and service? We sure hope so. Please let me know: carl@gemplers.com.

Sincerely,
Carl Atwell, President



Budget your shipping costs for the whole year!

Pay \$59 and get 365 days of ground shipping

As many orders as you want with Shipping Saver. Item # 12SHIPSAVE



Sign up for **email specials**

Money-saving deals, new product intros, flash sales and more at gemplers.com



In Stock Orders Placed by 3pm CST
SHIP SAME DAY



Erin P.
Working at Gempler's since 2003

Ordering Information

Online gemplers.com

Phone 1-800-382-8473

Email customerservice@gemplers.com

Mail GEMPLER'S, P.O. Box 5175,
Janesville, WI 53547-5175

Fax 1-800-551-1128

Terms and Conditions: Prices listed do not include freight, handling fees, taxes, and/or duties and are subject to correction or change without notice. Customer should check gemplers.com for current pricing. A full statement of Gempler's Inc. Terms and Conditions is available at gemplers.com/pages/orders-shipping-returns and is incorporated by reference.



Promote your business

with our in-house embroidery and heat press services

- **Gempler's is your one-stop shop** – no more buying a garment one place and then having to go elsewhere to personalize
- **It's easy** – our friendly staff works with you to personalize your workwear just the way you like
- **We keep your logo on file** – making future orders super easy
- **Fast turnaround** – we'll get your order sent out in as little as 2 days from approved proof



PERSONALIZE Watch for this icon for heat press and/or embroidery options. 6 piece minimum.

More info at gemplers.com/personalize or call 1-800-382-8473.



\$ Price Match Promise
We offer fair prices 365 days a year, no games.
More details at gemplers.com/price

Independently owned and operated
Our motto: Do what's right for our customers



Hard-to-find Products

These are hidden gems! • Pgs. 6-9

Here's our guide to

NEW Products • Innovative products from top brands • Pgs. 10-21

Safety Supplies • PPE, Signs, Traffic Control • Pgs. 22-109



GEMPLER'S® Best Selling Nitrile Gloves

Extra-thick premium glove with excellent dexterity

100% nitrile gloves provide excellent protection for handling most agricultural chemicals, solvents, acids and caustics. *Specify size: S (8), M (9), L (10) or XL (11).* More styles on pg. 27.

Item #	Thickness	Lining	Length	Size	Pr./Pkg.	Price
727G	15 mil	Unlined	13"	XS-XL	1	\$2.99
12778	15 mil	Unlined	13"	S-XL	12	\$32.89
10212	15 mil	Unlined	19"	S-XL	36/Box	\$89.99

▲ WARNING: Cancer - www.P65Warnings.ca.gov



★★★★★ "Tough enough to use over and over yet cheap enough to pitch and use a clean pair!" – johnb

Sprayers & Parts • Handheld, Backpack, Trailer, 3-Point, Skid, Spot Sprayers Pgs. 110-154

GEMPLER'S® 12V Spot Sprayers

Built using a thicker polyethylene tank and more UV inhibitor, these sprayers are versatile enough for precision jobs and tough enough to last year after year. More details on pg. 128.

Item #	Size	Pump Flow	Price
230452	15 gal.	1.0 GPM	\$99.99
230453	15 gal.	2.2 GPM	\$169.99
230454	25 gal.	1.0 GPM	\$103.99
230455	25 gal.	2.2 GPM	\$174.99



Landscape & Nursery Supplies • Nursery, Lawn & Garden, Weather Testing & Monitoring, Irrigation & Watering • Pages 155-276



Powder-coated to prevent rust

Welded to base

Slight upward angle so tools won't slide off

16-ga. steel tubing

3/8"-dia. mounting holes

Best Tool Rack... EVER!

More styles on page 169.

Item #	Description	Price
HR12	12"L, two-tine, wall-mount	\$15.99
HR13	Long, 20" two-tine, wall-mount	\$21.99

USA MADE

Pest Management • Repellents, Traps, Bait • Pages 277-306

The Mole Eliminator® Trap eliminates moles on the first try

Durable electroplated steel stands up to years of use. Place scissor-like trap over active "travel" tunnels, which tend to be long and straight. Set by pressing down the activator with your foot. 6"L x 6"W x 12"H.

RMEL \$32.99



Simply step on the activator to set trap

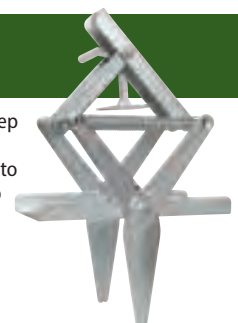

Shop Supplies • Rust Control, Facility, Fencing, Tarps, Storage, Tire Repair
Pgs. 307-391



GEMPLER'S Rust Converter seals out moisture to prevent future rusting

No sandblasting, heavy scraping or grinding necessary. Easy to use and easy to clean up. Paint over with oil-based paint. Environmentally safe, non-flammable. More sizes and details on pg 360.

Paint On, 1 qt. # **RCQ** \$15.79
Paint On, 1 gal. # **RCG** \$52.79

Easily paint or spray onto rust and watch it convert like magic

Workwear • Rainwear, Outerwear, Pants, Jeans, Shorts, Accessories • Pages 392-460

-  Black
-  Navy
-  Orange
-  Tarmac



carhartt Dry Harbor Coat and Cargo Pants

Storm Defender technology locks out water, yet lets sweat escape so you stay dry on the job. *Specify color and Men's size.* More details on pg 421.

Item #	Description	Size	Price
103510	Coat	S-2XL Reg.	\$79.99
		3XL Reg., L-2XL Tall	\$89.99
103507	Pants (Black only)	S-2XL Reg.	\$79.99
		3XL Reg., L-2XL Tall	\$89.99

Footwear • Boots & Shoes, Waders, Overboots & Overshoes, Socks • Pages 461-494

-  River Green
-  Tan
-  White

NEW BOGS Men's 11" Bozeman Insulated Boots - rated to -72 below!

Seamless construction makes these boots 30% lighter! Thick rubber shell is 100% waterproof, insulated with Neo-Tech stretch bootie. Lined with Ever Dry and Bogs MaxWick to evaporate sweat. Bio-Grip outsoles are chemical and slip-resistant, non-marking and self-cleaning. *Specify Men's whole size 7-15.* More styles on pg 481.

231160 \$145.00



Outdoor Lifestyle • Coolers, Drinkware, Packs, Totes, Carhartt Pet, Personal Care, Sunglasses • Pgs. 495-504

NEW YETI Tundra Haul 50 Cooler

Two wheels and a tow handle make it easy to haul, even if you fill it to its 45-can capacity. Rolls easily over sand, grass, rocks and unpaved areas. 19-1/2"H x 18-5/8"W x 28-1/4"D. *Specify color: Charcoal, River Green Tan or White.*

YTUNH50 \$399.99



**USA
MADE**

Table of Contents
Pgs. 505-509

Order Form
Pg. 510

Free Gifts: Over 25 gifts
to choose from! **Pgs. 511-515**



Make quick hose repairs right on the spot!

Clamtite Tool lets you make "stronger than steel" hose clamp repairs anywhere ...and, on just about any hose. Choose **Stainless Steel Wire** (#HC50 available separately at gemplers.com) so your clamps won't rust. Measures 4-3/4".
HC8 \$35.99

★★★★★
"best tool in its class. This tool is so good for it's intended purpose it should be illegal!!! A bit hard to use the first time, it gets easier and, when used properly, will make any size clamp you want. I have used it on hydraulics in the field, on water hoses at home, and on air hoses and torch hoses at work. It works great and is a great asset in my tool box."
 — rataakr



Versatile Tool System is easy to transport and store

Ingenious and handy WOLF Gärten interlocking-tool systems are both sturdy and powerful. Zinc coated to prevent rust. Handle and heads sold separately.

59"L Standard Handle – Red nylon coating offers a comfortable grip and adds strength. Made of 1-1/16" rolled aluminum.

Combination Tool Head – Sturdy 10-ga. steel tines won't bend under hard use. Perfect for weeding and breaking up soil.

"The Crumbler" Head – Steel teeth pierce and break up stubborn top soil for proper drainage and easier weeding.

Draw Hoe Head – Excellent all-around weeding and cultivating tool.

Bow Rake Head – Spreading topsoil, mulches, working fertilizer into soil. Choose for hatching grass and general yardwork. 13"W head.

Trowel Head – Attach to handle or use on it's own as a hand tool for precise digging tasks.

Pruning Saw Head – Swedish steel blade cuts through limbs up to 2" thick with speed and precision.

Item #	Description	Price
139074	Standard Handle	\$16.49
139077	Combination Tool Head	\$20.99
139078	"The Crumbler" Head	\$42.99
139079	Draw Hoe Head	\$15.99
139080	Bow Rake Head	\$20.99
139084	Trowel Head	\$12.99
139087	Pruning Saw Head	\$44.99

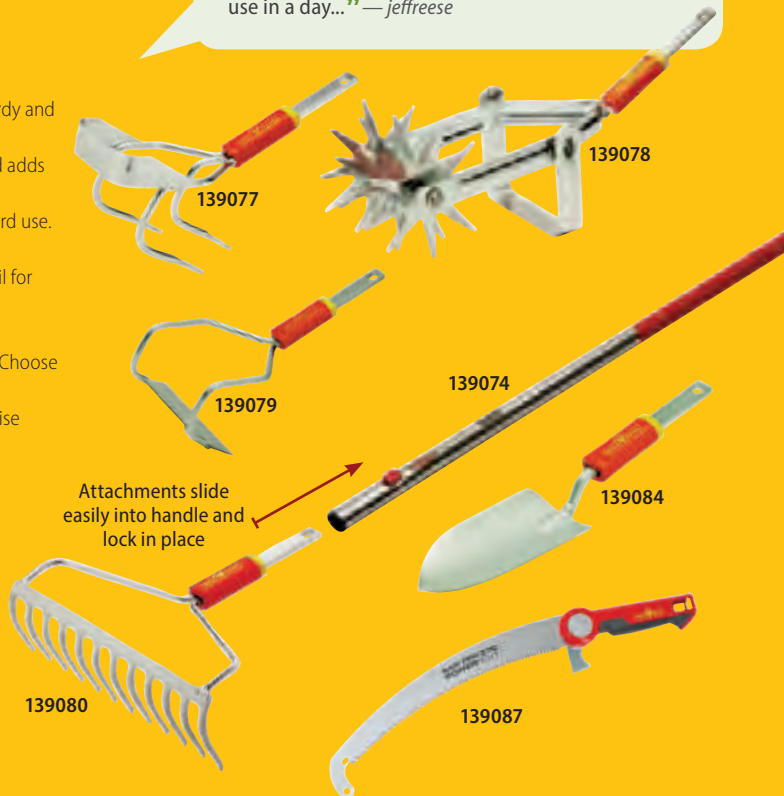

★★★★★
"Very well made. I don't use all the tools all the time. Now I can store the attachments and reduced the number of full time polls to what we can use in a day..." — jeffreese

8"L Mower Deck Scraper

Unique, rounded-head scraper is easy to use on the underside of a rotary mower deck, unlike straight-edge tools. Electrocoated carbon-steel blade with polypropylene handle. Plated steel grommet construction for durability.

134101 \$14.99



★★★★★
"A MUST HAVE TOOL! This is a VERY STURDY, HIGH QUALITY TOOL ! Really makes cleaning mower decks a lot easier. Especially like to see that it's MADE IN USA !!." — frankpisha



Includes flex hose extender and coupler

Unclog stubborn grease joints!

Grease Joint Rejuvenator Cleaning Tool features unique 1144 stress-proof steel. Tool injects light-viscosity oil into grease joints or fittings to unclog hardened grease. Kit includes 8-1/2"L tool and flexible 4,800-psi hose extension for difficult-to-reach fittings. Lifetime warranty.
109643 \$49.99

★★★★★
"GAD ZERKS!!! After a couple hits with hammer, the Zerk was cleared and ready for greasing. Saved having to remove old fittings which eliminated the possibility of breaking on off. Cleared a total of 26 fittings in less than 30 minutes on some old tractors and axillary equipment." — *ddzierski*

★★★★★
"I would recommend this product. I love the pass thru sockets. The tray that holds them has a magnetic base which holds the sockets and I am able to set the tray in my tractor tool box without the sockets getting loose. If i can use a socket they are the first thing I reach for." — *jwarren231*



Reach any fastener, no matter its length

Crescent X6 Pass-Thru Socket Set's innovative pass-thru design will work with any length fastener. Six fastener types - square, 12 pt., E-Torx, Hex, partially rounded hex and spline. Includes 3/8" ratchet and adapter.
223434 \$39.99



Sockets fit:
SAE 3/8", 7/16",
1/2", 9/16", 5/8",
11/16", 3/4",
13/16", 7/8",
MM 10, 11, 12, 13,
14, 15, 17, 18, 19.

★★★★★
"The Puller is worth every cent! We have felled very large elm trees using the Puller. It works better than expected. The fact the line is "unlimited" keeps one from running out of pulling power as one would using fixed length cable."
— *dsusdive*

Unique ratchet lets you pull any length of rope
"Another Great Product from Gempler's" — *mmwat*

3/4-Ton, Unlimited-Length Rope Puller

Heavy-duty come-along features an **innovative feed-through design** that lets you pull an unlimited length of 1/2"-dia. rope. Unlike traditional cable, rope is safer to use, is non-conductive and will not scratch surfaces. Comes with 20' of highway approved 1/2" Dacron™ polyester rope with snap hooks or use your own rope to reach the distance you need.
125983 \$96.99



- IDEAL FOR:**
- Handling logs, trees and stumps
 - Recovering vehicles
 - Securing material to trucks or trailers
 - Clearing debris



★★★★★
"This is the weeder you dream about! This is the weeder you dream about! Simple, effective, and actually sort of fun. I give them as gifts to my gardening friends who haven't heard of them. Everybody is astonished at how they grab the root and pull it without breaking it off. SO glad you carry these!" — *jaimeequiscape*

Remove weeds without bending, pulling or kneeling!

Grampa's Weeder® Tool is an ingenious, lightweight, easy-to-use solution for removing stubborn weeds without chemicals. Hand-casted iron head and a 39"L hardwood handle. Lifetime guarantee.
151206 \$24.99

Remove weeds... root and all!



CENTER



PRESS



LEAN





★★★★★
“Don’t pull out T-Posts without this tool.
 Pulls a T-Post out of the ground quickly and easily without having to struggle. No need to add water, dig around the post, wiggle it back and forth, and strain your back trying to pull it out by hand. Even if you only pull out a few T-Posts a year, this product is well worth having around. Should have bought one years ago...” — *info*



T-Post Puller pairs with a jack to remove posts... even from hard, frozen ground

Simply hook **T-Post Puller** onto the T-post and ratchet up with a handyman jack (not included). Pulls posts straight up without bending them. Extremely durable ductile steel resists rust and corrosion. 6-1/4"L x 3"W. Accommodates T-posts up to 2"W.
 # M1195 \$21.99

Easily remove stubborn, bent or broken posts

Heavy-Duty Post Puller removes stubborn posts without the struggle. Constructed of heavy-duty, 1-1/2" square tubing. Add the **Chain and Slip Hook Accessory** (sold separately), to remove construction stakes, galvanized fence posts, wood posts, U-channel posts and more.

Item #	Description	Price
LJ27	Heavy-Duty Post Jack	\$89.99
HA35	Chain and Slip Hook Accessory	\$23.99

★★★★★
“Fantastic Product. Pretty simple product. One piece of cast iron with two holes. Worked fantastic. I pulled post that were so set in clay that the tractor front end came off the ground. You do not need to pull many posts to make it pay for itself. I had previously tried pulling post with a chain that kept slipping.” — *grisher*

★★★★★
“Great product, reliable. Great product, durable, long lasting. I have used them for years. I can’t see any purpose of buying something imported for almost as much money and then throwing it away in a few years; waste of money, waste of material, waste of energy.” — *denpurcell*



In-tank baffle limits liquid movement to increase ease of use

INDIAN Our most rugged fire pump boasting 80+ years of dependability

5-gal. Galvanized Steel tank with premium, all-brass pump for years of reliable, bind-free operation. Dual nozzle switches quickly for a stream or spray pattern. Large, 4"-dia. fill opening. Ventilated, watertight, cam-lock cap. Includes heavy-duty, adjustable shoulder straps and contour back support.

170300 \$184.99

“great on ice”
 — *tony.larson*

Find replacement cleats (# 219211) at gemplers.com



NEOS OVERSHOE Voyager™ Overboots with STABILicers™ Outsole

Anti-skid outsole and 100% waterproof protection to keep you on your feet and make your work shoes last longer. The 500-denier nylon upper is lightweight, yet durable and long-wearing. Wide opening can even accommodate steel-toe work boots. Adjustable strap ensure a snug fit while back pull strap makes them easy to pull on. Men’s: M (7-1/2-9), L (9-1/2-11), XL (11-1/2-13) or 2XL (13-1/2-15). **NOTE:** We recommend sizing up when wearing over work boots.

139251 \$102.99

★★★★★
“A must for working outside and inside.
 I do wood damaging insect inspections on homes. This requires me to check the outside as well as inside, regardless of exterior conditions. Shoes free of snow that would track water inside a home are a must. These are easy on, easy off, and they keep your feet dry, warm, and clean. I highly recommend.” — *bob*

100x stronger than duct tape—Perfect for emergency repairs!



FiberFix™ Tape hardens like steel to fix nearly any broken object

Simply get FiberFix™ Tape wet to activate. Repair Wrap dries/hardens in 10–15 min. Perfect for fixing tool handles, hoses, irrigation lines and plumbing. Sandable and paintable.

Item #	Type	Roll Size	Price
224967	Repair Wrap	1"W x 40"L	\$6.29
224968	Repair Wrap	2"W x 50"L	\$8.49
224969	Repair Wrap	4"W x 60"L	\$10.49

▲ WARNING: Cancer - www.P65Warnings.ca.gov

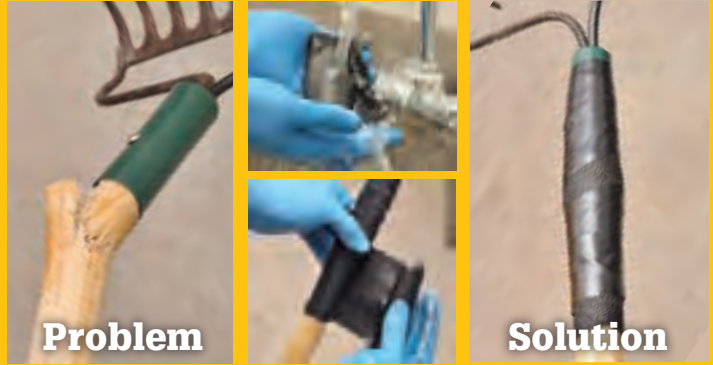

"I would buy this product again."

This is by far the best tool I have ever had to pick up items off the ground. I use mine primarily to pick up sticks which have fallen out of the trees especially after wind storms. No more stooping over!" — dbleagle



"Works Great." This is the item you don't think you need in your life but you do. It saved my beloved papasan chair for years to come." — Shea



Collect litter without bending over

Save time and reduce backaches with **36"L Trash Tongs**. Lightweight, durable aluminum tubing for long-term use. Comfortable, padded rubberized handgrip.
2928 \$34.79

Jaws pick up items as small as a penny



Instant relief for dry, chapped hands

Non-greasy, hypoallergenic **Wool Wax Creme** features lanolin to soften skin naturally. 9-oz. jar.
WWC9 \$7.99



"the best hand cream ever."

Love this stuff. My hands aren't cracked all winter long when I use this product." — colctcrump



"This stuff works."

My butterfly bushes were getting stripped clean by baby hoppers... I was about ready to just pull them out and try something else when I read about Garlic Barrier. I gave it a try and WOW! This stuff works. I notice all the new growth is untouched by the pesky hoppers. I'm sold!" — zeke



"Faster and easier way to build fence!"

Great product, shock absorbers work well, less fatigue and stress!" — james_f...

The most ergonomic manual post driver on the market

Field Tec Adjustable Shock-Absorbing Post Driver

Jarring impact forces are directed away from the operator thanks to innovative shock absorbers. Handles adjust for access into tight corners. Built-in leveling system helps drive posts straight.
227034 \$79.99



The tapered end quickly slides over posts

Keep insects and wildlife from gnawing on vegetation with Garlic Barrier® Repellent

Garlic odor disperses in minutes. Deter pests for up to 10 days. Dilute with water 10:1. One quart makes 2.75 gal., enough to cover 10,890 sq. ft. Listed by the Organic Materials Review Institute (OMRI) for organic growers. **NOTE: Can't be sold or shipped to AL, AK, AR, DE, ID, IA, KS, KY, LA, MS, ND, SC, WA, WV, WY, District of Columbia, Army Post Office, U.S. Territories or International.**
R42406 \$12.99





NEW

GEMPLERS
**Gempler's
 Cobrahead Mini
 Weeder &
 Cultivator**

Built to the same toughness as the Original CobraHead, the "mini" features a fully tempered forged steel blade and a nearly unbreakable composite plastic handle that is comfortable in almost any hand. CobraHead tools are built to last and can be counted on for years of service.

Item #	Price
193247	\$24.95



NEW

GEMPLERS
**Gempler's
 Cobrahead Weeder
 & Cultivator**

This hand cultivator comes with a blade designed to cut through any soil, even clay. Its slender design gives it an unprecedented level of precision without sacrificing durability.

Item #	Price
193248	\$27.95



NEW

GEMPLERS
**Cobrahead Long
 Handle Weeder &
 Cultivator**

The blade can cut hard soil with less resistance than a wider hoe or multi-tined tool. The CobraHead will break through the toughest crusted soil, without breaking your back. The ergonomic design is best used with a sweeping action, raking sideways across your body and not bending over, making it easy to get at those hard to reach weeds!

Item #	FO	Price
193249	■	\$64.95

■ Oversize item: additional shipping charges will apply.



NEW

FIXED Tree Brace™

Tree hugger® FIXED Tree Brace™ is a revolutionary patented labor and time saving tree support system for staking trees. Using tree hugger® tree brace™ eliminates the need for staking trees the old conventional way. To batten and stake a tree is a consuming process involving man time and specialty tools. The tree hugger® tree brace™ has reduced considerably the man time and eliminates almost all the tools necessary including specialty tools. Our tree hugger® tree brace™ is a green, sturdy and re-usable USA made product.

Item #	Price
193241	\$59.95



NEW

ADJUSTABLE Tree Brace™

Tree hugger® ADJUSTABLE Tree Brace™ is a revolutionary patented labor and time saving tree support system for staking trees. Using tree hugger® tree brace™ eliminates the need for staking trees the old conventional way. To batten and stake a tree is a consuming process involving man time and specialty tools. The tree hugger® tree brace™ has reduced considerably the man time and eliminates almost all the tools necessary including specialty tools. Our tree hugger® tree brace™ is a green, sturdy and re-usable USA made product.

Item #	Price
193242	\$69.95



NEW

GEMPLERS Leaf Burrito Reusable Yard Debris Super Bags

Reusable! Keeps single-use plastic bags out of our landfills

The Leaf Burrito is an ingenious new yard debris system that makes the arduous task of bagging leaves, hedge clippings, weeds, sticks, and grass clippings be an incredibly simple and eco-friendly experience! It starts completely flat for instant loading then burritos up with heavy duty zippers. The 5' residential burrito holds 4+ large plastic bags of leaves and the 7' commercial burrito holds 6+ bags.

Item #	Length	Price
231237	5'	\$69.00
231237	7'	\$84.00



NEW
**FLEXVOLT® 60V MAX*
 Handheld Blower Kit**

Variable speed trigger and speed lock for total power control, and its lightweight and ergonomic design maximizes control and minimizes stress on your arms. Contains a FLEXVOLT 20V/60V MAX* 6.0Ah battery.

Item #	Price
DCBL770X1	\$329.00



NEW
**FLEXVOLT® 60V MAX*
 Brushless Chainsaw Kit**

Features tool-free chain tensioning and a bar tightening knob to enable proper bar clamping force, with auto-oiling for continuous lubrication. This kit includes a FLEXVOLT 20V/60V MAX* battery.

Item #	Price
DCCS670X1	\$369.00



**FLEXVOLT® 60V MAX*
 Cordless String Trimmer Kit**

Designed to power through tough overgrowth and withstand everyday heavy-duty usage. Features a high-efficiency brushless motor that maximizes runtime and motor life. Lightweight, ergonomic design maximizes control and minimizes stress. This kit includes a FLEXVOLT 20V/60V MAX* battery.

Item #	Price
DCST970X1	\$289.00



NEW
**DEWALT 20V Max Compact
 Chainsaw**

This battery-powered chainsaw is built to handle tough construction and outdoor work. The lightweight design maximizes user control. Its brushless motor technology delivers extreme runtime and long motor life. Kit includes a 5.0Ah 20V MAX* battery, charger, and a hard bar cover.

Note: not for sale in (AL;GA).

Item #	HM	Price
DCCS620P1	▲	\$229.00

▲ Requires special handling due to DOT regulations. Additional shipping charges will apply. Cannot be shipped by air.



NEW
**DEWALT 20V Brushless
 Blower with 5AH
 Pack**

Clear debris with an air volume of up to 400 cubic feet per minute at 90 miles per hour. With an ergonomic and extremely lightweight design, the blower is easy to control and minimizes stress on the arm. The variable speed trigger and speed lock give the user full power control.

Note: not for sale in (AL;GA).

Item #	HM	Price
DCBL720P1	▲	\$199.00

▲ Requires special handling due to DOT regulations. Additional shipping charges will apply. Cannot be shipped by air.



NEW
**20V/60V MAX* FLEXVOLT
 9.0Ah BATTERY**

Dual-voltage 20V/60V MAX* FLEXVOLT® 9.0 Ah battery automatically changes voltage when you change tools, providing up to 6X runtime** in 20V MAX* tools and the power of corded in 60V MAX* and 120V MAX* tools.

Item #	Price
DCB609	\$179.00



NEW

20V MAX* XR 9 GA Cordless Fencing Stapler Kit

The DEWALT® Cordless Fencing Stapler, designed for rural applications is 100% battery operated, eliminating the need for fuel cells and the hassle of a hose and compressor. Variable power settings, tool-free depth of drive and jam clearing give the user confidence to get the job done quickly and efficiently. The ergonomic design, versatility, and convenience makes the DCFS950 a tool for agricultural fencing and utility applications. Compatible with all DEWALT 9 GA Fencing Staples available in three common sizes, 1-1/2", 1-3/4", 2" (sold separately).

Item #	Description	Price
--------	-------------	-------



NEW

DEWALT 2200-Watt Gas Powered Inverter

Powered by a DeWALT 80cc OHV engine with Auto Throttle and low oil shutdown which protects the engine from damage. Onboard CO-Protect Technology automatically shuts down the generator if CO levels become unsafe or rapidly increase.

Item #	FT	Price
193246	*	\$749.00

*Item ships by Truck due to size and weight.



NEW

DEWALT 6500-Watt Portable Gas Generator

The 6500 Watt Portable Gas Generator is powered by a 389cc engine with low oil shut off which protects the engine from damage. The 7.5 Gal. steel fuel tank provides up to 10 hours of runtime at 50% load. The 1 1/4" steel tube frame helps protect it from jobsite conditions.

Item #	FT	Price
193244	*	\$899.00

*Item ships by Truck due to size and weight.



NEW

DEWALT 4000-Watt Portable Gas Generator

The 4000 Watt Portable Gas Generator is powered by a 223cc engine with low oil shut off which protects the engine from damage. The 3.4 Gal. steel fuel tank provides up to 10 hours of runtime at 50% load. The 1 1/4" steel tube frame helps protect it from jobsite conditions.

Item #	FT	Price
193243	*	\$549.00

*Item ships by Truck due to size and weight.



NEW

DEWALT 8000-Watt Portable Gas Generator

The 8000 Watt Portable Gas Generator is powered by a 420cc engine with low oil shut off which protects the engine from damage. CO-Protect Technology automatically shuts down the generator if carbon monoxide levels become unsafe or rapidly increase. 7.5 Gal. steel fuel tank provides up to 9 hours of runtime at 50% load.

Item #	FT	Price
193245	*	\$1,169.00

*Item ships by Truck due to size and weight.



NEW

DEWALT 20V Max Compact 4-Tool Combo Kit

The 20V MAX* combo kit is ideal for most cutting and drilling applications. This kit includes a compact drill, reciprocating saw, circular saw and worklight. A contractor bag allows for portability of the kit. Note: not for sale in (AL;GA).

Item #	HM	Price
DCK423D2	▲	\$249.00



NEW

DEWALT 20V MAX Li-Ion Compact Drill & Impact Combo Kit (1.5 Ah)

The 20V MAX* Lithium Ion Compact Drill/Driver / Impact Driver Combo Kit (1.5 Ah) features a two-speed transmission and LED lights for working in dark spaces. Note: not for sale in (AL;GA).

Item #	HM	Price
DCK280C2	▲	\$249.00

▲ Requires special handling due to DOT regulations. Additional shipping charges will apply. Cannot be shipped by air.



NEW

DEWALT 20V XR Brushless 4.5in Grinder Kit

The small angle grinder has a brushless motor that elongates motor life and requires no time changing out worn brushes. Its Kickback Brake engages maximum force to stop the wheel when there is a pinch, stall, or bind-up to reduce kickback, and will shut off for further protection. Note: not for sale in (AL;GA).

Item #	HM	Price
DCG413R2	▲	\$349.99



NEW

DEWALT 20V Max Brushless 7 1/4 Circ Saw Kit

Electronic brake helps stop the blade after releasing trigger to increase protection. Long runtime and a durable, high-grade magnesium shoe add to the performance of this powerful cordless tool. Note: not for sale in (AL;GA).

Item #	HM	Price
DCS570P1	▲	\$279.99

▲ Requires special handling due to DOT regulations. Additional shipping charges will apply. Cannot be shipped by air.



NEW

DEWALT 20V MAX Lithium Ion Reciprocating Saw Kit (5.0 Ah)

Delivers up to 3000 strokes per minute, allowing you to match speed with application and a 1-1/8" stroke length for fast cutting. The keyless lever-action 4-position blade clamp makes changing blades quick and easy. Note: not for sale in (AL;GA).

Item #	HM	Price
DCS380P1	▲	\$259.99

**NEW**

60V MAX* FLEXVOLT® 2.5 Gallon Cordless Air Compressor Kit

Offers all of the convenience and portability of cordless, and lets you continue using the pneumatic tools you already have. Each battery charge allows for up to 1,220 nails**, providing the runtime to complete a variety of applications. Its OneTurn™ Regulator means you no longer have to fight with the dial. Plus, it's made right here in the USA with global materials.

Item #	Price
DCC2560T1	\$379.00

**NEW**

12V/20V MAX* Jobsite Bluetooth® Speaker

Enhance your workday by streaming your favorite music or podcasts from your Bluetooth® equipped mobile device from up to 100 ft. away. Power the Jobsite Bluetooth® Speaker with DEWALT 12V MAX*, 20V MAX*, or FLEXVOLT® batteries, all sold separately. Includes universal AC cord. Comes with 3-year limited warranty.

Item #	Price
DCR010	\$109.00

**NEW**

XP™ 20 oz. Steel Hammer

This hammer offers up to 35% less sting to help reduce arm fatigue and 25% improved grip durability. Thick, heat-treated shaft for added durability in tough conditions. Quickly remove finish, framing and large construction nails as well as staples with its versatile pulling features.

Item #	Price
DWHT51380	\$29.99

**NEW**

ToughSystem® Organizer

Keep your accessories and supplies securely stored with this ToughSystem® Organizer. It includes 4 large and 8 small removable cups so you can securely keep small items and is fully compatible with the ToughSystem® storage line.

Item #	Price
DWST08202	\$39.99

**NEW**

ToughSystem® DS300 Large Case

The ToughSystem® Large Case features a durable structural molded foam wall and an integrated water seal to protect the tools inside of it on the jobite. With an IP65 rating, this unit is water and dust resistant.

Item #	Price
DWST08203	\$59.99



NEW



Intceptor Compact Folding Earmuff

High performance earmuff offers excellent noise reduction rating of 29. Lightweight design provides all day comfort.

Item #
231667

Price
\$24.99



NEW



Bluetooth Earmuff

Protects your hearing while offering Bluetooth wireless technology for streaming and phone calls. High-Fidelity speakers provide premium sound. NRR 25. Rechargeable Lithium Ion Battery.

Item #
231668

Price
\$59.99



NEW



Radius 10 Base Curve Safety Glasses

Tough, polycarbonate lens provides impact resistance. Exceeds ANSI Z87.1+ standards and provides 99.9% UVA/UVB protection.

Item #
231670

Price
\$5.99

- Clear
- Silver Mirror
- Indoor/Outdoor
- Smoke



NEW



Crosscut Safety Glasses

Wide Wrap Lenses. Soft Rubber Nosepiece. Comfort Fit Temples. Impact Resistant Polycarbonate Lenses. Safety glass exceeds ANSI Z87.1+ standards. Provides 99.9% UVA/UVB protection.

Item #
231669

Price
\$6.99

- Clear
- Indoor/Outdoor
- Smoke



NEW



Concealer Safety Goggles

Soft, dual injected rubber conforms to the face to provide a high level protection from dust and debris. Polycarbonate lens meets ANSI Z87.1+ standards and provides 99.9% UVA/UVB protection.

Item #
231672

Price
\$12.99

- Clear
- Smoke



NEW



20V/12V MAX Black Heated Hoodie

This jacket features 3 Core Heating Zones and 3 temperatures. Comfortable outer shell with a thermal lining delivers lightweight warmth that can be used on it's own or to layer in cold temperature.

Item #	Size Range	Price
231679	S-3XL	\$179.99



NEW



Heated French Terry Heathered Gray Cotton Hoodie Bare

Comfortable outer shell with a thermal lining delivers lightweight warmth that can be used on it's own or to layer in cold temperature. This is a "Bare" item meaning it comes with the DCB092 adapter and can be used with your DEWALT® 20V battery.

Item #	Size Range	Price
231685	S-3XL	\$179.99



NEW



Heated RealTree® XTRA Camouflage Hoodie

The REALTREE XTRA Camouflage shell with thermal waffle knit lining provide warmth that can be used on it's own or as part of a layering system. This is fully outfitted with a DEWALT® 20V battery, fast charger and DCB092 adapter and can be used with your DEWALT® 20V battery.

Item #	Size Range	Price
231681	S-3XL	\$229.99



NEW



Heated Black Soft Shell Jacket

This jacket features 4 Core Heating Zones and 3 temperatures. The outer shell is wind and water resistant while the lining is a soft and comfortable fleece. This is a "Bare" item meaning it comes with the DCB092 adapter and can be used with your DEWALT® 20V battery.

Item #	Size Range	Price
231677	S-3XL	\$249.99



NEW



Heated Black Quilted Soft Shell Jacket

Heated Quilted Soft Shell Coat provides hours of core warmth with 3 core heat zones and 3 temperature settings. Super lightweight insulated, quilted wind and water resistant outer shell with a easy on/off smooth finish lining. Bare: Includes Adapter Only. Use with your DEWALT® 20 V Battery.

Item #	Size Range	Price
231682	S-3XL	\$239.99



NEW



Heated Heavy Duty Black Work Coat

5 heat zones and 3 temperature settings. Durable, wind and water resistant Duck cloth outer shell with flannel and fleece lining. This is a "Bare" item which includes the DCB092 adapter only and can be used with your DEWALT® 20V batteries.

Item #	Size Range	Price
231683	S-3XL	\$249.99

NEW GENERAC **Don't get caught**
with your power down!
Find full product details at genpowers.com/generac



GP2200i Inverter Generator, 50 ST/CSA
Revised, impact resistant 1.2-gallon fuel tank.
Run time of 10.75 hours at 25% rated load (heavy)
AC rated output running watts: 1,600
AC maximum output starting watts: 2,200
7117 \$679.00



IQ3500 Inverter Generator, 50 ST/CSA
Revised, impact resistant 2.6-gallon fuel tank.
Run time of 10.9 hours at 50% rated load (medium)
AC rated output running watts: 3,000
AC maximum output starting watts: 3,500
7127 \$1,449.00



GP3500iD Inverter 50 ST/CSA
Warmth of a mitt, feel of a glove
Revised, impact resistant 3.37-gallon fuel tank.
Run time of 8 hours at 50% rated load (medium)
AC rated output running watts: 3,200
AC maximum output starting watts: 3,500
7128 \$789.00



Handles fold for transport
Never-flat tires
XC6500 Portable, 49 ST/CSA
Revised, impact resistant 6.5-gallon fuel tank.
Run time of 18 hours at 50% rated load (medium)
AC rated output running watts: 4,000
AC maximum output starting watts: 6,125
6823 \$2,079.00



Handles fold for transport
XC8000E Portable, 49 ST/CSA
Revised, impact resistant 6.5-gallon fuel tank.
Run time of 11 hours at 50% rated load (medium)
AC rated output running watts: 4,000
AC maximum output starting watts: 3,000
6826 \$2,679.00



XD5000E Diesel Portable, 50 ST
Diesel powered for less maintenance
Large capacity 12-gallon fuel tank.
Run time of 14 hours at 50% rated load (medium)
AC rated output running watts: 5,000
AC maximum output starting watts: 7,000
6864 \$3,799.00



Handles extend for easy portability
Never-flat tires
GP6500 389 PR 495T
Revised, impact resistant 6.4-gallon fuel tank.
Run time of 11.5 hours at 50% rated load (medium)
AC rated output running watts: 4,500
AC maximum output starting watts: 6,125
7690 \$789.00



SPEEDWASH™ 2900 PSI 2.4 GPM
Power sprayer has a maximum output pressure of 2900 psi and a maximum flow rate of 2.4 gpm. Includes variable speed spray gun with PowerDial™ and a 50-ft. coiled high hose.
6882 \$379.00



3100 PSI E-Start Pressure Washer
Electric Start with Lithium-Ion battery
Power sprayer has a maximum output pressure of 3100 psi and a maximum flow rate of 2.0 gpm. Includes: variable speed spray gun with PowerDial™ and a 50-ft. polyurethane hose, Power Broom and Soap Blaster.
7143 \$489.00



NEW

LIFETIME Vertical Storage Shed (53 cubic feet)

Strong and dependable, the vertical shed is rust and weather resistant and can hold many of your outdoor products and tools. This attractive cabinet will be the perfect storage unit for your yard.

Item #	FT	Price
193177	*	\$399.00

*Item ships by Truck due to size and weight.



NEW

LIFETIME 7 Ft. x 4.5 Ft. Outdoor Storage Shed

Lifetime's 7-foot wide Outdoor Storage Sheds have several innovative features, including a skylight that runs the entire length of the roof. Low-maintenance, steel-reinforced construction.

Item #	FT	Price
193174	*	\$865.00

*Item ships by Truck due to size and weight.



NEW

LIFETIME 8 Ft. x 10 Ft. Outdoor Storage Shed

High-Pitched Roof Allows for Quick Drainage of Rain and Snow. Heavy-Duty Steel Trusses Provide Additional Roof Strength. Sturdy Steel-Reinforced Construction.

Item #	FT	Price
193173	*	\$1,199.99

*Item ships by Truck due to size and weight.



NEW

LIFETIME Heavy-Duty Outdoor Storage Deck Box (80 Gallon)

Lifetime Outdoor Storage Box - Features an interior capacity of 80 gallons (10.7 cubic feet). It has a black bottom and desert sand (tan) sides and lid. Comes in (1) box.

Item #	FT	Price
193176	*	\$169.99

*Item ships by Truck due to size and weight.



NEW



**Men's Iso-Chill
Shore Break Crew**

Full cut body provides complete all day comfort. Iso-Chill fabric disperses body heat and sweat, keeping you cool and dry. UPF 50+ protects against harmful rays.

Item #	Size Range	Price
1344119	S-3XL	\$40.00

-  Halo Gray
-  Pitch Gray





NEW



**Men's Freedom
Tech Terry Hoodie**

UA Freedom Under Armour is committed to a minimum donation of \$250,000 annually to support First Responders, Military Personnel, Law Enforcement Officers & Veterans.

Item #	Size Range	Price
1323105	S-3XL	\$55.00

-  Black
-  Steel



NEW



**Men's Iso-Chill
Shore Break 1/2-Zip**

Iso-Chill fabric helps disperse body heat, making it feel cool to the touch. Features a full stretch-mesh back for maximum breath-ability and mobility. UPF 50+.

Item #	Size Range	Price
1352098	S-3XL	\$60.00

-  Halo Gray
-  Pitch Gray



NEW



**Men's Rival Fleece
Full-Zip**

Ultra-soft, 230g cotton-blend fleece and a full cut make this sweatshirt perfect for all day comfort. Moisture and sweat wicking fabric keep you dry. Specify Size and Color.

Item #	Size Range	Price
1320737	S-3XL	\$55.00

-  Black
-  Charcoal Heather
-  Light Heather
-  Academy







NEW



**Men's Tech 2.0 1/
2-Zip**

Perfect for layering with a loose fit for all day comfort. UA Tech fabric is sweat wicking and fast drying. Anti-Odor Technology.

Item #	Size Range	Price
1328495	S-3XL	\$40.00

-  Black
-  Carbon Heather
-  Academy
-  Versa
-  Blue



NEW



**Men's Cold Gear
Sprint Hybrid**

Strategic 80g synthetic insulation keeps you warm where you need it with no excess bulk. Wind-resistant body panel for durability and protection.

Item #	Size Range	Price
1355118	S-3XL	\$100.00

-  Black
-  Versa Blue



NEW



**Women's Iso-Chill
Shore Break Long
Sleeve**

100% polyester IsoChill fabric disperses body heat efficiently, keeping you cool and dry. Built-in UPF 50+ sun protection blocks harmful UV rays - recommended by the Skin Cancer Foundation.

Item #	Size Range	Price
1351132	XS-2XL	\$40.00

- Dash Pink
- Aqua
- Float



NEW



**Women's Fusion
Pant**

Relaxed fit with UA Storm Technology to repel water. Elastic waist band with draw cord and ventilation panels on the lower back leg.

Item #	Size Range	Price
1325806	XS-XL	\$65.00



NEW



**Women's Twist 1/2
Zip**

UA Tech fabric is quick drying, ultra soft and has a natural feel. Anti-odor technology. 1/2 zip front with standard collar for extra coverage.

Item #	Size Range	Price
1320128	XS-XL	\$45.00

- Black
- Blue Haze
- Hushed
- Turquoise



NEW



**Women's Rival
Fleece Full-Zip**

Ultra-soft, mid-weight cotton blend fleece with brushed interior for extra warmth. High Shine Graphics. Raglan Sleeves.

Item #	Size Range	Price
1348559	XS-2XL	\$55.00

- Steel
- Medium Heather
- Dash Pink
- Medium Heather



NEW



**Heat Gear
Women's Legging**

Ultra-tight, second skin fit for a lock in feel. HeatGear fabric delivers superior coverage without weighing you down. Inseam 28".

Item #	Size Range	Inseam	Price
1309631	XS-2XL	Regular-Tall	\$45.00



NEW



**Women's Freedom
Logo Favorite
Hoodie**

Loose, ultra soft cotton blended fleece. Sweat-wicking material keep you warm and dry.

Item #	Size Range	Price
1332413	XS-2XL	\$50.00

- Black
- Steel
- Light Heather

Safety Supplies

There's nothing more important than keeping you and your crew safe on the job. Whether you're spraying crops, lugging loads of rocks or sod, or sanitizing a workspace with powerful cleaners, Gempler's has the right protective gear. Maybe all you need is a few pair of Nitrile Gloves, but if your job calls for a full chemical resistant suit plus a face shield and overboots, we've got that too. Call us 1-800-382-8473 and we'll help you get the right gear.



NEW
DeWalt® Bluetooth Earmuff
231668 on pg. 16



NEW
HONEYWELL UVEX® Avatar
Safety Eyewear
231338 on pg. 43



NEW
HONEYWELL NORTH®
Full Face Respirator
RU65001L on pg. 39

GEMPLER'S®

Honeywell

SHOWA

TOP BRANDS

3M

DU PONT®

ELVEX®
DELTA PLUS PARTNER

MOLDEX®

DEWALT®

Personal Protective Clothing & Equipment ... 23-82
First Aid & Emergency Response..... 83-91
Chemical Storage & Handling92-95

Signs, Labels & Traffic Control 96-106
Worker Safety & Compliance,
WPS Resources107-109



OUR FORMULA:

- Softer and more elastic
- Reduces hand fatigue
- Strong and durable

YOUR PROTECTION:

- 4 mil = Medium-Duty
- 8 mil = Heavy-Duty
- 12 mil = Extra Heavy-Duty

GEMPLER'S Disposable Nitrile Gloves

Nitrile tears when punctured, so you know if the glove integrity has been compromised. Ambidextrous. Specify size: S (8), M (9), L (10), XL (11) or 2XL (12).

NOTE: To obtain your glove size, use a tape measure to find the circumference of the knuckle area of your hand. This measurement, in inches, is your glove size. If the measurement is 10", specify 10 or Large.

Item #	Length	Thickness	Qty./Pkg.	Powdered	Container Type	Price
198253	9-1/2"	4 mil	100	No	Box	\$10.99
198249	9-1/2"	8 mil	50	No	Box	\$14.49
229997	12"	12 mil	250	No	Bag	\$145.99
229996	12"	12 mil	250	No	Bucket	\$150.99
229995	12"	12 mil	50	No	Box	\$32.99
198255	9-1/2"	4 mil	500	No	Bag	\$53.99
198258	9-1/2"	4 mil	500	Yes	Bag	\$54.99
198254	9-1/2"	4 mil	500	No	Bucket	\$59.99
198247	9-1/2"	8 mil	250	No	Bag	\$68.99
198252	9-1/2"	8 mil	250	Yes	Bucket	\$69.99
198248	9-1/2"	8 mil	250	No	Bucket	\$74.99



SHOWA N-DEX® Powdered Nitrile Gloves

Chemical and tear resistant

Ambidextrous, 100% nitrile gloves provide tactical sensitivity, comfort and dexterity. Lightly powdered to give you a cool, comfortable fit that goes on easy. Rolled cuff. Specify size: S (6-7), M (7-8), L (8-9), XL (9-10) or 2XL (10-11).

NOTE: These gloves are snug fitting; if in doubt, order next size larger.

Item #	Length	Thickness	Qty./Pkg.	Price
B7005	9-1/2"	4 mil	100	\$15.99
G8005	9-1/2"	8 mil	50	\$16.99



SHOWA Powder-Free Nitrile Gloves

These gloves give you the protection you need at an affordable price. Textured grip and rolled cuff. Specify size: S (6-7), M (7-8), L (8-9), XL (9-10) or 2XL (10-11).

Item #	Length	Qty./Pkg.	Thickness	Price
144166	9-1/2"	100	4 mil	\$11.99
181905	9-1/2"	50	8 mil	\$15.99



Kimberly-Clark PROFESSIONAL Powder-Free Nitrile-Xtra Exam Gloves

Nitrile polymer protects against dirty jobs and blood-borne pathogens. Latex and powder free with a beaded cuff and textured fingertips. Meet NFPA 1999-2008 standards. Specify size: XS-XL.

Item #	Length	Thickness	Qty./Pkg.	Price
105325	12"	6 mil	50	\$16.99
105325	12"	6 mil	50	\$16.99
105325	12"	6 mil	50	\$16.99
105325	12"	6 mil	50	\$16.99
105325	12"	6 mil	50	\$16.99
925125	9-1/2"	6 mil	100	\$18.99



Ansell Powder-Free Nitrile Exam Gloves

Bright orange color makes hands more visible to others while working around machinery. Also simplify compliance checks. Textured fingertips provide a firm grip. Powder and latex free. Rolled cuff for easy on/off. Approved for medical use. Specify size: S-2XL.

Item #	Length	Thickness	Qty./Pkg.	Price
156521	10-1/2"	5 mil	100	\$16.99



Powder-Free Nitrile Exam Gloves with Aloe

Undetectable inner coating of aloe helps keeps hands healthy

Skin-protecting aloe on the inside helps prevent dry, chapped hands, allowing you to work more comfortably longer. Superior chemical and puncture resistance. Latex-free (contains no natural rubber). Rolled cuff for easy on/off. Approved for medical use. Specify size: S-XL.

Item #	Length	Thickness	Qty./Pkg.	Price
86686	9-1/2"	5 mil	100	\$20.29



Biodegradable Powder-Free Nitrile Gloves

Revolutionary Eco Best Technology® is composed of organic materials that accelerate the biodegradation of nitrile in biologically active landfills. Ideal for a variety of applications including agriculture, automotive and landscaping. No natural rubber latex proteins. Feature a second-skin fit and feel, rolled cuff and smooth grip. Ambidextrous. Specify size: XS-2XL.

Item #	Price
230140	\$11.99
230139	\$11.99



Orange Powder-Free Nitrile Gloves

Fish-scale pattern provides superior grip

Feature NitrShield® with Grippaz™ Technology. Designed to cover a broad spectrum of industrial uses. Specify size: S-2XL.

Item #	Length	Thickness	Qty./Pkg.	Price
230035S	9-1/2"	6 mil	100	\$15.99
230035XL	9-1/2"	6 mil	100	\$15.99
230035XXL	9-1/2"	6 mil	100	\$15.99
230035L	9-1/2"	6 mil	100	\$15.99
230035M	9-1/2"	6 mil	100	\$15.99



Touch N' Tuff Nitrile Gloves

Disposable gloves combine the strength and chemical resistance of 100% nitrile with a "looser", more comfortable fit. Gloves are ambidextrous and have no natural proteins that may lead to allergic reactions. FDA accepted. Specify size: S (6.5-7), M (7.5-8), L (8.5-9) or XL (9.5-10).

Item #	Length	Thickness	Qty./Pkg.	Powdered	Price
AE555	9-1/2"	5 mil	100	Yes	\$15.99
AE666	9-1/2"	5 mil	100	No	\$18.99



Powder-Free Neoprene Gloves

Greater puncture resistance than latex

Single use gloves are highly resistant to acids, bases and alcohols and provide good chemical splash resistance. Protects workers from Type I allergies and are a great alternative to natural rubber latex. Textured fingertips for a secure grip. Specify size: S (7), M (8), L (9) or XL (10).

Item #	Length	Thickness	Qty./Pkg.	Price
138453	9-1/2"	5 mil	100	\$17.99
138454	11"	5 mil	100	\$22.99



Steel, Magnetic Glove Box Dispenser

Conveniently keep boxed gloves within easy reach

Two powerful magnets let you attach this handy steel dispenser to the side of your tool box, crew truck and other metal surfaces. Screw slots are also provided for mounting on walls and other non-metal surfaces. Dispenser features three springs that can be fully adjusted to fit either a 50- or 100-count glove box. 10"H x 5.75"W x 4"D.

Item #	Price
110010	\$26.99



GEMPLER'S Powdered Latex Gloves

Known for comfort, fit and protection

Industrial-grade gloves provide an excellent sense of touch, sensitivity and dexterity. They offer superior protection and flexibility while resisting tears and punctures. Smooth surface on the fingertips and palm for increased sensitivity. Rolled cuffs and lightly powdered for easy on/off. Ambidextrous. Specify size: S (8), M (9), L (10) or XL (11).

Item #	Length	Thickness	Container Type	Qty. / Pkg.	Price
198235	9-1/2"	5 mil	Box	100	\$12.19
198234	9-1/2"	5 mil	Bag	500	\$56.99
198236	9-1/2"	5 mil	Bucket	500	\$61.99



GEMPLER'S Industrial-Grade Powdered Vinyl Gloves

Latex-free and conform to your hands

Lightweight, comfortable vinyl gloves are powdered for easy donning. Provide exceptional fit and comfort. Each glove fits either hand. Made without natural rubber proteins to prevent allergic reactions (material is FDA and USDA accepted). Specify size: S (8), M (9), L (10) or XL (11).

Item #	Length	Thickness	Container Type	Qty. / Pkg.	Price
198238	10"	5 mil	Box	100	\$10.19
198240	10"	5 mil	Bag	500	\$40.69
198239	10"	5 mil	Bucket	500	\$47.19



“Tough enough to use over and over yet cheap enough to pitch and use a clean pair!”
– johnb



GEMPLER'S Best Selling Nitrile Gloves

Extra-thick premium glove with excellent dexterity

100% nitrile gloves provide excellent protection for handling most agricultural chemicals, solvents, acids and caustics. Nitrile resists snags, punctures, abrasions and cuts better than other glove polymers. Nonslip grip makes wet or slippery work easier, while an ergonomic shape enhances fit and comfort. Individually bagged pairs. Unlined gloves can be washed and reused and are for use with pesticides having labels referring to **Category A, C, E or F** on the EPA Chemical Resistance Category Selection Chart. Specify size: S (8), M (9), L (10) or XL (11).

Item #	Thickness	Lining	Length	Size	Pr./Pkg.	Price
727G	15 mil	Unlined	13"	XS-XL	1	\$2.99
12778	15 mil	Unlined	13"	S-XL	12	\$32.89
10212	15 mil	Unlined	19"	S-XL	36/Box	\$89.99
4082K	22 mil	Unlined	26"	L-XL	1	\$10.79
230352	15 mil	Flock	13"	S-XL	12	\$23.99

▲ WARNING: Cancer - www.P65Warnings.gov



Powder-Free Latex Gloves

These E-Grip textured latex exam gloves are made using a proprietary online chlorination process that minimizes water-soluble proteins in order to reduce your risk of allergic reactions and skin irritations. Beaded cuff for easy donning. Micro-textured finish enhances gripping power and tactile sensitivity. Nonsterile, ambidextrous and approved for medical use. Specify size: S-XL.

Item #	Length	Thickness	Qty./Pkg.	Price
86688	9-1/2"	5 mil	100	\$12.29



Derma Free™ Powder-Free Vinyl Gloves

Medical examination and food handling gloves

With 5.9-mil palms and 8.7-mil fingers, these gloves are thicker than other vinyl gloves for added protection without sacrificing tactile sensitivity. Ambidextrous, with a beaded cuff. USDA accepted for food handling. Specify size: S-XL.

Item #	Length	Thickness	Qty./Pkg.	Price
121954	9"	5.9 mil	100	\$10.99



Powder-Free Extra-Long Poly Gloves

Shoulder-length polyethylene gloves

Clear, disposable gloves feature an elastic band at the end to help hold the sleeve up. Built with strength and sensitivity in mind. Ambidextrous. One size fits most.

Item #	Length	Thickness	Qty./Pkg.	Price
175091	35"	1.25 mil	100	\$18.49



Disposable Cotton Glove Liners, Dozen Pair

Glove liners are worn inside rubber/chemical gloves to absorb perspiration. 100% cotton lisle for strength and durability. Unhemmed and reversible.

Item #	Size Range	Gender	Price
229930	M-L	Female	\$6.99



Biodegradable Nitrile Gloves

Revolutionary Eco Best Technology® allows complete decomposition in landfills, helping you do your part for the environment. Protect against solvents and acids. Textured grip on fingers/palm makes wet jobs and small parts handling easier. Specify size: S (7), M (8), L (9), XL (10) or 2XL (11).

Item #	Length	Thickness	Lining	Price
--------	--------	-----------	--------	-------



Chemical-Resistant Nitrile Gloves

Gloves feature superior resistance to snags, cuts, punctures and cuts without sacrificing dexterity or comfort. Textured grip makes assembling small oily parts a cinch. Flocked lining reduces moisture and adds comfort. Meet CFR 21, parts 170-199 NFPA 1992, ANSI/ISEA 105-2005, EN 388 (1101), EN 388 (3002), CE, ASTM. Specify size: 7-11.

Item #	Lining	Length	Thickness	Price
214439	Flock	13"	15 mil	\$3.79



AlphaTec® Lined Nitrile Gloves

Chemical-resistant gloves have a unique grip design for sure handling and better control with less fatigue. Flexible nitrile polymer provides excellent dexterity with a comfortable liner. Unique lining reduces sweat buildup inside the gloves for greater comfort and performance. Two-layered coating, with a superior nitrile film provides advanced chemical protection.

Item #	Lining	Length	Thickness	Price
225548	AquaDri	12"	26 mil	\$2.48
225549	AquaDri	15"	31 mil	\$5.77



Nitri-Solve® Nitrile Gloves

Top choice for chemical protection and flexibility

These interlock knit-lined nitrile gloves provide the comfort and protection you need from a variety of solvents, oils and acids. The rough-finish texture increases gripping power in the oiliest and wettest applications. Specify size: 9-11.

Item #	Length	Thickness	Price
122040	14"	30 mil	\$4.99



Nitrile Gloves

Protection without all the bulk

Liquidproof gloves extend up arm to provide excellent chemical protection. Lightweight design, plus a unique, rough texture for superior grip on oily, wet or dry objects. Pinked cuff. Knit lined for comfort. Specify size: S (7), M (8), L (9), XL (10) or 2XL (11).

Item #	Size Range	Length	Thickness	Price
225913	7-8	12"	22 mil	\$5.62
225913	9	12"	22 mil	\$7.49



Neoprene-Dipped Latex Gloves

Blue neoprene coating identifies wear-through

Unique glove offers the chemical resistance and durability of neoprene with the dexterity of a natural rubber latex glove. Yellow rubber latex under glove is double dipped in blue neoprene to reinforce the hand area and provide greater chemical resistance. Glove is worn out when the yellow shows through the blue neoprene coating. Specify size: S (7), M (8), L (9) or XL (10).

Item #	Length	Thickness	Qty./Pkg.	Price
230221	12"	28 mil	12 pr.	\$21.74



SHOWA Chloro-Flex™ Neoprene Gloves

Chloroflex - Premium quality neoprene provides superior protection from a wide range of oils and chemicals. Flock lining absorbs perspiration to keep your hands comfortable and allows for easy on/off. Pre-formed to the curvature of your hand for a better fit. **Chloroflex II** - Heavyweight neoprene provides extra protection against agricultural chemicals, oils, acids, resins, alcohols, caustics and other petroleum-based materials. Specify size: for 10344 S (7), M (8), L (9) or XL (10); for 54273: M (9), L (10) or XL (11).

Item #	Length	Thickness	Price
54273	18"	30 mil	\$15.79
10344	13"	24 mil	\$6.99



SHOWA Heavyweight Neoprene Work Gloves

Heavy-duty neoprene bonded to a supported cotton for protection from acids, anhydrous ammonia, oils, greases, caustics and many solvents. Flexible, durable and washable. Gauntlet cuff. May be cut to custom length. Size Large (10) only.

Item #	Thickness	Lining	Length	Price
35506	30 mil	Cotton	16"	\$13.49
152484	30 mil	Cotton	31"	\$49.99
NCG	30 mil	Cotton	12"	\$9.79



Honeywell NORTH Unlined Butyl Gloves

For certain high-toxicity pesticides, fumigants and anhydrous ammonia

Good dexterity and broad-spectrum ag chemical protection. Unlined, with a rough finish. For use with pesticides having labels that refer to Category A, B, C, D or F on the EPA's Chemical Resistance Category Selection Chart. Specify size: S (8), M (9), L (10) or XL (11).

Item #	Size Range	Length	Thickness	Price
14971	10	11"	16 mil	\$24.22
14971	8-11	11"	16 mil	\$28.49

FEATURES:

- More space inside mask for less restriction and better communication
- Larger filtering surface reduces breathing resistance
- Exhalation valve gets rid of hot and moist air faster
- Respirator material is easy to mold to your facial contours for a secure fit



"I love it that these masks come in different sizes. They work great."

- ralph-altmaier



GEMPLER'S N95 Particulate Respirator

Exhalation valve keeps you cool

Comfortable, best fitting respirator features more open space between you and the mask to relieve that "closed-in" feeling, making communication easy. Outside has a large filtering surface, reducing your breathing resistance. Exhalation valve allows exhaled air to escape quickly, keeping you cool and comfortable. Soft nose cushion and formable noseband give you a comfortable and secure fit. NIOSH approved to trap 95% of non-oil based particulates. Medium fits 70% of men. NIOSH Approval No. TC-84A-3745. Specify size: S (Red), M (Green), L (Blue).

Item #	Qty./Pkg.	Price
GR50	10	\$27.99



N95 Respirator

Provides excellent protection when grinding, sanding, sweeping or working other dusty jobs

Soft, flexible cloth head straps are 1"W to keep the respirator securely in place. Dual exhalation valves reduce eyewear fogging and that "closed in" feeling. Soft foam nose pad with comfortable, protective cloth layer. NIOSH Approval No. No. TC-84A-4638.

Item #	Qty./Pkg.	Price
175097	10	\$25.49



N95 Comfort Fit Respirator (CFR)

Combines a reusable facepiece with a pre-formed, disposable N95 filter to provide an excellent seal against your face

Unlike traditional N95 respirators, the filter does not come in contact with the face, protecting it from sweat and moisture. Simply unsnap the tabs on both sides of the mask, pull filter cover up and place new filter in position. Built-in exhalation valve and adjustable harness that allows you to hang the CFR from your neck. Includes one N95 filter. Specify size: S (women & young adults), M or L.

Item #	Description	Qty./Pkg.	Price
G10857	Respirator	1	\$17.49
G10857	Respirator	1	\$17.49
G10857	Respirator	1	\$17.49
10860	N95 Replacement Filters	20	\$21.49



Honeywell Nuisance Dust Mask

Basic protection against nontoxic dust, pollen and dander

This mask may be economical but it features an adjustable nose bridge that gives you the fit you need for protection against nuisance-level, nontoxic dusts. Ideal for use in the agriculture, construction and forestry industries.

NOTE: This respirator is not NIOSH approved.

Item #	Qty./Pkg.	Price
218698	50	\$8.32



MOLDEX® 2300 N95 Respirators

Dura-Mesh® inner/outer maintains mask shape

Mesh shell extends the service life up to 5X that of conventional respirators. Central exhalation valve allows hot, moist, exhaled air to escape from within the respirator, greatly improving wearer comfort. Flame retardants are added to decrease flammability of shell. NIOSH Approval No. TC-84A-0328.

Item #	Qty./Pkg.	Price
10776	5	\$19.79
2300M2	10	\$31.99
49843	10	\$31.99



MOLDEX® 2200 N95 Respirators

Low-cost respirator has a molded Dura-Mesh support that's built around the filter to resist collapse in hot, humid workplaces. Nosepiece is self-supported, without a metal nose band, and has a soft nose flange. Smooth rubber straps need no pre-stretching, will not irritate the neck or catch on hair. Certified under NIOSH 42CFR84 to have a filter efficiency level of 95% or greater against particulate aerosols free of oil. Approval No. TC-84A-0327. Model 2201N95 is designed to fit smaller faces. Approval No. TC-84A-2438.

Item #	Qty./Pkg.	Size	Model No.	Price
2200M2	20	M/L	2200N95	\$22.99
49842	20	S	2201N95	\$23.99



MOLDEX® Dirt Dawgs N95 Respirators

Moldex Dirt Dawgs N95 Masks stay fresh and comfortable, even in the hottest conditions

DuarMesh shell prevents them from collapsing in hot and humid environments—a great value for use on quick jobs. Contouring nose bridge seals securely without pinching and the softspun lining is comfortable against the face. Certified under NIOSH 42CFR84 to have a minimum filter efficiency of 95% or greater for non-oil based particulates. Approval No. TC-84A-3167. Size M/L.

Item #	Qty./Pkg.	Price
133349	20	\$21.99



MOLDEX® 2400 N95 Plus Nuisance Organic Vapor Respirator

The Moldex 2400 N95 Respirator keeps you breathing easy in cool comfort

Ideal for nuisance-level vapors from pollutants or fuel. Interior thin layer of charcoal removes these and other nuisance-level odors. Dura-Mesh outer shell retains its shape under hot, humid conditions. As you breathe out, air is quickly expelled through the exhalation valve, keeping you cooler and more comfortable. Approval No. TC-84A-0883. Size M/L.

Item #	Qty./Pkg.	Price
2400X2	10	\$52.99



MOLDEX® 2730 N100 Handystrap® Respirator

Filters more particles (like lead, cadmium and arsenic) than N95s

Protects against hantavirus. Dura-Mesh® shell allows this respirator to stand up to hot and humid conditions. HandyStrap system allows mask to hang around your neck when not in use. Exhalation valve, stretch-cloth straps and Softspun® lining. Approval No. TC-84A-3143.

Item #	Qty./Pkg.	Safety Supplies: Size	Price
G10855	5	S	\$45.79
10854	5	M/L	\$45.99



3M 8210/8110 N95 Dust/Mist Respirators

Protects against irritating dust and harmful mists

Certified under NIOSH 42CFR84 to have a minimum filter efficiency level of 95% or greater against dusts and other non-oil particulates. 47424 fits smaller faces. 8210/8110S Approval No. TC-84A-0007. 8210V NIOSH Approval No. TC-84A-5410.

Item #	Qty./Pkg.	Exhalation Valve	Price
214530	10	Yes	\$16.99
47424	20	No	\$22.19
8210	20	No	\$22.39



3M 8293 P100 Particulate Respirator

Great for oil-based pesticides

Disposable P100 has Advanced Electret Filter Media and stands up to oil-based pesticides when the label specifies a TC-21C or TC-84A respirator or a respirator protective against particulates. Highest efficiency available in a particulate respirator. Adjustable straps and 3M Cool Flow exhalation valve ensure comfort. Sold individually. NIOSH Approval No. TC-84A-2561.

Item #	Price
8293	\$14.59



3M 8200 N95 Particulate Respirator

Great for sweeping, sanding or working in dusty environments

Protects as you work in dusty environments for short periods of time. Two-strap design with dual-point attachment. Adjustable nose clip and comfortable nose foam reduce eyewear fogging and allow for a more custom fit. NIOSH approved to have a 95% filtering efficiency against non-oil based particulates. Approval number TC-84A-1289-03.

Item #	Qty./Pkg.	Price
162354	20	\$13.59



3M 8271 P95 Particulate Respirator

Protect yourself against dust, non-oil and oil-based mists

Breathe freely in the dustiest conditions with this respirator. Features Advanced Electret Filter Media, plus an internal face seal that fits comfortably across a variety of face sizes. Compliant with NIOSH 42CFR84. Approval No. TC-84A-1166.

Item #	Qty./Pkg.	Price
8271	10	\$41.59



3M 8511 N95 Particulate Respirator

M-shaped nose clip offers a better fit

Advanced Electret Filter Media traps small particles and makes breathing easier. Use for dusts produced while handling dry fertilizer in livestock barns and shelters, haying, grinding feeds, combining or baling. Protects against hantavirus. Certified under NIOSH 42CFR84. Approval No. TC-84A-1299.

NOTE: This respirator is not resistant to oils.

Item #	Qty./Pkg.	Price
8511N	10	\$25.99

227942

TOUGH-DUTY NEOPRENE DUST MASK

- Forms to facial contours for maximum comfort and filtration.
- Keeps skin ideal temperature in cold weather.
- Constructed out of durable neoprene.
- Great for low intensity activities.
- Wind Resistant.

Black Natural Silver

227946

Black Mesh Yellow Mesh
Gray Mesh Orange Mesh

AZ INDUSTRIES Environmental Dust Masks

More comfortable than traditional dust masks

Dust/particulate masks feature a cool-exhalation valve system that removes moisture and keeps you filtered all out, letting you breathe more comfortably. Masks include one Active Carbon filter. Additional filters must be purchased separately below.

Tough-Duty Neoprene – General-purpose mask made from neoprene for a superior fit. Hook-and-loop closure system. Offers excellent cold-weather protection. Specify color and size (Fig. 2).

Lightweight Mesh – Quite breathable, keeping your face cooler in warm conditions. Specify color and size (Fig. 2).

Replacement Filters each have two layers and have been laboratory tested for trapping particulates down to 0.5 microns in size. Specify color (Fig. 2).

Active Carbon – Standard filter is 99% effective against low-intensity fumes and odors.

HEPA – High-efficiency particulate air filter is 99% effective against particulates when no fumes or odors are present. 40% more breathability than the Active Carbon filter.

HEPA with Active Carbon – Premium filter combines qualities of the Active Carbon and HEPA filters for protection against particulates, fumes and odors. **NOTE: SZ Masks and Filters are not NIOSH approved.**

Item #	Description	Qty./Pkg	Price
227942	Tough-Duty Neoprene	1	\$81.29
227946	Lightweight Mesh	1	\$35.00
Replacement Filters			
227943	Active Carbon	3	\$7.59
227944	HEPA	3	\$10.79
227945	HEPA/Active Carbon	3	\$13.99



88001 Half-Mask Respirator

Specifically designed to accommodate hard-to-fit users. Includes three unique features making it adaptable to almost any facial structure. Wraparound profile forms to the user's face, while the facepiece pleats guide the mask towards face. Triple flange provides sealing security for greater freedom of movement. Size M/L. NIOSH 42 CFR 84.

Item #	Price
RU88001ML	\$41.70



Honeywell 7700 Premium Half-Mask Respirator

Soft silicone facepiece

Dual-elasticity headstraps and flexible facepiece provide you with a secure fit. Wide contoured sealing area features variable thickness--this allows the optimal amount of seal where it's needed most without sacrificing your respirator's fit. May be adapted to PAPR or supplied air. Specify size: S, M (fits 70% of men) or L.

NOTE: Cartridges and pre-filters sold separately.

Item #	Price
7210	\$31.99



3M Disposable P95 Organic Vapor Respirator

For "one-time" or limited-use applications

Features a rubber facepiece that is lighter than conventional dual-cartridge respirators. Simply throw the respirator away once the cartridges are used up. Includes respirator assembly, organic vapor cartridges, P95 pre-filters, retainers and instructions. Approval No. TC-23C-860. Extend the life of your respirator by replacing the P95 pre-filters (Item # 218681, sold separately). Specify size: S-L.

NOTE: Not to be used for fumigants (unless allowed on label) or paints containing isocyanate.

Item #	Price
10164	\$28.99



elipse Compact Respirators

Fit the contours of your face

Two of the lightest respirators on the market. Ergonomic design provides maximum visibility to wearers and can safely be worn with goggles, helmets and hearing protection. Soft, flexible thermoplastic elastomer facepiece is comfortable to wear for extended periods. Hypoallergenic, latex- and silicone-free. Half-mask design. Include two HESPA® filters. NIOSH approved. Protects against dust particles, metal fumes, mists and nuisance vapors. 99.97% effective. Specify respirator size: S/M or M/L.

Item #	Description	NIOSH Approval No.	Price
--------	-------------	--------------------	-------



3M FF-400 Ultimate FX Full-Face Respirator

Keep your lungs clean and your vision clear

Respirator gives you a wide field of view for excellent peripheral vision. NIOSH approved. 3M Scotchguard Protector keeps the facepiece clear by causing liquids to bead up on the surface for easy removal—simply wipe away with a dry cloth. Soft silicone nose cup and face seal along with a comfort cradle that positions the respirator more snugly. Six-strap harness. Specify size: S, M (fits 80% of population) or L.

NOTE: Cartridges and filters not included. Respirator uses same cartridges and filters as 3M 6000 Series.

Item #	Size Range	Price
162555	S	\$228.52
162555	M-L	\$304.69



3M 7500 Series Half-Mask Respirator

Dual-mode head harness drops down when not in use

More comfortable and durable than the 7000 Series Respirator. Unique head harness design adjusts easily so you have the option of wearing the respirator in traditional (when in use) or drop-down (when not in use) mode. NIOSH approved. Specify size: S, M (fits 80% of population) or L.

NOTE: Cartridges and filters not included.

Item #	Description	Price
G10861	Half-Mask Respirator	\$42.99
G10861	Half-Mask Respirator	\$42.99
G10861	Half-Mask Respirator	\$42.99
10872	Replacement Inhalation Valve	\$5.49
10873	Replacement Exhalation Valve	\$5.79



ALLEGRO Respirator Wipe Pads

Sanitize and hygienically freshen respirator facepieces that are uncomfortable or "stale"

These Respirator Wipe Pads have a long shelf life. 15% alcohol. Dispenser box of 100 individually wrapped pads.

Item #	Description	Qty./Pkg.	Price
24268	Canister	220	\$14.99
AMW50	Dispenser Box	100	\$15.99



ALLEGRO Irritant Smoke Fit Test Kit

Includes materials needed to perform OSHA-accepted, qualitative fit testing of respirators. Includes instruction manual, record form, six irritant smoke tubes, tip breaker and aspirator bulb—all packed into a carrying pouch with hook-and-loop closure. When fit testing, make sure employee is wearing a respirator with a HEPA or "100" type filter.

NOTE: Not for use under a respirator fit testing hood. Note: not for sale in (AL,GA).

Item #	Description	HM	Price
SMK50	Repl. Tubes (Pkg. of 6)	▲	\$33.99
FT50	Complete Fit Test Kit	▲	\$72.99

▲ Requires special handling due to DOT regulations. Additional shipping charges will apply. Cannot be shipped by air.

6000 Series Full-Face and Half-Mask Respirators

Lightweight and low maintenance Full-Face Respirator – Has a lightweight, balanced design and includes a large, field-coated lens for a wide view. Adjustable head strap with four-point rear suspension provides extra comfort. Cool Flow™ modulation valve minimizes heat and moisture. Soft silicone face seal. *Specify size 1, 2, 3, 4, 5, 6, 7, 8, 9, 10, 11, 12, 13, 14, 15, 16, 17, 18, 19, 20, 21, 22, 23, 24, 25, 26, 27, 28, 29, 30, 31, 32, 33, 34, 35, 36, 37, 38, 39, 40, 41, 42, 43, 44, 45, 46, 47, 48, 49, 50, 51, 52, 53, 54, 55, 56, 57, 58, 59, 60, 61, 62, 63, 64, 65, 66, 67, 68, 69, 70, 71, 72, 73, 74, 75, 76, 77, 78, 79, 80, 81, 82, 83, 84, 85, 86, 87, 88, 89, 90, 91, 92, 93, 94, 95, 96, 97, 98, 99, 100.*

Half-Mask Respirator – A low-profile facepiece provides better visibility and increased comfort with safety cover. *Specify size 1, 2, 3, 4, 5, 6, 7, 8, 9, 10, 11, 12, 13, 14, 15, 16, 17, 18, 19, 20, 21, 22, 23, 24, 25, 26, 27, 28, 29, 30, 31, 32, 33, 34, 35, 36, 37, 38, 39, 40, 41, 42, 43, 44, 45, 46, 47, 48, 49, 50, 51, 52, 53, 54, 55, 56, 57, 58, 59, 60, 61, 62, 63, 64, 65, 66, 67, 68, 69, 70, 71, 72, 73, 74, 75, 76, 77, 78, 79, 80, 81, 82, 83, 84, 85, 86, 87, 88, 89, 90, 91, 92, 93, 94, 95, 96, 97, 98, 99, 100.*

Cartridges and filters not included—order separately (see below).

Item #	Description	Price
6700	Full-Face	\$168.99
G10705	Half-Mask	\$16.59



6000, FF-400 & 7500 Series Half-Mask & Full-Face Cartridges

Item #	Description	Cartridge Type	NIOSH Approval No.	Qty./Pkg.	Price
G60921	Pesticide vapor (except fumigants, unless allowed on label), paint vapors (including paints containing isocyanates when cartridge change-out schedule is in place, according to NIOSH approval) and organic vapors, particulates	OV, P100	TC23C/84A	2	\$29.19
G60923	Acid gas/organic vapor (for dry-docking live-stock buildings); chlorine, hydrogen chloride, sulphur dioxide, particulates	OV, AG, P100	TC23C/84A	2	\$29.19
G60924	Ammونيا/ammonia (from livestock confinement); methylamine, particulates	AM, AM, P100	TC23C/84A	2	\$35.39
G60926	Multi-gas/vapor: organic vapors (including fumigants and paint spray), chlorine gas, disinfectants; ammonia/ammonia and animal confinement; sulphur dioxide, chlorine dioxide and methylamine; hydrogen fluoride and formaldehyde; particulates	OV, CL, PK, SD, HG, HS, CD, FM, AM, MA, P100	TC23C/84A	2	\$32.29
125757	Methyl bromide P100/organic vapors	OV, AG, P100	TC23C/84A	2	\$42.99
37154	P100 particulate filter (replaces H13A under new NIOSH standards)	P100	TC-84A	12	\$62.39
2027	P100 for pesticide particulate filter with moisture/organic vapor layer for odor flow profile for under-wireless helmets	P100 Substrate Level OV	TC-84A	2	\$11.99
10365	Organic vapor, pesticide vapors (insecticides, herbicides, fungicides, but not fumigants unless allowed on label), paint spraying (including paints containing isocyanates when cartridge change-out schedule is in place according to NIOSH approval) and organic vapors; use particulate filter too if spraying material	OV	TC23C	2	\$16.59
38030	N95 particulate filter for dusts, mists and fumes that don't contain oil	N95	TC-84A	10	\$16.79
216681	Reserve for N95 Filter			2	\$5.99

IMPORTANT WARNING! Exposure to all PM respirators. A respirator must be properly selected based on the air contaminant posing and also on the user's medical condition. It must be properly fitted and used in accordance with all manufacturer's instructions and use limitations.



Respirator not included

Respirator Storage Bag

For longer cartridge life and to protect your respirator from contamination. Use this heavy-duty, 10 mil, 14" x 10" elastic bag. Bag zipper locks for positive closure. Cleaning instructions for respirator are printed on bag.

Item #	Price
16558	\$6.79



Bitrex™ Fit Testing Kit

Ensure proper fit of your respirators

Provide employees with OSHA-compliant, qualitative fit testing for 125 respirators. Kit includes QuikFit™ Syntex™ food, twin-reinforced Bitrex™ aged, Bitrex™ bitter taste, which makes it more difficult for the worker to breathe. Bitter solutions are available in disposable glass ampoules to make pouring solution into a nebulizer easier and reduce the chance of contamination.

Item #	Description	Qty./Pkg.	Price
2041	Fit Test Kit	1	\$151.79
67872-1	1mg/100 Solution	10	\$16.79
67872-2	1mg/1000 Solution	6	\$16.79





NEW

Honeywell **54001 Full-Face Respirator**

The best value you can find in a full facepiece. Quality and attention to detail come together in an economically priced mask. Standard features include a nose cup and wide field of vision. The 5400 easily converts to a PAPR or Supplied Air respirator. Size M/L. NOTE: Cartridges and filters not included.

Item #	Price
54001	\$127.51



NEW

Honeywell **65001 Full Face Respirator**

Comfort for your workers - and your budget. The North RU6500 silicone full facepiece provides all day comfort at a great price. Size Large.

Item #	Price
RU65001L	\$165.66



NEW

Honeywell **760008 Full-Face Respirator**

Double flange sealing area made from medical-grade silicone for a comfortable fit and optimum facepiece to face seal. Other features include wide field of vision, five-strap harness and chin support. Size M/L.

Item #	Price
760008A	\$275.84



NEW

Honeywell **ER5000 5-Minute Escape Breathing Apparatus**

Every second counts. That's why Honeywell designed an advanced emergency Escape Breathing Apparatus that's so easy to use, it can be donned and functioning in seconds. Five-minute, high-flow duration.

Item #	Price
975638	\$686.88



NEW

Honeywell **PAPR System, Belt-Mounted**

Engineered to be ergonomic, efficient and effortless to get workers on the job faster and keep them comfortable and productive. The PA700 is a belt mounted, powered air purifying respirator platform from Honeywell Industrial Safety.

Item #	Price
PA701HE	\$1,198.50



NEW

Honeywell **PA111 Primair 100 Bibbed Hood Assembly**

Includes one loose fitting head cover and several hoods that can be used with the CA200 Series PAPR and the CF1000 Series CF-SAR. The manifold directs air over lens to reduce fogging. Triple adjustment headgear for a comfortable fit.

Item #	Price
PA111	\$76.11



MOLDEX® 7000 Series Half-Mask Respirator

Superior protection and all-day comfort make this respirator an industry favorite

Extra-wide comfortable sealing area. Plus, low-profile compact design allows a wide field of vision while wearing welding helmets and safety glasses. Adjustable head cradle has contoured neck buckles for a custom fit. Mask drops down around your neck when not in use. Specify size: S, M (fits 80% of population) or L.

NOTE: Cartridges and filters are not included.

Item #	Price
185608L	\$14.99
185608S	\$14.99
185608M	\$14.99



MOLDEX® Pre-Assembled Half-Mask Respirator Kits

Ultra-lightweight, durable and economical respirator

Half-mask facepiece has a low-profile, angled cartridge placement, with fewer parts for a wider field of vision. 100% PVC-Free® construction. Specify size: S, M or L. **Oil-Free Paint Spray/Pesticide Respirator Kit**—Includes (2) OV cartridges, (10) N95 pre-filters and (2) retainers. NIOSH approved for organic vapors.

Multi-Gas/Vapor Respirator Kit with SMART® Cartridge – Single cartridge takes the place of up to five gas/vapor cartridges, greatly reducing the chance of cartridge misuse. NIOSH approved for organic vapors, ammonia, methylamine, chlorine, hydrogen chloride, sulfur dioxide, chlorine dioxide, hydrogen fluoride, formaldehyde and hydrogen sulfide.

Item #	Description	Price
228128	Oil-Free Paint Spray/Pesticides Respirator Kit	\$35.99



KASCO K80S-T8 Air Flow Indicator

Use this device to check the condition of your filters and battery before wearing your helmet. You will know whether or not your battery needs to be charged or your filters need to be changed by watching the movement of the ball within the clear tube. For use with Kasco's T8 helmet only. Need more options?

Item #	Description	HM	Price
185994	K80S-T8 Unit	▲	\$1,219.00
147764	T8 Airflow Indicator		\$55.79

▲ Requires special handling due to DOT regulations. Additional shipping charges will apply. Cannot be shipped by air.



KASCO K80S T9 12V-Powered Pesticide Helmet

Runs on your vehicle's 12V electrical system

Low-cost, lightweight, powered air-purifying helmet is perfect for someone who sprays in orchards or on tractors not equipped with cabs. Air is drawn through two organic vapor/HEPA filters at a rate of 6.4 cfm. Polyurethane-coated, fiberglass helmet features a flip-up visor and adjustable headband. System comes complete with helmet, 6'L power cord, power socket, two pesticide filters, instruction manual and breathing tube. NIOSH Approval No. TC-23C-1562.

WARNING: Do not use Kasco helmets with fumigants unless allowed by fumigant's label. Do not use them in manure pits, silos or any atmosphere where oxygen may be less than 19.5%.

Item #	Description	Price
147765	T9 Airflow Indicator	\$55.99
031363	K80S-T9 Unit	\$829.99



Kasco® Prof 88 Dust Helmet

Cooler than half-mask or full-face respirators

Comfortable protection against dusts, mists, molds and fumes. 12V unit includes a tough, fiberglass helmet with two built-in blowers, batteries, charger and two high-efficiency (HEPA) dust/mist filters, which draw in air at 6.8 cfm. Operate the unit off your tractor's 12V battery/power source (requires 126005 power cord) or by using the battery and charger. Helmet-mounted filters provide greater mobility. NIOSH Approval No. TC-21C-633. NOTE: This helmet will accept the ZA2P3 pesticide filters (sold separately). When fitted with these pesticide (organic vapor) filters, this product is not NIOSH approved and therefore would not be approved for respiratory protection from pesticides requiring organic vapor protection.

WARNING: Do not use KASCO helmets with fumigants unless allowed by fumigant's label. Do not use KASCO helmets in manure pits, silos or any atmosphere where oxygen may be less than 19.5%.

Item #	Description	Price
PROF88	Dust Helmet	\$1,139.00
126005	Power Cord	\$119.99

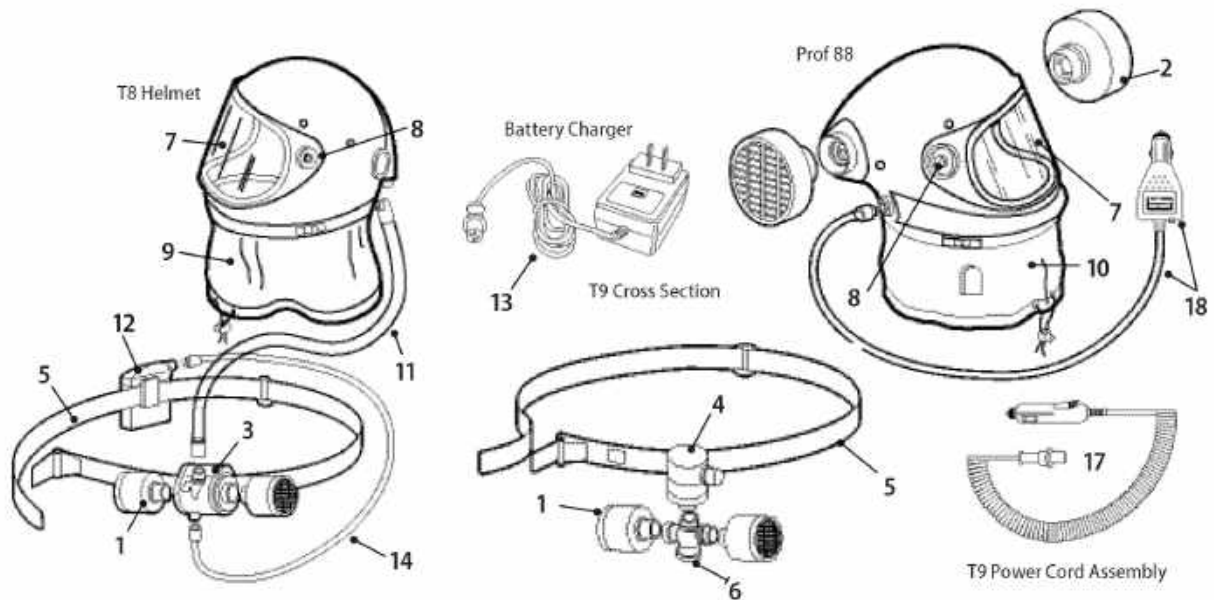

KASCO REPLACEMENT PARTS

Item #	Key	Description	Parts Fit On	Price
060119-1	1	ZA2P3 Pesticide/HEPA Filter (sold individually)	T8 & T9	\$73.99
130708	NS*	Pre-Filter for ZA2P3 Pesticide Filter (sold individually & requires retainer)	T8 & T9	\$9.49
070506-1	NS*	Pre-Filter Retainer (sold individually)	T8 & T9	\$6.79
060120-1	2	ZP3 HEPA Filter for Dusts/Mists/Fumes (sold individually)	Prof 88	\$39.29
060125-1	NS*	ZA2P3 Pesticide/Particulate Filter NOT NIOSH APPROVED	Prof 88	\$71.29
0303038-1	3	T8 Blower	T8	\$435.99
0303006-1	4	T9 Blower	T9	\$359.99
0307021-1	5	Waist Belt	T8 & T9	\$34.99
0309023-1	6	3-way Filter Connector (attaches filter to blower)	T9	\$16.29
10233	NS*	K805 helmet (includes collar, suspension and faceshield)	T8 & T9	\$619.99
0203003-1	NS*	Head Suspension for K805 Helmet	T8 & T9	\$23.29
190305	7	Clear Faceshield	T8, T9, Prof 88	\$78.99
190306	7	Tinted faceshield	T8, T9, Prof 88	\$139.99
1903007	NS*	Tear-Off Faceshield Protector	T8, T9, Prof 88	\$6.79
1502003	8	Washer for Faceshield	T8, T9, Prof 88	\$6.79
190108	NS*	Replacement Faceshield Screw	T8, T9, Prof 88	\$5.99
10782	NS*	Faceshield Gasket	T8, T9, Prof 88	\$12.49
030601-1	9	Blue Replacement Collar with Hardware for K805 Helmet	T8 & T9	\$78.99
0309078-1	10	Blue Replacement Collar with Hardware for Prof 88 Helmet	Prof 88	\$89.99
0309109-1	11	Breathing Tube	T8 & T9	\$59.99
185993	12	T-8 Battery	T8	\$284.99
0605002-1	NS*	4A Fuse for T8 Battery	T8	\$2.39
126004	13	T8 Battery Charger	T8	\$238.99
0605003-1	NS*	1.6S Fuse for T8 Battery Charger	T8	\$2.39
0201011-1	NS*	Prof 88 battery	Prof 88	\$205.99
134473	NS*	Prof 88 Battery Charger	Prof 88	\$254.99
0605001-1	NS*	1A Fuse for Prof 88 Battery Charger	Prof 88	\$2.39
0309081-1	14	T8 Electrical Cable (attaches battery to blower)	T8	\$47.99
0309118-1	NS*	SP8 Power Cord Assembly (includes plug and cable - transfers power from tractor to blower)	T8	\$192.99
109812	17	SP9 Power Cord Assembly (includes plug and cable - transfers power from tractor to blower)	T9	\$83.99
030909-1	NS*	Optional 12'L Power Cord	T9, Prof 88	\$86.99
134265	NS*	3A Fuse for T9 Cable Plug	T9	\$2.99
126005	18	Power Cord	Prof 88	\$119.99
10784	NS*	Rivet Kit (includes washer, stud and stud receptor)	T8, T9, Prof 88	\$2.49
0309002-1	NS*	Breathing Tube	T1, T4, T5, T7	\$38.29
0309057-1	NS*	Old Blower or Charger to New Battery (4-prong round male end, 2-prong slotted female end)	T8 & T9	\$43.79
139196	NS*	Exhaust Check Valve	T8 & T9	\$9.99

NS* = Not shown



HydroShield Anti-fog Coating
HydroShield anti-fog coating is permanently bonded to the lens, featuring dual-action properties that keep lenses clear up to 60X longer than our next best coating.

HYDROPHILIC ACTION
Moisture is **ABSORBED** by the lens.

HYDROPHOBIC ACTION
Water droplets form and are **REPELLED** to the sides of the lens.

NEW
Honeywell

Uvex® Avatar Safety Eyewear

Uvex Avatar is stylish and protective eyewear with technology allowing customization, premium anti-fog coating and anti-scratch hard coating. It also wraps around, indirect venting, wrap-around temples, and MMT-MULTI-MATERIAL TECHNOLOGY** at every touch-point for maximum all-day comfort and is customized fit for every facial profile.

Item #	Lens Color	Frame Color	Price
231338	Clear	Blue	\$10.99
231338	Clear	Black	\$10.99
231338	Clear	Red	\$10.99
231338	Gray	Blue	\$10.99
231338	Gray	Black	\$10.99
231338	Gray	Red	\$10.99



NEW
Honeywell

Uvex Livewire-Sealed Eyewear

Delivers the fit, performance and protection required in extreme environments. Protects workers against intense wind, sun, dirt, dust and debris, as well as high heat and humidity. For long-lasting, anti-fog performance. Precision, fit-tested, form-fitted frame defies debris.

Item #	Lens Color	Price
231340	Clear	\$17.99
231340	Gray	\$17.99



Tectonic Safety Glasses

Flexible temples and a custom, secure fit

Eliminate the weight and discomfort associated with some safety eyewear without sacrificing fit and comfort. Each pair weighs just 1 oz. and has flexible temples that keep your glasses in place. Features a comfort-molded nosepiece and wraparound nine-base curved lens with excellent side protection. Block 99.9% of harmful UV rays. Meets ANSI Z87.1-2010 standards.

Item #	Anti Fog	Lens Color	Price
214616	No	Gray	\$4.29
218775	Yes	Clear	\$4.79
214616	No	Silver Mirror	\$4.99



A400 Series Safety Glasses

A real favorite of crews because of light weight

Offer great wraparound protection and are extremely lightweight for maximum comfort. Lenses and frames made of 100% impact-resistant polycarbonate. All lens tints have a scratch-resistant coating. Meets ANSI Z87.1-2010 High impact standards.

Item #	Lens Color	Price
124239	Clear	\$5.49
124242	Amber	\$6.29
124241	Gray	\$6.49
124243	Silver Mirror	\$8.49
124244	Indoor/Outdoor Mirror	\$8.49



Uvex Hypershock™ Safety Glasses with Clear Frame

Uvex Hypershock Safety Glasses feature a sleek and sporty design

Honeywell Uvex Hypershock Safety Glasses have an aggressive, sports-inspired design and full frame for a look the crew will love. Safety glasses feature a soft, molded nosepiece and temple inserts that provide a secure fit, even when you work up a sweat. Scratch-resistant hardcoat lenses. Clear frame. Meets ANSI Z87.1-2010.

Item #	Lens Color	Price
225585	Red Mirror	\$10.79
225587		\$9.49
225581	Clear	\$9.49



Genesis® Safety Glasses

Increased comfort, protection and style

These safety glasses withstand impact energies 7x greater than ANSI velocity tests to meet the military test regimen. SCT is designed to absorb select wavelengths of light into the polycarbonate lens. Brown frame. Exceed ANSI Z87.1+ High Impact Standards. Mil V0 ballistic test for impact.

Item #	Lens Color	Price
10436	Clear	\$11.79
10444	SCT-Reflect 50	\$13.79
G10443	Gold Mirror	\$13.99



ELVEX Xenon Safety Glasses

Weigh just 0.8 oz. and are an excellent fit for small faces. Stylish and comfortable design. Block out 99.9% of UV rays. Meet ANSI Z87.1-2010 (Z87+) and CE EN-166.

Item #	Lens Coating	Lens Color	Price
198282	Hardcoat	Amber	\$3.29
198283	Hardcoat	Blue	\$3.49
198278	Hardcoat	Clear	\$3.79
198280	Hardcoat	Indoor/Outdoor	\$3.79
198279	Hardcoat	Gray	\$3.79
198281	Hardcoat	Blue Mirror	\$3.99
198284	Antifog	Clear	\$3.99
198285	Antifog	Gray	\$4.29



ELVEX XTS Wraparound Safety Glasses

Stylish eye protection

Impact-resistant with a sturdy, comfortable nylon frame. Polycarbonate lenses protect from ultra violet rays. Meet ANSI Z87.1-2010.

Item #	Frame Color	Lens Color	Price
162358			\$37.99
SG24	Dark Gray	Gray	\$6.49
SG24	Red	Mirror	\$6.79
SG24	Dark Gray	Clear	\$6.79



ELVEX TTS Safety Glasses

The style of sunglasses with exceptional protection

Comfortable and sleekly styled. Close fit gives the wearer exceptional protection from flying debris. Lightweight glasses are made of 100% polycarbonate material. Hard-coated for scratch resistance. Meet ANSI Z87.1-2010.

Item #	Lens Color	Price
G10494	Clear	\$3.79
10497	Gray	\$3.99
G10496	Indoor/Outdoor	\$4.79

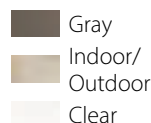



ELVEX SphereX Ultimate Safety Glasses

Unique lens/frame ventilation help prevent fogging, dual-lens construction allows excellent optics. Sleek wraparound design. Temples adjust to four different lengths for a correct fit. 99.9% UV protection. Ballistic Vo rated and tested at 7x the energy of ANSI high-velocity test. Meets Z87.1-2010.

Item #	Lens Color	Price
222274	Indoor/Outdoor	\$6.79
222275	Silver Mirror	\$6.79
222272	Clear	\$6.99
222273	Gray	\$7.49

-  Clear
-  Gray
-  Indoor/Outdoor
-  Silver Mirror



ELVEX Acer™ Safety Glasses

Comfortable and lightweight with a unique frame with a classy look. Wraparound, hard-coated polycarbonate lens with floating design and soft rubber nose bridge offers protection, comfort and scratch resistance. Meet ANSI Z871-2010 High Impact Standard.

Item #	Lens Color	Price
151443	Clear	\$4.79
151445	Gray	\$4.99
151447	Indoor/Outdoor	\$5.79
151448	Silver Mirror	\$5.79
151444	Clear	\$5.79
151446	Gray	\$6.29

-  Clear
-  Indoor/Outdoor
-  Silver Mirror
-  Gray



ELVEX Sonoma™ Safety Glasses

Sonoma Clear Safety Glasses combine superior protection with classic style

Be safe and comfortable in Sonoma safety glasses. Each offers a great fit for a variety of face shapes and sizes. Brown lens provides the same light attenuation (18 to 20%) as Elvex's standard NCB gray lens. Brown, gold mirror and light brown lenses have blue-blocking properties that reduce outdoor haze and increase contrast. The darker the lens, the greater protection it has. Meets ANSI A87.1 (Z87+) Specify Lens Color.

Item #	Lens Color	Price
187150	Gray	\$28.99
187146	Clear	\$6.79
187147	Light Brown	\$6.79
187149	Gold Mirror	\$7.29





carhartt Industrial Safety Glasses

Lightweight for all-day comfort and protection

Wraparound coverage without sacrificing comfort or style. Lightweight, frameless design. 100% polycarbonate, scratch-resistant lenses block 99% of harmful UV rays.

Item #	Lens Color	Price
222341	Clear	\$4.79
222345	Gray	\$5.29
222342	Clear	\$5.79
222343	Bronze	\$5.79
222346	Gray	\$5.99



-  Clear
-  Gray
-  Bronze



carhartt Carbondale™ Industrial Safety Glasses

Ergonomic wraparound two-tone frame. Flexible, dual-injected temples and rubber nosepiece. 100% polycarbonate, scratch-resistant lenses block 99% of harmful UV rays. Meets ANSI Z87.1 high-impact standards.

Item #	Lens Color	Price
222347	Clear	\$10.49
222349	Bronze	\$11.49
222350	Gray	\$11.49
222348	Clear	\$11.49
222351	Gray	\$11.99



-  Clear
-  Bronze
-  Gray



carhartt Spokane™ Industrial Safety Glasses

Lightweight half frame design. Flexible rubber nosepiece. 100% polycarbonate lenses block 99% of harmful UV rays. Meets ANSI Z87.1 high-impact and CAN/CSA Z94.3-07 standards.

Item #	Lens Color	Price
222352	Clear	\$11.99
222354	Gray	\$12.79
222353	Bronze	\$12.79

-  Gray
-  Clear
-  Bronze



ELVEX Wraparound Safety Bifocals

Stylish, lightweight and comfortable

Transparent gray polycarbonate frame with a soft rubber nose bridge and rubber-tipped temples for long-wearing comfort. Meet ANSI Z87.1-2010.

Item #	Lens Color	Price
125731	Clear	\$12.99

- Clear
- Gray



ELVEX Go-Specs™ Bifocal Safety Glasses

Bifocal safety glasses protect against dust, UV rays and impact. Impact-resistant molded lens features SuperCoat™ antifog coating clears your vision in humidity or when you break a sweat. Filter out 99.9% of UVA, UVB and UVC rays. Meet ANSI Z87.1-2010(+).

Item #	Lens Color	Price
214346	Gray	\$15.79



UVEX Polysafe WPS-Standard Safety Glasses

Meet WPS requirements for protective eyewear when working with pesticides. May wear over most prescription eyewear and with respiratory protection. Lenses block 99% of UV rays. Coated to resist scratches and many chemicals. Meet ANSI Z87.1-2010 and CSA Z94.3 standards.

Item #	Lens Color	Price
126073	Gray	\$3.99
126074	Clear	\$3.99

- Gray
- Clear



UVEX Uvex Astrospec® Safety Glasses

The Uvex Astrospec 3000 Standard Safety Glasses feature adjustable temples. Replaceable, single-piece, impact-resistant polycarbonate lens. Uvextreme AF anti-fog coating. Meets ANSI Z87.1-2010 Specify Lens Color.

Item #	Lens Color	Price
S2500C	Clear	\$12.99
S535C	Clear	\$5.79
S536C	Gray	\$6.79
S561	Clear	\$7.29
S562C	Gray	\$7.79
S1169C	Clear	\$8.79
S1179C	Gray	\$9.79



ELVEX Go-Specs™ Eyewear

These Go-Specs Safety Glasses are lightweight like safety glasses, but sealed like goggles

Blocks 99% of harmful UVA, UVB and UVC rays. Go-Specs: feature 1.8mm-thick lens with a base 6 curvature. Meets ANSI Z87.1-2010. Go-Specs II: 2.3mm thick lens with a 9.5 base curvature. Meet ANSI Z87+ High Impact. CE EN-166. Anti-fog coating.

Item #	Lens Color	Price
162255	Clear	\$10.79
162376	Gray	\$10.79
184561	Clear	\$11.79
184562	Gray	\$11.79



ELVEX Pacaya Lyviz™ Safety Glasses

Safety glasses with oil-resistant lenses keep your view clear

Safety glasses have a oleophobic and hydrophobic polycarbonate lens coating that makes water droplets roll off and oil, paints and dirt wipe right off. Lenses stay clearer, longer and block 99% of harmful UV rays. Adjustable nylon arms and integrated nosepiece add comfort. Meet ANSI Z87.1-2003.

Item #	Lens Color	Price
230006	Smoke	\$10.79
229488	Clear	\$10.99



UVEX Seismic™ Sealed Convertible Eyewear

Features eight-base wraparound and provides excellent peripheral vision and protection when working. Includes removable temples, headband and cushioned subframe. Meets ANSI Z87.1-2010. CSA Z94.3 when foam subframe is used.

Item #	Frame Color	Lens Color	Price
174244	Black	Clear	\$21.79
174247	Black	Amber	\$22.49
174246	Black	Espresso	\$22.99
174250	Metallic Blue	Clear	\$23.49
174248	Black	SCT-Reflect 50	\$23.49
174251	Metallic Blue	Amber	\$23.99



carhartt Carthage™ Sealed Safety Glasses/Goggles

Interchangeable temples and strap let you quickly convert from conventional safety glasses to sealed goggles. Stylish, ergonomic frame. Fog prevention. 100% polycarbonate, scratch-resistant lenses help reduce glare and block 99% of harmful UV rays. Meets ANSI Z87.1 high-impact and CAN/CSA Z94.3-07 standards.

Item #	Lens Color	Price
222355	Clear	\$19.99
222356	Bronze	\$21.49
222357	Gray	\$21.49



Uvex Tirade™ Sealed Safety Glasses

Sealed safety glasses keep out the wind, debris and glare

These safety glasses are sealed to protect against wind, airborne debris etc. Include strap for converting safety glasses into goggles! Block 99% of harmful UV rays. Anti-Fog coating. Cushioned headband-style temples. Meet ANSI Z87.1-2010 and CSA Z94.3 standards.

Item #	Lens Color	Price
225767	Amber	\$7.99
225765	Clear	\$8.49
225766	Gray	\$8.49
225769	SCT-Reflect 50	\$9.29
225768	Silver Mirror	\$9.29



A800 Series Safety Glasses

Shield eyes with a sporty wraparound style

Nine-base wraparound polycarbonate lens is available with optional Fog-Ban anti-fog coating, nonslip rubber nose bridge and unique padded temples for comfort. Blocks out 99% of harmful UV rays. Meets ANSI Z87.1-2010.

Item #	Lens Color	Price
225890	Gray	\$4.29
225894	Clear	\$4.29
225891	Amber	\$4.59
225895	Gray	\$4.79
225893	Indoor/Outdoor	\$6.29
225892	Blue Mirror	\$6.49



A900 Series Reader/Magnifier Safety Glasses

Safety glasses with magnification built right in

These magnifying safety glasses act great as "readers" in the field while also protecting your eyes. Sporty, eight-base wraparound polycarbonate clear lens has a scratch-resistant hardcoat finish. Nonslip rubber nose bridge and padded temples give you a comfortable fit. Black frame. Meet ANSI Z87.1-2010 and CSA Z94.3.

Item #	Price
225896	\$10.79
225897	\$10.79
225898	\$10.79



Uvex Protege® Safety Glasses

Safety glasses with proprietary Floating Lens™ design that increases flexibility and fit

These "featherweight" safety glasses weigh less than 1 oz. — so light you'll barely know you have them on. Wraparound brow expands to fit a number of face sizes and keeps the glasses securely on your face. Soft temple-tip pads and flexible nose pad "fingers" add comfort and reduce slippage. HydroShield™ antifog lens coating. Black frame. Meet ANSI Z87.1-2010 and CSA Z94.3. Meet military V7 ballistic test for impact.

Item #	Lens Color	Price
225902	Clear	\$7.49
225903	Gray	\$7.99



Indirect-Vented Splash Goggles

These goggles feature a fog-free, impact-resistant lens and a price that makes them easily replaceable when worn out.

Vinyl goggles provide good visibility through a fog-free, impact-resistant lens. Can be worn over prescription glasses, or with a half mask or disposable respirator. Adjustable rubber headband fits most head sizes. Goggles breathe through indirect vents, but still protect eyes from splashes. Meets ANSI Z87 + High Impact standard.

Item #	Price
10507	\$3.79



Fog-Free Splash Goggles

If you need the maximum protection against mist and accidental splashes, these are the goggles for you

These comfortable, lightweight and flexible vinyl goggles have convenient indirect vents that allow air to circulate and reduce fogging. These glasses give you the maximum protection against mist and ag chemicals. Meet ANSI Z87.1+ High Impact standard.

Item #	Price
GOG	\$8.79



Replacement Fog-free Lens for Sellstrom Chemical Splash Goggles

Replacement fog-free polycarbonate lens for indirect vent (Item # GOG) and non-vented (Item # G88113) chemical splash goggles. Meets ANSI Z87.1-2010.

Item #	Price
G22444	\$2.49
G84011	\$6.79
G88113	\$8.99



Classic Chemical Goggles

Comfortable protection for your eyes

Textured neoprene headband prevents slippage, and Uvextreme anti-fog lens coating keeps the clear lens clearer. Great impact protection. 99.9% of UV rays. Closed-vent design. Fit over most prescription glasses. Meet ANSI Z87.1-2003.

Item #	Price
211733	\$9.99



Monogoggle™ XTR™ Goggle/Shield Combo

Protect your face and eyes

Indirect ventilation and a polycarbonate shield to protect your face. The curved shield conforms to your face and can detach from the goggle for versatility. Use over prescription eyeglasses. Meets the ANSI Z87.1+ Impact Standard.

Item #	Price
--------	-------



Flex Seal Safety Goggles

With these Uvex Flex Seal Safety Goggles, the search for comfortable, over-the-glasses goggles is over!

Silicone frame provides an exceptionally tight seal on most facial profiles. Low-profile, polycarbonate lens, Uvextreme anti-fog coating. Indirect ventilation system minimizes fogging. Neoprene band. Replacement Lens available. Meets ANSI Z87.1-2003.

Item #	Frame Color	Lens Color	Price
124190	Navy	Gray	\$16.79
124188	Navy	Clear	\$16.99
143969	Gray	Clear	\$16.99
143970	Gray	Gray	\$16.99
124188			\$8.79



Visionaire™ Safety Goggles

These Elvex Visionaire Goggles won't leave you in a fog

Feature SuperCoat anti-fog treatment on both sides of the polycarbonate lens, as well as four large indirect ventilation slots to help reduce vision-clouding. The dual lens in these Elvex Visionaire Goggles provide excellent dust and splash protection as well as comfort in cold-weather work. Extra-wide elastic-fabric strap provides all day comfort while the wide contact points between the goggle and face give you an excellent fit. Complies with ANSI Z87.1-2010.

Item #	Price
148734	\$16.99



Carbonvision™ Dust/Splash Safety Goggles

Ultra-lightweight and comfortable, weighing just over 1.5 oz. Block 99.9% of harmful UV rays and protect against impacts. Low profile is ideal for wearing with disposable respirators and protective caps. Meets ANSI Z87.1-2010, CSA Z94.3.

Item #	Price
218881	\$15.79

- Clear
- Gray



Stealth Goggles

Great eye protection for chemical mixing, brush cutting or grinding

Sleek, wraparound styling dramatically improves peripheral vision. One-piece, impact-resistant polycarbonate lens. Spare lenses available. Uvextreme lens coating protects against fogging and scratches. Meets ANSI Z87.1-2010. Spare lenses sold separately.

Item #	Lens Color	Price
G97801	Clear	\$14.99
40518	Amber	\$16.99
G97802	Gray	\$16.99
G97804	Gray	\$7.79



saftstrom **Lightweight, Multipurpose Face Shield**

Protect your eyes and face from splashes and flying debris with this lightweight face shield

This free-floating, drop-down headgear holds a replaceable, 8"H x 12"W x 0.06"-thick, clear acetate window that protects your eyes and face from harmful splashes and flying debris. Sturdy, positive-lock headband fits all sizes. Top overhang prevents particles and liquids from entering from above. Meets ANSI Z87.1-2003 + High Impact standard.

Item #	Price
FSC	\$23.99



UVEX **Turboshield Wraparound Face Shields**

Just add a visor for comfortable protection while welding

The head-cushioning cradle provides 300% greater contact area than traditional suspensions to eliminate pressure points. Push button visor attachment and release. Shape provides 50% more chin coverage than competition. Visor sold separately. Meet ANSI Z87.1-2010.

Item #	Description	Price
225911	Uncoated Visor	\$14.79
225909	Ratchet Headgear	\$24.99



UVEX **Wraparound Face Shields**

Honeywell Uvex Face Shield is contoured for superior protection and visibility

Bionic Face Shield is extremely lightweight and features a contoured design for superior face protection and improved visibility. Ratcheting headgear fully adjusts the shield for a comfortable and secure fit. Soft, breathable headband keeps you cool and dry. Easy to replace faceshield. Meets ANSI Z87.1-2010. Replacement face shield windows (Item #124202 & 124204).

Item #	Price
124204	\$24.99
124200	\$37.99
124201	\$52.99
124202	\$9.99



3M **Replacement Chin Protector**

3M chin protector is a replacement part for Item # 212129.

Item #	Description	Price
212130	Clear Window Face Shield	\$11.99
212131	Repl. Chin Protector	\$12.49
212129	Headgear and Chin Protector	\$27.99



C-CLEAN Disposable Lens Cleaners

Convenient, portable canister with 100 pre-moistened wipes

Compact canister contains 100, 5" x 8" pre-moistened lens cleaning wipes that pull out for quick dispensing. The portable pop-up canister is ideal for storage in trucks and tool boxes. Wall-mountable box of Spray and Tissues contains 16-oz. pump bottle of silicone and alcohol-free solution, along with 1,200 low-tint tissues that dispense from the side of the box. Pre-Moistened Packets can be used anywhere. Towelettes are 5" x 8", 100 packets per box.

Item #	Description	Qty./Pkg.	Price
139309	Towlette Canister	100	\$11.49
10521	Pre-Moistened Packets	100	\$12.99
10526	Spray and Tissues	1200	\$13.99



Bausch + Lomb Sight Savers® Lens Cleaning Towelettes

The all-in-one cleansing wipe that cleans glasses without scratching, fogging or leaving annoying streaks

Pre-moistened towelettes clean glass or plastic-lensed safety glasses without leaving a static residue. Individually packaged, pre-folded towelettes come in a corrugated dispenser for quick and easy access. Each silicone-free towelette measures 8"L x 5"W.

NOTE: Not for use on contact lenses.

Item #	Price
25868	\$14.79



Type I and Type II Replacement Parts and Accessories

This hard-shell eyewear case keeps your safety glasses clean and protected

Hardshell case keeps eyewear protected and free of dirt or dust. Fully padded interior prevents scratches. Clamshell polyethylene design allows the cover to close and snap into place for secure storage. Handy clip attaches the case to your belt, hammer loop, tool pouch etc. Accommodates most safety glasses. 6-1/2"L x 2-1/2"W x 4"D.

Item #	Price
109616	\$9.79





Breakaway Safety Glass Retainers

Chums Breakaway Safety Glass Retainers for added safety

Breakaway retainers for safety glasses are recommended for machine operators or other hazardous environments where a breakaway is needed for safety. These Chums Breakaway Safety Glass Retainers attach easily to most frames and securely hold standard safety glasses to reduce loss or breakage. Original/Chumbo Retainers-- 100% fully adjustable to provide comfort and security. Original for standard frames, Chumbo for wider earpieces.

Item #	Description	Price
10528	Original Retainer	\$8.79
67917	Breakaway Retainer	\$9.79

-  Blue
-  Black
-  Red



Honeywell Eyesaline® Eyewash Station

This Honeywell Eyesaline® Eyewash Station is ideal for shop or field. Solution bottles are safety sealed and dated. Includes two 32-oz. eyesaline bottles. Refills of eyesaline solution are sold separately (Item # E508).

Item #	Size	Price
E608		\$11.99
E508		\$14.99
9789	16 oz.	\$32.49
E507	32 oz.	\$47.99



Eyesaline® Portable Eyewash Belt Pak, 16-oz. Bottle

This Portable Eyewash Belt Pak keeps you prepared in the event of a chemical spill

This Honeywell Eyesaline Portable Eyewash Belt Pak contains a solution to flush the skin and eyes in the event of a chemical spill. Convenient nylon belt case has a youch closure flap to keep bottle secure while you work. EPA's WPS requires that handlers have a 16-oz. (one pint) minimum of portable eyewash immediately available. Replacement bottle available (Item # E608, sold separately).

Item #	Price
109816	\$19.99



Honeywell Saline Concentrate

Use with any gravity-fed eyewash station

Buffered to the same pH as the human eye (7.4) this isotonic saline is designed to provide eye itigation without irritation. Inhibits bacteria growth for up to siz months. 70-oz size makes 5 gal. 180-oz size makes up to 16 gal.

Item #	Price
E509	\$42.99
10589	\$83.99



Honeywell Eyesaline® Eyewash Bottle

Replacement Honeywell Eyesaline® Eyewash Bottle for the Honeywell Emergency Eyewash Travel Kit

Refill Sterile Honeywell Eyesaline Eyewash Bottle for the Honeywell Emergency Eyewash Travel Kit (Item # 135790, sold separately).

Item #	Price
39468	\$3.49
39469	\$4.99
135790	\$53.99



Honeywell Water Additive

Preservative creates a buffered, saline eyewash solution that's suitable for 14 to 16 gal. of potable water for up to 120 days.

Item #	Size	Price
HS8	8 oz.	\$11.99



Bradley **Portable Eyewash Station**

Requires only 7 gallons of solution and is transportable to job locations

This Bradley portable eyewash station is easy to transport to job sites so you're always ready in an emergency. Assembly is fast and easy: Fill the tank, seal the tank opening with the liner/cap, place it on the pedestal (liner is punctured and releases solution into reservoir), close the eyewash tray and secure the clamps. Includes tank, pedestal, metal hanging bracket, three liners, eyewash sign and inspection tag. Meets ANSI Z358.1-2004. Keep the water in your eyewash station fresh for up to 120 days with , sold separately.

Item #	Price
122175	\$326.99



Bradley **Faucet-Mounted Eyewash Station**

Quickly turns your standard or gooseneck faucet into an emergency eyewash station

Attaches to any standard or gooseneck faucet (not included) and lets you easily switch between faucet use and emergency eyewash. The front pin allows you to keep the cold water supply pressurized at all times and activates the eyewash in an emergency, while the top pin allows you to operate your faucet. Heads are equipped with flow control to ensure a safe and steady water flow under varying pressure conditions. Meets ANSI Z358.1. SEI Certified.

Item #	Price
109424	\$84.99



Low-Profile Emergency Eyewash Station

The compact, portable size of this Emergency Eyewash Station makes it easy to take wherever you need it

Space-saving eyewash station meets OSHA's emergency eyewash requirements and is only 22"W x 14-1/2"H x 10-1/8". Tank has a built in handle for easy handling and wall mounting with the bracket (included). Holds 9 gallons of water and weighs 70 lbs when filled. The wide opening makes it easy to inspect, clean and fill with eye washing solution. Use with . Meets ANSI Z358.1 requirements.

Item #	Description	Price
121891	Eye Wash Station	\$219.99
222488	Preservative, Pkg of 4	\$62.99



Honeywell **Replacement Pull Strap for Porta-Stream® II Portable Eyewash Station**

Replacement Pull Strap for the Porta-Stream II Portable Eyewash Station

Replacement pull strap for the Porta-Stream II portable, 15-min. eyewash station (Item # E200).

Item #	Description	Price
10592	Replacement Pull Strap	\$24.99
E200	Eye wash station	\$279.99



Bradley  **Combination Eyewash And Drench Shower**

Halo Combination Eyewash and Drench Shower station provides the most effective washdown protection on the market

Halo eye/facewash stations and showers provide the most effective washdown protection on the market. SpinTec drench shower provides a spinning motion of water that provides an even spray pattern for superior full-body washdown. Eye/facewash bowls cover 85% of an average person's face, giving you up to 20% better coverage than competing models. Aquaduct self-draining design removes standing water from the spray head, reducing the risk of bacteria growth. Feature separate supply and waste pipes that prevent cross-contamination from the clean inlet and the wastewater. Meet ANSI Z358.1 standard as well as U.S. and European plumbing requirements.

NOTE: Dust covers only come with models that say dust cover on them.

Item #	Bowl Material	Price
181810	Stainless Steel	\$1,059.00
181811	Stainless Steel	\$1,129.00
181805	Plastic	\$799.99
181808	Stainless Steel	\$931.99
181807	Plastic	\$964.99



Bradley  **Wall Mount Eyewash**

Bradley Halo Wall Mount Eyewash Station ramps up workplace safety

Halo Wall Mount Eyewash features separate supply and waste pipes to eliminate cross-contamination. Redesigned dust covers (not featured on all models) keep the units clean and bright yellow color allows for easy recognition. Aquaduct™ self-draining design removes standing water from the spray head, reducing the risk of bacterial growth when not in use. Features an ergonomic hand activation paddle that's easy to reach from any direction. Meet ANSI Z358.1 standard as well as U.S. and European plumbing requirements.

NOTE: Dust covers only come with models that say dust cover on them.

Item #	Bowl Material	Price
181818	Plastic	\$315.99
181820	Stainless Steel	\$349.99
181819	Plastic	\$363.99
181823	Plastic	\$469.99
181821	Stainless Steel	\$524.99
181825	Stainless Steel	\$609.99



NEW

MOLDEX® EcoStation Plug Dispensers with Snap in Refills

Convenient, quick access and ease of use for more compliance. The refillable and recyclable EcoStation dispenser is easy on the hearing protection budget and easy on the environment. Each Starter Pack comes prefilled with 500 pairs of 33 NRR earplugs. Earplugs drop right into the palm of your hand so you don't have to worry about plugs falling on the floor or trays collecting dust and contaminants. Softies earplug refill pack item #6702.

Item #	Description	Price
6708	Meteors Refill	\$100.77
6705	Pura-Fit Starter Pack	\$104.29
6707	Meteors Starter Kit	\$105.82
6702	Softies Refill	\$77.28
6701	Softies Starter Kit	\$83.84
6704	SparkPlugs Refill	\$86.31
6703	SparkPlugs Starter Pack	\$91.36
6706	Pura-Fit Refill	\$99.23



NEW

MOLDEX® Alpha Reusable Earplugs

Innovative engineering and automation creates a superior reusable earplug at a very reasonable price. Alphas' high Noise Reduction Rating (NRR 27dB) provides protection for most noisy environments and these have been independently tested to ANSI S3.19-1974 by an independent, accredited laboratory, so users can be confident in the protection they are getting when worn properly. 100% PVC Packaging. Available to order end of January, 2020.

Item #	Type	Price
6430	Uncorded	\$124.00
6434	Unattached Cord w/ Case	\$144.00
6435	Corded w/Case	\$164.00



MOLDEX® SparkPlugs® Uncorded Earplugs

These Moldex SparkPlugs Earplugs are easy to insert and remove, plus super comfortable for all-day wear

Disposable non-allergenic earplugs are made from extra-soft and extra-lightweight foam. Random radiant colors increase compliance among workers. Tapered shape makes plugs easy to insert and remove and helps seal the ear canal gently and snugly without pressure.

Item #	NRR	Corded/Uncorded	Size	Pairs Per Package	Price
30403	33dB	Uncorded	Universal	200	\$36.99
30404	33dB	Corded	Universal	100	\$37.99



MOLDEX® Pura-Fit™ Earplugs, Corded

Get outstanding sound suppression in a soft, tapered and comfortable earplug

These disposable Moldex Pura-Fit Earplugs have a 33dB NRR, which is superior to most "muff" style hearing protection. Plugs are easy-to-see bright green. Corded style.

Item #	NRR	Corded/Uncorded	Size	Pairs Per Package	Price
6900M	33dB	Corded	Universal	100	\$38.99
6800M	33dB	Uncorded	Universal	200	\$39.99



FirmFit™ Uncorded Earplugs

Earplugs are some of the softest and most comfortable you'll find

Earplugs reduce expansion pressure on the ear canal by 29%, meaning your fit is much more comfortable. Require less pressure to roll down. Slow recovery rate gives you more time to properly insert into your ears. NRR 30 rating is suitable for medium-to-high noise environments. Orange color makes compliance checks easy. Specify corded or uncorded.

Item #	NRR	Corded/Uncorded	Size	Pairs Per Package	Price
225881	30dB	Uncorded	Universal	200	\$27.49
225882	30dB	Corded	Universal	100	\$30.99



MOLDEX® PlugStation® Dispenser with Earplugs

This convenient wall-mounted earplug dispenser keeps Moldex SparkPlugs earplugs dry and clean in dusty or wet work areas

This wall-mounting dispenser keeps earplugs dry and clean in dusty or wet work areas. Mount it on the wall in the office, shop or service truck. To operate, simply rotate the orange knob and an earplug will drop into your hand. Clear reservoir lets you keep an eye on inventory. To restock, simply remove the empty reservoir and slide a new one into the wall bracket.

Item #	NRR	Corded/Uncorded	Size	Pairs Per Package	Price
43059	33dB	Uncorded	Universal	250	\$44.99
6844M	33dB	Uncorded	Universal	250	\$52.99



MOLDEX® Mellows™ Foam Earplugs

Moldex Mellows feature extra-soft, extra-light foam and a smooth, tapered shape to fit easily and comfortably in your ear canal

Extra-soft foam with a smooth, smaller tapered shape to fit easily and comfortably in your ear canal. Individually bagged plugs are bright orange with a neon green cord (#185633 only) for quick and easy compliance checks. 100% PVC free with a non-irritating smooth surface.

Item #	Size	Style	Corded/Uncorded	Price
185633	Universal	Corded		\$18.74
185634	Universal		Uncorded	\$42.99
185635	Universal		Uncorded	\$81.99



Max and Max USA Earplugs

Maximum hearing protection with maximum comfort

The 33dB NRR of these ultra-soft foam earplugs is the highest available. Tapered shape and extremely soft foam make these plugs comfortable to wear and easy to set in place. Unique, soil-resistant, smooth outer skin stays clean and free of debris. Choose from corded or uncorded styles. Plugs are individually bagged in pairs.

Item #	NRR	Price
MAX6	33dB	\$14.99
MAX8	33dB	\$31.99
214379	33dB	\$31.99
MAX4	33dB	\$34.99
89127	33dB	\$34.99

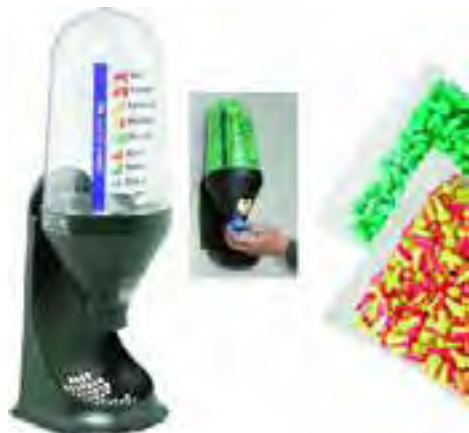

Max Lite® Refill Bag

Refill your Leight Source 400 Dispenser with the most comfortable earplug you've ever wear

Howard Leight Max Lite Refill Bag contains 200 pair of earplugs with a 30dB NRR. Use with the Leight Source 400 Dispenser (Item # 133303).

Item #	NRR	Corded/Uncorded	Pairs Per Package	Price
133305	30dB	Uncorded	200	\$26.99
133306	32dB	Uncorded	200	\$26.99
133303				\$27.99



Max Lite® Earplugs NRR 30

The unique shape of these Max Lite® Earplugs makes them the most comfortable ear protection you'll ever wear.

The lightweight, self-adjusting foam of these Max Lite® Earplugs ensures exceptional fit and all-day comfort. Bright green color makes for easy compliance checks.

Item #	NRR	Corded/Uncorded	Pairs Per Package	Price
16502	30dB	Corded	100	\$27.99
15251	30dB	Uncorded	200	\$27.99



HOWARD LEIGHT BY HONEYWELL Laser Lite® Uncorded Earplugs

Bright colors make these earplugs easily visible for compliance checks

Multicolor earplugs are not only fun-colored and comfortable, but also have good NRR. Non-irritating, non-allergenic, self-adjusting foam conforms to fit almost any ear canal. Magenta/Yellow. Individually bagged pairs.

Item #	NRR	Corded/Uncorded	Pairs Per Package	Price
LL30	32dB	Corded	100	\$27.99
LL1	32dB	Uncorded	200	\$30.99



MOLDEX® Jetz™ Reusable Earplugs

Moldex Jetz Earplugs feature triple-flange protection in a reusable style

These earplugs are 100% PVC-free and durable enough to be washed and reused. Triple-flange design offers NRR 27, and hi-vis green color allows for easy compliance checks. Plus, a unique grip at the end of each stem makes for easy insertion and removal, even when wearing gloves. Extremely soft material seals the ear canal. Specify corded or uncorded.

Item #	NRR	Pairs Per Package	Price
185630	27dB	50	\$48.99
185631	27dB	50	\$61.99



3M Skull Screws™ Earplugs

Protect your hearing with a simple twist

These E-A-R Skull Screws Uncorded Earplugs give you a modern new look for hearing protection. Metallic silver, screw-grip design doesn't need to be rolled before you wear them. Just push straight into the ear with a simple twist. NRR 30dB. Pkg. of 120 pair. Specify corded or uncorded.

Item #	NRR	Corded/Uncorded	Pairs Per Package	Price
143958	32dB	Uncorded	120	\$58.29
143959	30dB	Corded	120	\$82.19



Airsoft Reusable Earplugs with Vinyl Cord

Block noises and stay comfortable

These AirSoft four-flange design creates a better seal in your ear canal, greater protection and increased comfort for long-term wear. Internal fins create an interlocking, noise-blocking barrier within the air pocket, providing dependable noise reduction. Easy insertion and removal. 27db NRR.

Item #	NRR	Corded/Uncorded	Price
DELETE_3JLW7	27dB	Corded	\$11.99
DPASS	27dB	Corded	\$11.99
DPAS	27dB	Corded	\$129.99



3M Classic Earplugs

E-A-R Classic Uncorded Ear Plugs provide low-pressure comfort and superior noise reduction

The workhorse of foam earplugs; these are the most commonly used ear plugs in the world. Slow-recovery PVC foam gives you comfort and low pressure. Moisture-resistant, skin-safe foam is non-irritating. Easy to use, wall-mounting dispenser boxes contain individually packaged pairs.

Item #	NRR	Corded/Uncorded	Pairs Per Package	Price
124212	29dB	Uncorded		\$11.49
EAR998	29dB	Uncorded		\$35.39
10195	29dB	Corded	200	\$72.79



NEW

XTRA Noise-Isolating Hearing Protection Earbuds Black/Yellow

Bluetooth earplug headphones designed for extended use in the workshop and beyond. Sweat, water, and dust resistant with 27 NRR, 8 hour rechargeable battery, multi-function magnetic earbuds, and lightweight neckband.

Item #	Price
IT-02	\$74.99



NEW

XTRA Noise-Isolating Hearing Protection Earbuds Black

Bluetooth earplug headphones designed for extended use in the workshop and beyond. Sweat, water, and dust resistant with 27 NRR, 8 hour rechargeable battery, multi-function magnetic earbuds, and lightweight neckband.

Item #	Price
IT-07	\$74.99



NEW

FREE Noise-Isolating Hearing Protection Earbuds Black

Ultra-lightweight Bluetooth earplugs with True Wireless technology. Designed to reduce noise while sitting flush in your ears. Dust, sweat, and water resistant with all-day battery life, high fidelity aptX audio, and 22 NRR.

Item #	Price
IT-13	\$109.99



NEW

FREE Noise-Isolating Hearing Protection Earbuds Black/Green

Ultra-lightweight Bluetooth earplugs with True Wireless technology. Designed to reduce noise while sitting flush in your ears. Dust, sweat, and water resistant with all-day battery life, high fidelity aptX audio, and 22 NRR.

Item #	Price
IT-14	\$109.99



NEW



**Honeywell
VeriShield 100
Series Passive
Earmuffs**

Steel-wire construction with padded headband and precision micro adjustments designed for just the right fit around the ear. New unique memory foam combines denser and softer foam than previous models, for greater comfort and attenuation. Reduces squeezing pressure on the head and enhances comfort.

Item #	Price
231281	\$29.99



NEW



**Howard Leight
1035116-VS
VeriShield VS130N
Behind the Neck
Earmuffs**

Comfortably fits a wide range of head sizes. Ideal for workers with larger ears, or who wear hearing aids. Steel-wire construction with padded headband and precision micro adjustments designed for just the right fit around the ear. New unique memory foam that combines denser and softer foam than previous models, for greater comfort and attenuation.

Item #	Price
231283	\$29.99



**Howard Leight
1035100-VS
VeriShield Earmuff**

Featuring a baseplate chamber and high-tech non-woven layer, Honeywell's Air Flow Control technology controls how sound reaches the ear, ensuring optimum noise attenuation across all frequencies. Easy to use and integrate with Honeywell hard hats and face shields.

Item #	Price
231279	\$12.99



NEW



**Howard Leight
1035114-VS
VeriShield VS120N
Behind the Neck
Earmuffs**

Featuring a baseplate chamber and high-tech non-woven layer, Honeywell's Air Flow Control technology controls how sound reaches the ear, ensuring optimum noise attenuation across all frequencies. Easy to use and integrate with Honeywell hard hats and face shields. The attenuation level of each style is marked on the earmuff cup.

Item #	Price
231282	\$12.99



**Howard Leight
1011603 Thunder
T3 Helmet**

Designed with all-day comfort in mind. Thunder headband earmuffs feature a unique dual headband for better positioning and breathability, and a non-deforming outer headband that minimizes pressure on the head. Dielectric construction.

Item #	Price
231278	\$36.99



**Howard Leight
1010970 Thunder
T3 Noise Blocking
Earmuff**

Features patented Air Flow Control technology for optimal attenuation across all frequencies and also snap-in ear cushions for easy maintenance. Thunder headband earmuffs feature a unique dual headband for better positioning and breathability, and a non-deforming outer headband that minimizes pressure on the head.

Item #	Price
231277	\$29.99



Leightning® L3 Hi-Vis Earmuffs

Leightning L3 Hi-Vis Earmuffs not only protect your hearing, but also increase your visibility and safety on the jobsite

Wide, extra-long, softly padded headband is more comfortable than other and has a wire up/down slide adjustment to fit many head sizes. Soft, slow-recovery ear cushions provide a form-fitting seal. Pivoting head cups allow easy on/off. Soil-resistant vinyl-covered ear cushions. 30dB NRR. **Replacement Ear Cushion Kit:** includes one pair of ear cushions and one pair of foam inserts.

Item #	Price
105961	\$10.99
133336	\$30.99



Replacement Ear Cushion Kit for MaxiMuff™ earmuffs

Replacement Ear Cushion Kit for MaxiMuff earmuffs

Replacement ear cushion kit for use with the MaxiMuff™ earmuffs from Elvex (, sold separately). Soft sealing ear cushions are comfortable for long periods of wear.

Item #	Description	Price
10183	Earmuff	\$17.99
10729	Replacement Ear Cushion Kit	\$7.59



GEMPLERS Hearing Band

Curved band keeps pods from touching dirty surfaces

Soft, ergonomic pods with a lightweight, curved band. Tested according to ANSI S3.19-1974 standard. NRR 25dB. Includes one pair of replacement pods.

Item #	Price
229898	\$2.00



Viking™ Noise-Blocking Earmuffs

Howard Leight Viking Noise-Blocking Earmuffs give you better, more consistent sound reduction for the ultimate in hearing protection

Wear them over the head, behind the head or under the chin, letting you choose the position that is most comfortable. Patented Air Flow Control technology delivers optimal attenuation, reducing noise that can harm your hearing. The inner ventilated headband reduces pressure on the head and is more breathable in warm environments. Can be comfortably worn with other PPE, including hard hats, face shields, respirators and welding shields. Safe for use around electrical hazards. Meet ANSI S3.19-1974.

Item #	Price
214551	\$11.49
214552	\$19.99
214553	\$25.99



Sync™ AM/FM Radio Earmuffs

Protect your ears and feed your mind with these Howard Leight Sync Digital AM/FM Radio Earmuffs

Howard Leight Sync Digital AM/FM Radio Earmuffs give you high-quality sound with a lightweight, comfortable fit. Includes Airflow Control Technology with snap-in ear cushions. Radio has 10 presets and volume will not exceed 82dB. Enjoy digital AM/FM radio without the bulk and extra weight of other earmuffs. Bright Lime model has a reflective headband that glows when exposed to light. Includes 3.5mm audio input cable. 111-hr battery life on (2) AA batteries (included).

Item #	Price
198388	\$10.99
218734	\$89.99
218735	\$89.99

- Lime
- Black



ELVEX QuieTunes™ AM/FM Radio Earmuffs with Input Jack

Get high quality sound, great reception and all-day comfort at a low price

Extra-large tuning knob provides finer adjustments than smaller knobs and allows you to find the stations you want faster. All the adjustment controls, including the push-button AM/FM mode selector, are easily changed, even with a gloved hand. Head and ear cushions are soft and wide for a comfortable, low-pressure seal. Radio muffs operate up to 150 hr. on the (2) AA batteries (included) and the battery life is protected by an automatic 4-hr shutoff.

Item #	Price
151208	\$79.99
151277	\$99.99



ELVEX Wireless Sync Headset Earmuffs

Headset earmuffs allow you to operate machinery without the person you're talking to hearing!

Elvex Wireless Headset Earmuffs allow wireless sync-to-phone communication with the touch of a button. Protect hearing in noisy environments with a 22 NRRdB and still allow you to communicate with coworkers. Allows contact with other compatible devices up to 10' away. Input jack for your portable music player. Comfortable, foam-padded PVC headband, plus soft earcups. 4-hr. auto shut-off. Built-in USB charger port. Run on and include (2) AA alkaline batteries.

Item #	HM	Price
229486		\$179.99
229487		\$189.99
225879	▲	\$198.99

▲ Requires special handling due to DOT regulations. Additional shipping charges will apply. Cannot be shipped by air.



Sync™ Stereo Earmuffs

Block harmful noise while listening to music

Designed to provide NRR: 25 hearing protection with sound quality comparable to high-end stereo headphones. Volume Management Technology manages output volume from your portable MP3 player, smartphone or other personal listening device at 82dB. NRR of 25dB. No batteries required; simply plug into your portable device. Hygiene kit (sold separately) includes ear cushions and a dust cover.

Item #	Price
198387	\$39.99

WHY CHOOSE TYVEK®?

Excellent chemical resistance
 Lightweight, breathable, comfortable
 Catches gross particles, prevents contact
 Great reusability

APPLICATIONS:

- Handling acids, caustics or toxic products
- Handling fuel or oily liquids
- Cleanup work
- Multi-media work
- Paint spraying
- Food processing
- Oil and power handling
- Lead abatement
- Fiberglass manufacturing (winding and installation)
- Asbestos abatement



TYVEK® 400 COVERALLS

Lightweight, breathable customer favorite

Keep cooler while you work. Protect against splashes, plus hazardous particles like dust, some pesticides, asbestos and fiberglass. Low-cost and handy for dirty jobs such as machinery maintenance. Comfort-fit design and generous sizing in the sleeves and legs allow greater freedom of movement and reduces "tearing out" in critical areas. Sealed seams. Specify color from table.

Individuals		
Item #	Size	Price
214560	M-XL	\$8.29
	2XL-4XL	\$8.99
	5XL-7XL	\$9.99
214559	M-XL	\$7.49
	2XL-4XL	\$8.29
	5XL-7XL	\$9.29
214561	M-XL	\$8.49
	2XL-4XL	\$9.49
214558	M-XL	\$8.29
	2XL-4XL	\$9.29

Pack of 6		
Item #	Size	Price
181967	M-XL	\$48.99
	2XL-3XL	\$48.99
181966	M-XL	\$39.99
	2XL-3XL	\$44.99
181968	M-XL	\$44.99
	2XL-3XL	\$49.99
181969	M-XL	\$45.00
	2XL-3XL	\$51.99

Case of 25		
Item #	Size	Price
181971	M-2XL	\$165.99
	3XL-4XL	\$201.99
181970	M-XL	\$152.99
	5XL-4XL	\$187.99
181972	M-2XL	\$172.99
	3XL-5XL	\$205.99
181973	M-2XL	\$174.99
	3XL-4XL	\$209.99



TYVEK® 400 SHIRT AND PANTS
 Protective options when full-body coverage is not necessary
 Tyvek shirts and pants provide excellent balance of protection, durability and comfort. Ideal for applications that do not require the full-body coverage of a coverall. Applications include lead and asbestos abatement, environmental general maintenance positions, spray painting and general clean-up. Fresh, open, high-density polyethylene creates a unique, non-woven material offering protection against particles down to 10 micron in size. Colored shirt has front snap closures and open wrists. Pants have open ankles and an elastic waist for easy donning and removal.

Item #	Description	Size	Price
230036	Shirt	M-XL	\$5.99
		2XL-3XL	\$6.99
230037	Pants	M-XL	\$4.99
		2XL-3XL	\$5.99



UNISEX SAFETY COVERALL SIZING CHART

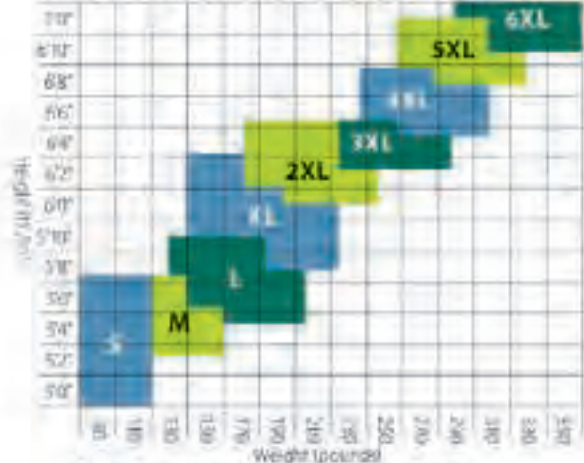

NOTE: This is a general reference guide for overall sizing.

WARNING: Tyvek® is not guaranteed to be waterproof and only provides limited splash/spill protection. There are environments and uses for which these coveralls, shirts and pants are unsuitable. It is the responsibility of the user to review available data and verify that the garment is appropriate for the intended use and meets all government and industry standards. Avoid open flame or excessive heat.



GEMPLERS General Purpose Coveralls

Protect yourself during the dirtiest jobs

SMS tri-laminate polypropylene is strong and durable yet offers outstanding comfort, breathability, softness and wearability. Provide barrier protection against particulates and are appropriate for situations with low to moderate liquid contact. Resist tearing and abrasion.

NOTE: Due to the thousands of pesticide formulations available today, it's impossible to determine if a particular garment protects against a specific chemical. Therefore, we recommend testing the clothing against the chemical before using.

Item #	Size Range	Qty./Pkg.	Price
165562	S-3XL	10	\$45.99
165564	S-3XL	10	\$48.99
165562	4XL-5XL	10	\$49.99
165564	4XL	10	\$51.99
165565	M-3XL	10	\$52.99
165565	4XL-5XL	10	\$56.99



DUPONT ProShield® 60 Coveralls

Get protection against non-hazardous dry particulates, light splashes, sprays and aerosols, while at the same time keeping cool

Light-duty protection is great for nonhazardous dry particulates, light splashes, sprays and aerosols. Made with a microporous film that is laminated to a spunbonded polypropylene substrate. 10-mil thick with serged seams. 26"L zippered opening allows easy on/off access. Specify Size: M-4XL. SURCHARGE NOTE: Sizes 3XL-4XL have a \$15 surcharge per pkg., which will be added at checkout.

WARNING: There are environments and uses for which these coveralls are unsuitable. It is the responsibility of the user to review available data to verify that the garment is appropriate for the intended use and meets all government and industry standards. Avoid open flame or intense heat.

NOTE: Due to the thousands of pesticide formulations available today, it's impossible to determine if a particular garment protects against a specific chemical. Therefore, we recommend testing the clothing against the chemical before using.



Item #	Size Range	Color	Qty./Pkg.	Price
218812	M-2XL	White	25	\$118.99
218813	M-2XL	White	25	\$129.99
218812	3XL	White	25	\$132.99
218813	3XL	White	25	\$145.99
182790	M-4XL	White	25	\$154.99
218815	M-2XL	White	25	\$159.99
218815	3XL	White	25	\$175.99



Kimberly Clark A20 Coveralls w Hood, Elastic Wrist & Ankle

Kimberly Clark A20 Coveralls With Hood, Elastic Wrist & Ankles are ideal general purpose coveralls. The Seamless front construction offers greater protection in high-exposure areas and the Rugged Reflex® design is 7-1/2 times less likely to rip. These coveralls have more chest room and longer body length for better fit. Zipper front. Elastic back, wrists and ankles. Hood provides protection for head and ears. Made from NFPA 99-compliant antistatic material. Serged seams. Pkg. of 24. Specify Men's size: M-2XL.

Item #	Safety Supplies: Color	Safety Supplies: Size	Price
218822	White	2XL	\$145.99
218820	Blue	2XL	\$154.99
218823		2XL	\$159.99
218819		L	\$189.99

-  Blue
-  White



Microporous Protective Clothing

Suit-up with splash and spray protection against "caution" rated pesticides

Light-duty, budget friendly protective clothing provides liquid spray/splash and dry particulate protection for many applications such as low-toxicity pesticide spraying and liquid fertilizer application. Breathable, microporous garments are cool to wear in hot/humid environments. Coveralls feature easy gliding, full-length zipper. White Color. Specify Size: S-5XL.

WARNING: There are environments and uses for which these coveralls are unsuitable. It is the responsibility of the user to review available data and verify that the garment is appropriate for the intended use and meets all government and industry standards. Avoid open flame or intense heat.

Item #	Size Range	Description	Price
148812	S-2XL	Coveralls	\$5.79
148812	3XL-4XL	Coveralls	\$6.79



GEMPLER'S Waterproof Chemical-Resistant Chaps

Gempler's Chaps protect against low-toxicity (Class III and IV) pesticides

Durable polyurethane/nylon is lightweight and resistant to tears, abrasions and chemicals. Remain flexible in extreme temperatures. Protects against low-toxicity (Class III and IV) pesticides. Fits thighs up to 28" in circumference. One size fits most.

Item #	Description	Price
G10211	Open Front	\$32.99
228116	Full Front	\$39.99



High Toxicity Butyl Rubber Pesticide Spray Chapps™

Quickly wrap these chaps around your legs to stay safe and protected during spraying or mixing applications

Chemical Spray Chapps are constructed of lightweight butyl rubber and offer excellent chemical resistance up to Class 1. Wrap around your entire leg and secure with hook and loop fasteners. Regular length is 29-1/2"L and accommodates a person 5' to 6' tall. Fits thighs up to a 26" around. Long length is 35"L and accommodates a person 6' tall and taller. 1.3-1.7 lb. One Pair.

Item #	Description	Price
130470	29-1/2" Regular Length	\$64.99



Spray Vest™ Backpack Sprayer Leakage Protection Vest With Mesh Front

A perfect companion for backpack sprayers - this vest is chemical-resistant and designed to keep you safe, comfortable, and cooler on hot days.

Spray Vest™ Backpack Sprayer Leakage Protection Vest features a mesh front to help keep you cooler on hot days and long spray jobs. The extra-long butyl rubber back panel and extended neck collar provides additional protection. One size fits most.

Item #	Description	Price
10570	Standard Vest	\$69.99
10571	Mesh-Front Vest	\$71.99



GEMPLERS Blue Poly-Coated Coveralls and Pants

The polyethylene coating on these Gempler's coveralls provides better splash/spray protection than standard Tyvek® material

Gempler's Poly-Coated Coveralls are lightweight with a zipper front for easy on/off. Open wrists and ankles keep you cooler. Fully cut to provide good freedom of movement and a comfortable fit over your work clothes. Ideal for use in publicly visible locations such as facility grounds, lawns, golf courses and parks. Polypropylene with a polyethylene film that's perfectly suited for splash/spray protection, plus is thick and durable at 2 oz./sq. yd. Blue color has excellent employee acceptance.

Item #	Size Range	Description	Price
134538	M-XL	Pants	\$5.49
134538	2XL	Pants	\$5.79
134538	3XL	Pants	\$5.99
134537	M-XL	Coveralls	\$7.49
134537	2XL	Coveralls	\$8.29
134537	3XL	Coveralls	\$8.49



Lakeland ChemMAX® 1 Coverall with Open Ankles and Wrists

The ChemMAX 1 Coverall blocks many harmful contaminants from penetrating to inner clothing. These coveralls are constructed of polyethylene barrier film and continuous-filament, non woven polypropylene and feature serged seams to protect you from dry particulates and light chemical splashes. Fabric weighs 2.29 oz./sq. yd. Zipper front. One size fits most. Yellow color.

Coveralls run short through the back. If in doubt, order one size larger.

Surcharge Note: Sizes 3XL-4XL have a \$2 surcharge, which will be added at checkout.

Item #	Size Range	Description	Seam Style	Price
182745	M-2XL	Hooded Coverall (elastic)	Bound	\$14.79
182745	M-2XL	Hooded Coverall (elastic)	Bound	\$14.79
182745	M-2XL	Hooded Coverall (elastic)	Bound	\$14.79
182745	M-2XL	Hooded Coverall (elastic)	Bound	\$14.79
182745	3XL-4XL	Hooded Coverall (elastic)	Bound	\$16.99
182745	3XL-4XL	Hooded Coverall (elastic)	Bound	\$16.99
211871		Apron (10pk)	Serged	\$24.99
211873	M	Unhooded Coverall (open)	Serged	\$5.62
211872		Apron w/ Sleeves (10pk)	Bound	\$52.99



Lakeland ChemMax® 2 Saranex™ Hooded Coveralls

Superior strength and proven protection make these Lakeland hooded coveralls an ideal choice for chemical mixing and handling

Quality, value, durability and the proven protection of Dow Saranex 23P barrier film. The superior strength of two layers of bi-component spunbond, nonwoven substrate provides quality protection for chemical mixing and handling, including orchard pesticide spraying. Hooded coveralls have elastic wrists and ankles. Specify Men's Size: M-3XL.

SURCHARGE NOTE: Sizes 3XL-4XL have a \$2 surcharge, which will be added at checkout.

WARNING: There are environments and uses for which these coveralls are unsuitable. It is the responsibility of the user to review available data to verify that the garment is appropriate for the intended use and meets all government and industry standards. Avoid open flame or intense heat.

NOTE: Due to the thousands of pesticide formulations available today, it's impossible to determine if a particular garment protects against a specific chemical. Therefore, we recommend testing the clothing against the chemical before using.

Item #	Price
214467	\$19.79



Tychem® SL Hooded Coveralls with Taped Seams

Superior durability and effective protection will make these DuPont hooded coveralls your new favorite protective wear

Hooded coverall with taped seams provide total liquidproof protection against Class I pesticides. Tychem 4000 is Saranex 23P film laminated to DuPont Tyvek fabric, resulting in high-tensile strength and abrasion resistance. Elastic ankles and wrists keep out contaminants. Specify Size: M-4XL.

SURCHARGE NOTE: Sizes 2XL-4XL have a \$20 surcharge per pkg., which will be added at checkout.

WARNING: There are environments and uses for which these coveralls are unsuitable. It is the responsibility of the user to review available data to verify that the garment is appropriate for the intended use and meets all government and industry standards. Avoid open flame or intense heat.

NOTE: Due to the thousands of pesticide formulations available today, it's impossible to determine if a particular garment protects against a specific chemical. Therefore, we recommend testing the clothing against the chemical before using.

Item #	Size Range	Qty./Pkg.	Price
214472	M-XL	6	\$239.99
214472	2XL-4XL	6	\$259.99



PERSONALIZE



Two-Piece Splash-Guard™ PVC Spray Suit

Use this Two-Piece Splash-Guard™; PVC Spray Suit for watering and chemical spray jobs. Spray suit is made of PVC-coated nylon—inside and out to resist chemicals and is 100% waterproof. PVC-Coated Jacket has a drawstring hood, snap-button front and snap-adjust cuffs. PVC-Coated bib overalls have adjustable suspenders and snap-closure cuffs and ankles. Meets pesticide label requirements for coveralls, long-sleeve shirts, pants and chemical-resistant suits. Meets requirements for chemical-resistant headwear. EPA Level A and B protection. Specify size: S-4XL.

Item #	Price
8397	\$22.49



PERSONALIZE



Heavy-Duty PVC Coveralls

These heavy-duty .30 mm PVC coveralls stand up to heavy industrial chemicals, toxic pesticides, solvents and caustics. The tough, nylon-weave base lasts years and resists abrasion. Double-coated PVC inside and out resists contamination. The attached hood has drawstring closure and meets requirements for chemical-resistant headwear. Double storm flap over full-length zipper, reinforced crotch, raglan sleeve construction for free movement, and telescoping inner sleeve with elastic wrist. Extra-generous sizing provides air flow to keep you cool. Liquid proof and flame retardant. Green color. 2.25 lb. Washable, drip dry. Specify size: M/L or XL/2XL.

Item #	Price
AC141G	\$96.99



TINGLEY Chemical-Resistant Jacket and Bib Overalls

Tingley Chemical-Resistant Jacket not only protects you from high-toxicity chemicals and pesticides, it's also flame-resistant!

This PVC/polyester-blend jacket protects you from many industrial acids, chemicals and caustic elements, plus it meets pesticide label requirements for coveralls, long-sleeve shirts, pants and chemical-resistant suits. FR material with hidden hardware improves protection. Suggested for use in sanitation, food processing and acid-based production. Green color. Specify Men's Size: S-4XL.

Item #	Description	Price
181963	Jacket	\$34.99



Ansell Hycar® Nitrile Apron

Heavy-duty protection that saves your clothes and skin from grease, animal fats and certain chemicals

The tough, durable Hycar nitrile blend of this heavy-duty apron make it great for everyday wear during food processing, chemical processing, industrial maintenance or meat packing applications.

Item #	Price
219187	\$17.99



Honeywell NORTH BY HONEYWELL SilverShield® Chemical-Resistant Coat-Style Apron

Resist permeation and breakthrough by over 280 chemicals

This SilverShield Protective Coat-Style Apron provides extra coverage on the shoulders and arms for added splash protection. Size Large.

Item #	Description	Price
10348	Traditional	\$19.99
51996L	Coat-Style	\$63.99



Chemical Resistant Apron and Sleeves

Protect your clothing from chemical spills, grease, oil and more with this comfortable apron

When the job doesn't call for a full coverall, you have the option of an apron. This classic, bib-style Chemical Resistant Apron fits comfortably over your work clothing for convenient, lightweight protection. Sold individually. Apron: Breathable microporous fabric designed in the classic bib style. Extra long sewn ties and a roomy neck loop. 36" x 28". Sleeves: elbow-length coated polypropylene sleeves with elastic ends for a secure fit. 18"L.

Item #	Description	Qty./Pkg.	Price
150729	Apron	1	\$2.79
150734	Sleeves	100 pr.	\$41.69



Ansell Lightweight, Neoprene Apron

Create a protective barrier that saves your clothes from damage when working with acids, oils, chemicals and more

This yellow Neoprene Apron is an excellent barrier to acids, oils, greases, chemicals and more. Lightweight apron is latex free. 45" x 35". Weights 1 lb. One size fits most.

Item #	Price
6181	\$18.49



PERSONALIZE
Ansell Midweight PVC Apron

Get protection from moderate-toxicity pesticides without restricting movement

Apron is a low-cost choice offering excellent chemical protection and tear resistance. Constructed of 18-mil vinyl that's heavy enough so the wind won't blow it around yet light enough for ease of movement. Extremely durable grommets are electronically heat sealed. Includes extra-long nylon string ties. 44"L x 33"W.

Item #	Price
PVC45G	\$7.99



WE Chapps™ Adjustable Chemical Wash Apron

Protect yourself from chemicals and pesticides

Protect your upper and lower body from chemical splashes with this 15-mil, heavy duty butyl apron. Reusable apron is made to protect you from chemicals and pesticides up to Class I, plus resists acids, oils, animal fats and solvents. Adjustable neck and waist ties combined with the adjustable 36" to 46"L ensure a custom fit. 30"W. One size fits most.

Item #	Price
211731	\$49.99



Ansell Disposable Polyethylene Aprons

Ansell Disposable Polyethylene Aprons helps protect your clothes while still maintaining a professional look

These lightweight Ansell Disposable Polyethylene Aprons are strong enough to withstand light- to medium-duty use, yet economical enough to toss. Aprons comply with FDA regulations for food contact. 1.25-mil thick, smooth polyethylene may be cleaned for reuse. Resistant to chemicals, fats and oils. Packed for easy removal of one apron at a time. 46"L x 28"W. White. One size fits most.

Item #	Qty./Pkg.	Price
105356	100	\$26.49



Ansell Waterproof, 8-mil Vinyl Sleeves

Arm yourself with these vinyl sleeves to protect clothing and forearms from moisture and chemicals

These Waterproof, 8-mil Vinyl Sleeves are ideal for use when your pesticide label calls for a long sleeve shirt, or when EPA Level C or D protection is required. Sold as one pair. White color.

Item #	Qty./Pkg.	Price
222282	1 pr.	\$2.99



CELLUCAP Nonslip Shoe Covers

These Shoe Covers feature a non-skid tread pattern on the bottom to help you maintain your footing

Durable polypropylene protects shoes from dirt and grime. Elasticized seam provides an adjustable fit. Dispenser box of 50 pair. Specify Men's shoe size: L (8-11) or XL (12-13).

Item #	Size Range	Qty. / Pkg.	Toe Type	Height	Price
48086	L	50	Plain	6"	\$18.99
48088	XL	50	Plain	6"	\$19.99



DUPONT Protective Boot Covers

Protect your feet when using pesticides or in livestock containment

18"H protection against light pesticide sprays and splashes. Also use in livestock confinement and VET/AI work. Vinyl sole. Water repellent. Pkg. of 50 pair. Specify Men's shoe size: L (up to size 13) or XL (up to size 19).

NOTE: Wear boot covers just once to prevent cross contamination.

Item #	Size Range	Qty. / Pkg.	Toe Type	Height	Price
211689	Up to 13-Up to 19	50	Plain	18"	\$87.99
211689	Up to 13-Up to 19	50	Plain	18"	\$87.99



AGRI-PRO Disposable Elastic-Top Walking Boot Covers

Cover work boots up to size 13

Durable, disposable boots accommodate large-soled work boots up to size 13. Elastic top stretches wide, yet provides a snug fit to keep debris out. Rough surface on the bottom gives you a good grip on slippery surfaces. One size fits most. 3-mil sold as 25-pr. pack, 6-mil sold as 5-pr. pack.

Item #	Toe Type	Height	Price
G32750	Plain	19-1/2"	\$16.99
G32751	Plain	19-1/2"	\$8.99



Over-the-Shoe Protective Polyethylene Plastic Boots

Easily protect your boots and shoes from muck and dirt with these durable Over-the-Shoe Plastic Boots

Be sure to keep your footwear clean and free of manure, mud and grime while working in barns, ranches and other messy facilities with these 17"H, elastic-topped, over-the-shoe protective plastic boots. Lightly embossed texture. Blue. 17"H. Package of 50 individual boots. Fits Men's shoe size up to 12.

NOTE: Wear boots just once before discarding to prevent cross-facility contamination. Not for use on snow or ice.

Item #	Thickness	Toe Type	Height	Price
224447	4 mil	Plain	17"	\$13.49
224448	6 mil	Plain	17"	\$17.24



Knot-a-Boot® 4-mil Polyethylene Plastic Boots

Polyethylene Plastic 4-mil Boots protect your boots and shoes from mud, manure and grime. Wear them with or without using the handy tie feature. Clear. Package of 50 individual boots.

NOTE: Wear boots just once before discarding to prevent cross-facility contamination. Not for use on snow or ice.

Item #	Length	Toe Type	Height	Price
224445	16"	Plain	21"	\$13.49
224446	18.75"	Plain	21"	\$17.24



Yellow Over-the-Shoe Booties

These yellow booties protect feet and shoes when spraying or cleaning up

Lightweight, 12"H latex booties are disposable and 100% waterproof. Textured outsole provides better slip resistance. Specify Men's shoe size: S (6-7), M (8-9), L (10-11), XL (12-13) or 2XL (14-15).

Item #	Price
211661	\$7.99



GEMPLERS Basic Pesticide Protection Kit

Gempler's Basic Pesticide Safety Starter Kit provides basic protection for mixing and applying most low-toxicity pesticides

Gempler's Basic Pesticide Safety Starter Kit contains the four basic safety items you should wear to provide respiratory, eye, hand and body protection. Kit includes: (1) Reusable, NIOSH-approved Moldex® dual-cartridge pesticide respirator with pre-filters - medium size only; (1) 45"L x 35"W medium-weight, chemical-resistant PVC apron - blue-green color; (2) pr. unlined, chemical-resistant nitrile gloves, which offer good dexterity - green color, large size only; (1) Fog-free chemical splash goggle with indirect ports; (1) Chemical-resistant, yellow, urethane storage bag; (1) EPA Handler's Handbook covering proper use of PPE and complete WPS training, 106 pages; (1) WPS Reference Guide, 108 pages.

Item #	Price
1024A	\$68.99



GEMPLERS Basic Pesticide Mixer/ Applicator Kit

Prepare yourself with head-to-toe protection against low-toxicity pesticides

Protect yourself and your workers against pesticide poisoning. This kit is designed to meet farmers' specific needs during a typical 14-day planting cycle. Kit Includes: (3) Pair green nitrile, chemical-resistant gloves. Size Large Only. (6) Pair white Tyvek, chemical-resistant disposable coveralls. Size XL only. (1) 45"Lx35"W blue-green PVC, chemical-resistant apron. (1) Indirectly vented chemical splash goggle. (1) Flip-up faceshield with acetate window. (1) Moldex dual-cartridge pesticide respirator with cartridges and pre-filters. Size Medium only. (1) Pair yellow, latex-rubber overshoes. Size XL only. EPA-accepted "Warning" sign. (1) WPS Reference Guide.

NOTE: Do not use in heavy spray mist applications such as orchard spraying.

Item #	Price
1209A	\$119.99



Spray Rig Decontamination Kit

Spray Rig Decontamination Kit mounts on spray rigs for convenient access and can withstand the punishment of field work

This Complete Spray Rig Decontamination Kit welds or bolts to your rig with a sturdy steel mounting cradle for quick, easy access. The Chemwash tank operates on gravity flow: Simply fill through the large diameter spout located on top. A convenient spigot at the bottom allows you to decontaminate your hands, while the attached 28"L tube is readily available for an emergency eye flush.

Item #	Price
G1301K	\$149.99



Insulated, Portable Decontamination Kit

Transport your decontamination supplies to any job site with this handy kit

Transport decontamination supplies to any jobsite with this handy kit. Heavy-duty carrying bag is constructed of thick, bright yellow nylon for easy identification and is heavily insulated to keep your water and eyewash solution at a desired temperature. Includes bilingual bag label and instruction card.

Item #	Price
109623	\$127.99



GEMPLERS Pesticide First Aid Kit

GEMPLER'S Exclusive Pesticide First Aid Kit includes items recommended by the Center for Disease Control for pesticide first aid response

Be prepared in case a pesticide first aid situation arises. This unique kit contains all the supplies recommended by the Center for Disease Control (CDC) for responding to a pesticide trauma. Housed in a bright red bag for easy identification, this kit should be stowed in a safe yet readily accessible place away from possible pesticide contamination. Bag measures 8"H x 15"W x 9"D.

Item #	Price
162321	\$122.99



Honeywell NORTH NORTH SAFETY Type I Class G & E Wide-Brim Hard Hat

This Type I Class G & E Wide-Brim Hard Hat protects you from the sun's harmful rays, rain and falling debris better than regular hard hats. Meets ANSI Z-89.1-2003 Type I Class G & E and CSA Class E standards.

Item #	Price
53344	\$11.59
10968	\$12.99
G10938	\$20.39
G10938	\$23.99
G10938	\$23.99
G10938	\$23.99
G10938	\$23.99



Honeywell NORTH Peak Type I Class G and E Hard Hats

This Economical Peak Hard Hat with Pinlock Suspension has a 4-point polyethylene suspension that provides superior protection and lightweight comfort for day-long wear. Made from dielectric materials, hat meets ANSI Z-89.1-2003 Type I Class G & E and CSA Class E standards. Tested in ISO 9002 laboratories.

Item #	Color	Price
10909	Blue	\$8.59



Honeywell NORTH Hard Hat Replacement Pin-lock Suspension

Replacement 4-point Pin-lock Suspension for Peak Hard Hat

Replacement 4-point, polyethylene pin-lock suspension for use with North peak hard hats (sold separately). Hard Hat Not Included.

Item #	Color	Price
10961	Black	\$3.29



Honeywell NORTH NORTH SAFETY Type II Hard Hat

This North Type II Hard Hat is energy absorbing to protect against top and lateral impact and penetration. Features a 4-point suspension and meets ANSI Z89.1-2003 Type II, Class E. CSA Z94.1-92, Class E.

Item #	Price
53386W	\$38.99
53386	\$38.99

- White
- Yellow



ELVEX ProGuard™ Woodsman's Helmet with Nylon Mesh Visor

Dielectric protection for use in areas where you may come into contact with electrical lines. Includes the Tectra award-winning safety helmet from Elvex, medium-profile earmuffs, nylon screen face shields and visor bracket. Black nylon mesh. Meets ANSI Z89.1-2009, Type 1, Class E, G, and C. 6-point ratchet suspension.

Item #	NRR	Suspension	Price
214359	24dB	Pinlock	\$40.99
145642	25dB	Ratchet	\$43.99
165560	27dB	Ratchet	\$51.99



ELVEX ProGuard™ Ventilated Helmet with Steel Mesh Visor

Elvex ProGuard Ventilated Woodsman's Helmet with Steel Mesh Visor gives you an integrated protection system for your head, face and hearing

A uniquely integrated protection system for your head, face and hearing. This Elvex ProGuard Ventilated Woodsman's Helmet is just what you need for outdoor jobs where no electrical hazards exist. Visor bracket included. Meets ANSI Z89.1-2009 Type I Class C requirements. The hearing protection is tested in accordance with ANSI S3.19-1974.

Item #	NRR	Suspension	Price
187153	25dB	Pinlock	\$40.99
187151	25dB	Ratchet	\$42.99
187152	27dB	Ratchet	\$46.99



ELVEX ProGuard™ Woodsman's Helmet with Lexan™ Shield

Elvex ProGuard Woodsman's Helmet with Lexan™ Shield plus 25 dB NRR

This Elvex ProGuard Woodsman's Helmet is ideal when using chain saws and other power tools that might throw debris in your face. Available in a dielectric model (to be worn where the user may come in contact with electric lines) or ventilated model (may be used in outdoor situations where no electrical hazards exist). Features a 6-point ratchet suspension safety cap and nylon webbing. Earmuffs have a 25dB NRR. NOTE: ANSI Z87 requires separate eye protection, suitable to the situation, in addition to a face shield.

Item #	Dielectric	Venting	Price
214356	No	Vented	\$45.99
214355	Yes	Non-Vented	\$45.99



ELVEX AirSpecs™ Steel Mesh Chain Saw Goggles

Protect your eyes when cutting wood

The Elvex AirSpecs Steel Mesh Chain Saw Goggles feature steel mesh "lenses" that protect your eyes from pokes and large debris, while allowing air to pass through. EVA closed-cell foam provides a comfortable face seal. Meet ANSI Z87.1 for basic impact (1" ball-drop) protection.

Item #	Price
225449	\$9.79



Saw Buck™ Chainsaw Chaps

Ultimate chainsaw safety that's 5X stronger than steel

Saw Buck™ Chainsaw Chaps provide the ultimate safety protection with a four-ply layer that is pound-for-pound, 5X stronger than steel. Four adjustable leg straps and a nylon web belt provide a secure fit. Lightweight and flexible, these chaps allow for easy movement in any position. 2 lb.

NOTE: Not tested for use with electric chain saws.

Item #	Length	Color	Price
173458	32"	Orange	\$130.69
18042	32"	Green	\$130.69
18043	36"	Green	\$152.69
173459	36"	Orange	\$152.69
18044	40"	Green	\$164.99
173460	40"	Orange	\$164.99



Economy Chainsaw Apron Chaps

Made from tough, durable six-ply Engtex nylon. Interlocking leg buckles. Water- and oil-resistant fabric. Adjustable belt fits waist sizes 30-42. Length is measured from belt loop to bottom of chaps.

Item #	Price
174445	\$89.69



RAC Apron-Style Chain Saw Chaps

Innovative RAC design reduces downtime with fast, easy strap and buckle repairs. Apron style offers full-front, 180° leg protection. Adjustable to various leg sizes and comfortable for all-day wear. Stretchable and adjustable trim-to-fit belt fits up to a 48" waist. Meet ASTM F1897-2008. UL approved. Specify length and inseam.

Item #	Description	Price
225362	Apron Style Chaps	\$94.99



Summer Weight Chain Saw Pants

Ideal for cutting wood in warm environments. Six layers of Engtex™ protective fabric shield the wearer by jamming the moving parts of a chain saw chain on contact. The front outer shell is constructed of tough Ambush® material for rugged use and the back is made with breathable Visa® polyester for outstanding flexibility and comfort. All have 33" inseam. Meet OSHA 1910-266. Specify Size: S-2XL.

Item #	Price
92547	\$115.99



ELVEX ProChapsZ™ Chain Saw Chaps

These Elvex ProChapsZ Chain Saw Chaps add an extra layer of safety by reducing the number of catch points where branches or other items can pull or snag

Elvex ProChapsZ Chain Saw Chaps are made with durable, 1,000-denier fabric with a Cordura® nylon outer and features Prolar™ padding that effectively jams chain to quickly stop cutting action. Full wraparound calf with patented asymmetrical design give you even more protection. UL certified. Meet ASTM F-1897-2008 standard.

Item #	Length	Price
225450	36"	\$117.39
225451	39"	\$121.99



Strap Chapps Trimmer Chaps

Protect your legs - from the knees down to the top of your feet - from flying debris your equipment kicks up

Protect your legs from the knees down to the top of your feet. Fronts and sides of the legs are protected, leaving the back slightly open for ventilation. Elastic straps with hook-and-loop fasteners secure chaps. Keep socks and shoelaces clean and prevent debris from getting in your shoes. Patented height adjustment system. Sold as a pair. One size fits most.

Item #	Price
G10584	\$41.99



Hedge Trimmer Chapps™

Protect your legs during your next trimming project

Hedge Trimmer Chapps help prevent injuries to your thighs, knees and groin when using hedge trimmers - even when you're running at full throttle. Abrasion, tear and snag resistant chaps give extra protection against hedge trimmers, even when running at full throttle. Impenetrable, yet flexible thigh shields help prevent injuries. Feature waterproof shell and cool cotton inner liner. Open back and shorter length to keep you cool. Elastic strap and hook and look fasteners.

Item #	Price
193113	\$99.99



ELVEX Chainsaw Safety Chaps - 90 Series

These 90 Series Elvex Chainsaw Chaps give you reliable protection that exceeds industry requirements. Made of a tough, 420-denier nylon facing, they resist cut throughs from chains moving up to 3,000' per min. 2,500' per minute is required by the American Pulpwood Association (APA). Specify outseam length: 33", 36" or 39". Length is measured from belt loop to bottom of chap. Orange color. NOTE: Not tested for use with electric chainsaws.

Item #	Description	Price
JE94	94 Series Chaps	\$106.99
159916	91 Series Chaps	\$117.39
10213	90 Series Chaps	\$79.99



ELVEX ProVest II™ Chainsaw Vest

Elvex ProVest II chainsaw safety vest has open sides and a mesh back to help keep you cool

When the temperature starts to climb, add a layer of protection without adding hot, bulky layers. The Elvex ProVest II Chainsaw Vest is made with a water-resistant and breathable 65% poly, 35% cotton blend outer fabric. The vest will protect your upper chest and shoulder area from dangerous kickbacks during light-duty applications. Specify Men's Chest Size: M (38-42), L (42-46), XL (46-50).

Item #	Price
222382	\$97.79



ELVEX Chain Saw Pro-Gloves

Get heavy-duty chain saw protection for your left hand and better freedom of movement and dexterity for your right

These Elvex Chain Saw Pro-Gloves feature an open suede cuff with Velcro® closure for a customized fit. Standard five-finger design. Back of left hand has added protection, padded with multi-layer, high tenacity polyester clogging material for protection from chain saw accidents. Palms on both hands are made from cowhide leather for better gripping. Specify Men's Size: M-XL.

Item #	Price
214353	\$42.99



Hi-Vis Chainsaw Shirt

A high-visibility, chainsaw shirt delivers cut protection and extra visibility

This SwedePro Hi-Vis Long-Sleeved Shirt protects you while cutting. Engtex protective material prevents flying debris from penetrating the shirt. Top of shirt is breathable polyester material for flexibility; body of shirt is a polyester mesh for comfort and breath-ability. Specify Men's Chest Size: S-3XL.

Item #	Price
165784	\$83.79



Full-Grain Leather Chain Saw Boots

Complete protection for your feet

Protect your feet with these SwedePro® Full-grain Leather steel toe Chain Saw Boots. 3" steel shank provides extra support. Long-lasting Goodyear welt construction. Heavy duty Vibram soles handle rough terrain. The extra-wide steel toe meets ANSI standard Z41PT83. Boots meet the OSHA reg. 1910.266 requirement for chain saw protective footwear. Sizes 6-14

Item #	Price
165785	\$240.99



Timberwolf Chainsaw Boots With Safety Toe

Made from NBR rubber and a heavy-duty cotton canvas lining with air-cushioned heel pockets. Ballistic nylon cut protection and a lace-up debris collar. Achilles tendon and metatarsal protection. Self-cleaning lug sole is oil, chemical and slip resistant. Steel toe and plate meet Class 1 standards. Meet CSA Omega Electric Shock Resistance standard. Meet ASTM F1818 for chain saw protection and CE Class 2 for chain saw resistance. Specify Men's whole sizes 6-14.

Item #	Size Range	Sole Type	Toe Type	Height	Price
219751	6-14	Lug	Steel	16"	\$104.99
219752	9	Calked Lug	Steel	16"	\$75.99



RADIANS **Head-Cooling Products**

Stay cool on hot days

Arctic Skull Head-Cooling Towels are made of Arctic™ technology that quickly cools you down on hot days. Simply soak the towel, headband or head shade in water for 2 to 3 minutes before wearing. Antimicrobial treated to help prevent mold buildup and odor. Reusable. One size fits most. Specify Color.

Item #	Safety Supplies: Color	Price
224452	Blue	\$5.79
224451	Blue	\$9.99



MiraCool® Ranger Cooling Hats and Bandanas

MiraCool Ranger Cooling Hat provides all-day cool comfort on hot days

This MiraCool Ranger Cooling Hat contains highly absorbent crystals that absorb 1,000X their weight in cool, refreshing water. Simply soak hat in cool water for 10 min. to activate the gel crystals. Once soaked, the crystals use the power of evaporation to provide extended cooling. Crystals are encased in cotton for all-day comfort. Grommets allow for better ventilation, which increases the evaporation rate, which provides better cooling. When worn dry, the soft terry cloth lining soaks up perspiration while you work. Full brim provides excellent UV protection. Reusable and hand washable.

Item #	Safety Supplies: Size	Price
40155	Medium	\$14.99
40155	Large	\$14.99
30763		\$4.29



Evaporative Cooling Ranger Hat

This evaporative cooling hat is an easy, cost-effective way to protect against the dangers of heat stress. Simply soak in water for 1–2 min. The unique polymer embedded fabric absorbs water and provides cooling relief through evaporation. The hat remains effective for 5–10 hr. Comfortable cotton outer with polymer embedded fabric inner. Khaki. Specify Size: S/M, L/XL or 2XL/3XL.

Item #	Safety Supplies: Size	Price
165510	2XL/3XL	\$14.99



Evaporative Cooling Baseball Cap

Baseball cap uses evaporation to keep you cool

This Evaporative Cooling Baseball Cap is an easy, cost-effective way to protect against the dangers of heat stress. Simply soak in water for 1-2 min. The unique polymer embedded fabric absorbs the water and provides cooling relief through evaporation. The hat remains active for 5–10 hr. and can be reactivated simply by re-soaking in water. Adjustable hook-and-loop closure provides a personalized fit. One size fits most.

Item #	Price
165557	\$11.99

Professional-Grade Water Coolers

Keep you cool and hydrated in the field. A 12-gal. two-pail cooler is available in 12-gal. capacity. The 12-gal. cooler is available in 12-gal. capacity. The 12-gal. cooler is available in 12-gal. capacity.

Item #	Cap.	Price	Item #	Cap.	Price
181000	12 gal.	\$199.99	181012	12 gal.	\$269.99
181001	12 gal.	\$149.99	181013	12 gal.	\$199.99
181002	12 gal.	\$179.99			
181003	12 gal.	\$189.99			

What's New! Igloo Water directly on cooler!

181004 181005 181012 181013

181010 181011

181012

181013

181014

181015

181016

181017

181018

181019

181020

181021

181022

181023

181024

181025

181026

181027

181028

181029

181030

181031

181032

181033

181034

181035

181036

181037

181038

181039

181040

181041

181042

181043

181044

181045

181046

181047

181048

181049

181050

181051

181052

181053

181054

181055

181056

181057

181058

181059

181060

181061

181062

181063

181064

181065

181066

181067

181068

181069

181070

181071

181072

181073

181074

181075

181076

181077

181078

181079

181080

181081

181082

181083

181084

181085

181086

181087

181088

181089

181090

181091

181092

181093

181094

181095

181096

181097

181098

181099

181100

181101

181102

181103

181104

181105

181106

181107

181108

181109

181110

181111

181112

181113

181114

181115

181116

181117

181118

181119

181120

181121

181122

181123

181124

181125

181126

181127

181128

181129

181130

181131

181132

181133

181134

181135

181136

181137

181138

181139

181140

181141

181142

181143

181144

181145

181146

181147

181148

181149

181150

181151

181152

181153

181154

181155

181156

181157

181158

181159

181160

181161

181162

181163

181164

181165

181166

181167

181168

181169

181170

181171

181172

181173

181174

181175

181176

181177

181178

181179

181180

181181

181182

181183

181184

181185

181186

181187

181188

181189

181190

181191

181192

181193

181194

181195

181196

181197

181198

181199

181200

181201

181202

181203

181204

181205

181206

181207

181208

181209

181210

181211

181212

181213

181214

181215

181216

181217

181218

181219

181220

181221

181222

181223

181224

181225

181226

181227

181228

181229

181230

181231

181232

181233

181234

181235

181236

181237

181238

181239

181240

181241

181242

181243

181244

181245

181246

181247

181248

181249

181250

181251

181252

181253

181254

181255

181256

181257

181258

181259

181260

181261

181262

181263

181264

181265

181266

181267

181268

181269

181270

181271

181272

181273

181274

181275

181276

181277

181278

181279

181280

181281

181282

181283

181284

181285

181286

181287

181288

181289

181290

181291

181292

181293

181294

181295

181296

181297

181298

181299

181300

181301

181302

181303

181304

181305

181306

181307

181308

181309

181310

181311

181312

181313

181314

181315

181316

181317

181318

181319

181320

181321

181322

181323

181324

181325

181326

181327

181328

181329

181330

181331

181332

181333

181334

181335

181336

181337

181338

181339

181340

181341

181342

181343

181344

181345

181346

181347

181348

181349

181350

181351

181352

181353

181354

181355

181356

181357

181358

181359

181360

181361

181362

181363

181364

181365

181366

181367

181368

181369

181370

181371

181372

181373

181374

181375

181376

181377

181378

181379

181380

181381

181382

181383

181384

181385

181386

181387

181388

181389

181390

181391

181392

181393

181394

181395

181396

181397

181398

181399

181400

181401

181402

181403

181404

181405

181406

181407

181408

181409

181410

181411

181412

181413

181414

181415

181416

181417

181418

181419

181420

181421

181422

181423

181424

181425

181426

181427

181428

181429

181430

181431

181432

181433

181434

181435

181436

181437

181438

181439

181440

181441

181442

181443

181444

181445

181446

181447

181448

181449

181450

181451

181452

181453

181454

181455

181456

181457

181458

181459

181460

181461

181462

181463

181464

181465

181466

181467

181468

181469

181470

181471

181472

181473

181474

181475

181476

181477

181478

181479

181480

181481

181482

181483

181484

181485

181486

181487

181488

181489

181490

181491

181492

181493

181494

181495

181496

181497

181498

181499

181500



Super Tough™ STX Cooler

Igloo Super Tough STX Cooler is one of the most durable coolers on the market

The body is 40% heavier to take a beating and still be ready for your next load. Rugged side handles are bolted through the body and are reinforced with gasketed back-up plates so they won't pull out. Dual latches are stainless steel in the hinge and front plate and feature poly snaps for longer life and secure closure. Hose compatible drain plug allows quick draining and easy cleaning. Available in 120- or 150-qt. capacity.

Item #	Price
222362	\$174.99
222363	\$227.99



6-gal. Water Utility Can

Transport clean water to field sites easily with this Igloo Utility Can

Ideal for transporting tap water to field sites for easy decontamination. 13-3/4"L x 7"W x 21-1/4"H.

Item #	Price
219043	\$29.99



G Drink Mix Powder Packs

Prevent dehydration and heat stress while replenishing essential carbohydrates and electrolytes lost through sweat with these Gatorade powder packets

These Gatorade instant powder packets are ideal for mixing in the field. Just pour into cooler, add water and mix. Convenient poly pouches store easily.

NOTE: Riptide Rush™ is grape flavored.

Item #	Flavor	Yield Per Package	Price
125773	Glacier Freeze	6 gal.	\$14.99
125772	Fruit Punch	1 gal.	\$3.79
10117	Glacier Freeze	2-1/2 gal.	\$7.49

Medique® Medi-Lyte® Electrolyte Tablets

Medi-Lyte Electrolyte Tablets provide quick, temporary relief of symptoms related to heat stress

These Medi-Lyte Electrolyte Tablets provide you with quick and temporary relief from the fatigue and muscle cramping associated with heat stress. These tablets work to replenish minerals lost from heat and excessive perspiration. Each tablet contains 40mg potassium chloride, 10.64mg calcium phosphate and 12mg magnesium carbonate. Specify Quantity.

Item #	Safety Supplies: Size	Price
40542	250 packs of 2 tablets	\$26.99
40543	50 packs of 2 tablets	\$9.99



Igloo 1-gal. Beverage Cooler

Igloo 1-gal. Beverage Cooler is fully insulated to keep drinks cool longer

Igloo's personal beverage cooler keeps water readily at hand when you're on the go. Flip-spout is great for sipping or pouring, and side spout grips help keep it clean. Wide-mouth opening makes filling and cleaning easy. Swing-up carrying handle. One gallon capacity.

Item #	Price
214587	\$14.79



G Personal Water Cooler, 1 gal.

This cooler is no stranger to hard work - it keeps your beverages cold and resists impact like a champ

Fill this Gatorade 1-gal. Personal Water Cooler with your favorite beverage, add ice and you've got all-day refreshment.

Item #	Price
83933	\$20.99



GEMPLER'S Vehicle First Aid Kit

All the first aid supplies you need in a portable case

GEMPLER'S vehicle first aid kit contains all the first aid supplies that hard-working people need.

Kit contains:

- (16) - 3" x 1" Bandages
- (4) - 3" x 3" Gauze Pad
- (3) - Alcohol Wipes
- (3) - Ammonia Inhalants
- (3) - Sting/Bite Wipes
- (2) - 4" x 4" Gauze Pads
- (2) - 4-1/2" x 2" Bandages
- (2) - Oval Eye Pads
- (1) - 1/2-oz. Antiseptic Ointment
- (1) - 1/2" x 7-1/2'L Tape Roll
- (1) - 2" Gauze Roll
- (1) - 5" x 9" Combine Pad
- (1) - Knuckle Bandage
- (1) - Scissors
- (1) - Tweezers

Need more options?

Note: not for sale in (AL;GA).

Item #	HM	Price
139242	▲	\$18.99

▲Requires special handling due to DOT regulations. Additional shipping charges will apply. Cannot be shipped by air.



Medique[®] ANSI-Compliant Three-Shelf Metal First Aid Kit

Have the medical supplies you need within reach

Have the medical supplies you need within reach with this pre-filled Three-Shelf Metal First Aid Kit that meets the updated ANSI standard. Metal case can be wall-mounted. Meets ANSI Z308.1-2015.

Kit includes one package each of the refills listed in the chart below, plus:

- (1) 3-oz. burn spray
- (1) 2-oz. burn spray
- (1) Unit dose Water-Jel[®] burn treatment
- (2) 4"W x 4"L Burnaid[®] dressing
- (1) Disposable tweezers
- (1) Multipurpose splint
- (40) Extra-heavy knuckle bandages
- (40) Extra-heavy fingertip bandages
- (50) 7/8"W x 3"L flex fabric bandages
- (100) 1"W x 3"L plastic strip bandages
- (4) 5"W x 9"L pads
- (2) 2"W stretch roller gauze
- (1) 4"W stretch roller gauze
- (1) 2-oz. antiseptic spray
- Bulk eyepads
- (2) Ice packs
- (1) CPR mask
- Bulk hand sanitizers
- (1) Latex tourniquet

KIT INCLUDES THESE REFILLS:

Item #	Price
228125	\$159.99



FIRST AID ONLY: General Workplace First Aid Cabinet

Eliminate fumbling around disorganized kits for the first aid supplies you need - this first aid cabinet keeps supplies organized and easy to access

This general workplace first aid cabinet features clearly labeled compartments that are easy to access and restock. A built-in expansion pocket allows customization to meet your specific needs. A swing-out door gives you easy access to supplies, and the handle makes for easy carrying.

Kit includes:

- (10) 1-1/2" x 1-1/2" Patch Plastic Bandages
- (25) 1" x 3" Fabric Bandages
- (25) 3/4" x 3" Plastic Bandages
- (10) Fingertip Fabric Bandages
- (10) Knuckle Fabric Bandages
- (1) 2" x 5 yd. Elastic Bandage Wrap
- (10) Butterfly Wound Closure
- (1) 40" x 40" x 56" Triangular Sling/Bandage
- (10) 2" x 2" Gauze Dressing Pads
- (10) 3" x 3" Gauze Dressing Pads
- (1) 2" Conforming Gauze Roll
- (1) 3" Conforming Gauze Roll
- (1) 5" x 9" Trauma Pad
- (20) Alcohol Cleansing Pads
- (10) BZK Antiseptic Towelettes
- (10) Castile Soap Towelettes
- (10) First Aid/Burn Cream
- (10) Antibiotic Ointment
- (1) 1/2" x 10 yd. First Aid Tape
- (1) Scissors
- (10) 2" Moleskin (blister prevention)
- (1) First Aid Guide
- (4) Exam-Quality Vinyl Gloves
- (1) Stainless Steel Tweezers
- (1) CPR Face Shield and Vinyl Gloves Set

Note: not for sale in (AL;GA).

Item #	HM	Price
212155	▲	\$127.99

▲ Requires special handling due to DOT regulations. Additional shipping charges will apply. Cannot be shipped by air.



Medications

Compare with Bayer®

Aspirin: Pain reliever and fever reducer. Relieves headaches, minor aches and pains, and more. Compare with Bayer®. Pkg. of 50 two-tablet packs.

Ibuprofen: Anti-inflammatory, fever reducer and pain reliever.

Non-Asprin: Acetaminophen pain reliever and fever reducer.

Allergy Plus: Relieves symptoms of hay fever or other upper respiratory allergies, aches, pains and more.

Cold & Cough: Complete cold-symptom relief for nasal congestion, sore throat, cough and pain. Non-drowsy.

Item #	Type	Size	Price
225792	Allergy Plus	50 packs of 2 tablets	\$14.99
225793	Cough and Cold	50 packs of 2 tablets	\$17.49
225788	Aspirin	50 packs of 2 tablets	\$4.89



QR Blood Stop Powder for Easy-to-Reach Wounds

QR Blood Stop Powder for easy-to-reach wounds stops bleeding and oozing on contact

Easy-to-use powder works quickly to stop bleeding and oozing. Apply powder directly to the wound and apply direct pressure on the affected area for approximately 15–30 seconds. Box includes two applications.

Item #	Type	Price
144810	Blood Stopper	\$10.49
144811	Blood Stopper	\$10.99



Sting-X™ Pain Relief Pads

Sting-X Pain Relief Pads bring fast sting relief against itching and pain from bug bites

Take these handy pads into the field with you to stop the pain and itching from insect bites and stings. Sting-X contains benzocaine for pain relief. 2"W x 2"W pads are the perfect size for your first aid kit or for carrying in your pockets. Pkg. of 25.

Item #	Price
109205	\$9.99



Insect Bite Relief

StingEze Insect Bite Relief relieves the pain and itching from common bug bites and stings

StingEze relieves pain and itching from insect bites and stings and acts as a first aid antiseptic reducing the risk of skin infection from minor cuts, scrapes and burns. Use Stingeze on bites from mosquitoes, bees, ticks, hornets, ants, fire ants, deerflies and horseflies. Contains benzocaine for pain relief. 0.5-oz. tube.

Item #	Price
175092	\$5.99



SPF 30 Facestick Sunscreen

Sunblock with convenient clean-hands application

Beyond Coastal facestick sunscreen is non-greasy and fast-absorbing. This easy-to-use sunblock uses avobenzene to block UVA and 97% of UVB rays. Also nourishes, moisturizes and repairs skin with aloe vera, shea butter and vitamin E. Water resistant for up to 40 min. Oxybenzone, parabon, petroleum, gluten and cruelty free. Fragrance free. SPF 30. 0.5-oz. stick.

Item #	Price
225686	\$7.29



Stay-Put® SPF 50 Sunscreen

A sweatproof sunscreen that doesn't rub off

Stay-Put System 2 sunscreen lotion is specially engineered to give you two layers of protection against the sun's harmful UV rays. The first layer penetrates deeper into the skin, while the second layer bonds closer to the skin's surface. You're still protected, even if the top layer is wiped off. Remains effective when you perspire. Enriched with aloe vera and assorted vitamins. SPF 50. Available only in 1 oz size.

Item #	Price
225929	\$4.29



SPF 31 Natural Lip & Face Sunscreen

Non-irritating protection for high-exposure areas

Apply Beyond Coastal® SPF 31 sunscreen directly to your cheeks, nose and ears for an all-natural broad-spectrum protection against UVA and UVB rays. Water resistant for up to 40 min. Clean, healthy sunblock helps restore skin and is antioxidant rich. Contains zinc oxide and titanium dioxide for added protection. Free of gluten, parabens, petroleum, cruelty and fragrance. 1-oz. tin.

Item #	Price
225687	\$7.29



SPF 30+ Industrial Sunscreen

Convenient sizes for small to large crews

This Industrial SPF 30+ sunscreen is an economical way to protect you and your work crews from the sun's harmful rays. Non-greasy, oil-free formula with zinc oxide creates a non-chemical barrier that absorbs UVA rays instead of scattering them. Protects against UVA and UVB rays. Reapply every 2 hours.

NOTE: Pump for 1-gal. jug sold separately (Item # 80673).

Item #	Safety Supplies: Size	Price
84053	8 oz.	\$16.99
84055	1 gal.	\$167.99
84054	32 oz.	\$59.99



SunX30 Sunscreen

This dual-action lotion blends a SPF30 sunscreen with a natural insect repellent for double protection

This unique, aloe- and vitamin E-based SunX Sunscreen absorbs quickly and contains the pleasant scent of cedar to naturally discourage insect bites without using DEET. Protects against UVA and UVB rays. Water- and sweat-resistant for long-lasting protection. Offered in either a 4-oz. bottle or 0.25-oz. (7g) packet sold in quantities of 25 packets.

Item #	Safety Supplies: Size	Price
10156	0.25 oz.	\$23.99
229893		\$34.99
229894		\$59.99
10157	4 oz.	\$9.49

BEFORE

IVY™ PRE-CONTACT SOLUTION

Helps stop the absorption of poison oak, ivy and sumac oils

Apply prior to exposure to poison oak, ivy or sumac to create an invisible barrier of protection. Does not allow plant oils to be absorbed by skin, yet allows skin to breathe. Not greasy, sticky or clay-like—goes on in a cream, gel and dries quickly on skin. Wash off with soap and water, and for better results, wash with a poison oak, ivy and sumac cleansing treatment.

Item #	Description	Price
10616	4-oz. bottle	\$9.99
10976	Box of 25 Towelettes	\$23.99



tec238 OUTDOOR SKIN CLEANSER

Treats poison oak, ivy and sumac rashes. Used extensively by utility linemen and forestry workers, this liquid cleanser removes the residual, itch-causing oils of poison oak, ivy and sumac from the skin if applied within 4 to 8 hrs. of exposure. Relieves itching and speeds healing more effectively than any product we have found.

Item #	Description	Price
TECNU	1-gal. bottle	\$10.99
TECNU32	32-oz. bottle	\$21.99
TEC25	Box of 50 Packets	\$37.99



Soap and water do NOT remove poisonous oils, which may continue to irritate skin for up to 2 to 3 days after exposure!

DURING

tec238 EXTREME™ SCRUB

Proven effective for battling an active rash

Highly effective scrub removes poison ivy, oak and sumac oils to help prevent a rash before it starts or keep it from spreading once one has formed. Active ingredient stops pain and relieves itching immediately. Use within 8 hrs. after exposure.

Item #	Description	Price
125798	4-oz. bottle	\$13.99



AFTER

IVY™ POST-CONTACT CLEANSER

Use after exposure

Clean your skin to get rid of rash-causing poison oak, ivy and sumac oils. Cleanses and moisturizes, reducing irritation.

Item #	Description	Price
219214	4-oz. bottle	\$8.99
219215	8-oz. bottle	\$9.99
10977	Box of 25 Towelettes	\$16.99



tec238 CALAGEL® ANTI-ITCH GEL

A great alternative to messy pink lotions

Combines the same skin protectant of a calamine-type lotion, with an antihistamine and aloe kept in a clear, non-stained gel, tries itching and sleeping.

Item #	Description	Price
33062	4-oz. bottle	\$6.99
125794	Box of 144 Packets	\$26.99



tec238 RASH RELIEF™ SPRAY

Sprays on a rash so you don't need to touch it

Unique, medicated spray provides relief and dries the aching, promotes healing and helps prevent sootting. For best results, first cleanse the area.

Item #	Size	Price
156275	6 oz.	\$13.99





JUSTRITE® Pesticide Storage Cabinet, 30 gal.

Store pesticides and other chemicals safely and securely

Keep chemicals safe and secure with this 30-gal. Justrite Pesticide Storage Cabinet. It has a manual closing door with a handle that can be padlocked to restrict pesticide and other chemical handling to authorized and trained users. It's just right for farms, nurseries, orchards, greenhouses and park and recreation facilities. Meets OSHA and NFPA code 30 requirements. FM approved.

NOTE: Chemical containers shown on shelving not included. Padlock not included. Some states require self-closing doors. Please check your state regulations.

Item #	Height	Width	Capacity	Depth	FT	FO	Price
151281	65"	43"	45 gal.	18"	*		\$1,118.00
151282	65"	34"	60 gal.	34"	*		\$1,713.00
151278	35"	23-1/4"	12 gal.	18"		■	\$732.49
151280	44"	43"	30 gal.	18"	*		\$991.59

*Item ships by Truck due to size and weight.

■Oversize item: additional shipping charges will apply.



JUSTRITE® Flammable-Liquid Storage Cabinets

Safely store flammable and combustible materials to reduce fire risks and protect your workers

This Justrite storage system for your flammable or combustible liquids provide hands-on access with minimal exposure. Self-latching doors encourage complete closure of doors by employees, maintaining the fire protection integrity of the cabinet. This cabinet features 18-ga. double-wall steel construction with 1-1/2" of insulating air space and chemical-resistant, lead-free powder-coat paint finish inside and out. Padlockable paddle handles have slip-resistant, Sure-grip EX™ grips offer easy, fingertip operation and reduces dangerous "catches" from passing traffic. Handles are supplied with two keys and accept padlocks (not included). Haz-Alert™ reflective labeling burst with high visibility when hit with a flashlight beam, making cabinets easy to find during power outages or fire conditions.

WARNING: This product can expose you to chemicals including lead, which are known to the State of California to cause cancer and birth defects or other reproductive harm. For more information go to www.P65Warnings.ca.gov.

Item #	Height	Width	Capacity	Depth	FT	FO	Price
143072	65"	43"	45 gal.	18"	*		\$1,079.00
143078	65"	43"	45 gal.	18"	*		\$1,159.00
143080	65"	34"	60 gal.	34"	*		\$1,229.00
143073	65"	34"	60 gal.	34"	*		\$1,264.00
143093	35"	23-1/4"	12 gal.	18"		■	\$686.99
143094	35"	23-1/4"	12 gal.	18"	*		\$724.99
143076	44"	43"	30 gal.	18"	*		\$824.99
143071	44"	43"	30 gal.	18"	*		\$869.99
151283	44"	43"	20 gal.	12"	*		\$871.99

*Item ships by Truck due to size and weight.

■Oversize item: additional shipping charges will apply.



SELLERS DuraSoak™ Light-Duty Sorbent Pads

Pack of 100 pads absorbs up to 20.1 gal.

Made from 65% recycled shop towel fibers with a layer of meltblown polypropylene added. Absorb oil, water, diesel fuel, grease, transmission fluid, hydraulic fluid, coolants and many other fluids. Class A fire retardant when pad is dry (lab tested per ASTM E84). Pkg. of 100 pads; each measures 19"L x 15"W.

Item #	Absorben t Capacity	Length	Width	Description	Qty. / Pkg.	Price
225612	20.1 gal.	19"	15"	Lightweight Pads	100	\$39.99
225607	30.3 gal.	19"	15"	Midweight Pads	100	\$51.29



Universal Chemical Sorbent Pads

These Universal Chemical Sorbent Pads make cleaning up a chemical spill fast and easy

Ideal for cleaning up just about any type of chemical spill including oils. Up to 20.5 gal. absorbed per box. Specify quantity.

Item #	Absorben t Capacity	Length	Width	Description	Qty. / Pkg.	Price
97211	20.5 gal.	19"	15"	Pad	100	\$81.49
108719	20 gal.	150'	12"	Roll	1	\$82.99



Spillyter Premium General-Purpose Pads

Pick up all liquids including acids, oil, coolants, solvents and water.

Absorb large or small nonaggressive spills like oil, coolants, solvents and water. Premium fine fibers absorb liquids while small-micron-diameter fibers provide greater retention and strength. Interlocking bonded sorbents prevent separation of fabric during cleanup.

Item #	Description	Qty./Pkg.	Price
97111	Lightweight Pads	200	\$81.99
97113	Heavyweight Pads	100	\$82.49
97112	Midweight Pads	100	\$82.99



Spillyter Sorbent Pads for Oil Only

These extra-strong absorbent pads stay together even when fully soaked with oil

Specifically for oil spills. Pads are excellent for leaks and spills on wet floors and will float on water - even when saturated with oil! Pkg. of 100 pads.

Item #	Description	Qty./Pkg.	Price
97124	White Pads	100	\$49.99



Large Scale Clean Up Kits

20-gal. Spill Kits provide the convenience of a built-in disposal container in a manageable, lightweight size
 20-gal. Spill Kits are conveniently packaged in a 100% polyethylene salvage drums that are UN-rated and highly visible for easy storage and quick spill response. Use universal spill kits for oil and water based chemical spills. Use oil based for oil and petroleum based spills. Hazmat spill kit absorb aggressive hazardous material spills. Each kit absorbs 11 gal.

Item #	Kit Type	Price
153864	Oil-Only	\$148.99
153863	Universal	\$149.99
153865	Haz-Mat	\$162.49



Economy Spill Kits

Affordable enough to place in every workstation or vehicle

Everything you need for chemical spills. Absorbs up to 5-gal. and works well on aggressive liquid and hazardous material spills. Can also be hung from a hook for quick access in emergency situations.

Item #	Spill Type	Price
84264	Universal/Maintenance	\$51.99
108543	Oil Only/Petroleum	\$51.99
108542	Chemical/Hazmat	\$56.99



OIL-DRI™ Hazardous Liquid Spill Kit

This emergency spill kit quickly absorbs up to 5-gal. of pesticides, oils, coolants or other liquids

This convenient Hazardous Liquid Spill Kit is ideal for a quick response to emergency leaks and spills. The plastic pail has a snap-on lid that keeps contents clean and dry, and also doubles as a disposal container once spills are cleaned up.

Liquid Spill Kit contains:

- (2) Absorbent socks
- (10) Universal perforated pads
- (1) Disposal bag and tie

Item #	Price
145760	\$45.99



Commando Pesticide Spill Kit

Quickly handle pesticide spills

The Chemsorb Commando Pesticide Spill Response Kit helps you quickly handle pesticide spills. It stores in a hangable, hi-vis bag for easy identification and immediate response when a spill happens. 5-gal. pick-up rating. 6.7 lb. Meets OSHA 29 CFR 1910.119. Kit Includes: (2) 3" x 48" Diking Tubes, (4) 16" x 9" x 2" Pillows, (2) Material Disposal Bags, (1) Instruction Sheet, (1) Pair of 15-mil Nitrile Gloves, (1) Pair of Goggles, (1) Pair of Saranex™-coated Boot Covers.

Item #	Price
270222	\$75.99



SPC Attack Pack™ Spill Kits

Convenient cleanup for liquid, oil or chemical spills

The SPC Attack Pack Spill Kits are ideal for keeping on hand anywhere liquids, oils or chemicals may be spilled. These space-saving, single-use kits are packed in a puncture- and UV-resistant bag and can easily be stored anywhere liquids are present. Each kit measures 18"W x 18"H.

Item #	Spill Type	Price
39814	Oil Only/Petroleum	\$64.49
40773	Universal/Maintenance	\$88.99
42967	Chemical	\$96.99



OIL-DRI QuickSorb® Super-Concentrated Floor Absorbent

This floor absorbent instantly absorbs oil, coolants and other liquid spills for quick and easy cleanup

Absorb oil, grease and water with this low-dust formula. Thermal processing increases sorbent hardness and durability so it won't break down into a slippery mess. Smaller granules cover more surface area and absorb twice as much liquid per pound so you only need half the amount. 20-lb pail.

Item #	Price
84346	\$13.99



Small-Scale Spill Containment Tray

You'll want to use this multipurpose HDPE containment tray in your workshop, mud room or under your machinery - anywhere you need to contain fluids and debris. Holds four pairs of boots or 5 gallons of liquid. Ribbed bottom. Black color. Measures 36"L x 18"W x 2"D.

Item #	Price
150179	\$25.99



SELLARS EverSoak® Medium-Duty Sorbent Socks

General purpose sorbent socks for everyday use

Stop machinery leaks, drips and spills from becoming a safety hazard. General-purpose absorption of water, diesel fuel, transmission fluid, coolants, grease, paint and more. 70% recycled cellulose fibers. Box of 40.

Item #	Price
225611	\$81.99



Cellulose Sorbent Socks and Pillows

Spilfyter Cellulose Sorbent Socks absorb all types of non-aggressive spills

Absorb leaks in small or confined spaces and are easily shaped around drums, tanks or pipes. Pillows are ideal for picking up water, oil, coolants and other mild chemical leaks.

Item #	Length	Width	Price
126744	4'	3"	\$35.99
126747	10"	10"	\$44.99
126748	18"	18"	\$61.49
126745	4'	3"	\$82.99



Revolution Series SlimLine Recessed Traffic Cones

Smaller footprint lets you store more in a smaller area

Narrow profile takes up less space without sacrificing visibility. Grooved, grab-n-go rim acts like a handle and gives you a place to attach barricade tape. (Also stays vibrant, thanks to injection molding and UV stabilizers. Patented interlocking base is made of 70% recycled material and securely attached to the cone. A recessed area makes the cones easier to separate when stacked. Meets MUTCD and NCHRP-130 crash requirements.

Item #	Height	Color	Reflective	Price
230378	20"	Orange	No	\$13.99
230379	28"	Orange	Yes	\$18.99



Revolution Series Reflective Traffic Cones

Reflective, more durable and more flexible than traditional flow-molded traffic cones. Reflective Cones include 3M prismatic material that reflects light for visibility at any angle. 230374, 230376 and 230377 have a recessed topical area that offers protection to the reflective material. An indented handle on each makes them easier to pick up by hand and gives you a way to attach barricade tapes or chains. Patented interlocking base (made from 70% recycled content) won't separate from the body, even under extreme stress such as being run over by a car. UV stabilized to stand up to the elements. No white liner or fading issues. Premium-grade injection molded PVC springs back to its original shape after being crushed.

Item #	H	Color	Reflective	Price
230372	18"	Orange	No	\$15.99
230373	18"	Lime	No	\$17.99
230374	38"	Orange	Yes	\$26.00
230375	36"	Lime	Yes	\$28.99
230376	30"	Orange	Yes	\$33.99
230377	30"	Lime	Yes	\$35.99

Traffic Cone Signs

ABS plastic has longer life than aluminum signs. Highly visible signage in ideal way to alert motorists of changing driving conditions and make work sites safer for employees. Use sign on roads, highways, parking lots—anywhere traffic control is needed. Injection-molded 10 1/2" x 11 1/2" signs fit all traffic cones and standard universal posts. (Cones and posts sold separately). No tools necessary. UV-treated, weather-resistant, 1/2" thick ABS plastic for long life in extreme weather conditions.

Description	Price
Case Sign	\$13.99



Retractable Cone Bar

Use with PVC cones to create a barricade

Use with any set of PVC traffic cones to create a fast, unique barricade or even a square barrier system. From 2' x 3' or 4' x 4' in seconds. Exterior-grade PVC with UV resistance. Has three 4" high-intensity reflective colors. Fully extends from 5' to 8' with unique proprietary locking mechanism. Traffic cones sold separately.

Item #	Price
123461	\$27.99





Cortina **A-Frame Barricade**

A-Frame Barricade directs traffic, keeping vehicle or pedestrian traffic out of areas that are off limits

Durable polypropylene and PVC construction. I-beams fit securely in the A-Frame sides, feature striped reflective sheeting. Quick and easy assembly. Meet MUTCD Type I and Type II for barricade devices.

Item #	Length	Beam Type	FT	Price
211852	96"	2	*	\$119.99
211854	72"	1	*	\$67.99
211853	96"	1	*	\$75.99

*Item ships by Truck due to size and weight.



Cortina **Plastic Barricades**

1 or 2 Panel Plastic Barricades are ideal for crowd or traffic control

Barricades are made with high-density polyethylene with engineer-grade reflective striping that stands up in harsh environments for years of use. Panels are double-sided and have engineer-grade reflective sheeting for added visibility. Designed with wide legs for stability. Meets MUTCD and NCHRP-350 standards. Add weatherproof flashing lights for extra visibility (sold separately). All signs are double-sided. NOTE: Type II barricade has two panels, Type I barricade has one panel.

Item #	Color	Description	Price
214566	Yellow	6VDC Barricade Light w/Photo Cell	\$18.99
214563	Orange/White	Type I Barricade	\$55.99
214562	Orange/White	Type II Barricade	\$69.99



Cortina **Stackable Channelizer Cone**

Stackable Channelizer Cone features a tapered design for easy to stack and convenient for transport

Rugged, recycled rubber bases (sold separately, Item #s 212209 and 212210) offer stability and support as well as skid resistance.

NOTE: 42"H cone comes with (1) 4"W and (1) 6"W stripe. Depending on style, 49"H cones come with either (4) 4"W stripes or (4) 6"W stripes.

Item #	Description	Height	FO	Price
212209	Base	2-3/8"		\$11.99
212204	Cone	49"	■	\$24.99
212205	Cone	49"	■	\$24.99
212208	Cone	42"	■	\$24.99
212207	Cone	49"	■	\$34.99

■ Oversize item: additional shipping charges will apply.



Triangular Warning Kit

Keep this Triangular Highway Warning Kit in your vehicle for on-the-spot road safety

Contains three 17" triangles packed in a molded plastic case, along with setup specifications. Fluorescent orange inner triangles provide daylight visibility. Red outer triangles reflect at night. Triangles snap together; plastic base holds triangles in place even in high winds. Meets FMVSS 125.

Item #	Price
26649	\$26.99



Blaze Orange Mesh Safety Flag

Mesh design allows for use on fast-moving vehicles. Fluorescent orange, vinyl mesh flag is mounted on a 27" x 3/4"-dia. hardwood staff. 18" x 18" flag resists cracking, peeling and fraying caused by wind whipping.

Item #	Price
STF3	\$5.99



"Mowing Ahead" Folding Barricade Sign

"Mowing Ahead" portable folding barricade sign informs drivers, cyclists or pedestrians of traffic changes

This "Mowing Ahead" portable folding barricade sign provides a clear warning message to drivers, cyclists and pedestrians. This recyclable sign is made from durable, 100% polypropylene and is completely UV resistant to prevent deterioration from the sun's harmful rays. Easy nesting and stackability. Panel measures 12"W x 24"H. Overall dimensions are 24"W x 36"H.

Item #	Description	Price
214456	Mowing Ahead	\$69.99
214454	Men Working	\$69.99



Drum Traffic Control Barrel

Tapered barrel alerts drivers to hazards in roads, sidewalks and parking lots

Barrel accommodates most barricade lights and is designed for easy pick up. 18-1/8" dia. across the top, 23" dia. across the bottom. 41-1/4"H (without base). Meets NCHRP350, MUTCD. Optional base ring (sold separately) for added stability.

Item #	Description	FO	FT	Price
216929	Weighted Base	■		\$5.99
216928	Traffic Barrel		*	\$74.99

*Item ships by Truck due to size and weight.

■ Oversize item: additional shipping charges will apply.



Reflective Fiberglass Property Markers

3M™ engineer-grade silver reflective tape strip

Low-cost, reflective sticks clearly mark property edges to help prevent damage from snowplows and warn visitors of hazards like culverts or ditch lines. Brilliant marker colors are easily visible in low-light conditions or bad weather and against many backgrounds like snow, blacktop, wooded or grassy areas. Fiberglass stick is flexible, yet very durable. 5/16" dia. Tapered bottom makes insertion easy. Pkg. of 12.

Item #	Color	Stake Length	FO	Price
G10800	Orange	4'	■	\$38.59
156297	Yellow	4'	■	\$42.99
125716	Orange	6'	■	\$66.59

■ Oversize item: additional shipping charges will apply.



Highly Reflective 5'H "T" Posts

Help prevent damage to your lawn and/or landscaping using these "T" posts with permanently applied reflective tape. Mark trails, driveways, parking lots, hazardous sections of road, ditches or culverts. D.O.T. retroreflective tape provides visibility up to 1/2 mile away. Made of rust-resistant PVC. Install using a rubber mallet or post driver. Specify color.

Item #	FO	Price
149739	■	\$12.49

■ Oversize item: additional shipping charges will apply.

- Lime
- Red/
White
- Orange



DOT-Grade 5.5'H Fiberglass Marker

Mark driveways to prevent accidents and protect equipment. Extremely durable marker springs back from accidental run-overs. Marker measures 5.5'L x 3-15/16"W. Open end of Post Driver (sold separately) allows markers to fit securely. NOTE: Customize your posts with tapes/numbers sold separately at gemplers.com.

Item #	Description	FO	Price
134474	Post Driver		\$183.99
FM60	Marker	■	\$24.69

■ Oversize item: additional shipping charges will apply.



Re-bouncer™ Delineator Post

Never worry about snapped-off delineator posts again

Re-bouncer Delineator Posts bounce right back into place when they're struck. 28"H.

Item #	Price
211736	\$23.99



18" x 12" Aluminum Traffic and Property Signs

Reflective signs meet MUTCD Standards

Heavy duty, .080" aluminum with engineer-grade reflective surface provides added visibility in low light conditions. Signs printed with UV resistant ink to prevent fading. Withstand the harshest weather conditions. Rustproof. Moles punched in the center on the top and bottom allow mounting on posts with holes on 1" centers. **NOTE:** Posts sold separately.

Description:	Price:
Aluminum Sign	\$35.99

Find more signs at gumples.com



162365

162366

Reflective Road and Highway Marking Signs

Highly visible signs get your message across—night or day

Even the harshest weather conditions are no match for these rugged signs. Constructed from reflective sheeting on .080" thick aluminum, signs are designed to last for years.

Description:	Price:
Reflective Road Sign	\$56.99

All signs are 24" x 24", except as noted.



131041HIP

130937HIP

130476HIP

131344HIP

42219



24471

Steel Sign Post

Steel is more economical than fiberglass

U-channel steel post is 71/2" x 3/4" by 11 feet in 11 sections. Can be used with 18" x 12" aluminum traffic control signs (sold separately).

Anti-Theft Steel Bolts – Make your sign practically impossible to steal. Easy sign installation requires no special tools. Once installed, these hardened steel bolts are impossible to grip with a bare hand. Includes (7) 2-1/2" x 1/2" S/W bolts, (3) nuts and (2) washers.

Item #	Description	Price
42219	71/2" Sign Post	\$15.99
24471	Anti-Theft Sign Bolts	\$9.99

Green U-Channel Sign Posts

Mount signs on front or back

Best sign posts you can trust to stand there ground. Made of 100% high-carbon steel, U-channel posts are up to 25% stronger than competitors. Mount signs front or back thanks to a patented ribbed-back design. Installation is fast and easy — no fancy tools required. 1/2" U/W. NC/HP 250 compliant.

Item #	Length	Price
218726	7'	\$16.99
218727	8'	\$22.99
218728	11'	\$29.99





Personal Protection Signs

Keep important safety messages visible

Made from adhesive vinyl, polyethylene or aluminum. All are resistant to scratching and fading. Call 1-800-382-8473 for a custom sign quote. Specify size and material. **NOTE:** Some options not available in all geographical areas.

7" x 10"	Price
Self-Adhesive Vinyl	\$4.79
Paper	\$7.49
Aluminum	\$11.49
10" x 14"	Price
Self-Adhesive Vinyl	\$6.79
Paper	\$12.49
Aluminum	\$19.99



AccuFORM Signs

10" x 14" Graphic Alert Signs

Easy-to-interpret signs communicate your safety message immediately

Provide employees and visitors with extra information for accident prevention and protection. Graphics on each sign communicate the message clearly, even to those who don't speak English. Available in adhesive vinyl, paper, or aluminum. Meets OSHA 29 CFR 1910.145 standard for accident prevention signs. Specify correct adhesive vinyl. Made in aluminum.

Material	Price
Adhesive Vinyl	\$6.79
Paper	\$11.79
Aluminum	\$18.79



GEMPLERS 10" x 14" High-Density Signs

Durable and impact resistant

Signs are made of 0.5 lbs. polyethylene and resistant to cracking, breaking or weathering. Best for outdoor or blast-bomb resistant use. **NOTE:** Item # 127507 Slow Down Signs 24" x 36"

Description	Price
10" x 14"	\$13.49
24" x 36"	\$32.49

14" x 10" English/Spanish Signs

An easy way to alert employees

Most visible advertisement that will be understood by either English- or Spanish-speaking people. Signs are made of adhesive vinyl, polyethylene or aluminum. Specify material. **NOTE:** Item # 219124 "No Smoking" signs, 14" x 10". Some signs are not available in all material options.

14" x 10"	Price
Adhesive Vinyl	\$6.79
Plastic	\$12.49
Aluminum	\$18.79

36" x 8"	Price
Adhesive Vinyl	\$8.79
Plastic	\$12.49
Aluminum	\$24.99



219124

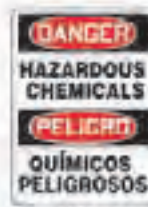

219125



219126



219128



219129



219130



219131



219132



219133



219134

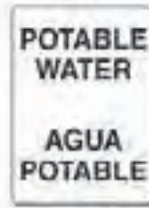

219136



219117



219138



219139



219140



219141



219145



219151



219152



219156



219158



219159



219160

6" x 5" Glow-in-the-Dark Projecting Wall Signs

Visible during power outages or low light conditions

Charged by low light source, they glow in the dark and project at a 45-degree angle from the wall, making them visible from up to 100' away. They illuminated for as long as 10 hrs after the lights go out. Made of tough, high-impact plastic, that's 1/8" thick. Pre-drilled mounting holes, self-adhesive pads, mounting screws and washers for easy installation.

NOTE: Item # 131637V "EXIT" sign is 4 1/2" x 7 1/2"

Description	Price
Wall Sign	\$32.49



131721V

Pre-drilled holes allow easy installation



131635V



131683V



131606V



131637V



JJ KELLER Federal Labor Law Poster

Keep your employees informed of their rights while protecting your company from large fines with this Federal Labor Law Poster

This Federal Labor Law Poster combines the five required notices; Employee Polygraph Protection Act, Job Safety and Health Protection, Federal Minimum Wage, EEOC Regulations and Family Medical Leave Act. Poster is laminated and measures 20"W x 26"H.

Item #	Description	Price
166338	Spanish Poster	\$34.39
166337	English Poster	\$34.99



BRADY OSHA Record Keeping Center

Brady Prinzing OSHA Record Keeping Center keeps records organized to stay in compliance

Brady Prinzing OSHA Record Keeping Center provides all the materials you need to prepare, maintain and post records of work-related illnesses and injuries. Meets OSHA requirements for companies of 11 or more employees.

Item #	Price
214611	\$139.99



Right-to-Know Plastic SDS Poster

HCS 2012/GHS format

This 20"H x 32"W flexible plastic poster provides employees with an information summary from the GHS standardized 16-section SDS. Includes information about products, company identification, hazards identification, first aid measures and more. Make sure to hang this poster in a prominent location for easy reference to new SDS formatting.

Item #	Price
222417	\$52.99



GEMPLERS Bilingual "Posted - Private Property..." Sign

Low-cost sign distinguishes property borders and restricts unwanted entry

This Bilingual "Posted - Private Property" Sign is printed on high-visibility yellow, 0.024-ga. plastic sheeting that will withstand years of exposure to the elements. Landowner or lessee signs to authorize the posting. Sign measures 11-1/4" x 11-1/4". Yellow background with black lettering. Sign reads: Posted Private Property Trespassing is strictly forbidden.

Item #	Language	Price
VPS	Bilingual	\$2.49
VVPS	English	\$3.79



HY-KO 12" x 12" Tyvek® Private Property Signs

Notify others of your property boundaries with these weatherproof, easy-to-post warning signs

These 12" x 12" yellow "Private Property" signs are made of Tyvek for durability in all types of bad weather. The Tyvek material is tear resistant, yet easy to post on trees or wooden posts with a staple gun. Roll of 100.

Item #	Price
TRY12	\$62.99



Blackburn Economical Grounds Maintenance Flags

Alert others about new pesticide applications

4-mil vinyl flags measure 5"W x 4"H and are mounted on a 24"L x 1/8"-dia PVC plastic staff. Black lettering on yellow. Pkg. of 50.

NOTE: Available with your company logo imprinted. Contact our sales team at 1-800-382-8473.

Note: not for sale in (WI).

Item #	Price
BF92	\$8.79





GEMPLERS WPS Warning Signs

Signs have appropriate WPS legend and legend size. Space is provided on the 21" x 14" sign for pesticide used, date of application and when the Restricted Entry Interval (REI) expires.

NOTE: This sign does not meet California WPS requirements.

Item #	Description	Size	Price
109821	Self-Adhesive Decal	16"x14" Standard Field Warning Sign	\$3.89
D2310	Low-Cost Plastic	16" x 14" Standard Field Warning Sign	\$4.89
D2398	Low-Cost Plastic	21" x 14" with application data	\$4.99
D1895	Corrugated Plastic	16" x 14" Standard Field Warning Sign	\$7.39
D1895	Corrugated Vinyl	16" X 14" Standard Field Warning Signs	\$8.59
D1899	Corrugated Plastic	21" x 14" with application data	\$9.49



NEW

GEMPLERS

English/Hmong WPS Warning Sign with Application Data

EPA-approved, bilingual, 14"W x 21"H sign quickly alerts others to recent pesticide applications with room to provide specific information including pesticide used, date of application and when the Restricted Entry Interval (REI) expires. Wind- and weather-resistant. NOTE: This sign does not meet California WPS requirements.

Item #	Price
D2019	\$5.99



Galvanized Sign Holder

Posting your message is a cinch with this easy-to-use Galvanized Sign Holder

Edges are crimped in three places to hold signs in place. Simply nail or screw to a post through the provided holes. Bend crimped edge to accommodate various sign thicknesses.

Item #	Holder Size	Price
211845	16" x 14"	\$10.79
211846	21" x 14"	\$15.19



GEMPLERS

Hinged WPS Bilingual Warning Sign - "Danger - Pesticides"

This EPA-accepted, hinged sign is the perfect solution for areas frequently treated with pesticides

Easily snap in half, then insert binder rings through the pre-punched holes. When posting is required, simply flip up top half of the panel for sign to show. Color and legend meet WPS requirements. 14"W x 16"H.

NOTE: This sign does not meet California WPS requirements.

Item #	Price
D2000	\$10.49



GEMPLERS

WPS Bilingual Warning Sign with Application Data - "No Trespassing"

Easily snap in half, then insert binder rings through the pre-punched holes. When posting is required, simply flip up top half. Meets WPS requirements. Reads "DANGER - PESTICIDES - KEEP OUT" when open and "POSTED - NO TRESPASSING" when closed. 21" x 14".

NOTE: This sign does not meet California WPS requirements.

Item #	Price
D2020	\$14.29



GEMPLERS

14"W x 16"H Field Warning "No Trespassing" Sign

This EPA-accepted, hinged sign is the perfect solution for areas frequently treated with pesticides

Easily snap in half, then insert binder rings through the pre-punched holes. When posting is required, simply flip up top half of the panel for sign to show. Color and legend meet WPS requirements.

NOTE: This sign does not meet California WPS requirements.

Item #	Price
D2010	\$13.49

GEMPLER'S Pesticide Warning Signs

Reusable signs are ideal for use in individual potted plants, small containers and greenhouse benches. #139200 sold 25/pk. #2256 sold individually.



GEMPLER'S California Field Posting Sign, 14"W x 16"H

Meets California field posting requirements initiated in 1997. Weather-resistant sign is constructed of .030-ga. polyethylene with UV inhibitors.

Item #	Price
D1212	\$4.89



GEMPLER'S Nursery and Greenhouse Signs

Made from reusable, weather-resistant corrugated plastic. Signs and stakes are sold in packs of 25.

Item #	Description	Price
222378	5" x 5" Signs	



GEMPLER'S Fumigant Buffer Zone Sign, 14"W x 21"H

Plastic sign complies with Phase 2 fumigant labels. Features: "Do Not Enter" wording, fumigant/product name, "Fumigant Buffer Zone" wording and contact info for the certified applicator.

Item #	Price
214580	\$7.49



GEMPLER'S Bilingual Warning Sign, 14"W x 21"H

Warning sign is EPA-accepted and warns of fumigant applications. Sign reads: Danger Area Under Fumigation Do Not Enter. Sign's ink and .030-ga. plastic are treated for a long outdoor life.

Item #	Price
V600	\$6.79



GEMPLER'S Pesticide Warning Sign, 14"x14"

Keep people out of harm's way with this octagon-shaped sign. Printed with outdoor-grade, UV-resistant inks on .030-ga. polyethylene for superior durability.

Item #	Price
D987	\$9.99



GEMPLER'S Do Not Spray Sign, 14"W x 16"H

Sign warns not to spray organically grown crops. Made of weather-resistant .024-ga. polyethylene.

Item #	Price
G10182	\$6.29



GEMPLER'S Step-In Wire Sign Stakes

Simply step on the 9-ga. galvanized wire frame to drive it into the ground, then slide a corrugated sign on to the upright posts.

Item #	Description	Price





GEMPLER'S Record System For Posting Pesticide Applications

Write-On/Wipe Off Wall Poster - 25"x18" laminated WPS Pesticide Poster is waterproof to last for many seasons. Allows you to make changes to data. Pesticide Application Posting Sheets - Tablet has 50, 8.5"x11", three-hole punched sheets you can fill in and post. Three Ring Binder - 1.5" bright yellow, hard plastic three-ring binder stores 8.5"x11", 50-count paper pads. Steel Wall Rack - PVC coated to protect it from the elements.

Item #	Description	Price
GR20	Three-Ring Binder	\$13.89
198392	Steel Wall Rack	\$19.49
P942	Wall Poster	\$6.99
T8919	Pesticide Application Posting Sheets	\$6.99



GEMPLER'S Pesticide Safety Poster

Updated poster meets new EPA WPS requirements

Pesticide safety poster is required to be displayed at a central location on agricultural establishments. This full-color poster must be readily accessible at all times during normal work hours and be easily seen and read by workers and handlers. Clearly identifies emergency medical contact information. 32"H x 23"W.

Item #	Type	Price
230033	Laminated	\$10.69
230032	Cardstock	\$6.29

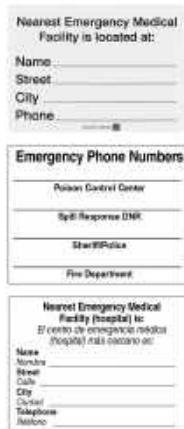

GEMPLER'S 10" x 14" Emergency Information Signs

This Gempler's Required Emergency Information sign measures 10"W x 14"H and is made of exterior-grade plastic. Contain the required posting information for the nearest police, medical, fire and "other" emergency facilities, including the name, street address, city and phone number.

Item #	Description	Price
X1597	Optional Information	\$11.49
X1584	Required Information	\$11.79
X1594	Spanish/English	\$11.79



GEMPLER'S EPA How to Comply Guide

You should read this manual if you employ agricultural workers or handlers, are involved in the production of agricultural plants as an owner/manager of an agricultural establishment or a commercial (for-hire) pesticide handling establishment, or work as a crop advisor.

Item #	Price
EPA7	\$9.99



GEMPLER'S WPS Pesticide Application Records Center

Keep all of your important pesticide information together and in one place

This convenient Records Center keeps important information organized and all in one place. In most cases, retention of these posted sheets will satisfy the USDA's "Restricted-Use Pesticides" record keeping rule. Record Center includes: (50) 8.5" x 11" pesticide application posting sheets; (1) 1.5" three-ring binder; (1) PVC-coated binder rack.

Item #	Price
GR100	\$35.49



BRADY Right-to-Know SDS Binder Center

Store chemical Safety Data Sheets in one location

Keep your employees safety information up-to-date and readily accessible with these Right-to-Know binder centers. These centers meet compliance requirements for Globally Harmonized System (GHS) and OSHA Hazard Communication Regulation 29 CFR 1910.1200.

Item #	Language	Price
222405	English	\$72.99
222404	Spanish	\$74.99



GEMPLER'S Safety Data Sheet Binders

Three-ring binders are attached to a 36"L chain, making Safety Data Sheets easily accessible. Heavy-duty, thick plastic cover is a highly visible yellow. 1-1/2" thick binder stores 360 pages sized 8.5 X 11". 2-1/2" binder stores 500 pages. Use metal storage racks (#198392) to wall mount the binder. Meets right-to-know compliance standards.

Item #	Language	Safety Supplies: Size	Price
222426	English	1-1/2" Binder	\$12.99
222427	English	2-1/2" Binder	\$12.99
222440	Bilingual	1-1/2" Binder	\$14.29
222447	Bilingual	2-1/2" Binder	\$14.29



GEMPLER'S Pesticide Record Keeping Forms

Easy-to-use form/pad complies with all EPA and USDA record keeping requirements. Each carbonless form has: a white, "field copy" for the applicator; a yellow, "permanent spray record" copy; and a pink, "WPS central posting" copy. Pad has 50 forms (3-hole punched) and a built-in separator page. 11-3/4"L x 8-1/2"W x 5/8"D.

Item #	Price
229896	\$19.99



Multi-Purpose Dry Chemical Fire Extinguishers

Protect your property from most types of fires

Respond to class A, B and C rated fires quickly and effectively with tri-class dry extinguishers. Siliconized mono ammonium phosphate dry chemical is 4 to 5x as effective as an equal weight of weight on Class A fires. Use to combat fires in ordinary combustible materials such as wood, cloth, paper, rubber and many plastics (class A); flammable liquids, gases and greases (class B); and fires involving energized electrical equipment (class C). Cylinders are constructed of dependable drawn steel and are 100% hydrotested to 600 psi. Metal pull ring prevents accidental activation. UL, USCG-approved.

NOTE: The 2.5-lb. extinguisher includes a vehicle mount bracket. The 5-, 10- and 20-lb. extinguishers include a wall-mount bracket.

Note: not for sale in (AL;GA).

Item #	Description	Capacity	HM	Price
1123	Fire Extinguisher	10 lb.	▲	\$114.99
8774	Repl. Vehicle Mounting Bracket	2-1/2 lb.		\$12.99
5467	Repl. Vehicle Mounting Bracket	5 lb.		\$13.99
3820	Fire Extinguisher	20 lb.	▲	\$200.99
1123	Repl. Vehicle Mounting Bracket	10 lb.		\$49.99



Fire Extinguisher Cabinets

Protect and identify extinguishers

Lightweight, injection-molded ABS plastic is dent and corrosion resistant. Fire extinguisher verbiage on sides and translucent cover make identification easy.

Instructions for use are clearly marked on cover handle. Inside dimensions are 23-1/2"H x 9"W x 6"D. Covers include padlock and key to guard against theft or unnecessary use. Fire extinguisher not included.

Item #	Description	Price
151381	Replacement Clear Cover	\$19.99
151380	Replacement Red Cover	\$21.99
151377	Red Cabinet w/ Clear Cover	\$50.99
151376	Red Cabinet w/ Red Cover	\$51.99

- Red
- Clear



Fire-Related Signs

Provide critical safety information

Plastic signs are exterior-grade polyethylene.

Item #	Description	Price
219098	10"W x 7"H Aluminum Exit Sign	\$11.49
X122	4"W x 24"H Plastic Fire Extinguisher Sign	\$12.49
X623	4"W x 24"H Plastic No Smoking Sign	\$12.49
219098	10"W x 7"H Adhesive Vinyl Exit Sign	\$4.79
219098	14"W x 10"H Adhesive Vinyl Exit Sign	\$6.79
219098	10"W x 7"H Plastic Exit Sign	\$7.49

FIMCO® UTV Sprayer
with 7-Nozzle Booms
227666 on pg. 138



Sprayers

It's always smart buying your sprayers at Gempler's — we carry brands that deliver long-lasting, safe and smooth operation, plus we stock all the parts you may need in the future. Whatever safety clothing your crew needs for their spraying jobs, we've got that too. And remember, good advice is always just a toll-free call away, at 1-800-382-8473.



Solo® 4.5-gal. Battery-Powered Backpack Sprayer
228341 on pg. 121



FIMCO® 12V Deluxe Sprayer, 25. gal.
147753 on pg. 127



Gempler's® 1-gal. Spray Tank Cleaner
PL10 on pg. 145

GEMPLER'S®

**FIMCO
INDUSTRIES**

solo®

TOP BRANDS

jacto

**Kings
Sprayers**

**TeeJet
TECHNOLOGIES**

CHAPIN

Solo® Parts	111-112
Handheld Sprayers.....	113-115
Backpack Sprayers.....	116-126
ATV & Spot Sprayers.....	127-129
Trailer Sprayers	130-132

Three-Point Sprayers.....	133-134
Skid & Other Sprayers	135-138
Parts & Accessories.....	139-150
Herbicide & Pesticide	151
Measuring & Calibration	152-154

Keep your Solo[®] sprayer in tip-top shape

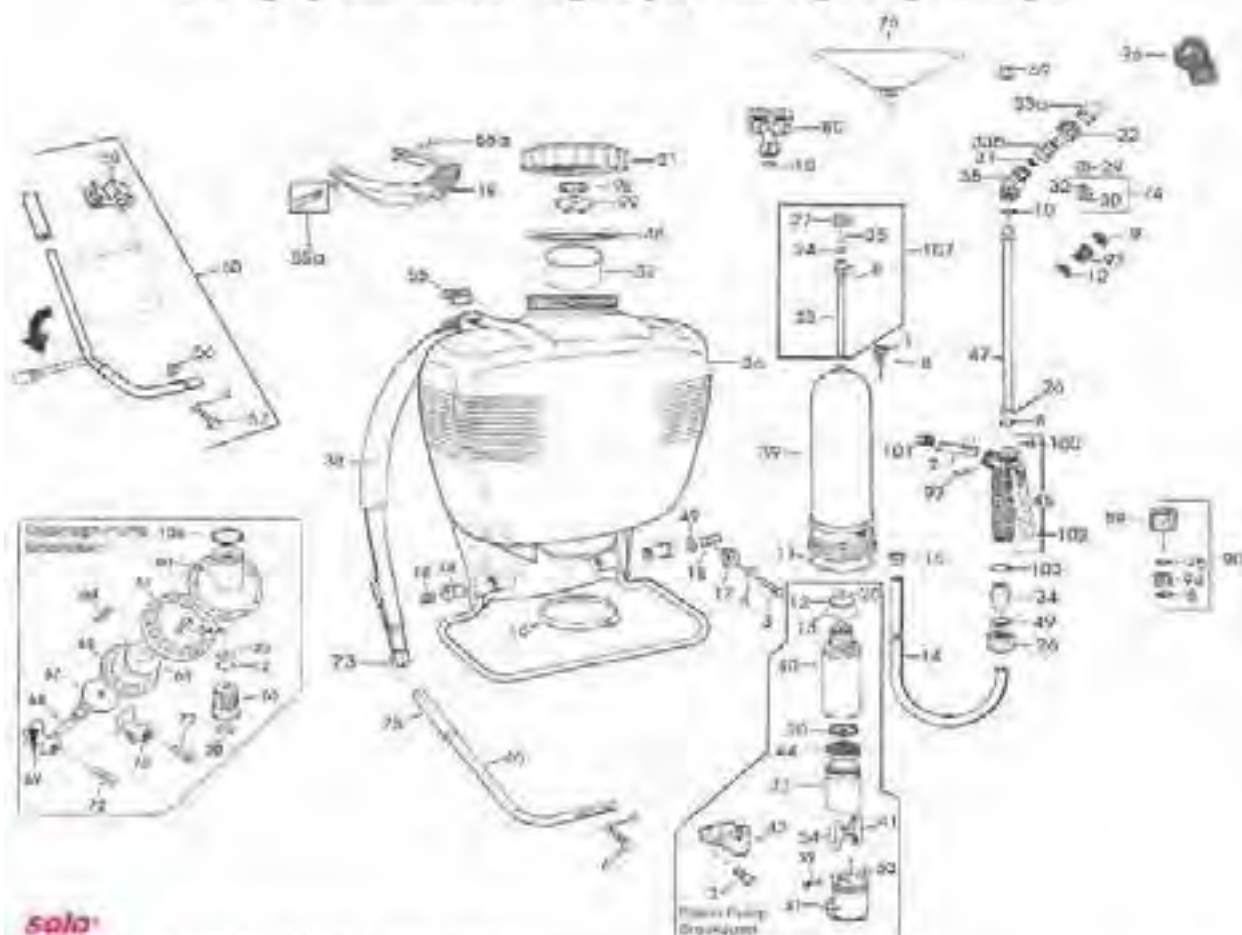

solo

Parts for Model 425, 471, 475 and deluxe backpack sprayers

(Use the drawing above to match the part's description to the item number at the start below. All parts are manufactured by solo.)

Item #	Description	Qty	Price	Item #	Description	Qty	Price
4200215	Plastic Tank	1	\$6.79	4074263	Flap Spring Kit	21	\$4.29
0010165-1	Bolt	1	\$2.99	4074755	Swirl Nozzle	10	\$2.34
0012185-1	Bolt	1	\$2.99	4074283	Leaf Nozzle	11	\$4.19
0030131-1	Washer	1	\$2.99	4074755	Jet Cap	11	\$3.04
0012185-1	Bolt	1	\$2.99	4900527	Plastic Adjustable Nozzle (No. 40)	33	\$6.99
0610402X-1	Quick Valve Repair Kit	1	\$4.40	4074500	Tank Seal	34	\$4.29
0062258-1	Coilnut	3	\$3.79	4074527	Elbow	35	\$4.40
0062106-1	O-Ring	5	\$3.19	4200162	4-Gal. Tank and Hose Assy.	36	\$23.99
0062115-1	O-Ring	10	\$3.99	4200166	Flux Tube	37	\$9.49
0062291-1	O-Ring	11	\$4.59	4300315	Shoulder Strap (No. 17) (1)	38	\$7.29
0062139-1	O-Ring	12	\$3.79	4400240	Pressure Cylinder (No. 10) (1)	39	\$20.59
0062140-1	O-Ring	13	\$3.29	4400188	Plastic Cylinder Assy. (Nos. 12, 13, 20) (1)	40	\$24.09
0004234-1	40" Hose (No. 10, 15, 16, 17) (1)	14	\$18.49	4074409	Connecting Hose Assy.	41	\$3.19
0066388-1	Rose Lamp	15	\$5.99	4074262	Lever	42	\$6.19
0066394-1	Carriage	16	\$9.49	4073558	Pin	43	\$12.99
4043123	Stop Pin	17	\$4.79	4400189P	Wash Coat	44	\$14.99
4035111	Pump Pin	18	\$2.99	4800170P	Shoulder Strap Assy.	45	\$20.79
224507	Carrying Handle	19	\$12.99	4800173	Pump Lever (No. 1) (1)	46	\$20.49
4061257	Valve Pin	20	\$5.00	4900230P	Spray Wand	47	\$13.49
4200242	Tank Cap (Nos. 40, 45, 46) (1)	21	\$10.99	160099	Tank Top O-Ring	48	\$4.29
4074148	Retaining Nut	22	\$5.99	0013356-1	Washer	49	\$2.09
4074323	Valve Body	23	\$6.29	4900454	Fold Away Handle (No. 4) (1) (1)	50	\$13.99
4074350	Sealing Plug	24	\$2.79	4074677	Protective Foam	51	\$4.79
0070260-1	Compression Spring	25	\$3.69	0010110-1	Pin	52	\$2.99
4074337	Retaining Nut	26	\$3.29	0020101-1	Nut	53	\$2.99
4074344	Control Knob	27	\$4.29				
4074410	Bushing	28	\$2.59				

Continued on next page

Continued from previous page

Solo® Parts for Model 425, 473, 475 and deluxe backpack sprayers

Item #	Description	Qty	Price	Item #	Description	Qty	Price
4074408	Connecting Nut w/ O-ring	54	\$3.19	4900252	Hollow-Cone Jet Nozzle	74	\$3.99
4074412	Buckle (for 2013 models)	13	\$3.19	4074302	Grip	75	\$6.59
224506	Strap (for 2013 and later models)	59	\$2.79	4900106	Orbit Guard	76	\$19.99
0020119-1	Nut	56	\$1.59	4900100	Twin Spray Nozzle	89	\$29.99
0012192-1	Bolt	57	\$2.99	4065189	Pressure Gauge Guard	92	\$5.79
4074956	Clip	58	\$3.29	4900356	Pressure Gauge	93	\$39.99
0065210-1	Spout Jet Spray Nozzle	59	\$4.99	2700316	No-clip Check Valve	93	\$9.99
4073411	Diaphragm Housing	60	\$12.99	4074338	Re-Lining Nut	94	\$6.49
4073410	Flange	61	\$9.99	0062249-1	O-Ring	95	\$2.29
4400222	Wet-A-Wax (16oz. 12.50 fl.oz.)	61	\$14.59	217724	Spray Tip Nozzle	96	\$9.99
224174	Diaphragm Screw	63 (4-4)	\$1.59	4074295	Pin	97	\$2.49
4074247	Plunger	65	\$5.99	4061464	Wet Plate	98	\$2.29
4074245	Diaphragm	66	\$9.99	4074123	Vert. Cap	99	\$1.99
4074233	Leak	67	\$4.99	4074129	Lock Clip	105	\$3.29
4031130	Wash Pin	68	\$5.99	4074336	Welding Nut	103	\$3.99
4074243	1" Connecting Bracket	68	\$3.59	4074335	Leak	102	\$7.29
4074234	W/ Connecting Bracket	70	\$3.59	0062271-1	O-Ring	108	\$2.99
0010141-1	Risk	72	\$2.29	0062334-1	O-Ring	106	\$2.99
198656	Hook	73	\$5.49	224508	Pressure Control Valve	107	\$6.99

Accessories and Repair Kits

Item #	Description	Price
0610407K-1	Piston Pump Repair Kit (Nos. 7, 11-15, 20 (2 nos.), 24, 25, 44 incl.)	\$27.99
0610406K-1	Diaphragm Pump Repair Kit (Nos. 6, 11, 12, 20 (2 nos.), 24, 25, 44, 10 (var.))	\$20.99
167803	Piston Pump Assembly (Nos. 8, 11, 45, 20 (2 nos.), 39-44, 54 (107 incl.)	\$29.99
4400221	Diaphragm Pump Assembly (Nos. 9, 11, 12, 20 (2 nos.), 20 (no. 11), 14 (1 nos.), 34A, 10 (no. 11), 39, 39 (incl.)	\$29.99
4900310N	Conversion Kit from piston to diaphragm pump	\$30.99
0610411K-1	Wash Repair Kit (Nos. 7, 8, 10, 22, 26, 14, 48 (10))	\$13.99
0610409K-1	Wash Repair Kit (Nos. 40-44, 54 (10))	\$23.99
133675	Z" Plasti Weld	\$28.99
4900206	Adjustable Brass Spray Nozzle (Nos. 22, 31 and brass nozzle incl.)	\$9.99
0610456P-1	Nozzle Assembly (Nos. 22, 29-32, 40-43) Nozzles 2.0 and 2.5, and Hollow Cone Nozzle 2.8mm (10)	\$17.99
4900258N	Flow and Nozzle Assembly (Nos. 1, 11, 13a, 13b, 15 (1))	\$8.99
0610408P-1	Spray Blow and Nozzle Assembly (Nos. 8, 10, 22, 20-32, 35, 39 and No. 20 (2.8 nozzle) (1))	\$19.99
4900396	6FT. Back Spray Tube (No. 20 (1))	\$38.19
4900420	20FT. Extension Tube	\$17.99
171262	Deluxe Shoulder Strap Harness	\$29.99



Frequently Asked Questions

Backpack Sprayers

For more information with your Solo power and fluid water or other specialty wash questions, visit www.solopower.com or call 1-800-892-0473.

1. How far can I expect the sprayer to spray?

Solo backpack sprayers will spray up to 25'

5. I try to pump up my sprayer, but I can't get any pressure. What now?

Check the valve adjustment. The O-ring at the valve seat. Insure a 3/16" hole is drilled.

2. What kind of oil or grease should I use on the o-rings and seals of my Solo sprayer?

LIQUID SEAL-OIL. Deluxee grease (it performs better on O-rings and seals)

6. I still can't get any pressure. Any other suggestions?

If you have a piston pump, check to see if the ball in piston is worn. This may be necessary. Also, if you have a diaphragm sprayer, check the O-ring on the pressure control or diaphragm (1) repair if necessary.

3. Can I spray water sealant through my sprayer?

Yes, most types of water sealant can be used with your sprayer. All plastic consult your label for proper application methods.

7. How can I tell if I have a diaphragm or a piston pump on my sprayer?

Loosen the pump housing at the base of the sprayer. If the housing disassembles, you can see the pump held together by 12 brass screws. If a card ring joins it, the housing is a diaphragm. If a piston pump.

4. Will the replacement straps you sell fit the Solo sprayer I bought 10 years ago?

Yes, the strap we currently sell will fit on older models.



solo 441 Lithium ion Diaphragm Sprayer

A removeable and rechargeable lithium ion battery sprayer up to 4 hours on a single charge

Quiet 11V battery delivers 2.5 hours run time with 2 hour charge. Large 4.75" opening with removable filter basket. Wand is 28" and nearly unbreakable, and combined with 48" nylon reinforced high-pressure hose delivers a great reach. Speed Tip Nozzle features multi-spray patten and sprays with 3 different settings with a turn of the dial- jet stream, flat spray and full cone mist.

Item #	Price
193226	\$129.95



solo 460-Li USB Rechargeable 1 Liter Sprayer

USB rechargeable lithium ion hand sprayer

Flexible internal suction hose ensures a complete emptying of the tank and makes overhead spraying possible. Integrated lithium-ion battery runs for up to 60 minutes operation between charges. Charging time approximately 90 minutes.

Item #	Price
193227	\$29.95



solo Home & Garden Tank Sprayer

Full featured sprayer in an economical package

Use for general-purpose spraying, gardening applications and pest control. Also works great with wood deck cleaners, as well as algae and mildew removers. Durable 24" poly wand and shut-off valve assembly. 45" PVC hose. Plastic adjustable spray nozzle included. TeeJet® compatible. Large pump handle with a built-in wand retainer.

Item #	Description	Price
193222	1 gal.	\$16.95
193223	2 gal.	\$19.95



solo 2 Liter Home & Garden One-Hand Sprayer

Lightweight and versatile

These sprayers are perfect for general, at-home spraying both indoors and out, weed control, gardening, auto and marine, livestock applications and more. All offer many of the same features as our larger, professional sprayers. Chemical-resistant seals for use with pesticides. Large pump knob.

Item #	Price
193221	\$12.95



solo[®] 4.5 Gal. Semi-pro Batt. Backpack Sprayer, 11V Li ion

Solo battery powered backpack sprayers are free of emissions and whisper quiet

Impressive spray performance with quiet 11V pump. Maintenance-free 11V 7.2Ah lithium-ion battery fully recharges in less that 3 hours and provides up to 3.7 hours of running time. 4.5 gallon translucent tank is UV resistant. Equipped with a comfortable padded backpack support frame with wide padded shoulder straps.

Item #	Price
193228	\$249.95



solo[®] 3 Gal. Professional Tank Sprayer with Base & Inflation Valve

The most stable 3 gallon sprayer on the market includes an inflation valve

Chemical resistant Viton[®] seals in key locations withstand harsh chemicals for long service and durability. Pressure relief valve vents excess pressure. Commercial quality shut-off valve with lock-on/lock-off reduces fatigue. Large 4.5" tank opening for effortless filling and cleaning. Four nozzle assortment includes adjustable, flat fan, jet stream and hollow cone. TeeJet[®] compatible.

Item #	Price
193229	\$64.95



solo[®] Farm & Landscape Tank Sprayer

More features than other comparable brands for farm and landscape

Designed for medium-to-large jobs at home, on the farm, or for professional applications. Chemical resistant Viton[®] seals in key locations withstand harsh chemicals for long service and durability. Commercial quality shut-off valve with lock-on/lock-off feature reduces operator fatigue. Funnel top for easy fill and large secondary opening for easy clean-up. Four-nozzle assortment for multiple spraying tasks: plastic adjustable, fan spray, hollow cone, and jet stream nozzles. TeeJet[®] compatible. Unique storage compartment for extra nozzles. Adjustable webbed nylon carry strap makes carrying easy. Durable, high-density polyethylene (HDPE) tank, pump and sprayer parts. Ultra-violet resistant tank. Corrosion resistant. 28" nearly unbreakable wand and shut-off valve for excellent reach.

Item #	Capacity	Price
193224	1 gal.	\$29.95
193225	2 gal.	\$34.95



solo® 1.5 Gal. Industrial Pest Control Tank Sprayer, Viton® Seals

Designed specifically for the professional pest control operator

Includes 0.4 GPM 80 degree brass flat fan, plastic adjustable, jet stream, and hollow cone nozzles. TeeJet® compatible. No-drip check valve eliminates drip after pressure is released and all Viton® seals for superior chemical resistance.

Item #	Price
193231	\$54.95



solo® 2 Gal. CLEANLine Industrial Tank Sprayer, EPDM Seals

Designed with EPDM seals and O-rings for alkaline-based cleaning and de-greasing solutions

Fats, oils and protein residues are stubborn substances in the kitchen and food processing areas that require the application of alkaline cleaning solutions. These solutions are also used for cleaning glass, de-greasing components in the metal industry, or for cleaning jobs in the car industry. EPDM seals effectively protect connecting seams on SOLO CLEANLine Sprayers. Apart from alkaline cleaning solutions, EPDM is also suited for the application of disinfecting solutions such as those used in hospitals and swimming pools. To guarantee a long service life, all mechanical parts of the SOLO CLEANLine Sprayers are sealed to protect from coming into contact with the chemical. Special, high-quality nozzles ensure an even and consistent spray pattern.

Item #	Price
193232	\$69.95



solo® 2 Gal. CLEANLine Industrial Tank Sprayer, Viton® Seals

Designed with Viton® seals and O-rings for acid-based cleaning and disinfection fluids

Acidic-based cleaning fluids are used effectively in the commercial cleaning of buildings and in vehicle repair centers. They are also used to combat lime residues and deposits as well as germs, bacteria and much more. They are needed for the hygienic cleaning of medical rooms, baths and toilets, commercial kitchens, swimming pools, saunas, thermal baths and for cleaning plumbing fittings. These acidic solutions are a tough test for the seals and parts in the sprayer. Specifically built for this industry, the SOLO CLEANLine sprayers are equipped with Viton® seals and O-rings. These sprayers can also be used with solutions that contain oil or solvents. The pump systems are sealed to prevent these aggressive liquids from causing any mechanical damage. This contributes to a long service life.

Item #	Price
193233	\$69.95



solo® **Deluxe Shoulder-Saver Sprayer Harness**

The Solo Deluxe Shoulder-Saver Harness lets you stay productive during large sprayer jobs while keeping you comfortable

Get the back and shoulder support you need when working long hours with this Solo Deluxe Sprayer Harness. Wide, contoured and padded shoulder straps evenly distribute the sprayer's weight - lessen fatigue during lengthy spraying jobs. Weighs 0.6 lb.
NOTE: Sprayer shown is for display purposes only and is not included.

Item #	Price
171262	\$29.99



solo® **Standard Backpack Sprayers**

Spraying for weeds, insects and disease control doesn't need to be labor-intensive with this lightweight, portable sprayer

Supplied with four nozzles: flat fan, jet stream, hollow cone and plastic adjustable. Large 4"-dia. opening with strainer. Trigger lock allows continuous spraying. 60 psi (L425 and L435 spray up to 90 psi with optional plug). 20"L poly wand with 48"L hose

Item #	Price
L435	\$113.99
L485	\$114.99
L425	\$84.99
109877	\$89.99
109878	\$89.99
L475	\$99.00



solo® **Deluxe Backpack Sprayers**
Just what you need for spraying disinfectants, fertilizers and pesticides

Offers the same design as the popular standard models, but with added features. Extra-large, fold away carrying handle and wand retainer make transporting and storage easy. Include a durable professional-grade brass adjustable nozzle, 48"L hose, deluxe shoulder straps and waist belt.

Item #	Pump Type	Price
224513	Piston	\$112.99
224515	Diaphragm	\$113.99

BIRCHMEIER Externally mounted pump for easier maintenance

Remember the days when a backpack sprayer would give you many years of dependable service? Well, those days are still here with Birchmeier sprayers. Birchmeier has been around for more than 125 years, and their backpack sprayers are legendary for uncompromising quality and a long service life.

BIRCHMEIER Standard

Backpack Sprayers

Quality construction eliminates leaking include features not found on any other backpack sprayer. Like an externally mounted 15 gal pump (with brass cylinder to help eliminate leaking), adjustable piston seals, and external cylinder lubrication. 100% spray hole, hydraulic and Fluoroelastomer O-rings.

Item #	Size	Pump Type	Price
151246	2.5 gal	Hydro	\$274.99
151247	4 gal	Hydro	\$299.99

Find more Birchmeier parts at gemplers.com



Externally mounted pump with brass cylinder



On/off switch and pressure control



Unique disc belt allows for easy on/off

BIRCHMEIER Chip-Controlled Battery-Powered Backpack Sprayer

Efficient performance in an easy-to-use design

Electrically controlled piston pump acts like a motor sprayer, depending on the amount needed to be sprayed. Battery life is extended. Sprays from 20 to 120 lb, or a change depending on air setting. Use adjustable pressure from 7.25 to 87 psi. Or manual nozzle air valve. 10-1/2" brass wand with adjustable brass nozzle. 1/2-1/4" hose. Adjustable air flow. 1/2" diameter. 150 display for battery charge level. **NOTE:** While use of AA or B.

Item #	Size	Price
221767	4 gal	\$779.99

*Requires 4 AA or 4 B batteries (not included). See Gempler's website for more details.



BIRCHMEIER Replacement Parts and Accessories

Item #	Description	Price
Replacement Parts		
159941	Check Valve	\$19.99
159942	Curved Brass Wand	\$40.99
159943	Flow Control Valve (Includes hardware and filter screen)	\$113.99
159944	Lid Gasket	\$10.99
159945	Rubber Piston Ring	\$12.99
159946	Double-Acting Filter	\$138.99
159948	Hose	\$46.99
159949	Black Handle	\$17.99
159950	Valve Housing w/ Brass Nut	\$59.29
159951	Lock Insulate Clip-On Hose	\$25.99
159952	Wrist Shoulder Removable Hook (strap)	\$25.99
159939	Auto High-Flow Kit	\$19.99
159940	Valve Repair Kit	\$36.99
Accessories		
159947	Cylinder Grease (1 lb.)	\$5.29
159953	Reinforced Rip-Resistant Strapping Fabric	\$99.99
159954	Spay Head	\$61.99
159955	1/2-1/4" Control Flow Valve (yellow)	\$21.99
159957	20-1/2" Control Flow Valve (blue)	\$21.99
159958	40-1/2" Control Flow Valve (green)	\$21.99



NEW

Jacto PJB-8c 4 Gallon Battery Powered Backpack Sprayer

Like its bigger brothers the PJB-16 and 16c, the PJB-8c combines technology and ease of use in a very compact size. This 2.1 gallon shoulder mount sprayer is perfect for use in small plot growing, tight spaces such as greenhouses, border control in landscapes or plant-scape environments in office buildings. Equipped with a Lithium ion battery that will provide more than 2 hours of continuous spraying and comes with a separate charger that recharges in 6 hours or less. Pressure stays constant regardless of battery level.

Item #	Price
1230663	\$169.99



NEW

Jacto PJB-16c 4 Gallon Battery Powered Backpack Sprayer

The PJB-16c combines technology with ease of use, in a comfortable lightweight design and will be the sprayer of choice for herbicide applications. The PJB-16c is a 4.2 gallon compact, lightweight (7.7 lb), Lithium battery powered sprayer backpack sprayer. Equipped with a Lithium ion battery that will provide 2-4 hours of continuous spraying and comes with a separate charger that recharges in 6 hours or less. 53" reinforced chemical resistant hose, trigger valve with lock and strainer, 22" stainless steel wand with nozzle filter, and adjustable nozzle makes spraying an easy job.

Item #	Price
1230659	\$249.99



NEW

Jacto HH5 Compression Sprayer

This tough little 1.3-gallon (5 liter) capacity handheld sprayer features professional-grade trigger valve and lever – as well as a stainless steel spray lance. You won't find a better outfitted compression sprayer anywhere.

Item #	Price
1232231	\$29.99

**NEW**
jacto PJB-16 4 Gallon Battery Powered Backpack Sprayer

Consistent accuracy and efficiency for on-target delivery of their spray solution. The PJB-16 has a removable Lithium ion battery that will provide 8 hours or more of continuous spraying and comes with a separate charger that recharges in 4 hours or less. 5 pressure settings with pressure lock, audible walking speed indicator, LED display, auto shut-down, hydraulic venturi agitation and battery level indicator. 53" reinforced chemical resistant hose, field serviceable trigger valve with lock, 22" stainless steel wand with nozzle filter, and a four nozzle package makes spraying an easy job.

Item #**1230657****Price****\$349.99****NEW**
jacto PJB-20 5 Gallon Battery Powered Backpack Sprayer

The 5.2 gallon PJB-20 is both ergonomically designed and the most advanced battery powered backpack sprayer as a crop care tool. Features a removable Lithium ion battery that will provide 8 hours or more of continuous spraying and comes with a separate charger that recharges in 4 hours or less. 5 pressure settings with pressure lock, audible walking speed indicator, LED display, auto shut-down, internal hydraulic agitator and battery level indicator. 53" reinforced chemical resistant hose, field serviceable trigger valve with lock, 24 inch stainless steel wand with nozzle filter, and a four nozzle package.

Item #**1231291****Price****\$379.99**



Jacto 5-gal. Backpack Sprayer with Viton® Piston Cup

Easily spray agri-chemicals

Internally mounted brass piston pump means there are no external leaks. Produce a maximum 65 psi and take only five pumps to reach 45 psi. Feature an internal agitator for constant mixing, large fill opening, high-density polyethylene UV-resistant tank with volume markings in both gallons and liters. 26" L stainless steel wand with an adjustable cone nozzle, fan nozzle and 65" L spray hose. CD400 has a Viton piston cup. PJ16 has a Santoprene piston cup for longer life and is ideal for most pesticides.

Item #	Model	Price
224688	PJH	\$125.99
224686	CD400	\$133.99
224687	PJ16	\$133.99



SHURflo Battery-Powered 4-gal. Backpack Sprayer

Shurflo Battery-Powered Backpack Sprayer reduces fatigue by eliminating manual pumping

A breakthrough in versatility, performance and convenience. This sprayer eliminates the need for you to continually "pump" to maintain a steady spray pattern. Unique battery pack can be charged in place or easily removed without using tools. Microprocessor control allows you to select one of four pump speeds (10 to 19 psi, 18 to 26 psi, 20 to 32 psi or 26 to 37 psi), depending on nozzle selection.

Note: not for sale in (AL;GA).

Item #	HM	Price
215030	▲	\$440.00

▲ Requires special handling due to DOT regulations. Additional shipping charges will apply. Cannot be shipped by air.



solo Battery-Powered Backpack Sprayer

Silent and emission-free operation make this sprayer ideal for a variety of spraying tasks, including enclosed spaces

Silent operations and emission-free. Features a UV-resistant HDPE tank, a comfortable padded backpack frame and a drain plug. Fully charged batteries run for 5 1/2 hr on low and 3 1/2 hr on high. 20" L spray wand, 80° flat spray nozzle and 60" L hose.

Item #	Description	HM	Price
228341	4.5 Gal Sprayer	▲	\$179.99
229707	Repl Battery	▲	\$39.99

▲ Requires special handling due to DOT regulations. Additional shipping charges will apply. Cannot be shipped by air.



HUDSON Replacement Battery

Replacement Sealed Lead Acid Battery for Hudson Never Pump™ Bak-Pak® Battery-Powered Sprayer

On demand, chemical resistant mini-diaphragm pump provides a 60-psi maximum pressure. Viton seals and O-rings. 72" L spray hose and lowVage alert alarm. Includes a lid strainer, suction inlet filter and filter in the handle. 12V 10Ah lead-acid battery has a 9-hr. charge time.

NOTE: Cannot be shipped by air. Note: not for sale in (AL;GA).

Item #	HM	Description	Price
167778	▲		\$118.99
167779	▲	Repl Battery	\$131.99

▲ Requires special handling due to DOT regulations. Additional shipping charges will apply. Cannot be shipped by air.



FIMCO 12V Battery-Powered Sprayer Cart

No more pumping or carrying backpack sprayers

Large 10"-dia. hard rubber wheels offer easy portability. Rechargeable, sealed 12V 7.2Ah lead-acid battery provides 2 hours of continuous spraying. Includes 1-gpm, 35-psi diaphragm pump; 15' L Roundup Ready hose and 19" L spray wand with adjustable tip cradles on cart handle. Corrosion-resistant polyethylene tank. Steel and tubular construction. Note: not for sale in (AL;GA).

Item #	Description	HM	Price
139327	Sprayer	▲	\$314.49
215054	Repl. Battery	▲	\$49.49

▲ Requires special handling due to DOT regulations. Additional shipping charges will apply. Cannot be shipped by air.



solo Rechargeable, Two-Speed Backpack Sprayer

The Li-ion battery gives you longer runtime

Eliminates typical pumping hassles from manual sprayers and the emissions from motorized models. Perfect for a variety of spraying tasks, including working in enclosed spaces, such as greenhouses and offices buildings. Whisper-quiet operation. 11.1V Li-ion battery runs for max 5.9 hours on a single charge. Adjust between 36- or 62 psi pressure settings with a two-step toggle switch. Features a 36" L telescopic carbon fiber wand for better reach, a pressure gauge, wand holder molded to the tank, a 60" L hose and thick, padded straps with a waist belt. Battery charger and interchangeable spray nozzle system included. Note: not for sale in (AL;GA).

Item #	HM	Price
227651	▲	\$349.99

▲ Requires special handling due to DOT regulations. Additional shipping charges will apply. Cannot be shipped by air.



“This was the second mist blower that I have purchased...the Solo has more power, is quieter, easier to start and more comfortable to wear.. The blower arm also rotates and makes it much easier to spray. You can sprayer without rotating your body.”

— booneben12

solo Mist and Air Blower

A versatile landscape tool that delivers more force with less noise and vibration

More than five decades of mist-blowing performance and reliability. Durable polyethylene tank with sturdy plastic-coated tubular steel support frame. Padded back plate. High performance, anti-vibration two-cycle gas engine has a recoil starter and an electronic igniton system. Meets Category I sound levels. NOTE: Not for sale in AK, CA, HI or PR.

Note: not for sale in (AL;AR;GA).

Item #	HM	Price
198645	▲	\$714.99

▲ Requires special handling due to DOT regulations. Additional shipping charges will apply. Cannot be shipped by air.



D.B. Smith Backpack Sprayers

Redesigned to give you greater comfort with more features that you'll love

2-in-1 sprayers deliver up to 150 psi for spraying insecticides and fungicides, or use 25-psi regulator for herbicides. All feature Viton seals and o-rings, 21"L poly wand with shutoff valve, plus a 45"L spray hose. Storage clip keeps wand secure. Ambidextrous pump handle.

Item #	Description	Price
171472	Field King Pro	\$73.99
210484	Field King MAX	\$82.99
171471	Roundup	\$83.99



ProSeries Backpack Sprayers

Professional-grade sprayer that's perfect for liquid pesticide applications and loaded with features you're sure to love

This sprayer features Viton® seals, a 20"L poly spray wand and 48"L spray hose to hit all of those hard-to-reach areas. Storage clip keeps wand secure. Pump handle can be positioned on the right or left side.

NOTE: Not for use with wettable powders, as they may cause damage or wear to piston pumps.

Item #	Pump Type	Price
163123	Diaphragm	\$92.99
163122	Piston	\$93.99



solo® Handheld Sprayers

The perfect portable sprayer for applying herbicides, insecticides and other non-acidic chemicals

High-density polyethylene tanks and heavy-duty 45 psi piston pumps are ideal for herbicides, insecticides and nonacidic chemicals. Longer pump stroke and larger cylinder reduce pumping, or pressurize inflation valve with an air compressor to eliminate pumping together. Pressure relief valve. 4-1/2"-dia. tank opening. Viton seals and O-rings. 48"L spray hose, includes plastic adjustable, flat fan, hollow cone and jet stream nozzles.

Item #	Tank Capacity	Price
27986	1.5 gal.	\$49.99
27987	2.25 gal.	\$54.99



solo® Wheeled Sprayer

Spraying for pests or weeds doesn't have to be a pain in the neck when you have a Piston Pump Wheeled Sprayer

Features easy-rolling 5-1/2"-dia. Wheels mounted on a 1/2"-dia. plated-steel axle. Rugged, high density, UV-stabilized polyethylene tank, with a piston pump that generates 45-psi maximum pressure. Viton seals and O-rings, 20"L poly wand with 72"L hose. Includes flat fan, hollow cone, jet stream and adjustable nozzles. Ships fully assembled.

Item #	Price
151051	\$63.99



solo One-Hand Sprayer, 1L

Hinged, fully adjustable nozzles let you spray in any direction

1-Liter Solo One-Hand Sprayer incorporates all the easy pump, fill and clean-up characteristics found on larger Solo sprayers into one handy size. Features a fully adjustable 3-1/2" nozzle to allow spraying in all positions. Viton® seals hold up against the use of harsh chemicals and a drip/drift guard allows for controlled spot spraying. Ideal for gardening, fertilizing, weed control, cleaning and general spraying. Weighs 1.2 lb.

Item #	Tank Capacity	Price
101173	1L	\$15.99
G41803	2L	\$19.99



Trigger Spray Bottles

The uses are limitless for this heavy-duty refillable and reusable Trigger Spray Bottle

Refillable and reusable sprayers are made of high-density polyethylene for chemical resistance. The fully adjustable nozzle changes spray pattern from direct jet to a fine mist with a quick turn. 24-oz. or 32 oz. bottles. Sold as case of three.

Item #	Tank Capacity	Price
28117	24 oz.	\$10.49
28118	32 oz.	\$11.29



CHAPIN Cleaner/Degreaser Sprayer

This Chapin Cleaner/Degreaser Sprayer is built to handle the toughest chemicals so you can clean the toughest jobs

Polyethylene tank is designed for the decorative concrete and cleaning industries, so you know it's tough. Viton seals and gaskets. 4"-dia. tank opening. Built-in high pressure relief valve. Adjustable cone nozzle sprays from a coarse stream to a fine mist. Spray wand has a "lock-off" that prevents accidental discharge. Patented in-tank filter keeps debris out of the hose, shutoff and nozzle. Includes poly extension.

Item #	Tank Capacity	Price
226615	2 gal.	\$75.99
223968	3 gal.	\$84.99



CHAPIN 1.5 Gal. Professional Pest-Control Sprayers

Made for professional pest control Stainless steel tanks and a choice of two nozzle types—four position Multi Jet or poly fan. Quality sprayer has dripless trigger-grip shut off valves with all brass internal components. Features a die-cast metal pump handle, brass pump barrel, 12"L brass extension and Viton O-ring and barrel valve.

Item #	Description	Price
226617	Poly Flat Fan	\$199.99
226616	Multi Jet	\$269.99



D.B. Smith Handheld Contractor Sprayers

D.B. Smith Handheld Contractor Sprayer is a rugged unit featuring a heavy-duty tank that adds stability and a lower center of gravity

Innovative tray protects nozzle from damage during transport and storage. 45-psi piston pump. Viton seals, O-rings and 50" L hose. Pressure-relief valve. No-leak shutoff. Include foaming, watering, high- and low-volume flat fan and brass adjustable nozzles.

Item #	Tank Capacity	Price
210485	2 gal.	\$40.99
210486	3 gal.	\$49.99



CHAPIN™ CFValve™ Constant-Flow Valves

CFValve™ Constant-Flow Valves attach to your existing Chapin®, Solo®, Hudson® or Jacto® sprayer nozzle to help maintain a consistent flow rate. 14.5- and 21-psi valves help control drift and are for handheld and backpack sprayer use. 29-psi valve is designed for 12V and motorized sprayers. Includes two adapters: 11/16" to 3/8" and 3/8" to 11/16".

Item #	Maximum Pressure	Price
226294	29 psi	\$18.99
226289	14.5 psi	\$19.99
226291	21 psi	\$19.99



solo® Hand Spritzer

Perfect for quick and small spray applications

This Solo 32 oz.-Hand Spritzer is just what you need for quick and small spray applications. The simple, lightweight and easy-to-use piston-pump sprayer is perfect for when you don't need all the features or size of a larger sprayer. 0.8 lb.

Item #	Price
G68542	\$12.99



solo® Bleach Sprayer

Keep it clean and remove algae, dirt and mildew stains from decks, patios, driveways and more with this handy bleach sprayer

Perfect for cleaning and removing algae, dirt and mildew stains from decks, patios, driveways and more. Cleans and disinfects hard-finished surfaces, including toilets, tile showers and food preparation areas. Viton seal, all-poly construction. 21" L plastic wand and nozzle adjusts from a straight stream to a fine mist. Funnel top for easy fill up.

Item #	Price
224172	\$21.99



solo® Universal Replacement Spray Wands

Update your sprayer to work better than new with this heavy-duty Stainless Steel Replacement Spray Wand

Universal replacement spray wands fit any sprayer with 3/8"-dia. I.D. hose. Simply cut off the end of the hose and connect to hose barb on wand with included clamp. Include shutoff valve and a flat fan nozzle for uniform spraying. Plastic wand also includes adjustable spray nozzle.

Item #	Price
133674	\$24.99



12V Deluxe Sprayer, 25. gal

The unique design and sturdy construction of this Fimco Deluxe Sprayer makes it perfect for applying chemicals around your buildings and property

This Fimco Deluxe Sprayer features a corrosion-resistant polyethylene tank that stands up to the demands of harsh chemical use. Sprayer comes with everything you need to tackle tough jobs, including a 12V, 2.1 gpm at 60 psi maximum diaphragm pump, adjustable pressure gauge, 18" L deluxe pistol-grip spray gun with adjustable nozzle and 15' L hose. The unique tank design has large wrap horns for easy handling or convenient hose coiling. Tank has a low profile for improved stability, so it won't tip over. Full-length drain sump and full drain out capability for easy cleaning

Item #	Tank Capacity	Price
147752	15 gal.	\$183.99
147753	25 gal.	\$193.99



12V Standard Spot Sprayer, 15 gal.

The unique design and sturdy construction of this Fimco Spot Sprayer makes it perfect for handling insecticides and herbicides

12V, 1.0 gpm at 35 psi diaphragm pump, 19" spray wand with adjustable nozzle and 15' L hose. Tank has a full-length drain sump and full drain out capability. The unique tank design has large wrap horns for easy handling or convenient hose coiling. Tank has graduations in both gallons and liters for easy measuring.

Item #	Tank Capacity	Price
147750	15 gal.	\$106.99
147751	25 gal.	\$113.99



Multi-Lid Measuring Container

Conveniently stores inside the tank so you'll always have it with you

Consists of a measuring cup attached to the underside of a 5"-dia. sprayer tank lid. When the lid is installed, the 32-oz., food-grade measuring container conveniently stores inside the tank. Also has garden-hose port that secures a hose so that one person can safely and easily fill the tank. For use on all Fimco sprayer tanks with 5" dia. lids.

Item #	Price
226407	\$21.29



12V Boomless Skid Sprayer

This sprayer easily mounts onto most UTVs and creates a 30'W spray swath using only three nozzles

Boomless nozzle system provides a full 30'W spray swath using only three nozzles. Corrosion-resistant tank has molded-in gallon markers, full-length sump and a 5"-dia. fill opening. Pump includes pressure gauge. Spray gun allows access to hard to reach areas.

Item #	Tank Capacity	FT	Price
127518	40 gal.	*	\$690.99
127519	60 gal.	*	\$730.99

*Item ships by Truck due to size and weight.



GEMPLER'S 12V Spot Sprayers

Spot sprayers built for maximum durability with farm and ranch life in mind

Built using a thicker polyethylene tank and more UV inhibitor. Use with water, herbicides including glyphosate, insecticides and fungicides. EverFlo diaphragm pump works where others fail.

Features a 5"-dia. fill port with a tethered lid and a 15'L hose to extend your reach. Deluxe Sprayer (230455) features a Deluxe Spray Can with brass tip, heavy-duty lock, thick trigger and removable filter for easy cleaning.

Item #	Pump Flow (GPM)	Tank Capacity	Price
230454	1	25 gal.	\$103.99
230453	2.2	15 gal.	\$169.99
230455	2.2	25 gal.	\$174.99
230452	1	15 gal.	\$99.99



BRUSH MASTER MFG Spot Sprayers

Spot sprayers handle the rigors of petroleum products

Stand up to petroleum over the long haul. 1.6-gpm pump is diesel mix and petroleum distillate compatible. Feature durable polyethylene tanks, 15'L braided nylon hose, 5"-dia. fill lid with tether, molded-in drain with tethered cap and 12V connection cable. Spray gun adjusts from mist to stream with an impressive 16' vertical spray and 25' horizontal spray.

Item #	Tank Capacity	Price
230449	15 gal.	\$216.99
230450	25 gal.	\$236.99
230451	40 gal.	\$289.99



FIMCO 12V Mounted Skid Sprayer

This Fimco 12V Skid Sprayer is ideal for applications where you need a higher capacity spot sprayer

Knockout your large-area spraying jobs with this Fimco 40-gal. 12V Skid Sprayer. Features you'll love include a 12V 3.8 gpm at 45 psi diaphragm pump, deluxe 18"L pistol-grip spray gun with adjustable brass nozzle and 25' of hose. Corrosion-resistant tank with molded-in gallon and liter graduations and a full-length drain sump. Wrap the hose around the built in grab handles for convenience.

Item #	FT	Price
134449	*	\$401.29

*Item ships by Truck due to size and weight.



Kings Sprayers **Two-Wheel Trailer Sprayer with Boomless Nozzle**

Spray large areas quickly

Spray up to 22'W pattern without worrying about boom arms hitting obstacles like trees or fences. Features a high pressure spray hose and spray gun with quick disconnects, an adjustable pressure regulator and hydraulic jet agitation. High-flotation turf tires roll easily and wide stance keeps the sprayer stable on most terrains. Lightweight aluminum frame is chemical resistant and will never rust or need painting. 84"L x 44"W x 43"H.

NOTE: Shipped by motor freight. Charges to be determined when order is placed.

Item #	FT	Price
151231	*	\$3,603.00

*Item ships by Truck due to size and weight.



Kings Sprayers **Two-Wheel Trailer Sprayer with 12'L Boom**

Just what you need for precise turf spraying

Included boom and manual controller allow you to turn the boom on and off from your seat. Features 11 nozzles and produces a 14'W spray pattern--perfect for athletic fields, pastures and golf courses. Features a high pressure spray hose and spray gun with quick disconnects, an adjustable pressure regulator and hydraulic jet agitation. High-flotation turf tires roll easily and wide stance keeps the sprayer stable on most terrains. Lightweight aluminum frame is chemical resistant and will never rust or need painting. 84"L x 44"W x 43"H.

NOTE: Shipped by motor freight. Charges to be determined when order is placed.

Item #	FT	Price
151232	*	\$3,424.00

*Item ships by Truck due to size and weight.



12V Trailer Sprayer With Folding, Seven-Nozzle Spray Boom, 60 gal.

12V Trailer Sprayer features a 12V diaphragm pump with pressure gauge that generates spray volume of 3.8 gpm at 45 psi. The polyethylene tank has fluid volume indicators. Features a full-length drain sump and a 5"W fill lid with tether. 237 lb. Includes lead wire assembly with on/off switch to turn the pump on or off from the tow vehicle.

NOTE: Trailer for off-road use only; 10 mph maximum.

Item #	FT	Price
127523	*	\$1,043.00

*Item ships by Truck due to size and weight.



Highway-Ready Turf Unit Sprayer with 12'L Three-Section Boom, 200 gal.

Get to jobs faster by taking the highway with this full-featured, commercial-grade sprayer

Get to jobs faster with this Kings 200-gal. Highway-ready Turf Unit Sprayer with 12'L Three-Section Boom. Sprayer features a strong, lightweight aluminum frame that eliminates rust and the need for painting. Boom features 11 nozzles with 13"W spacing and an output of 0.4 gpm at 40 psi. A two diaphragm pump delivers up to 5 gpm at 275 psi. The 200-gal. poly tank includes 1"W drain with shutoff.

NOTE: Please contact your local DOT office to ensure that this sprayer is in compliance with all safety regulations in your state.

Item #	FT	Price
148061	*	\$5,699.00

*Item ships by Truck due to size and weight.



300-gal. Trailer Sprayer

Use this "Pasture Blaster" for spraying athletic fields, pastures and other large, open areas to rid them of noxious weeds

Features a PTO-driven, eight-roller pump and two boomless nozzles to provide up to a 36"W spray swath for knocking out large jobs. Trailer features 9.5" x 15", 8-ply rib implement tires, and elliptical tank for extra stability. 25'L spray hose connects to a 22"L spray wand to deliver 12 gpm at 540 rpm. 747 lb. NOTE: This item is made to order —completed units will be delivered in approximately 28 days.

NOTE: Silver Series XL pumps are compatible with glyphosate herbicides.

NOTE: Some assembly required.

NOTE: May take 5-6 weeks for delivery during spring months.

Item #	Pump Type	FT	Price
192083	8 Roller Cast Iron	*	\$2,964.00



Highway-Ready Tree and Turf Unit Sprayer, 200 gal.

Take the highway from job to job with this full-featured, commercial-grade sprayer ideal for spraying trees, ornamentals or turfs

This Kings 200-gal. Highway-ready Tree and Turf Unit Sprayer features a strong, yet lightweight aluminum frame eliminates rust and the need for painting. Also features a three-diaphragm pump that delivers up to 9.5 gpm at 580 psi and a 200-gal. poly tank with 1" dia. drain with shutoff. Weighs 700 lb. NOTE: Please contact your local DOT office to ensure that this sprayer is in compliance with all safety regulations in your state.

Item #	FT	Price
148065	*	\$6,586.00

*Item ships by Truck due to size and weight.



12V Trailer Sprayer, 25 gal.

Features a 12V diaphragm pump with pressure gauge that generates spray volume of 2.1 gpm at 60 psi. The polyethylene tank has fluid volume indicators. It also features a full-length drain sump, full drain out capability with molded-in drain port cap and tether and a 5" W fill lid with tether. Comes complete with trailer and 13"-dia. pneumatic tires for easy towing. 62 lb.

Item #	FO	Price
127521	■	\$423.99

■Oversize item: additional shipping charges will apply.



40-gal., Gas-powered Trailer Sprayer with Cast Iron Pump

Provides up to 30' of vertical throw. Corrosion-resistant polyethylene tank with molded-in gallon markers, full length sump and a 5"-dia. fill opening. Includes a five nozzle folding spray boom, which provides 100"W spray coverage. Silver Series XL pumps are compatible with glyphosate herbicides. Off-road use only; 5 mph maximum.

NOTE: Trailer for off-road use only; 5 mph maximum.

NOTE: This item is made to order. Construction takes 3 weeks—completed units will be delivered in approximately 28 days.

Item #	Pump Type	FT	Price
224490	Cast Iron	*	\$1,177.00
224491	Silver Series XL	*	\$1,506.00



3-Point Sprayers

This Fimco 3-Point, 6-Roller Pump Sprayer has a high-quality, steel frame that can handle the demands of any size job

Heavy duty, 3 point steel frames provide superior durability. Built-in braces and nylon straps add tank stability. Pressure regulator for bypass and agitation, plus manually operated valves for boom and nozzle control. Spray gun operates at 200 psi. Includes gun holder and wrap. Features breakaway booms.

NOTE: Silver Series XL pumps are compatible with glyphosate herbicides.

NOTE: Some assembly required.

NOTE: May take 5-6 weeks for delivery during spring months.

Item #	Tank Capacity	Pump Type	FT	Price
192079	55 gal.	6 Roller Cast Iron	*	\$1,312.00
217856	55 gal.	6 Roller Silver Series XL	*	\$1,756.00
192080	110 gal.	8 Roller Cast Iron	*	\$2,416.00
192081	200 gal.	8 Roller Cast Iron	*	\$2,592.00
217857	110 gal.	8 Roller Silver Series XL	*	\$2,901.00
192082	300 gal.	8 Roller Cast Iron	*	\$2,954.00
217858	200 gal.	8 Roller Silver Series XL	*	\$3,007.00
217859	300 gal.	8 Roller Silver Series XL	*	\$3,445.00

*Item ships by Truck due to size and weight.



50-gal. Three-Point Boomless Sprayer

Quickly and efficiently spray large areas

This Kings 50-gal. Three-point Sprayer w/Boomless Nozzle eliminates the hassles of catching a boom on trees, fences and other obstacles, making it just right for spraying lawns, golf courses, athletic fields and pastures. It has a high-pressure spray gun with quick disconnects, an adjustable pressure regulator and hydraulic jet agitation, and a quick-disconnect 540-rpm pump adapter.

NOTE: Silver Series XL® pumps are compatible with glyphosate herbicides. Shipped by motor freight. Charges to be determined when order is placed.

Item #	FT	Price
151367	*	\$2,039.00
217841	*	\$2,367.00

*Item ships by Truck due to size and weight.



Three-Point Hitch Sprayer with 12'L Spray Boom

Quickly and efficiently spray large areas

Spray large areas with less-frequent stops for tank filling. The 12'L spray boom will spray an adjustable 14' pattern and features breakaway arms. High-pressure spray hose and spray gun with quick disconnects are included. Features an adjustable pressure regulator and hydraulic jet agitation. Lightweight aluminum frame makes it easy for one person to hook it up and is chemical resistant so it will never rust or need painting. NOTE: Silver Series XL® pumps are compatible with glyphosate herbicides. Shipped by motor freight. Charges to be determined when order is placed.

Item #	Pump Type	FT	Price
151368	8 Roller Cast Iron	*	\$2,461.00
217842	8 Roller Silver Series XL	*	\$2,985.00

*Item ships by Truck due to size and weight.



3-Point Hitch Sprayer with 50'L Hose

Ideal sprayer for large areas where a boom just isn't practical. Features a high-pressure spray hose and spray gun with quick disconnects to reduce frequent stops. An adjustable pressure regulator and hydraulic jet agitation. Lightweight aluminum frame makes it easy for one person to hook it up and is chemical resistant so it will never rust or need painting. Sprays up to 30'. 52"L x 48"W x 50"H. NOTE: Silver Series XL® pumps are compatible with glyphosate herbicides.

Item #	Pump Type	FT	Price
198502	8 Roller Cast Iron	*	\$2,045.00
217844	8 Roller Silver Series XL	*	\$2,517.00

*Item ships by Truck due to size and weight.



Skid-Mounted Pressure Washing Unit without Hose Reel

Clean your equipment, siding or vehicle fleets without worrying about a nearby water source

Simply fill the tank at any convenient location and you're ready to wash. A 12"-dia. hose reel (Item # 147667), sold separately online is available to increase hose length to 100'L. Optional hose reel weighs 50 lb. Unit includes: 50'L 3/8" 3,000-psi High-pressure hose with quick disconnects
30"L Spray wand with four spray nozzles, soap applicator nozzle and chemical injector.

NOTE: Unit shown with optional hose reel.
NOTE: Product comes with one bracket to wrap hose around (not pictured).
Note: not for sale in (AL,GA).

Item #	FT	HM	Price
147631	*	▲	\$2,058.00

*Item ships by Truck due to size and weight.
▲ Requires special handling due to DOT regulations. Additional shipping charges will apply. Cannot be shipped by air.



Universal Skid Sprayer, 100 gal.

This 100-Gal. Skid Sprayer is considered a universal unit because the compact size fits in pickup beds and most UTVs

Compact size allows for use in truck beds or most utility vehicles. High-output pump allows high pressure distance spraying or high volume spraying for turf or drenching. Features a high pressure spray gun with quick disconnects. Adjustable pressure regulator and adjustable hydraulic jet agitation are included. Lightweight aluminum frame is chemical resistant and will never rust or need painting. 55"L x 38"W x 34"H.

Item #	FT	Price
151141	*	\$3,999.00

*Item ships by Truck due to size and weight.



Kings UTV Skid Sprayer, 50 gal.

The compact size makes it the perfect choice for most utility vehicles, the features make it the perfect choice for the job

Features a high-pressure spray hose and spray gun with quick disconnects. Pump holds up well to most herbicides and fertilizers. Adjustable pressure regulator and adjustable hydraulic jet agitation are included. Lightweight aluminum frame is chemical resistant and will never rust of need painting. 36"L x 38"W x 26"H. NOTE: a hose reel cannot be mounted on this model.

NOTE: A hose reel cannot be mounted on this model.

Item #	FT	Price
151138	*	\$2,364.00



Skid Sprayer

This Fimco Skid Sprayer features a heavy-duty, 200-gal. poly tank that can take on your largest spraying jobs

The Fimco Skid Sprayer is rugged and large enough to handle most large-scale spraying project - including large lawn jobs, landscaping and spraying ice melters. The space-saving elliptical tank has a lower center of gravity compared to regular tanks, providing increased stability when towed on a trailer.

NOTE: Silver Series XL® pumps are compatible with glyphosate herbicides.

NOTE: Some assembly required.

NOTE: May take 5-6 weeks for delivery during spring months.

Item #	Tank Capacity	FT
192076	200 gal.	*

*Item ships by Truck due to size and weight.



3-Point Sprayer

Features a 40-gal. corrosion-resistant polyethylene tank. Features a 2.1-gpm, 12V pump with adjustable pressure gauge that generates up to 60 psi when used with a No. 2 spray tip. Includes 25'L hose and 18"L deluxe pistol-grip spray gun. Maximum throw 35' horizontal and 25' vertical. Sprayer weighs 80 lb.

Item #	FT	Price
171563	*	\$390.59

*Item ships by Truck due to size and weight.



High Volume Turf and Tree Sprayer with Boomless Nozzle

This 50-gal. Turf and Tree Sprayer with Boomless Nozzle is designed for high-volume, high-pressure spraying jobs

The Kings 50-gal. High-Volume Turf & Tree Sprayer features a boomless nozzle that sprays a 22'W pattern with a spray volume of 2.5 gpm at 40 psi. Comes with a 150'L x 3/8" I.D. high-pressure hose and a high-pressure spray gun with quick disconnects for hard-to-reach targets. Adjustable pressure regulator and adjustable hydraulic agitation are included. Weighs 230 lb.

Item #	FT	Price
151140	*	\$4,587.00

*Item ships by Truck due to size and weight.



25-gal., 12V ATV Sprayer with Quick-Release Dripless Boom

Easily spray glyphosate herbicide from your ATV

The Fimco 25-gal., 12V ATV Sprayer with Quick-release Dripless Boom lets you easily spray glyphosate herbicide from your ATV. It has a poly spray tank and a 96"L lead wire with quick coupler, in-line switch and deluxe battery clips.

Item #	FT	Price
226137	*	\$464.99

*Item ships by Truck due to size and weight.



3-Point Sprayer

Knockout large spraying jobs with your tractor and this Fimco 3-Point Sprayer

Attach this Fimco 3-Point Sprayer directly to your tractor's Category 1 three-point hitch and go. No need to pull a trailer or haul a skid around. Six-roller cast iron pump (sold separately as Item No. 134451) comes with PTO coupler and torque arm to support hoses and pump thrust. Weighs 180 lb. Boom has a manual lever valve control. Sprayer has a 55-gal. corrosion-resistant polyethylene tank. NOTE: Shipped by motor freight. Charges to be determined when order is placed.

Item #	FT	Price
134451		\$227.89
134450	*	\$774.39

*Item ships by Truck due to size and weight.



Endureplus Firefighting Skid Sprayers

This fire fighting sprayer fits most full-size pickup beds to take fire-fighting to out-of-the-way places

Great for reaching those out of the way places. These sprayers help prevent fires from spreading or mop up after a fire has occurred to prevent flare ups. Includes sprayer, a Banjo fire nozzle, volume markings and a sump for easy removal of spray material. Sprayers include a 20'L bottom fill hose kit with quick disconnects and foot strainer, so you can quickly refill the tank in remote areas from any water source. 250-400 gallon tanks available. 120 gpm at 100 psi. Manual hose reel.

Item #	Tank Capacity	FT	Price
215290	250 gal.	*	\$3,810.00
215291	300 gal.	*	\$4,116.40
215292	400 gal.	*	\$4,221.98

*Item ships by Truck due to size and weight.



UTV Sprayer with 7-Nozzle Booms

Increase your spray coverage

This Fimco UTV Sprayer with 7-Nozzle Boom makes it easy to increase your spray coverage. Can be used with closed or open UTV tailgates. Includes 25'L hose and multi-lid. UTV Hose Reel sold separately ().

NOTE: This item is made to order.

Construction takes 3 weeks—completed units will be delivered in approximately 28 days.

Item #	FT	FO	Price
227702			\$247.19
227667	*		\$661.99
227666		■	\$670.99
227669	*		\$765.00
227668	*		\$788.00

*Item ships by Truck due to size and weight.

■ Oversize item: additional shipping charges will apply.



DAVIS Chemical Edging Tool

Treats only the areas you want so that neighboring plants, sod and trees aren't damaged. Roller stays completely saturated with chemical for a uniform application. 1-gal. capacity. 52"L.

Item #	Width	Price
D405	4"	\$179.99
D605	6"	\$179.99
162446	12"	\$189.99
162447	18"	\$189.99



Sideswipe® Spot Herbicide Applicator

This inexpensive and durable Sideswipe Herbicide Applicator saves you hours of back-breaking effort to treat dandelions, crabgrass and other weeds around walkways, fruit and vegetable plantings, hedge rows or anywhere precision weed treatment is desired. 1-qt. capacity covers 1800 sq ft. without refill. Includes shield to protect desirable plants.

Item #	Description	FO	Price
RSS209	Repl. Applicator		\$20.99
RSS101	Applicator	■	\$52.99
RSS105	Repl. Shield		\$7.99

■ Oversize item: additional shipping charges will apply.



DRAMM® Herbi® Herbicide Sprayer

Just what you need for any landscaping situation where chemical drift would damage valuable plants and crops

Produces large, even 200 micron particles that spray out as a fine mist in a 4'W umbrella pattern. One 2.5L bottle spray solution covers up to 20,000 sq. ft. Uses 40 times less water than a traditional backpack sprayer. Sprayer is battery powered to eliminate manual pumping, and operates 40 to 50 hr. on (4) D cell batteries (not included). Includes three spray nozzles with a flow rate range of 60 to 150mL per minute.

Item #	Price
H1350	\$324.99



hudson Trombone Sprayer

This hand-operated pump shoots a jet stream up to 25' so you can spray treetops or wash and rinse walls/ceilings with ease

Spray treetops or wash and rinse walls/ceilings in a fraction of the time. Shoots a jet stream up to 25'. Spray adjusts from a jet stream to a fine mist. Barrel and nozzle are heavy-duty, nickel-plated brass. 5'L hose draws from a bucket or drum (not included). Pistol grip handle. Hand operated and portable.

Item #	Price
--------	-------



Earth Way Spray-Pro Ground-Driven Sprayer

Easily spread pesticides, fertilizers and ice melters

Battery-, gas- and oil-free. Self priming, gear driven pump is operated by axle and distributes an even spray pattern. 24 to 60" spray width. Three spray nozzles allow selection from fine, medium or coarse patterns. Stud-type, 13"-dia. pneumatic tires.

Item #	Price
163155	\$456.99



hudson Professional High-Pressure Spray Gun

Features drip free shut off. Works with pressures from 5 to 1,000 psi. 3/4"-dia. garden hose thread with removable 1/2"-dia. insert. Comes with a 3- to 8-gpm nozzle.

Item #	Description	Price
139452	0.3-1 gpm Nozzle	\$18.89
139453	1-3 gpm Nozzle	\$18.89
139454	2-5 gpm Nozzle	\$18.89
139455	3-8 gpm Nozzle	\$18.89
139456	10-19 gpm Nozzle	\$18.89
200095	JD9-C Handgun	\$205.49
134454		\$26.29



TeeJet GunJet® AA43 Spray Gun, Low Pressure

The responsive, no-leak design of the GunJet AA43 will make this your "go-to" spray gun

Heavy-duty chemical-resistant, aluminum spray gun. 1/2" NPT female inlet.

Item #	Price
171410	\$114.29



FIMCO Economy Spray Gun

This Fimco spray gun has everything you want in a cost-effective option

Features a 3/8"-dia. hose shank connection and operates on pressures up to 100 psi. The trigger locks for continuous spraying, plus the spray tip adjusts from a straight stream to a cone spray. Measures 29"L overall with 19"L metal extension.

Item #	Price
134453	\$10.59



Udor® High-Pressure, Turbo Spray Gun

The Udor Turbo Spray Gun is extremely versatile - just what you want for turf, greenhouse, nursery and general plant spraying

Udor spray guns combine quality components to make lightweight, rugged spray guns that work great for tree and shrub spraying, pest control and cleaning equipment. Spray pattern is adjustable from straight stream to cone mist. The Turbo Spray Gun features an 8"L barrel and comes with a 2.3mm tip. Delivers up to 15 gpm at 725 psi.

NOTE: All Udor spray guns feature metric inlets. Adapters are needed for use with NPT fittings (Item No. 171451, 171452 and 171453).

Item #	Price
171454	\$181.29



hudson Green Garde® GES-505 Spray Gun

Easily spray all your trees and shrubs

Sprays up to 800 psi from a fine mist to a long-distance pencil stream, with a drip-free shutoff. Medium tip with 2-5-gpm output. Features 1/2" NPT female fitting. NOTE: Root feeders cannot be attached to this item. It does not have a 3/4" GHT fitting.

Item #	Price
224517	\$99.99



TeeJet GunJet® AA30L Spray Gun

Comes with or without an optional 18"L or 24"L extension with 1/4" NPT female inlet. Molded nylon body and trigger. Flow rates up to 5 gpm at 250 psi.

NOTE: Spray tip not included. Brass adjustable ConeJet® 5500-X8 tip is sold separately, Item No. .

Item #	Price
200402	\$17.39
171412	\$50.99



TeeJet Lawn Spray Gun

Select from three different tips for best results

Maximum operating pressure is 200 psi. 3/4" female NPT thread.

Item #	Nozzle Tip Number	Price
160355	4	\$81.59



Aluminum Telescopic Wand Handgun

Spray hard-to-reach places without using a ladder or platform

Telescopes and adjusts in length from 50"L up to 84"L. Includes a trigger lock for continuous spraying and operates for working pressures up to 100 psi. 3/8" inlet.

Item #	FO	Price
145850	■	\$55.39

■ Oversize item: additional shipping charges will apply.

TeeJet TriggerJet® Spray Gun - 1/4" Hose Barb

An economical spray gun for your low-pressure spray jobs

21"L aluminum extension wand. Trigger lock allows gun to remain in an open position for continuous flow. Polypropylene strainer located inside handle prevents clogging. Includes an X18 spray tip.

Item #	Description	Price
171415	1/4" Hose Barb	\$17.39
171416	3/8" Hose Barb	\$17.39



On Demand 12V Pumps

This heavy-duty, on-demand sprayer pump is chemical-resistant, making it perfect for pesticide spraying and transfer applications

Operate only when liquid flow is required. An internal fan cools operation and an inline fuse provides protection. Chemical-resistant Santoprene diaphragms and viton valves accommodate pesticide pumping in agriculture spraying and transfer applications. Available in three flow rates. 1.0-gpm pump includes 3/8" hose barb fittings. 2.1-gpm pump includes 1/2" hose barb (inlet) and 1/2" MNPT (outlet) fittings. 96° L lead wire assembly (sold separately) has a wired on/off switch.

NOTE: The manufacturer's warranty is voided if bleach in any concentration is run through pump.

Item #	Capacity GPM	Price
147768	4.5 gpm	\$129.99
147766	1.0 gpm	\$69.99
147767	2.1 gpm	\$97.99



12V Diaphragm Pumps

A perfect replacement pump for small- to medium-sized sprayers or general purpose fluid transfer

Features a sealed motor, heavy 14-ga. 2-pin lead wires, Viton® valves and Santoprene™ diaphragm. Demand-Style Pump: Better suited for longer duty cycles. Bypass-Style Pump Better for applications that would cause frequent starting and stopping of a demand-style pump.

Item #	Capacity GPM	Port	Style	Price
224027	3	1/2" FNPT	Demand	\$119.99
224028	3	1/2" FNPT	Bypass	\$119.99
224030	4	1/2" FNPT	Bypass	\$139.99
224029	4	1/2" FNPT	Demand	\$139.99
224031	5.3	1/2" FNPT	Demand	\$159.99
224032	5.3	1/2" FNPT	Bypass	\$159.99
224034	7	1/2" FNPT	Bypass	\$299.99
224033	7	1/2" FNPT	Demand	\$299.99
224023	1	3/8" FNPT	Demand	\$66.99
224024	1	3/8" FNPT	Bypass	\$66.99
224025	2	3/8" FNPT	Demand	\$72.99
224026	2	3/8" FNPT	Bypass	\$72.99



Hypro® Pump, 4-roller SilverCast

Rotary action requires no check valves and a lower starting torque than other pumps. Use for pesticides and liquid fertilizers. Use cast iron for general spraying and the SilverCast models for liquid fertilizers, soil fumigants, glyphosates and insecticides containing phosphates. Designed for general spraying.

Item #	Maximum Pressure	Shaft Size	Price
162403	150 psi	5/8" Solid	\$151.99
162405	300 psi	5/8" Solid	\$158.09
215015	300 psi	5/16" Solid	\$214.19
162404	150 psi	5/8" Solid	\$407.99
162406	300 psi	5/8" Solid	\$458.99
215016	300 psi	5/16" Solid	\$550.79

Keep your 12V Fimco sprayer pump operating efficiently

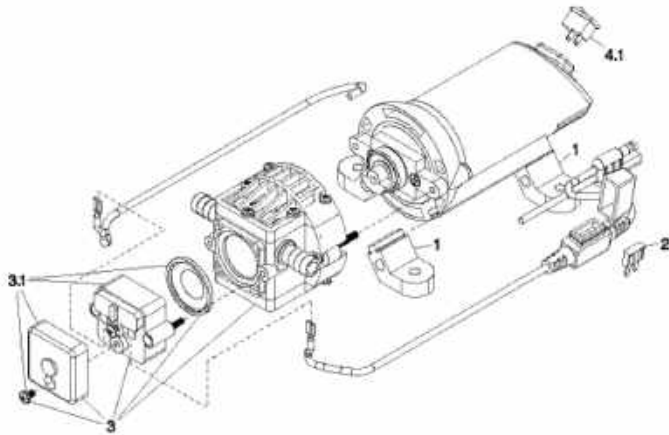

1.0-GPM On-Demand Sprayer Pump Replacement Parts

Item #	Description	No.	Price
210530	Pump Foot (Pkg. of 4)	1	\$6.19
210531	5A Mini Fuse	2	\$4.39
210532	Pump Assembly with Pressure Switch	3	\$38.79
210533	Pressure Switch with Diaphragm	3.1	\$25.49
210534	Rocker Switch	4.1	\$8.19

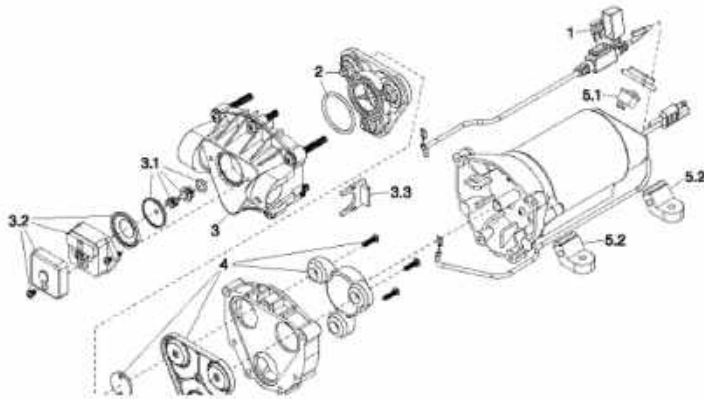

2.1-GPM On-Demand Sprayer Pump Replacement Parts

Item #	Description	No.	Price
210535	7.5A Mini Fuse	1	\$4.09
210536	Check Valve Kit (Inc. O-ring)	2	\$23.49
210537	Upper Housing Assembly	3	\$48.99
210538	Plunger Kit	3.1	\$9.69
210539	Pressure Switch Assembly	3.2	\$25.49
210541	Port Fitting Clips (Pkg. of 2)	3.3	\$4.09
213033	Diaphragm/Cam/Bearing Kit	4	\$20.39
210534	Rocker Switch	5.1	\$8.19
210530	Pump Foot (Pkg. of 4)	5.2	\$6.19

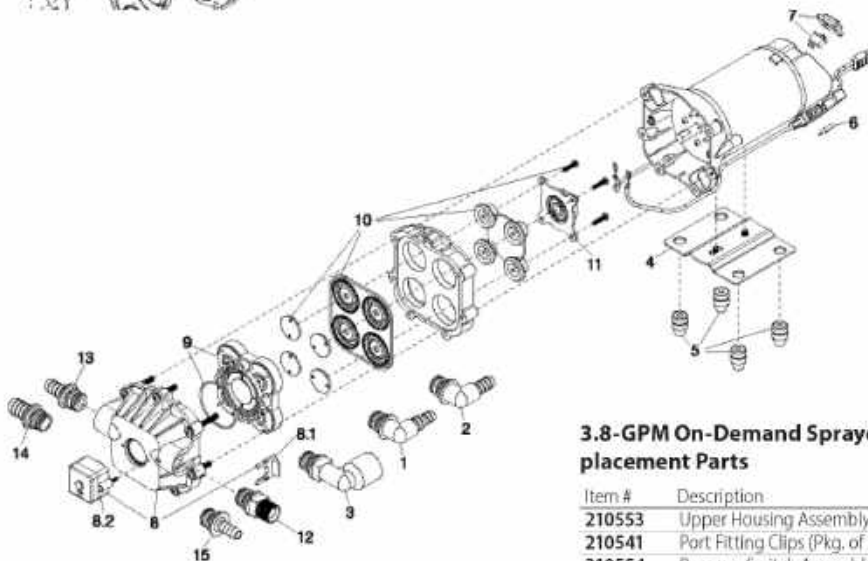

3.8-GPM On-Demand Sprayer Pump Replacement Parts

Item #	Description	No.	Price
147880	90° Port Elbow Fitting, 3/8" Hose Barb	1	\$10.19
167661	90° Port Elbow, 1/2" Hose Barb	2	\$4.09
167638	Port Kit Elbow, 1/2" FNPT	3	\$4.89
210550	Base Plate (Quad Pump)	4	\$10.69
210551	Grommets (Pkg. of 4)	5	\$3.59
210552	15A Fuse	6	\$4.09
210534	Rocker Switch	7	\$8.19

Item #	Description	No.	Price
210553	Upper Housing Assembly	8	\$42.89
210541	Port Fitting Clips (Pkg. of 2)	8.1	\$4.09
210554	Pressure Switch Assembly	8.2	\$25.49
210555	Check Valve Kit (Inc. O-ring & Ferrules)	9	\$28.59
210556	Diaphragm Kit (Inc. Pistons & 4 Screws)	10	\$23.49
210557	Cam/Bearing Kit w/ Set Screw	11	\$14.29
147839*	Port Kit Fitting, 1/2" MNPT	12	\$4.09
147840*	Port Kit Fitting, 1/2" Hose Barb	13	\$4.09
167644	Port Kit Fitting, 5/8" Hose Barb	14	\$4.09
167640	Port Kit Fitting, 3/8" Hose Barb	15	\$4.09

*Only these fittings are included with the pump. All others are optional.



FIMCO Wet Boom

Adjustable nozzles provide spraying patterns to fit your needs

Stainless steel, 43"W boom quickly sprays large areas like pastures, fence rows and sports fields. Approximate 30'W coverage area with three adjustable nozzles to spray left, right, center of all three. Center nozzle with 1/2" hose barb connects a supply hose (not included from your sprayer pump). Optional universal mounting brackets attach the wet boom to most ATV racks.

Item #	Description	Price
147815	Hex Lock Nut for U-bolt	\$0.49
147818	U-bolt for Mounting Boom	\$1.19
147820	Boom Mounting Bracket	\$11.99



FIMCO 12V On/Off Remote Control

Control from operator's seat without wires. Easy to install remote control module connects between the battery and pump or motor. Convenient keychain with clip to turn your equipment on and off. Wireless remote range 250'.

Item #	Price
171443	\$27.29



FIMCO Sprayer Hoses

Replace your sprayer hose or extend it with this EPDM (ethylene propylene diene monomer), Roundup®-ready rubber hose. Durable two spiral braid, lasso-resistant hose can be used for working pressures up to 250 psi.

Item #	Description	FO	Price
215047	1/2" ID, 100' L		\$129.39
215048	1/2" ID, 100' L		\$132.59
134456	3/8" ID, 15' L		\$15.29
215049	3/4" ID, 100' L		\$208.99
215051	1-1/4" ID, 50' L		\$234.59
134457	3/8" ID, 25' L		\$26.49
215050	1" ID, 100' L		\$270.29
215052	1-1/2" ID, 50'L	■	\$285.59
134458	3/8" ID, 35' L		\$34.69
134459	3/8" ID, 50' L		\$48.99



FIMCO Sprayer Tanks and Replacement Parts

Spray hose wraps around side handles for easy storage

Low-profile corrosion-resistant polyethylene tanks include a full length sump for easy draining. Convenient side handles are also used for wrapping spray hose. Feature gallon and liter fluid-level indicators.

Item #	Description	FT	Price
167662	60 gal. Elliptical Tank	*	\$144.99
134463	Drain Plug w Tether		\$4.69
151252	15-gal Tank		\$58.19
151253	25 gal. Tank		\$71.39

*Item ships by Truck due to size and weight.



Tank Neutralizer and Cleaner, 2-lb. Container

This patented powder was developed by the federal government to neutralize chemicals and safely clean pesticides and residue from spray tanks

This Fimco Tank Neutralizer and Cleaner is non-corrosive, works in hard water and is effective at all temperatures. Use 8 oz. of tank cleaner for every 25 gal. of water. 2 lb. of powder makes up to 100 gal. of cleaning solution.



Item #	Price
151134	\$20.39



GEMPLER'S Spray Tank Cleaner

Effectively cleans your spray tank and spray system, plus eliminates pesticide carryover

Effectively cleans your spray tank and spray system and eliminates pesticide carryover. Counteracts the harmful effects of minerals commonly found in hard water conditions that may clog your spray system. Completely soluble. Capable of cleaning diesel/herbicide mixes.

Item #	Price
PL10	\$22.99



Drift Retardant

Drift Retardant is ideal for agricultural and turf applications to reduce spray drift that might affect other crops or the neighbors

Water-soluble product stays in suspension and increases droplet size to 200-400 microns. Droplets are heavier, more stable and resist movement from the target zone. Larger droplet size retards evaporation up to 30% in hot weather. Use 1-2 oz. per 100 gal. Start with a lower dosage and increase as needed.

NOTE: Cannot be sold or shipped to California or Canada.

Item #	Price
PL32	\$26.99



GEMPLER'S Defoamer, 1 gal.

Gempler's Defoamer prevents and suppresses foam in pesticide and fertilizer spray tanks

Add 0.5 oz. of defoamer per 100 gal. of spray mixture before agitation or mixing the pesticide, fertilizer or surfactants into the solutions. More defoamer may be needed to prevent foam buildup in urea solutions. Does not affect the performance of fertilizers and pesticides.

Item #	Price
G45000	\$23.99



Blue Liquid Spray Colorant, 1 gal.

Eliminate wasteful overspraying and save yourself time and money with this Blue Spray Colorant

Signal Blue Liquid Spray Colorant temporarily turns spray solution blue so you can see exactly where you've sprayed. Colorant measures: 1/2 oz. for 1 gal, 1 qt. for 75 to 100 gal., and 1 gal. for 300 to 400 gal.

Item #	Description	Price
748	1 Gal.	\$54.99
G44600	Cs. of 12 Solupaks	\$88.99



Replacement Manifolds

Replacement Manifold Assembly for Fimco 15- and 25-gal. Deluxe Spot Sprayers

Fimco Manifold Assembly include valves to regulate flow to the boom, spray gun and bypass. For use with Fimco Deluxe Spot Sprayers (Item # 147752 and 147753).

Item #	Price
167632	\$20.39
167648	\$21.39



System with Tank Rinse

High-quality 15-gal. inductor system quickly mixes chemicals and delivers them to your sprayer tank without ever touching your pump.

Item #	FO	Price
162402	■	\$763.99

■ Oversize item: additional shipping charges will apply.



Baffle Balls

Keep liquid loads stable during transport

Keep liquid loads stable when moving them from location to location. Simple to use, just snap together and drop in the tank.

Item #	Diameter	FO	Price
218018	14"	■	\$282.00
218017	7-1/2"		\$615.00

■ Oversize item: additional shipping charges will apply.



4-Bolt Poly Ball Valves

Precision-molded polypropylene is reinforced with fiberglass for added strength. Features FKM (Viton®-type) seals for excellent chemical resistance and stainless steel bolts for long life.

Item #	Pipe Size	Price
222108	1-1/4"	\$29.24
222106	3/4"	\$29.99
222107	1"	\$34.99
222109	1-1/2"	\$44.99
222111	2"	\$44.99



Enduron Foam Marker Concentrate

Clearly mark where you've sprayed

Creates thick, long-lasting white foam to clearly mark the area you've sprayed so you can avoid expensive overlaps. Use at a 100:1 dilution rate (12- 13 oz. concentrate per 10-gal. water). 1-gal. container.

Item #	Price
151266	\$46.99



A



B



C



D



E



F



G



H



Polypropylene Cam Lever Couplings

Complete line of couplings from 3/4"–4"

These precision-molded polypropylene-cam lever couplings are rugged and strong. Feature PVC gaskets and stainless steel pins, arms and pins.

Item #	Description	Pk.	Style	Price
222140	1/2" Male Adapter x 3/4" Female Thread	75 pk	A	\$3.99
222158	3/4" Female Coupler x 1/2" Male Thread	75 pk	B	\$9.39
222186	3/4" Female Coupler x 1/2" Hose Shank	75 pk	C	\$8.39
222201	3/4" Female Coupler x 1/2" Female Thread	75 pk	D	\$6.39
222209	1/4" Male Adapter x 1/2" Hose Shank	125 pk	E	\$4.19
222217	3/4" Male Adapter x 1/2" Male Thread	125 pk	F	\$4.19
223811	1/2" & 3/4" Plug for Female Coupler	25 pk	G	\$4.19
223817	1/2" & 3/4" Cap for Male Adapter	125 pk	H	\$6.39
222141	3/4" Male Adapter x 1/4" Female Thread	75 pk	A	\$3.39
222169	1/4" Female Coupler x 3/4" Male Thread	75 pk	B	\$8.39
222191	3/4" Female Coupler x 3/4" Hose Shank	125 pk	C	\$8.39
222202	1/4" Female Coupler x 3/4" Female Thread	125 pk	D	\$8.39
222210	1/4" Male Adapter x 3/4" Hose Shank	125 pk	E	\$4.19
223804	1/4" Male Adapter x 1/4" Male Thread	125 pk	F	\$4.19
223811	1/2" & 3/4" Plug for Female Coupler	25 pk	G	\$4.19
223817	1/2" & 3/4" Cap for Male Adapter	125 pk	H	\$8.39
222142	1" Male Adapter x 1" Female Thread	125 pk	A	\$3.99
222180	1" Female Coupler x 1" Male Thread	125 pk	B	\$9.99
222192	1" Female Coupler x 1" Hose Shank	125 pk	C	\$9.99
222203	1" Female Coupler x 1" Female Thread	125 pk	D	\$9.99
222211	1" Male Adapter x 1" Hose Shank	125 pk	E	\$4.29
223805	1" Male Adapter x 1" Male Thread	125 pk	F	\$4.29
223812	1" Plug for Female Coupler	125 pk	G	\$4.09
223818	1" Cap for Male Adapter	125 pk	H	\$9.99
222143	1" Male Adapter x 1-1/4" Female Thread	125 pk	A	\$2.99
222193	1" Female Coupler x 1-1/4" Hose Shank	125 pk	C	\$9.99
222212	1" Male Adapter x 1-1/4" Hose Shank	125 pk	E	\$4.29
223806	1" Male Adapter x 1-1/4" Male Thread	125 pk	F	\$4.29
223812	1" Plug for Female Coupler	125 pk	G	\$4.09
223818	1" Cap for Male Adapter	125 pk	H	\$9.99
222144	1-1/2" Male Adapter x 1-1/2" Female Thread	125 pk	A	\$4.19
222182	1-1/2" Female Coupler x 1-1/2" Male Thread	125 pk	B	\$10.89
222194	1-1/2" Female Coupler x 1-1/2" Hose Shank	125 pk	C	\$10.89
222205	1-1/2" Female Coupler x 1-1/2" Female Thread	125 pk	D	\$10.89
222213	1-1/2" Male Adapter x 1-1/2" Hose Shank	125 pk	E	\$4.29
223807	1-1/2" Male Adapter x 1-1/2" Male Thread	125 pk	F	\$4.29
223813	1-1/2" Plug for Female Coupler	25 pk	G	\$4.69
223819	1-1/2" Cap for Male Adapter	125 pk	H	\$10.89
222145	2" Male Adapter x 2" Female Thread	125 pk	A	\$4.79
222183	2" Female Coupler x 2" Male Thread	125 pk	B	\$13.29
222195	2" Female Coupler x 2" Hose Shank	125 pk	C	\$13.29
222206	2" Female Coupler x 2" Female Thread	125 pk	D	\$13.29
222214	2" Male Adapter x 2" Hose Shank	125 pk	E	\$5.99
223808	2" Male Adapter x 2" Male Thread	125 pk	F	\$5.99
223814	2" Plug for Female Coupler	25 pk	G	\$5.99
223820	2" Cap for Male Adapter	125 pk	H	\$13.29
222146	3" Male Adapter x 3" Female Thread	75 pk	A	\$9.49
222184	3" Female Coupler x 3" Male Thread	75 pk	B	\$21.89
222196	3" Female Coupler x 3" Hose Shank	75 pk	C	\$21.89
222207	3" Female Coupler x 3" Female Thread	75 pk	D	\$21.89
222215	3" Male Adapter x 3" Hose Shank	75 pk	E	\$14.59
223809	3" Male Adapter x 3" Male Thread	75 pk	F	\$14.59
223815	3" Plug for Female Coupler	25 pk	G	\$11.49
223821	3" Cap for Male Adapter	75 pk	H	\$21.89
222157	4" Male Adapter x 4" Female Thread	75 pk	A	\$18.99
222208	4" Female Coupler x 4" Female Thread	75 pk	D	\$34.99
222216	4" Male Adapter x 4" Hose Shank	75 pk	E	\$13.99
223810	4" Male Adapter x 4" Male Thread	75 pk	F	\$13.99
223816	4" Plug for Female Coupler	25 pk	G	\$11.99
223822	4" Cap for Male Adapter	75 pk	H	\$31.99



3/4" Quick-Connect Garden Hose System

No need to tighten with a pliers for leak prevention

Features a cam lever system for quick connection of hoses to quickly move from wand/sprinkler, sprayers or other hoses. Fits standard 3/4" GHT Quick-Connect systems and provides construction.

Item #	Description	Price
222027	A 3/4" Adapter 2 3/4" GHT Female	\$4.09
222028	B 3/4" Coupler 3/4" GHT Male	\$8.89
222029	C 3/4" Coupler 3/4" GHT Female	\$8.89
222030	D 3/4" Adapter x 3/4" GHT Male	\$4.09



80° Extended-Range Flat Spray Nozzle

80° Extended-Range Flat Spray Nozzle features three pressure options that are excellent for contact pesticides

This TeeJet Extended-Range Flat Spray Nozzle gives you three pressure options that let you control drop size for customized spraying. MEDIUM PRESSURES (20-30 psi): Produce medium-sized droplets for good surface coverage and less drift. HIGHER PRESSURES (30-60 psi): Produce smaller droplets for better coverage. LOWER PRESSURES (15-20 psi): Produce larger spray droplets and reduce drift while still providing uniform coverage along the boom. Can be used with systemic pesticides. Specify Color: Blue, Brown, Red, White or Yellow.

Item #	Price
G48800	\$7.69



AIC Flat Spray Tips

Uniform coverage and less drift make these AIC Flat Spray Tips one of your best investments

This TeeJet AIC Flat Spray Tip produces a 110° flat spray pattern for uniform coverage in broadcast spraying applications. Tip features an AI nozzle molded into Quick cap for automatic spray alignment. Ideal for applying pesticides to ag crops or turfgrass. A Venturi air aspirator produces large, air-filled droplets: resulting in excellent drift management at medium to high pressures (30 to 115 psi). Stainless steel tip features VisiFlo® color-coding for quick identification.

Item #	Price
171405	\$12.29



Air Induction Nozzles -- XR Flat Spray Tip

Provide excellent drift resistance

TeeJet AIXR air induction XR flat spray tips produce excellent drift resistance without compromising spray coverage. Large, air-filled drops stay on target and cover the entire plant. 110° tips have operating range of 15 to 90 psi at 20" spacing. Ideal for pre-emerge surface applied herbicides and post-emerge systemics.

Item #	Price
160320	\$8.19



Turbo TeeJet® Nozzle

Unequalled drift control at 15–90 psi with Turbo TeeJet Nozzle. TeeJet is the world leader in spray components for agriculture, turf and ornamental, horticulture and right-of-way industries. Now you have the convenience of ordering them from Gempler's. Each TeeJet nozzle tip is made of stainless steel with VisiFlo® color-coding. The TeeJet nozzles are excellent for soil incorporated, premerge, post-emerge and systemic herbicides and systemic fungicides and insecticides. The large round free passages minimize clogging. The TeeJet nozzles are excellent for use with automatic sprayer controls.

Item #	Price
G41805	\$8.19



Air Induction Nozzle

TeeJet is the world leader in spray components for agriculture, turf and ornamental, horticulture and right-of-way industries. Now you have the convenience of ordering them from Gempler's. Each tip is made of stainless steel with VisiFlo® color-coding. Produce larger droplets for less drift. Depending on the chemical, the AI produces large, air-filled drops through the use of a venturi air-aspirator. Provide uniform coverage for broadcast spraying. 30-115 psi spray pressure and 20" nozzle spacing.

Item #	Price
G41002	\$14.29
G41002	\$15.29



TurfJet® Wide-angle Flat Fan Spray Nozzles

The 140° to 150° spray angle makes the TurfJet® wide-angle flat fan spray nozzles ideal for systemic applications of herbicides, fungicides and insecticides. 25- to 75-psi spray pressure with spacing from 20" to 40". Optional 90 nylon fitting attaches TurfJet spray nozzles to Quick TeeJet vertical nozzle bodies. Specify color.

Item #	Price
171404	\$15.29
171404	\$15.29
171404	\$15.29
171404	\$15.29
171404	\$15.29
171404	\$15.29
171404	\$15.29
171403	\$4.69



Container-Rinsing Tool

This easy-to-use economical container-rinsing tool meets EPA triple-rinsing requirements

The Jet Rinse Triple-Rinsing Nozzle makes cleaning chemical containers easy. It allows for total usage of the chemical and also meets EPA triple-rinsing requirements for proper disposal or recycling of empty chemical containers. Simply attach it to your garden or nurse tank hose. Its sharp point will puncture the side or bottom of plastic or metal containers. Tool consists of two parts: a shut off handle that screws onto hose and a steel hand guard with heat-treated probe/nozzle.

Item #	Price
JETRINSE	\$39.99



TeeJet Calibration Container, 64 oz.

Safely collect chemicals and other types of liquids with this TeeJet Calibration Container

This high-capacity TeeJet Calibration Container is designed for mess-free spray collection from a variety of nozzle types and various spray angles. Large opening allows easy spray collection from different nozzle types and various angles. Polypropylene material provides excellent chemical resistance and durability. Graduations are raised for long-term readability.

Item #	Price
134210	\$35.99



Field Sprayer Calibrator

No more looking up complex calibration tables or charts! Displays exactly how many gallons per acre are being applied. Just attach the calibration bottle to any nozzle outlet on your sprayer. Travel a test distance of 150', then read the actual spray rate per acre on the bottle.

Item #	Price
127527	\$14.09



Digital Sprayer Calibrators

Accurate flow rate measurement in seconds

Provides help choosing the correct nozzle for the job or finding worn nozzles. Easy to use, lightweight and fast. Simple waterproof design has no moving parts and reads in gpm, oz./min. or L/min. Available in a 0.02-1.0-gpm model for most sprayer nozzles. Also available in 0.07-4.0-gpm model for high output fertilizer nozzles or irrigation nozzles. NOTE: Cannot be shipped to or sold in U.S. Territories or Internationally.

Item #	Price
167823	\$159.99
167824	\$227.99



Spray Paper

Spray pattern test paper

Spray paper won't warp in humid conditions. Tweezers and desiccant packet to improve longevity. 2-year shelf life.

Item #	Price
230699	\$26.99
230700	\$26.99



Water-Sensitive Cards

Test the effectiveness of spray nozzles

Check coverage, droplet size and drift. Water-Sensitive Spray Cards from TeeJet turn blue where water droplets hit them - showing spray density and penetration. Perfect for use in greenhouses, orchards, across field rows, in treetops, or to assess spray droplet patterns on new or modified equipment.

Item #	Price
TJC	\$64.29



QJ100 Tee

TeeJet Quick Dry Boom Nozzle Body Assemblies

Maximum operating pressure is 125 psi.

Item #	Hose I.D.	Style	Price
G48540	1/2"	Elbow	\$5.09
G48785	3/4"	Elbow	\$5.09
G42540	1/2"	Tee	\$5.09
G42785	3/4"	Tee	\$5.09



QJ300 Tee

TeeJet QJ300 Quick Dry Boom Nozzles

Maximum operating pressure is 300 psi.

Item #	Hose I.D.	Style	Price
G48750	3/4"	Elbow	\$9.19
G48500	1/2"	Elbow	\$9.19
139471	3/8"	Elbow	\$9.19
139472	3/8"	Tee	\$9.19
G42500	1/2"	Tee	\$9.19



TeeJet Vari-Spacing Clamps

Vari-Spacing Clamps for use on all dry booms Quick TeeJet Bodies 1- 1/4" Square Tubing.

Item #	Description	Price
G48114	1-1/4" Square Tubing	\$6.19
G48113	1" Sq Tubing	\$6.19
G48111	3/4" Pipe	\$6.19
G48112	1" Pipe	\$6.19



TeeJet Quick Caps and Gasket Sets

Designed with grooves that fit locating lugs on the nozzle body. Caps are made of nylon and are available for use with all spray tips. Maximum operating pressure of 300 psi For standard XR, TT and AIXR tips. Specify Color: Red or Yellow.

Item #	Description	Price
G45698	White	\$1.59
G45612	Yellow	\$1.89
G45612	Red	\$2.09



Triple Threat Broadleaf Herbicide

Triple Threat Broadleaf Herbicide is tough on weeds, yet gentle on grass

This water-dilutable, highly concentrated, selective herbicide controls a variety of broadleaf weeds, yet won't harm decorative turf or grasses. Mix 8 tsp. in 2 qt. water for poison ivy and poison oak control. Three active ingredients: 4.55% 2,4-DP, 2.29% MCPP and 2.26% 2,4-D.

NOTE: Do not apply to Dichondria, lippia, St. Augustine or clover lawns.

Note: not for sale in (AL;AR;CO;GA;LA;MA;VT;WA).

Item #	Container Size (Liquids)	FO	Price
214847	5 gal.	■	\$199.99
214846	1 gal.		\$42.99

■ Oversize item: additional shipping charges will apply.



Pre-Emerge and Post-Emerge Herbicide

Eliminates multiple chemical and mechanical weeding applications all season long

This ProDeuce Herbicide with Prodiamine combines pre-emerge and post-emerge herbicide to control weeds in gravel areas, sidewalks and driveway cracks, fence lines, foundations, curbs, retaining walls and mulched beds. Herbicide saves you time and labor and reduces plant damage from string trimmers. Features application rate of 3 to 6 fl. oz. per gal. of water per 1,000 sq. ft. Active ingredients: 40.15% glyphosate and 7.51% prodiamine. EPA registration number: 228-509.

NOTE: Not for sale in Alaska, Vermont or Washington state.

Note: not for sale in (AL;VT;WA).

Item #	HM	Price
198660	▲	\$56.99

▲ Requires special handling due to DOT regulations. Additional shipping charges will apply. Cannot be shipped by air.



Tordon® RTU Herbicide

Tordon RTU Herbicide effectively kills up to 20 species of cut stumps

Ready-to-use herbicide that's perfect for killing cut stumps when you're cleaning out fence lines, rights-of-way and other non-crop areas. Translocates into targeted root systems to eliminate resprouts. No freeze formula. Blue colorant helps keep track of treated stumps. Active ingredients are 5.4% picloram and 20.9% 2,4D.

NOTE: EPA registration number is 62719-31. Not for sale in AK, CA, FL, RI, VT or WA.

Note: not for sale in (AL;AR;DC;GA;RI;VT;WA).

Item #	HM	Price
171031	▲	\$27.99

▲ Requires special handling due to DOT regulations. Additional shipping charges will apply. Cannot be shipped by air.



Fusilade II Postemergent Herbicide.

Fast-acting herbicide controls unwanted grasses without harming desirable trees and plants

Contains 24.5% of the active ingredient fluzazifop for outstanding postemergence control of unwanted grasses in ground covers, shrubs and trees. Moves quickly into shoots, roots, rhizomes, stolons and growing points of the treated plants. Quickly arrests weed growth, with noticeable results within a week. Does not harm desirable broadleaf plants, conifers, newly emerging ornamentals or recent transplants. NOTE: Not for use around homes unless applied by licensed applicators.

Note: not for sale in (AL;GA;NE;NV;VT;WA).

Item #	Size	HM	Price
G49785	1 qt.	▲	\$109.99
226376	1 qt.	▲	\$23.49

▲ Requires special handling due to DOT regulations. Additional shipping charges will apply. Cannot be shipped by air.



Polypropylene Measuring Pitchers

Food-grade pitchers are extra-strong and chemical-resistant

Food-grade pitchers are extra strong and have a high chemical resistance. Graduations are debossed in black, making them easy to read. Unique handle features a finger hole for greater pouring stability and can easily be used with gloves.

Item #	Capacity	Price
151478	128 oz./4,000mL	\$15.39
160338	8 oz./250mL	\$5.59
160339	16 oz./500mL	\$6.59
160340	32 oz./1,000mL	\$8.29
160341	64 oz./2,000mL	\$9.99



GEMPLER'S

Polypropylene Measuring and Calibration Pitchers

Gempler's 2-qt. Measuring Pitcher provides excellent chemical resistance for long-lasting durability

Molded in high-density 100% virgin polypropylene for excellent chemical resistance and durability. Graduated with raised ounce and milliliter markings. Wide, tapered spout improves pouring accuracy. Open-ended handles are easy to grasp while wearing protective gloves.

NOTE: As expensive as some pesticide concentrates are, always calibrate any measuring cup for accuracy. Because they are mass-produced, there is a ±5% chance of error.

Item #	Capacity	Price
PP2Q	2 qt.	\$10.49
PPP	1 pt.	\$8.29
PPQ	1 qt.	\$9.29

1-gal. Polypropylene Measuring Pitcher

Easily measure up to a gallon of liquid

Chemical resistant, dentproof, rustproof, and boilproof, making them ideal for mixing chemicals, oil, gas, powders and more. Molded raised letter graduations in U.S., metric and imperial. Translucent so contents are visible. Big grip handle, wide tapered spout and sturdy nontip base.

Item #	Capacity	Price
G56801	87 oz./2.5L	\$14.99
G56800	155 oz./4.5L	\$19.99



GEMPLERS Polypropylene 10-oz. Precision Measuring Tube

Perfect for smaller-scale applications

Tapered polypropylene cylinder produces accurate measurements from 1 to 10 fl. oz. and from 25 to 300ml.

NOTE: As expensive as some pesticides are, always calibrate any measuring cup for accuracy.

Item #	Price
10GT	\$4.49

Chemical-Resistant Polypropylene Graduated Cylinders

Full-line products

Single scale uses raised milliliter graduations for easy readings. Autoclavable to 250°F.

Item #	Capacity	Price
F28456	200mL	\$12.49
F28458	1,000mL	\$24.49
F28459	2,000mL	\$31.79



Space-Saving Dispensing Systems

This convenient liquid dispenser is just what you need when you don't have a lot of room

Feature large fill openings and molded gallon graduations. Three shelf rack measures 14"W x 26"H x 15-1/2"D.

NOTE: Do not use with solvents or corrosive chemicals.

Item #	Capacity	Price
28812	2-1/2 gal.	\$14.39
28813	5 gal.	\$20.99





Tip 'n' Pour Polyethylene Measuring Containers

Accurately measure liquids such as oils, pesticides and engine additives

This Tip 'n' Pour Measuring Container is made of high-density polyethylene for chemical resistance. Accurately measure liquids such as oils, pesticides and engine additives.

Polyethylene has a high chemical resistance. Measurements in ounces are printed on the bottle.

NOTE: Bottle design received by customer may differ from photo shown.

Item #	Capacity	Price
171035	32 oz.	\$10.99
171036	64 oz.	\$11.49
171037	128 oz.	\$13.99
171034	16 oz.	\$9.99



Squeeze and Pour Measuring Containers

Convenient Squeeze and Pour measuring container allows you to quickly measure liquids just by squeezing

This Squeeze and Pour Measuring Container is made of high-density polyethylene for chemical resistance. Measurements are in ounces and milliliters.

NOTE: Bottle design received may differ from photo shown.

Item #	Price
171038	\$7.99
171039	\$8.99



Measuring Cups

A replacement for stainless steel measuring cups at a lower price

Industrial-grade "Bouncer" cups are lightweight and tough enough to stand on without breaking. Double scales (ounces and milliliters) on quart cups are etched in for long wear. Front pour spout directs stream.

NOTE: Not recommended for measuring pesticides.

Item #	Capacity	Price
R32	1 pt.	\$14.39
R32	2 qt.	\$21.29
R32	1 gal.	\$23.39



Stainless Steel Measuring Cups

A slightly conical shape makes reading the inside engraved measurements much easier. Design promotes stability and prevents tipping. Each cup has a pouring spout and an open handle that allows for easy storage. Graduations are in both milliliters and ounces.

Item #	Capacity	Price
109994	2 Cup	\$13.59
109995	4 Cup	\$17.99
109996	8 Cup	\$25.49

Landscape and Nursery Supplies

We supply gear to top landscapers and growers all across America, and they always tell us how we can make our products even better.

So you can be sure that whatever work you're doing, Gempler's products will help you get the job done easier, safer and faster.

And we're always on the lookout for the newest innovations in outdoor work.

NEW

**DEWALT FLEXVOLT®
60V MAX* Brushless
Chainsaw Kit**
DCCS670X1 on pg. 217



NEW

**DEWALT FLEXVOLT® 60V
MAX* Handheld Blower Kit**
DCBL770X1 on pg. 211



NEW

**Gempler's Leaf Burrito Reusable
Yard Debris Super Bag**
231237 on pg. 165



Felco® Classic Hand Pruner
F2 on pg. 186

GEMPLER'S®

DeWitt
DOWN TO EARTH PROTECTION

FELCO®
SWISS MADE

ARS

TOP BRANDS

Silky

CORONA®

BULLY TOOLS
Products that separate you from the herd.

DEWALT®

Landscape Tools & Supplies.....	156-182
Pruning Equipment.....	183-197
Gardening Tools & Supplies.....	198-199
Equipment.....	200-214
Brush Clearing.....	215-221
Tree & Plant Care.....	222-229
Marking Supplies.....	230-239

Surveying Supplies.....	240-243
Turf Management.....	244-253
Watering & Irrigation.....	254-267
Weather Monitoring.....	268-272
Greenhouse.....	273-274
Snow & Ice Removal.....	275-276



3-oz. Non-Woven Spunbond Weed Fabric

Professional-grade landscaping fabric lets the good stuff through while keeping the bad stuff down

Cost effective fabric mulch minimizes light penetration to suppress weed growth, yet allows water and air to pass through. When covered, the fabric is strong, durable and resistant to damage from extreme temperatures. Lightweight design is easier to cut than woven products.

Item #	Color	Size	FO	Price
139480	Black	4' x 300'	■	\$121.99
139479	Black	3' x 50'		\$16.59
226574	Black	6' x 300'	■	\$182.99
139481	Brown	3' x 50'		\$19.49
226570	Black	4' x 50'	■	\$19.99
226572	Black	3' x 100'		\$31.29



4-oz. Midweight Woven Weed Barrier

DeWitt 4-oz. Midweight Weed Barrier is easy to install and features sturdy polypropylene construction that WON'T tear or puncture when walked upon

The natural weave of woven fabrics allows better water, air and nutrient permeation. Woven for greater strength and much better puncture and tear resistance. Colored stripes spaced 12" apart for locating and aligning plants. Measures 4'W x 250'L roll. Anchoring pins sold separately.

Item #	Color	Size	FO	Price
139483	Black	4' x 250'	■	\$156.99
139484	Black	6' x 250'	■	\$219.99
RDWP4	Black	3'W x 50'L		\$26.99

■ Oversize item: additional shipping charges will apply.



5-oz. Heavyweight Woven Pro-5™ Weed Barrier

This DeWitt 5-oz. Heavyweight Weed Barrier is easy to install and features sturdy polypropylene construction that WON'T tear or puncture when walked upon

The heaviest-weight woven, needle-punched, polypropylene fabric around. It has all the benefits of the woven fabric above, plus added thickness for better puncture/tear resistance and soil moisture conservation. Anchoring pins sold separately.

Item #	Color	Size	FO	Price
RDWP5	Black	4'W x 250'L	■	\$155.99
RDWP6	Black	6' x 250'	■	\$259.99

■ Oversize item: additional shipping charges will apply.



Ultra Web 3000 Ground Cover Roll, 12'W x 300'L

This lightweight, tightly woven ground cover roll keeps your walking area dry, clean and free of weeds

The unique circular weave of the Ultra Web 3000 Ground Cover Roll allows water to pass through, but will not pull apart. It's perfect for greenhouses, nurseries and other growers for placement of containers. Weighs 2 oz. per sq. yd.

Item #	Color	Size	FO	Price
145501	Black	4' x 600'	■	\$155.99
145504	Black	12' x 300'	■	\$226.99
145502	Black	6' x 600'	■	\$234.99
145503	Black	8' x 600'	■	\$303.99

■ Oversize item: additional shipping charges will apply.



Precut Tree Squares

Controls weeds while allowing moisture, nutrients and air to get to the root zone

3-oz. woven polypropylene material prevents weed competition, string trimmer/mower injury and soil compaction. Permeable so that water, nutrients and air can get to the root zone. Hold in place with pins or mulch (sold separately).



Item #	Landscape & Nursery: Size	Type	Price
211943	3' x 3'	Solid	\$1.79
211945	3' x 3'	With X	\$1.79
211944	3' x 3'	With Slit	\$1.79
211947	4' x 4'	With Slit	\$2.29
211946	4' x 4'	Solid	\$2.49
211948	4' x 4'	With X	\$2.49



3-oz. Professional Landscape Fabric

This professional-grade landscaping fabric is guaranteed to inhibit weed growth for 20 years when properly installed

Spunbonded polypropylene material is strong enough for use under brick, stone or pavers, but is also porous to allow water, air and nutrients to pass through. 3-oz./sq. yd. fabric is lightweight, easy to install and guaranteed to inhibit weed growth for 20 years when properly installed. Durable, tear-resistant material does not rot or mildew and contains UV inhibitors. Its strength makes it an excellent choice under brick, block walkways or patios.

Item #	Width	Length	FO	Price
167813	4'	300'	■	\$135.49
167813	3'	50'		\$18.29
167813	6'	300'	■	\$202.99

■ Oversize item: additional shipping charges will apply.

Better Bilt Heavy-Duty Anchoring Pins

Each steel pin is angled for fast, easy installation. Use for landscape fabrics, ground covers, drip irrigation tubing and more!



Item #	Length	Qty. / Pkg.	Price
222017	8"	25	\$14.49
222018	10"	25	\$15.99



Biodegradable Paper Weed Barrier

Controls weeds while allowing air and water to get to your plants

100% opaque weed barrier made from cellulose fibers controls weeds and warms the soil to give your plants an earlier start. Naturally porous paper eliminates weeds but allows air and water to penetrate. Can be tilled into the soil or left to degrade at the end of the season. Made from renewable resources, with no petrochemicals.

NOTE: Standard weight is allowed for use in organic plantings under the USDA National Organic Program Code 205.601. OMRI Listed.

Item #	Type	Width	Length	FO	Price
201401	Standard Weight	24"	50'		\$12.99
215076	3-3-3 Fertilizer Enriched	24"	50'		\$16.39
215077	Heavyweight	24"	50'		\$16.59
201401	Standard Weight	36"	50'		\$18.39
215076	3-3-3 Fertilizer Enriched	36"	50'		\$21.89
215077	Heavyweight	36"	50'		\$24.49
201401	Standard Weight	48"	50'	■	\$29.99
215077	Heavyweight	24"	150'		\$31.59
215077	Heavyweight	48"	50'	■	\$32.49
201401	Standard Weight	24"	250'		\$34.99
215077	Heavyweight	36"	150'		\$41.99
215076	3-3-3 Fertilizer Enriched	24"	200'		\$42.49
201401	Standard Weight	36"	250'		\$46.29
215077	Heavyweight	48"	150'	■	\$52.99
201401	Standard Weight	48"	250'	■	\$55.99
215076	3-3-3 Fertilizer Enriched	36"	200'		\$57.59
215076	3-3-3 Fertilizer Enriched	48"	200'	■	\$68.49

■ Oversize item; additional shipping charges will apply.



Reusable Seed Guard Fabric

Protect newly planted seeds from rain, wind, birds and insects

Reusable polypropylene fabric protects your newly seeded lawn from potential losses due to rain, wind, birds, insects and even late frosts. Provides a 90-95% seed germination rate under favorable conditions, compared to 65% when using hay or straw. Cleaner and easier to remove than other covers and won't introduce weeds into your new yard. Fabric weighs 0.5 oz. per square yd. and is treated to minimize UV deterioration. Remove fabric 2-3 weeks after seeding or before mowing.

Item #	FO	Price
152010	■	\$199.99

■ Oversize item: additional shipping charges will apply.



Landscape Fabric Anchor Re-Pins

DeWitt Landscape Fabric Anchor Re-Pins secure any kind of temporary landscape covering

Durable plastic pins are ideal for all types of temporary landscape coverings. The highly visible red stakes have a looped top for easy installation and removal. UV treated for long life.

Item #	Qty./Pkg.	Price
139524	300	\$63.29

NOT FOUND: 145531



Plain Burlap Rolls

This Burlap Roll is perfect for nurseries and professional garden centers

This Burlap Roll works great when you need a specific size cut for applications where a pre-cut square isn't the most economical choice.

NOTE: Item Nos. 186094, 186095, 189096, 186097, 186098, 186099, 192891, 192904, 192905, 192906, 192907, 192908, 192909, 192910 and 192911 are shipped by motor freight. Charges to be determined when order is placed.

Item #	Width	Length	Weight Per Square Yard	FO	FT	Price
192886	40"	100 yd.	10 oz.	■		\$104.99
192888	48"	100 yd.	10 oz.	■		\$124.99
192889	54"	100 yd.	10 oz.	■		\$135.99
192890	60"	100 yd.	10 oz.	■		\$154.99
186093	32"	250 yd.	7 oz.	■		\$175.99
186094	36"	250 yd.	7 oz.	■		\$189.99
192891	72"	100 yd.	10 oz.		*	\$193.99
192904	32"	250 yd.	10 oz.	■		\$222.49
186096	48"	250 yd.	7 oz.		*	\$249.99
192906	40"	250 yd.	10 oz.		*	\$254.99
192908	48"	250 yd.	10 oz.		*	\$305.99
186098	60"	250 yd.	7 oz.		*	\$307.99
186099	72"	250 yd.	7 oz.		*	\$379.99
192910	60"	250 yd.	10 oz.		*	\$385.99
192882	12"	100 yd.	10 oz.			\$44.99
192911	72"	250 yd.	10 oz.		*	\$479.99
192883	18"	100 yd.	10 oz.			\$62.49
192884	32"	100 yd.	10 oz.			\$92.99
192885	36"	100 yd.	10 oz.	■		\$94.99

*Item ships by Truck due to size and weight.

■Oversize item: additional shipping charges will apply.



Natural Biodegradable Erosion Control Blanket

Give grass seeds a fighting chance to grow by halting wind and water erosion with this landscape blanket

Curlex Natural Fiber Landscape Blankets promote ideal growing conditions for grass seed while providing necessary erosion control. Works best for slopes 2:1 or less and areas of light to moderate rainfall and runoff. Anchoring pins, item numbers and , sold separately.

Item #	Material	Size	FO	Price
60917	Aspen Wood Fibers	4' x 101'	■	\$46.99
60918	Aspen Wood Fibers	4' x 101'	■	\$50.99

■Oversize item: additional shipping charges will apply.



Recycled Vinyl Landscaping Edging Kits

Easy-to-use edging offers extreme versatility
Vinyl edging kits give your landscaping projects a professional look.

No-Dig Landscape and Paver Edging Kits have unique L-shaped pieces that can be used as a restraint or as 1-1/2"H edging.

16'L Edging Kit includes four flexible 4'L sections, 4 connectors and 8 anchoring spikes.

24'L Edging Kit includes four 6'L sections, 4 connectors and 8 anchoring spikes.

Item #	Description	Length	FO	Price
226654	160'L Coil	160'		\$108.99
226655	240'L Coil	240'	■	\$149.99
210527	Extra Spikes, Pkg of 4			\$2.99
171058	16'L Edging Kit		■	\$24.99
210526	24'L Edging Kit		■	\$35.99

■ Oversize item: additional shipping charges will apply.



Aluminum Edging Kits

Aluminum edging has many advantages over vinyl, plastic or steel edging, making it less expensive over the life of the product. Will not become brittle, crack, rust or rot. Lightweight recycled aluminum edging produces straight lines but can also be easily formed around curves and cut to length. Each section of 1/8"-thick x 4"H edging is 8'L and ideal for residential or light commercial applications. Kits include edging, stakes and end stake adapters.

Note: This item is priced per case.

Item #	Landscape & Nursery: Color	FT	Price
167963	Silver	*	\$251.29
167964	Green		\$307.99
167964	Black		\$308.99

*Item ships by Truck due to size and weight.



TEITAX® Turf Protection Mesh

Turf reinforcement mat is ideal for applications where traffic is less frequent and the turf has time to recover between passes. Roll the mesh out just after mowing and secure with anchoring pins (Item # 145531 or 145588, sold separately). Package contains two 20'L x 3.35'W sections.

NOTE: Although this is the most slip resistant grass protection mesh available, we cannot account for all the variances in conditions. Until the grass has grown through the mesh and become established, the ground protection products may be slippery in wet icy conditions.

Item #	Description	FT	Price
215196	100'L x 6.7'W Roll	*	\$249.99
167789	20'L x 3.45'W Rolls		\$40.99

*Item ships by Truck due to size and weight.



Rubber Mulch Tree Rings

Protect your young trees from hungry animals and damaging lawn care equipment, and eliminate the need to mulch every year

Fade-resistant rings allow water, air and nutrients to pass through, yet act as a barrier to weed growth. You can even mow over them. 100% recycled-tire mulch rings are maintenance-free and will not discolor, decompose or blow away. To install, just remove 1/2" of sod or soil around your tree, then slip the pre-cut ring around the tree so the ring lays flush with the surrounding turf. Specify Color: Brown or Red.

Item #	Landscape & Nursery: Color	Landscape & Nursery: Size	FO	Price
221834	Brown	36" dia.	■	\$19.99
221833	Brown	24" dia.		\$9.99

■ Oversize item: additional shipping charges will apply.



Tree Mat Circles

Tree Mat Circle conserves moisture and controls weeds - giving your young trees and shrubs a growing chance

Ideal for newly planted trees or random tree and shrub plantings. Heavy-duty plastic fabric blocks sunlight to inhibit weed growth but is permeable to allow air, moisture and nutrients into the soil. Slit in the fabric allows easy installation. Does not require rock or mulch to cover. Green color blends in with grass. Use with the DeWitt Tree Watering Bag (#217816) for complete tree care.

Item #	Landscape & Nursery: Size	Price
226139	3'	\$1.99
226140	4'	\$2.99



Rubber Mulch

100% recycled rubber mulch resists fading better than hardwood mulches, plus it's five times heavier, so it stays where you put it

This rubber mulch is made from 100% recycled rubber (99.9% wire-free and nontoxic) and is ideal for commercial landscaping applications and as a playground surface. Resists fading better than hardwood mulches, plus it's 5x heavier, so it stays put. 1/2" to 2" mulch nuggets won't absorb water or erode during heavy rains. Doesn't attract termites, carpenter ants or other harmful insects. Specify Color: Brown or Red.

Item #	Price
221819	\$7.59



Perforated Red Mulch Film

Increase your tomato yields by up to 20%

This Red Mulch Film is designed to reflect red light back to your tomato plants to stimulate growth while helping retain moisture, control weeds and warm the soil. Can also be used with strawberries and red peppers. 3"W x 24"L roll.

Item #	Price
221415	\$8.49



EnviroColor® Mulch Colorant

Spruce up faded pine straw and mulch with EnviroColor Mulch Colorant

Give pine straw and mulch a new life with just one application. Safe formulation for plants, pets and wildlife. Apply with a simple pump sprayer. Water-based formula will not damage plants, trees or shrubs--just spray them with water prior to use. All-natural iron oxide and carbon solution protects against UV light, rain and other environmental hazards for months. Nontoxic and nonflammable. Specify Color: Black, Brown, Pine Straw or Red.

Item #	Landscape & Nursery: Size	Price
226399	2.5 gal.	\$149.99
226397	1 qt.	\$25.99
226398	1 gal.	\$69.99



Rubber Pavers

Made from 100% recycled, long-lasting rubber, these bricks are virtually maintenance-free and won't freeze or crack

Great for patios, balconies, decks and garage floors. Made from 100% recycled, long-lasting rubber, these bricks won't freeze or crack. Grooved bottoms channel away water. Noise and impact absorbent. Virtually maintenance-free. Install with a polyurethane adhesive (sold separately). 16"L x 16"W x 3/4"H. Specify Color.

NOTE: Not designed to be used over soil or turf. Some natural weathering may occur.

Item #	Price
221835	\$5.69



DOT Reacher™, Non-Locking, Extra-Strong Pick-up Tool

Rubber pick-up grippers can grasp objects as small as a dime or as heavy as a 5-lb. brick

The DOT Reacher, Non-Locking, Extra-Strong Pick-up Tool lets you quickly and safely clean up highways, golf courses, parks, beaches and lawns. It's also ideal for retrieving objects from hard-to-reach places like high shelves or for sanitary cleanup in restrooms. Tool is non-locking. Replacement rubber cups (Item # 159891) sold separately.

NOTE: The handle is included in the length.

Item #	Length	FO	Price
159879	23"		\$18.99
159880	32"		\$20.99
159881	40"		\$22.99
159882	48"	■	\$23.99
159883	60"	■	\$25.99
159884	72"	■	\$28.99

■ Oversize item: additional shipping charges will apply.



Industrial-grade mesh will not tear or collect water like plastic trash cans and bags



Fill



To the top!



Drag



Dump!

NEW

GEMPLERS Leaf Burrito Reusable Yard Debris Super Bags

Reusable! Keeps single-use plastic bags out of our landfills

The Leaf Burrito is an ingenious new yard debris system that makes the arduous task of bagging leaves, hedge clippings, weeds, sticks, and grass clippings be an incredibly simple and eco-friendly experience! It starts completely flat for instant loading then burritos up with heavy duty zippers. The 5' residential burrito holds 4+ large plastic bags of leaves and the 7' commercial burrito holds 6+ bags.

Item #	Length	Price
231237	5'	\$69.00
231237	7'	\$84.00



Landscaping Bags

Use these collapsible yard bags to make short work of landscape and debris cleanup year-round

These huge Landscaping Bags are constructed of durable woven plastic strands to be lightweight and resistant to punctures.

Item #	Capacity	Price
221034	22 cu. ft.	\$49.99
83434	27 cu. ft.	\$51.99



Collapsible Trash Can and Landscaping Bag

Get the toughness and durability of heavy trash cans with the light weight and portability of a collapsible model

This heavy-duty trash can collapses completely and locks, making it easier for you to store and transport compared to larger, bulkier trash cans. Use indoors or outdoors - this can is tough enough to handle any job. Fits standard 55-gal. trash bags, making it ideal for leaves, trash, garden debris and more.

Item #	Price
179156	\$39.99



BIGmouth Shoulder Bag

Spend more time collecting trash and less time emptying the bag with this easy to use, large-capacity shoulder bag

This BIGmouth Shoulder Bag features a 16"-dia., steel-rimmed opening that holds the bag open and makes it easy to toss in items for faster grounds maintenance. 1.5 lb.

Item #	Price
160202	\$41.99



DRAMM® Lightweight Trash Tongs

Pick up items as small as a penny without bending over
 These handy, lightweight tongs save your back by eliminating the need to bend over to pick up trash. Weighs 1 lb.

Item #	Price
2928	\$34.79



DeWitt Leaf and Debris Tarps

This leaf and debris tarp is made of 3.2-oz. polypropylene so it's highly resistant to punctures and tears making it perfect for landscaping and lawn-maintenance. This tarp features built-in loop handles so it's easy to move around the yard when full of leaves.

Item #	Price
224677	\$12.99



DeWitt Flexible Bulk Container

Store or transport up to 2,000 lb. of material with this reusable bulk bag

Made of strong, UV-resistant woven polypropylene, each bulk bag is ideal for storing and transporting dry, flow-able products like sand, fertilizer or mulch. Easily lifted by a forklift or skid steer using the four support loops. Bag is unloaded through a discharge spout in the bottom, which is secured with rope.

Item #	Length	Height	Width	Price
217817	25-1/2"	27-1/2"	25-1/2"	\$15.99



RUGG Leaf and Grass Grabbers, 1 pr.

Increase the surface area and grabbing capability of your hands

Leaf Grabbers give you an easy way to gather and move piles of leaves, twigs or grass clippings. They also provide better control when removing debris next to plants or from landscaped areas. One pair.

Item #	Price
230735	\$9.99



3-Trimmer Truck Rack

Safely take your trimmers and landscaping tools to the jobsite

This TrimmerTrap Trimmer Rack attaches to the upper and lower rails of your trailer to carry up to three trimmers, edgers or long-handled tools.

Item #	FO	Price
227135	■	\$227.89

■ Oversize item: additional shipping charges will apply.



4-Trimmer Rack

Trimmer rack makes loading and unloading trimmers and landscaping tools quick and easy

High quality TrimmerTrap Trimmer Rack is constructed of heavy-ga. steel that's powder coated for durability and rugged enough to withstand years of heavy commercial use. This TrimmerTrap 4-Trimmer Rack is designed for easy operation and lockable with a padlock to prevent theft of your equipment. Rack attaches to upper and lower trailer rails (stronger than racks that attach only to the top rail) and carries up to four trimmers, edgers, long-handled tools or any combination.

Item #	FO	Price
227138	■	\$274.99

■ Oversize item: additional shipping charges will apply.



Trimmer Rack

Trimmer rack make loading and unloading quick and easy

High quality TrimmerTrap Trimmer Rack is constructed of heavy-ga. steel that's powder coated for durability and rugged enough to withstand years of heavy commercial use. This TrimmerTrap Rack is designed for easy operation and lockable with a padlock to prevent theft of your equipment. Rack attaches to upper and lower trailer rails (stronger than racks that attach only to the top rail) and carries one trimmer, edger or long-handled tool.

Item #	Price
227142	\$70.79



2-Trimmer Rack

Safely take your trimmers and landscaping tools to the jobsite

This TrimmerTrap Trimmer Rack attaches to the upper and lower rails of your trailer to carry two trimmers, edgers or long-handled tools.

Item #	Price
227136	\$141.49

A Rough-n-Tough Shop **MUST HAVE!**

★★★★★ "I had all my brooms, shovels and rakes stacked up against one wall. What a mess! I hung three of these units on my wall and I freed up all that floor space while organizing my tools."

—Max PC Williams in Raleigh, NC



GEMPLER'S

Best Tool Rack... EVER!

American-made quality construction

Seriously impressive. Made of heavy-gauge steel that's welded to a base so you can load it up with tools, hoses, cords and more. Powder-coated to prevent rust. Choose from wall-mount or stud-mount racks. Stud-mount rack (Item # 217726) features 5/16" dia. steel rods (instead of steel tubing).

Item #	Description	Space Between Tubing	Price
Complete Broom Kits			
HR12	12"L, two-tine, wall-mount	1-1/2" W	\$15.99
HR13	Long, 20" two-tine, wall-mount	1-1/2" W	\$21.99
HR16	Wide 12"L, two-tine, wall-mount	2-7/8" W	\$19.99
HR18	12"L, single-tine, wall-mount	1-1/2" W	\$15.99
217725	12"L, two-tine, stud-mount	1-1/2" W	\$17.99
217726	12"L, Economical stud-mount	1-1/2" W	\$15.79



HR12
Ideal for shovels,
spades, rakes
and brooms

HR13
Great for crews needing
large quantities of
similar tools



HR16
Wider for
trimmers, blowers
and stepladders

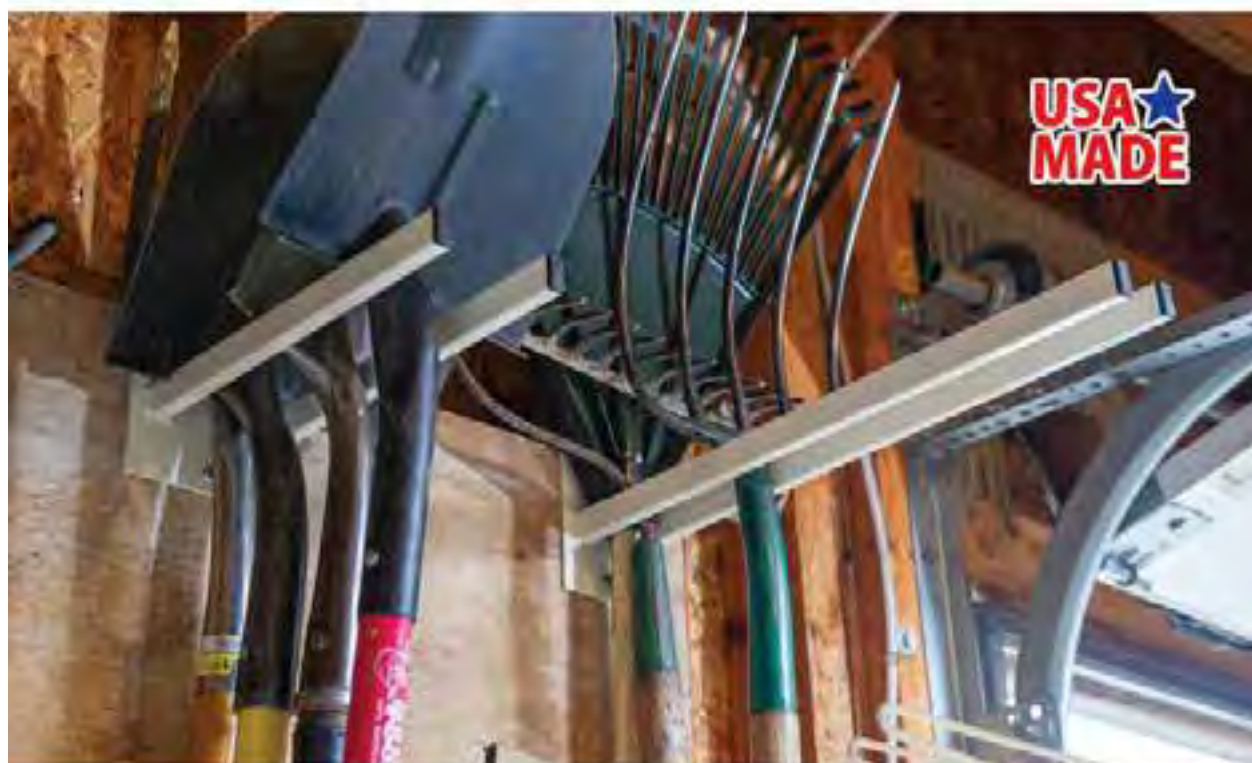

HR18
Great for electric
cords, hoses, loppers
and shears



217725
Same as HR12, but
for unfinished walls



217726
Use less material to
save you money



10-Hook Utility Rack

Hang all your landscaping tools, shovels, rakes, cords and hoses

This 10-hook rack is perfect for storing rakes, shovels and many other long-handled landscaping tools.

NOTE: Mounting nails and screws not included.

Item #	Price
G54135	\$39.99



Portable Double-Wire Utility Hooks

A simple way to organize your workspace

Select type and length of hook from the drop-down menus above.

Item #	Length	Type	Price
G54130	4"	Utility Hook	\$6.89
G54131	8"	Utility Hook	\$6.89
G54132	15"	Utility Hook	\$6.99
G54134	30"	Utility Hook	\$8.49
G54133	15"	Cement Block Hook	\$9.69



Wood Handle Poly Scraper, 24"

Easily push or scrape snow, dirt, grain, manure, water or oily wastes

These poly scrapers are the most durable on the market. Select from either a 54"L straight wood handle or the 49-1/2"L heavy-duty stainless steel D-handle. Blades are made of the same tough UHMW polymer used on replacement plow mold boards. Outwears and outpushes heavier scrapers, with less resistance. Built to last, with galvanized steel braces to stabilize the scraper and reduce strain on the handle. 14" thick blade is reversible and wears sharp.

Item #	Blade Width	FO	Price
CF1018	18"	■	\$37.29
CF1024	24"	■	\$43.99
CF1036	36"	■	\$59.99
CF1048	48"	■	\$68.99

■ Oversize item: additional shipping charges will



Stainless Steel Scraper

All-welded construction withstands the toughest jobs

This rugged scraper is as tough as they come. Constructed from 12-ga. stainless steel to tackle heavy-duty jobs such as scraping gutters, stalls, grain bins and packed-down ice on concrete and pavement.

Item #	FO	Price
F1224	■	\$63.59

■ Oversize item: additional shipping charges will apply.



Posthole Digger

Tackle fencing jobs quickly and with confidence

This Bully Tools Posthole Digger lets you tackle fencing jobs quickly. Select size of spread width from the drop-down menu above.

Item #	Landscape & Nursery: Size	FO	Price
171325	5"	■	\$54.99
171326	6-1/2"	■	\$65.99

■ Oversize item: additional shipping charges will apply.



Power Planter Soil Augers

Speed up planting in all types of soil. When planting flowers and trees, these tools create loose soil in and around holes to improve soil-to-root contact and reduce death loss. Other uses: Mixer--polymers, soil and fertilizer with peat moss in planter boxes; paints and small batches of cement and mortar. Hole digger--for fencing and real estate signs, also for talking soil samples. Hand welded to guarantee quality. NOTE: Drill not included and shown for illustrative purposes only.

Item #	Diameter	Length	Type	Price
226388	7"	28"	Regular	\$119.99
226378	2"	7"		\$16.99
226379	3"	7"		\$22.59
226380	3"	12"		\$28.29
226383	3"	24"	Regular	\$43.49
226381	2"	24"	Regular	\$65.99
226385	4"	28"	Regular	\$78.99



No product name

Use this shovel to dig through hard, compacted soil and you'll understand how the King of Spades has earned its name

King of Spades offers an optional large rubber footpad that can be bolted to either side of the blade step for added digging comfort and stability. 6.4 lb. Replacement footpads, W418, sold separately.

Item #	Description	Price
W418	Replacement Footpad	\$10.49
W419	Spade	\$89.99



Floral Shovel

The perfect shovel for working in close quarters and around tightly spaced plantings

This Floral Shovel has a small head that measures 8-1/4"L x 6"W - making it the perfect shovel for working around closely spaced plants. Weighs 2 lb.

Item #	FO	Price
160354	■	\$37.99

■ Oversize item: additional shipping charges will apply.



#10 Long-Handled Aluminum Scoop Shovel

Get long-handled leverage and reach with the versatility of an aluminum scoop

The aluminum blade on this #10 Long-Handled Scoop Shovel is lightweight to reduce fatigue while you work, but still strong and sturdy enough to handle moving animal feed, snow or general cleaning. Shovel measures 62"L overall with a 48"L ash handle. Blade measures 14-3/4"W x 18"L. Weighs 4 lb.

Item #	Blade Length	FO	Price
221750	18"	■	\$42.99
221756	19"	■	\$46.99
221757	20"	■	\$51.49

■ Oversize item: additional shipping charges will apply.



Handles are tough enough to drive over with a truck

Welded steel rib adds strength to the round and square point shovels



"My wife and I operate a small organic farm and vegetable garden. We have been using three Bully Tools hoes for a year. They are excellent! We've used the shovel for only a couple of weeks, but I expect it will also be great."

- iracohen



Long-Handled Square Blade Shovel

Dig this - unsurpassed durability and an unconditional guarantee against breakage

This Bully Tools Long-Handled Square Blade Shovel gives you unsurpassed quality. 56"L overall. 5.4 lb.

Item #	Overall Length	Head Type	FO	Price
167608	56"	Square Blade	■	\$33.99
167607	56"	Round Point	■	\$33.99
167759	45"	Round Point		\$33.99
167760	45"	Square Blade	■	\$33.99
167609	40"	Square Blade		\$42.39
167768	45"	Round Point		\$42.39
167769	59"	Round Point	■	\$42.39
167767	59"	Round Point	■	\$42.39

■ Oversize item: additional shipping charges will apply.



BULLY TOOLS Trenching Shovel

This Bully Tools Trenching Shovel is ideal for small trenching jobs

This rugged Bully Tools trenching shovel is ideal for small trenching jobs. Features fiberglass handles and 14-ga steel blades angled for efficient digging. Cleanout shovels have added feature of sides that help keep soil in the blade.

Item #	Blade Width	FO	Price
171318	3"	■	\$33.99
171319	4"	■	\$33.99
171322	4"	■	\$35.99
171320	5"	■	\$35.99

■ Oversize item: additional shipping charges will apply.



BULLY TOOLS Poly Scoop Shovel with D-Handle

When it comes to this Poly Scoop Shovel, longer is better - better for your back!

At 53-1/2"L, this Bully Tools Poly Scoop Shovel is a full 8" longer than most other scoops - making it easier to use with less back strain. Need more options?

Item #	FO	Price
167761	■	\$38.19

■ Oversize item: additional shipping charges will apply.



BULLY TOOLS Caprock Irrigation Shovel

Get the right shovel for the job - this shovel is perfect for irrigation jobs because the flat blade digs straight down instead of at an angle

This Bully Tools Caprock Irrigation Shovel features a forged blade that provides added strength and measures 9-3/4"L x 9"W. 48"L fiberglass handle. 7.5 lb.

Item #	FO	Price
217676	■	\$58.29

■ Oversize item: additional shipping charges will apply.



Inverted Y cutting blade tip, it severs roots up to 2" in diameter in a single pass

Original Root Slayer Shovel

Now go after those roots!

With its inverted Y cutting blade tip, it severs roots up to 2" in diameter in a single pass. Specially designed rip-saw teeth effectively cut larger roots. Use it to cut out shrubs and bushes, plant perennials, divide hostas, even dig out dandelions without bending over. Rugged high carbon steel. Innovative O-handle has 4 times the gripping surface of traditional D handles, giving you more digging power and easing hand and arm fatigue. Total length 44.5"; blade length 13"; blade width 10.5" at top of step. Weighs 5 lbs. 8 oz.

Item #	FO	Price
231017	■	\$49.99

■ Oversize item: additional shipping charges will apply.



Nomad Compact Shovel

Smaller blade for a more lightweight feel.

Compact version of the Original Root Slayer shovel, the Nomad has a 70% smaller blade for a more lightweight feel without sacrificing the sharp edges and strength. Inverted Y cutting blade tip severs roots in a single pass. Great for digging in small spaces, raised beds and campgrounds. This shovel is an excellent weeding tool to uproot Spotted Knapweed, Ash seedlings, Bladder Campions, even dig out dandelions, and more without bending over. Non-bending, powder-coated carbon steel shaft. Ergonomic polypropylene grip on handle. Total length 39"; blade length 9"; blade width 7.5" at top of step. Weighs 2 lbs. 7 oz.

Item #	Price
231015	\$39.99



Mini Digger

Fantastic traveling tool.

Multi-purpose digging tool for smaller spaces, raised beds, camping trips and more. Inverted Y cutting blade has sharp edges for cutting through roots with ease. Innovative O-handle has 4 times the gripping surface of traditional D handles, giving you more digging power and easing hand and arm fatigue. Tempered mid-carbon steel blade, fiberglass shaft and polypropylene/TPE grip. Total length 29"; blade length 9.25"; blade width 7.5" at top of step. Weighs 2 lbs. 12 oz.

Item #	Price
231013	\$29.99



REMCO Poly Scoop Shovels

This REMCO White Poly Scoop Shovel is built so tough, you can drive a truck over it!

This Remco Poly Scoop Shovels are practically indestructible. Made from extremely durable polypropylene, they resist chemicals and won't corrode. Specify color White, Yellow, Pink, Green, Blue, Purple, Black, Gray, Orange, Red, Lime or Brown.

Item #	Blade Length	Blade Width	Price
G6981	14"	11"	\$56.49
6982	17"	14"	\$56.79



CORONA Short D-Grip #12 Steel Scoop Shovel

Shovel head is made of high-carbon steel for added strength and durability

This Corona Short D-Grip #12 Steel Scoop Shovel features a thick, 14-ga. tempered steel blade that holds up better than aluminum and 30"L D-handle made with sturdy American Ash. Weighs 7.1 lb.

Item #	FO	Price
148021	■	\$51.99

■ Oversize item: additional shipping charges will apply.



SEYMOUR MIDWEST Poly Scoop Shovel

Make large shoveling jobs a little bit easier with a super-strong shovel that weighs only 4-1/2 lb.

Durable shovel provides excellent strength but is lightweight, making those large shoveling job a bit easier. Large #12 scool is ideal for moving snow, grain, seed, feed, fertilizer or other granulated materials. 30"L hardwood handle features a large poly D-handle that accomodates most hands, even when wearing gloves.

Item #	Price
167943	\$35.99



RAZORBACK #14 Aluminum Scoop Shovel

Lightweight but tough enough to handle almost any material

Don't let the light weight fool you! The Razor-Back #14 Aluminum Scoop Shovel is tough enough to move grain, seed, feed, fertilizers, mulch, sand and soil.

Item #	FO	Price
226689	■	\$83.49

■ Oversize item: additional shipping charges will apply.



Rogue Field Hoe

Great multitasking field hoe for farming, landscaping, gardening and more

Each high-grade tempered steel blade is made from recycled agricultural disc blades, and most are sharpened on three sides. They really hold an edge! Strong enough for breaking up sod or clearing small waste trees.

- **Durable Blades:** High-grade tempered steel blades are made from recycled agricultural disc blades for durability
- **Superior Cutting Power:** Sharpened on three sides for added slicing power through tough material

Item #	Handle Length	Handle Material	Head Width	FO	Price
109817	60"	Hardwood	5-1/2"	■	\$33.49
G42025	60"	Hardwood	7"	■	\$33.49



Hoe Rake

Get two tools in one with this Rogue Hoe Hoe Rake

Feel the difference of hand-crafted quality with the Rogue Hoe Hoe Rake. Each super-sharp blade is sharpened on three sides, so they really hold an edge!

Item #	Handle Length	Handle Material	FO	Price
228462	54"	Ash	■	\$53.99
228463	48"	Ash	■	\$53.99
228464	40"	Hickory		\$54.99
228465	54"	Fiberglass	■	\$61.99

■ Oversize item: additional shipping charges will apply.



GEMPLERS Cowhide Leather Gloves

These quality gloves are generously sized. A keystone leather thumb ensures the best possible dexterity. Drawstring back can be pulled snug around the wrist to keep out debris and reduce slippage.

Item #	Size Range	Price
650L	S-XL	\$14.99



BULLY TOOLS Garden Hoes

A great tool for both pros and Joes to chip, weed or plant

Durable, lightweight fiberglass handles
Choose the hoe you need for your specific application.

Item #	Description	FO	Price
192131	Loop Hoe	■	\$24.99
192130	Beet	■	\$27.29
167764	Garden Hoe	■	\$33.99
167765	Warren Hoe	■	\$33.99
167766	Cavex Hoe	■	\$33.99

■ Oversize item: additional shipping charges will apply.



Weed Remover

The original stand-up weeding tool removes weeds without bending, pulling or kneeling

A simple design, that works! Grampa's Weeder is an ingenious tool that lets you to remove stubborn weeds, root and all. This ingeniously designed tool was invented in 1913 in Seattle, Washington and people living in the Great Northwest quickly made it the must-have garden tool for getting rid of weeds quickly and easily. Lightweight at 3.2 lb. Handle Length 39".

Item #	Price
151206	\$24.99



Broadfork

Quickly break up packed soil

This Bully Tools Broadfork is a great tool for landscapers and homeowners to use in gardens and other small areas. It helps you easily break up densely packed soil so plants can get more air, water and nutrients. 54" overall length.

Item #	Price
198648	\$81.29



5-Tine Manure Pitchfork

This Five-Tine Manure Pitchfork features a longer handle for taller people

This Five-Tine Manure Pitchfork offers exceptional quality compared to most forks found at retail stores. Features a 54"L American hardwood handle with UV-resistant coating. Weighs 3.9 lb.

Item #	Handle Length	FO	Price
156252	48"	■	\$38.49
156253	54"	■	\$39.99

■ Oversize item: additional shipping charges will apply.



Ensilage Fork

10-tine Ensilage Fork is perfectly designed for a variety of loose materials

This Razor-Back Ensilage Fork has a forged-steel head with 10 tines spaced 1-1/2" apart. 30"L hardwood handle/46-3/4"L overall. Head measures 15-5/16"W.

Item #	FO	Price
226699	■	\$119.79

■ Oversize item: additional shipping charges will apply.



Spading Forks

Takes on heavy, rocky soils without bending

Take on heavy, rocky soils without bending. Itewonm # 227544 features all-steel construction, and 1/2"-dia. square steel tines. Item # 167762 features a fiberglass handle with 7"W head and 10"L tines.

Item #	Overall Length	Price
167762	44"	\$33.99
227544	46-1/2"	\$39.99



Handcrafted Steel Rake

Rake, scrape and level your lawn and garden

This Handcrafted Steel Rake is one of the strongest steel rakes we've found.

Item #	Head Width	FO	Price
D1800	18"	■	\$59.99
D2400	24"	■	\$67.99
D3000	30"	■	\$72.99

■ Oversize item: additional shipping charges will apply.



MIDWEST RAKE ProGrade Spring Brace Lawn Rake

These heavy-duty rakes take on the biggest yards

This commercial-grade, Midwest Rake ProGrade Spring Brace Lawn Rake is just right for all your home, garden and landscaping projects. 54" Aluminum handle, 24 tines.

Item #	Head Width	FO	Price
139344	24"	■	\$29.99

■ Oversize item: additional shipping charges will apply.



band Spring Brace Rake

This Spring Brace Rake flexes for better ground coverage with less effort

The spring brace style allows this rake to flex better while raking - resulting in better ground contact without back-breaking effort. Rake weighs 2.4 lb. 54" Hardwood handle.

Item #	Head Width	FO	Price
150304	24"	■	\$13.49

■ Oversize item: additional shipping charges will apply.



18"W Stone Rake

The perfect tool to make landscaping easy

This Bully Tools 18"W Stone Rake measures 66"L overall and weighs 3.5 lb.

Item #	FO	Price
226133	■	\$33.49

■ Oversize item: additional shipping charges will apply.



Long-Handled Bow Rake

Wrap up your landscaping chores in a snap with this tough, yet lightweight Bully Tools Long-Handled Bow Rake

Yard work doesn't need to be a chore when you're using Bully Tools Long-Handled Bow Rake. This well-balanced rake features a tough, yet lightweight fiberglass handle and a 16"W head. Measures 60"L overall length. 3 lb.

Item #	FO	Price
167763	■	\$31.69

■ Oversize item: additional shipping charges will apply.



8"W Shrub Rake

Sleek but sturdy, ideal for tighter spaces

This well-built Bully Tools shrub rake is ideal for tight spaces.

Item #	Price
171328	\$18.49



Poly Leaf Rake

Lightweight but long-lasting with premium tines for superior raking

The Bully Tools Poly Leaf Rake is lightweight to minimize fatigue, but strong for a long life. Features premium polypropylene tines, a 41"L fiberglass handle and 72" overall length.

Item #	Head Width	FO	Price
226129	24"	■	\$26.49
226131	30"	■	\$28.99

■ Oversize item: additional shipping charges will apply.



ARS Telescopic Hedge Shear

Extendable handles make trimming easier

These ARS hedge shears have durable aluminum handles that telescope to three different positions, giving you the extra leverage and reach needed for tall bushes or deep shrubs. Blade length 6-3/4", overall length 28" to 41-1/2"

Item #	Price
139304	\$71.99



BAHCO Professional Hedge Shears

These Bahco Professional Hedge Shears cut larger twigs with ease

These Bahco Professional Hedge Shears feature hardened steel blades with notches near the bottom, allowing you to cut larger twigs and branches without much effort.

Item #	Length	Price
182066	23"	\$74.99
182067	30"	\$79.99



ARS 25" Lightweight Hedge Shear

ABS Professional Hedge Shears are light enough to reduce fatigue, but still super durable to handle professional manicuring

This ARS 25" Lightweight Hedge Shear has hardened carbon-steel blades with a super-sharp cutting surface that holds its edge. You'll want these shears for professional manicuring and sculpting your shrubs and topiaries.

Item #	Length	Description	Price
220840	25"	Head Shears	\$106.99



CORONA Hedge Shears With Heavy-Duty Aluminum Handle

Light but powerful for sharp cuts

These Corona® Heavy-Duty Aluminum Handle Hedge Shears combine the advantages of forged strength and light weight.

Item #	Blade Length	Length	Price
G48990	8"	24"	\$52.49
G48995	10"	26"	\$54.99



CORONA **Corona Commercial-Grade Professional Loppers**

These loppers are lightweight, extremely durable and have heat-treated forged steel alloy blades that cut effortlessly

Corona Commercial-grade Professional Loppers feature resharpenable and replaceable blades.

Item #	Length	Price
217672	26"	\$74.39
217673	32"	\$76.59



ARS **LongReach™ Loppers**

Revolving arm helps you reach difficult areas

Extra length lets you reach into dense bushes, up high trees and into spots where other loppers won't fit. Revolving aluminum arm gives precise cutting angles.

Item #	Handle Length	FO	Price
230714	5'	■	\$129.99
230715	6'	■	\$134.99

■ Oversize item: additional shipping charges will apply.



Hickon **Vine and Tree Loppers**

30% lighter than many competitors

Aircraft-grade alloy steel heads and aluminum handles makes these loppers up to 30% lighter than competing loppers, without sacrificing precision or strength. Extra-deep hood and curved blade holds limbs firmly in place while you make smooth, professional cuts.

Vine Loppers feature smaller blades than tree loppers and have a 30 degree offset, allowing you to reach straight into the vines.

Item #	Cutting Capacity	Length	Price
217902	1-1/8"	24"	\$59.99
217898	2"		\$74.99
217899	2"		\$79.99
217900	2"		\$84.99



FELCO Lopper

Withstands commercial use

You'll find this lopper is a superior two-handed pruning tool. It has solid, forged light metal handles, replaceable Swiss blades, cushion stops to absorb shock, sap groove on the anvil blade and a fine-blade torque adjustment.

Item #	Cutting Capacity	Length	Price
F22	1-1/2"	33"	\$210.49



FELCO Cam-Assisted Loppers

Reduce fatigue

Get up to 65% more cutting power using the cam-assisted loppers. Each features strong tubular aluminum-alloy handles and high quality steel blades.

Bypass Cutting Head-Ideal for live branches and vines.
Curved Anvil/Hollow-Ground Blades-Ideal for cutting very hard dead wood.

Item #	Blade Style	Cutting Capacity	Length	Price
221880	Bypass	1-5/8"	31-1/2"	\$158.99



BAHCO 31" Heavy-Duty Lopper

The large cutting capacity of this versatile BAHCO professional-grade lopper gets the job done quickly

Whether you're a professional landscaper or homeowner, the BAHCO 31" Heavy-Duty Lopper is just what you need. This powerful, extended-reach bypass lopper cuts up to 2"-dia. branches and vines.

Item #	Cutting Capacity	Length	Price
182065	2"	31"	\$129.99



FELCO Loppers with Straight Cutting Head

Smaller cutting heads--ideal for pruning in tight spaces

Loppers feature Felco's micrometric blade-adjustment system, which ensures optimal cutting-blade adjustment throughout the life of the tool. Aluminum handles are lightweight and incredibly strong.

Item #	Cutting Capacity	Length	Price
221871	1-3/8"	15-3/4"	\$85.99
221872	1-3/8"	19-3/4"	\$94.99
221873	1-3/8"	23-5/8"	\$98.99



FELCO #2 Classic Hand Pruner

This Felco Classic Hand Pruner is just the right size for general-purpose pruning

This Felco #2 Classic Hand Pruner features solid, vinyl-coated, forged metal alloy handles that stand up to the demands of daily pruning. Both the top and bottom blades are held in place with a hardened center nut and bolt to keep the pruner aligned. Weighs 13 oz.

Item #	Length	Cutting Capacity	Price
F2	8-1/2"	1"	\$51.36



FELCO Pruner Replacement Blades

Genuine replacement part to restore your pruner to peak performance

These Felco Pruner Replacement Blades are precision-made Swiss blades built for durability.

Package includes one cutting blade that fits a variety of Felco pruner models: F2, F4, F5, F6, F7, F8, F9, F10, F11, F12, F13, F20, F21, F22 and F31.

Item #	Fits Model	Price
125945	F5	\$15.99
F63	F6, F12	\$16.99
F93	F9, F10	\$17.99
125946	F31	\$18.99
F133	F13	\$19.29
F73	F7, F8	\$19.29
F2B	F2, F4, F11	\$19.29
F233	F20, F21	\$33.99
151123	F22	\$48.79



FELCO Leather Pruner Holster with Metal Belt Clip

Keep your Felco or Corona pruner safely at your side until you need it

This Leather Holster fits any Felco pruners - keeping it handy when on the job. Features a high-tension metal belt clip and slits for belt for versatility.

Item #	Price
F105	\$13.99



Pistol-style Holster w/ Knife Pouch

9" Pistol-style Holster w/ Knife Pouch

Made of durable leather, this 9"L pistol-style pruner holster is made with lock stitched and riveted brown oil-tanned top-grain steer hide leather. Holds pruning tools snug against your side without using straps or snaps and includes a 3"D pocket for a small knife. Also features a 2"W belt loop and nickel-plated hardware.

Item #	Description	Price
108491	10"L Pruner Holster with Knife Pouch	\$11.49
212047	9"L Pistol-Style Holster w/ Knife Pouch	\$12.29
G53112	8"L Shaped Holster w/ Snap	\$17.49
G97220	9"L Pruner Holster w/ Knife Pouch	\$17.99
212045	8"L Pistol-Style Holster	\$8.49
153360	8"L Shaped Holster	\$8.99
212046	9"L Pistol-Style Holster	\$9.99



Replacement Springs for Felco® Pruners

Keep your Felco® pruners ready to go

Pack of two replacement springs for Felco pruners fit the models listed below. See table below for correct replacement springs.

Item #	Fits Model	Price
125947	F5, F11, F13	\$5.99
125948	F6, F12, F160S	\$5.99
125949	F30, F31	\$6.99
F291	F2, F4, F7, F8, F9, F10, etc.	\$6.99



Pruner Replacement Nut and Bolt Set

Replacement Nut and Bolt Set for Felco Pruners

Keep your Felco Pruner in tip-top shape with this Replacement Nut and Bolt Set. Includes center bolt, nut, screw for thumb catch and locking segment.

Item #	Pruner Number	Price
G44290	Felco # F4	\$13.99
G44290	Felco # F2	\$14.49
G44290	Felco # F13	\$14.99



FELCO #4 Basic Hand Pruner

This Felco Basic Hand Pruner is perfect for all-around, general use

The Felco #4 Basic Hand Pruner is similar to the Felco #2 Classic Hand Pruner, only with more basic features. It features solid, vinyl-coated, forged metal alloy handles without a rubber cushion or shock absorber. Both the top and bottom blades are held in place with a hardened center nut and bolt to keep the pruner aligned. Weighs 11 oz.

Item #	Length	Cutting Capacity	Price
F4	8-1/4"	1"	\$47.99



FELCO #5 Low-Priced Hand Pruner

This economical Felco Hand Pruner is a great choice for crews who lose or abuse their pruners

This basic Felco Hand Pruner gets the job done without the bells and whistles. Made with solid steel handles and simplified construction. Weighs 11 oz.

Item #	Length	Cutting Capacity	Price
F5	9"	1"	\$36.99



FELCO #6 Small, Hand-Size Pruner

The small size of this Felco Hand Pruner is perfect for working in your flowers and herbs

The shorter blades of this Felco Small Hand Pruner lets you get in close to plant stems - perfect for pruning grapes, flowers and herbs. Features one-handed thumb catch. Weighs 13 oz.

Item #	Length	Cutting Capacity	Price
F6	7-1/4"	13/16"	\$59.99



FELCO #7 Right-Handed Pruner

This Felco Hand Pruner delivers efficient, comfortable cutting that's just what you need for prolonged use

The Felco #7 Right-Handed Pruner features a bottom handle "swivel action" that requires up to 30% less effort than conventional pruners. Just what you want for big jobs! Weighs 13 oz.

Item #	Length	Cutting Capacity	Left/Right Hand	Price
F7	8-1/4"	1"	Right	\$75.99
F10	8-1/4"	1"	Left	\$80.99



FELCO Ergonomic Pruners

Strong, durable, and well-designed for maximum comfort with little effort

These pruners deliver precise, Swiss-cutting action that leaves clean, effortless cuts. Ergonomically shaped for a comfortable fit you'll appreciate when working on bigger jobs.

Item #	Length	Cutting Capacity	Left/Right Hand	Price
F8	8-1/4"	1"	Right	\$54.99
F9	8-1/4"	1"	Left	\$59.99



FELCO #11 Narrow-Blade Hand Pruner

The narrower, pointed blade works great for close-in pruning

The Felco #11 Hand Pruner has a narrower, pointed blade that makes it easy to cut close to the trunk or branch. Weighs 13 oz.

Item #	Length	Cutting Capacity	Price
F11	8-1/4"	1"	\$59.99



FELCO #13 Extra-Long Handle Hand Pruner

Extra-long handles make it easy to cut thick branches and brush

The Felco #13 Hand Pruner has extra-long handles that provide the added leverage you need when pruning thick branches. Weighs 13 oz.

Item #	Length	Cutting Capacity	Price
F13	10-1/2"	1-3/16"	\$69.99



FELCO Needle Nose Pruner

Trust Felco pruners for efficient harvesting of flowers and fruits

The unique needle nose shape of this Felco pruner makes it well suited for pruning flowers, and harvesting grapes and other fruits. Pruner measures 7-3/4"L and weighs 4 oz.

Item #	Length	Cutting Capacity	Price
125852	7-3/4"	2/5"	\$24.99



ARSD GrowTech Fruit Pruners

Hardened blades are high-carbon steel for very clean and accurate cuts.

Item #	Description	Length	Price
ARS310	Curved-Blade Pruner	6"	\$13.99
ARS340	Short-Blade Pruner	6-3/4"	\$16.99
ARS350	Needlenose Pruner	7-1/2"	\$17.49



ARSD Quality, Low-Cost Pruner

Don't sacrifice quality for economy

Even though this pruner is low cost, it is built with the quality that Japanese tools are known for. High-carbon steel blades are hard-chrome plated for durability. Lightweight aluminum die casting body will not rust and is reinforced with metal to ensure long life. Vinyl coated handles.

Item #	Length	Cutting Capacity	Price
K400	8-1/4"	1"	\$20.99



ARSD Heavy-Duty Hand Pruner

Choose from three different handle lengths and blade sizes to better fit your hand size for reduced hand fatigue and wrist problems

This ergonomic ARS Heavy-Duty Pruner has replaceable, hard-chrome-plated blades for superior sharpness, rust and sap resistance and durability. Replacement blades sold separately.

Item #	Cutting Capacity	Length	Price
171431	1/2"	7"	\$45.99
171432	5/8"	8"	\$49.99
171433	1"	9"	\$56.99



Professional Bypass Pruner

Make close and clean cuts without hurting your hands

This Corona Bypass Pruner is a professional-grade pruner that lets you make clean, close cuts with the 1" cutting capacity. 8 1/2"L. 9.25 oz.

Item #	Length	Cutting Capacity	Price
163823	8-1/2"	1"	\$25.99
163849	8-1/2"	1"	\$35.99



Heavy-Duty, Commercial-Grade Pruner

This Heavy-Duty, Commercial-Grade Pruner cuts branches and brush quickly and with little effort

This Corona Heavy-Duty Commercial-Grade Pruner has forged steel alloy blades that hold a sharp cutting edge - easily cutting branches and brush up to 1" dia. Pruner features an all-steel, self-aligning pivot bolt.

Item #	Length	Cutting Capacity	Price
C316	8-1/2"	3/4"	\$22.99
C318	8-1/2"	1"	\$29.99



Thinning Shear

Clean cuts even in tight spaces

This hard-to-find Corona Thinning Shear has a smooth scissors action for easy, clean cuts, with straight, resharpenable narrow blades that can get into tight spaces easily. Cutting capacity 1/4". 7-3/4"L. 10 oz.

Item #	Length	Cutting Capacity	Price
153371	7-3/4"	1/4"	\$21.99



bond Economical Bypass Pruner

Heat-treated steel blades that stay sharp! Precision-ground blades minimize effort needed for each cut. Internal springs open the blade after each cut to minimize fatigue. Nonslip grip. Safety latch. Includes nylon holster.

Item #	Length	Cutting Capacity	Price
151143	8-1/4"	3/4"	\$10.99



BAHCO Heavy-Duty Professional Pruner

For those who make 5-12,000 cuts per day!

The angled cutting head on this pruner allows your hand to stay in a neutral position for the majority of cuts, reducing muscle and joint strain. Handle made of a light weight fiber glass. One-hand locking mechanism. Replacement parts sold separately.

Item #	Length	Cutting Capacity	Price
182061	8-1/4"	3/4"	\$48.99



Ratcheting Hand Pruner

Make sharp cuts with less effort

All-metal construction with a wraparound knuckle protector and ergonomic handle. SK5 carbon-hardened steel blade cuts through the hardest wood with ease. 3-stage ratching action.

Item #	Description	Price
226704	Sheath	\$19.96
226702	8"L Pruner	\$32.71
226703	Replacement Blade	\$7.48



FELCO All-Purpose Sharpener

Recommended by Felco for sharpening their complete line of pruners and loppers. Concave, composite steel blade. Little pressure required to sharpen the cutting edge.

Item #	Length	Price
127536	3-3/4"	\$28.99



FELCO 980 Tool Spray

This Felco Tool Spray extends the life and performance of your pruning tools

Extend the life and performance of your pruners, shears and cutters with this Felco 980 Tool Spray. Spray removes sap deposits, lubricates blades and protects your pruning tools from rust - perfect for winterizing. 1.89 fl. oz.

NOTE: Cannot be shipped by air.
Note: not for sale in (AL;GA).

Item #	HM	Price
134174	▲	\$14.99

▲ Requires special handling due to DOT regulations. Additional shipping charges will apply. Cannot be shipped by air.



ARS All-Purpose Scissors

ARS All-Purpose Scissors for light, general garden pruning

High-leverage scissors make clean cuts on a variety of materials. Blades are high-carbon steel and hard chrome plated to last for years.

Item #	Length	Price
ARS330	6-1/4"	\$17.79
139420	6-1/2"	\$19.29



ARS GROWTECH Grape Scissors

ARS Grape Scissors are a great all-purpose pruner and are perfect for flower cutting, bonsai or fruit pruning

ARS Grape Scissors feature stainless steel hardened blades leave clean, quick cuts on woody stems. 6" length.

Item #	Length	Price
ARS320	6"	\$23.99



CORONA Floral Shears

Cleanly cut flowers, herbs and other green, non-woody plants with ease

Don't butcher your flower stems with a dull knife or scissors. Serrated, stainless steel blades are heat treated, re-sharpenable and rust resistant. Feature comfortable ergonomic co-molded grips.

Item #	Length	Price
150998	9-3/4"	\$10.79



ARS Telescoping LongReach Razor Edge Pruners

Lightweight, telescopic tree pruner delivers precision pruning at heights normally requiring a ladder

ARS LongReach Razor Edge Pruners have been redesigned to allow easier access in tight spaces. The ZR series had an awkwardly placed tilt-case that was eliminated in this new, ZF series. The inner rod was also strengthened to improve durability. Choose a tool that telescopes from 4-7' in three stops, or 6-10' in five stops. Both versions include drop-forged, Razor Edge blades with nonslip, plastic-coated handles that rotate in the pole. Tools are lightweight and perfectly balanced so they're maneuverable even when they're fully extended. 1/2" cutting capacity.

Item #	FO	Price
229903	■	\$125.99
229904	■	\$134.99

■ Oversize item: additional shipping charges will apply.



ARS Telescoping Longreach Pruners

LongReach Pruners are perfectly balanced, allowing for precise pruning at heights normally requiring a ladder. Inner rod strength for durability. Telescopes from 4' to 7' in three stops, or 6' to 10' in five stops. Drop-forged blades for long-lasting sharpness and durability, chrome-plating for rust and sap protection.

Item #	Description	FO	Price
229901	4'L to 7'L Cut-and-Hold	■	\$134.99
229902	6'L to 10'L Cut-and-Hold	■	\$141.99

■ Oversize item: additional shipping charges will apply.



Professional Tree Trimming High-Limb Chain Saw

Trim branches up to 25' high

Trim hard-to-reach branches from the ground. Toss the throwing weight over the branch, then pull the blade into position. Pull the rope one side at a time to cut the limb with the two-way-action cutting blade. The blade easily cuts through limbs up to 8" dia. Each saw contains a 48"L carbon steel chain saw blade, two 25'L polypropylene control ropes, throwing weight, instruction booklet and vinyl carrying pouch.

Item #	Price
G48900	\$48.99



Silky Hayauchi Pole Saw

Cut higher limbs safely from the ground

This lightweight, durable, Silky Hayauchi Pole Saw cuts limbs with ease. Includes protective sheath. Replacement blade (Item # 220675) sold separately.

Item #	Pole Length	FO	Price
220673	16'	■	\$249.95
220674	21'	■	\$299.99
220675			\$89.99

■ Oversize item: additional shipping charges will apply.



Silky Zubat Extending Pole Saw

The Silky Zubat Pole Saw is made of professional-grade aluminum to reduce weight and provide rigidity while sawing

Because of its light weight and curved blade, the Silky Zubat Extending Pole Saw ideal saw to use while you're on a ladder. Blade scabbard included.

Item #	Length	FO	FT	Price
158856	9'	■		\$154.99
158857	11'	■		\$164.99
158858	13'		*	\$194.99

*Item ships by Truck due to size and weight.

■ Oversize item: additional shipping charges will apply.



Silky LongBoy Pole Saw with XL Teeth

12-foot extension makes trimming those unreachable branches easier than a piece of Aunt Bee's homemade pie

This lightweight aluminum alloy telescoping pole saw makes reaching tall branches a breeze.

Item #	FO	Price
197957	■	\$254.99

■ Oversize item: additional shipping charges will apply.



Silky Replacement Blade for Bigboy Saw

Replacement blade for Bigboy Saw

Replacement 14-1/5"L blade for Silky Bigboy hand saw, .

Item #	Description	Price
197935	Medium Tooth Replacement Blade	\$35.95
197933	Large Tooth Replacement Blade	\$35.99
197937	Fine Tooth Replacement Blade	\$35.99
197939	Curved X-Large Tooth Replacement Blade	\$39.99
197934	Bigboy 360 with medium teeth	\$63.95
197936	Bigboy 360 with fine teeth	\$64.99
158859	Bigboy 360 with Large Teeth	\$64.99
197938	Bigboy 2000 Curved Blade	\$69.99



Silky Zubat 330 Hand Saw

Cut faster with less effort

Features a rust-resistant, hard-chrome-plated blade with an impulse-hardened, non-set tooth design. Taper-ground curved blade provides greater cutting speed with less effort. Four cutting angles to provide base, clean and smooth cutting action. The molded-rubber handle is comfortable and easy to grip. Suitable for all pruning and trimming tasks. Each saw comes with a custom scabbard featuring an exclusive roller at entry point to reduce wear on the teeth.

Item #	Description	Price
197947	Repl. Blade	\$49.99
197946	Saw	\$79.99



Silky KatanaBoy 500 Hand Saw With XL Teeth

Cut large limbs and tree trunks faster than ever

This large, two-handed folding saw is one of the biggest in its class. The 19-13/16" L curved impulse-hardened blade features four teeth per inch and a non-set tooth design for faster cutting of large limbs, even tree trunks. Nonslip, rubberized cushion handle provides a comfortable grip. Comes with hook and loop nylon shoulder bag.

Item #	Price
217693	\$199.99



Silky Hayate Pole Saw with XL Teeth

Get extra reach when cutting high branches

This state-of-the-art, 16.5 in Aluminum Telescopic Max Pole Saw is known as the strongest and fastest telescoping pole saw on the market today. Featuring thick, oval-shaped, aluminum alloy extension poles, providing precise control over the direction of the blade, reducing bending. Razor-sharp, super-aggressive teeth with four cutting angles provide extremely fast cutting action. 3-extension, 4 poles/sections.



GEMPLERS Latex-Coated Work Gloves

Excellent performance with an economical price

According to our field test, these are the best, most durable coated gloves available. Knit material is a soft, yet durable, blend of cotton and polyester that completely conforms to your hand. You may even forget you are wearing gloves! Thick, textured, latex-coated palm and fingers are chemical and water resistant, provide incredible grip, and are designed to fit the natural shape of your hand.

Item #	Size Range	Price
109868	S-XL	\$4.49



6"L Folding Pruning Saw

Keep your Felco Folding Pruning Saw in top cutting condition

Replacement folding saw blade for your Felco Folding Pruning Saw, item number . 6"L.

Need more options?

Item #	Description	Price
125950	Repl. Blade	\$26.99
125850	Folding Saw	\$34.99



7"L Folding Pruning Saw

This Corona Folding Pruning Saw has precision-ground, razor teeth that are sharpened on three sides for superior cutting action. Provides superior cutting to make quick work of landscaping and gardening jobs. Weighs 10 oz.

Item #	Description	Price
C804	Repl. Blade	\$18.89
C704	Saw	\$24.99



Signature Series Pruning Saw

With cleaner cuts, easier strokes and less effort, this ARS pruning saw is sure to be your new favorite tool!

This 13"L, curved-blade ARS Signature Series Pruning Saw has impulse-hardened teeth requiring less effort on your part while giving you easier strokes and cleaner cuts. 15 oz.

Item #	Description	Price
192088	Blade	\$45.99



7-1/2" Folding Pruning Saw

Small in size but big on cutting

Unique JS tooth design is aggressive, but leaves a very clean cut. Developed for cutting live green wood. Non-clogging gullets, saw cuts on the pull stroke. 7-1/2"L blade safely locks in both the open and closed position. 16"L overall.

Item #	Price
109984	\$33.99



Hori-Hori Tool

Ideal all-around landscaping and gardening tool

Multi-purpose stainless steel digging tool will dig, weed, cut, scrape and saw making it an ideal gardening tool that's a must for every gardener and landscaper. Heavy-duty rustproof digging blade is 6 3/4"L nearly 1/8" thick, hardened for durability and fully polished for easy cleanup. Serrated edge is great for sawing through roots and quickly dividing perennials. 25 to 150mm depth markings. Includes vinyl-leather sheath with belt loop.

Item #	Price
228503	\$21.99



Economical Soil Knife with High-Visibility Handle

This handy knife will never leave your side while you're planting and transplanting

Economical Soil Knife with High-Visibility Handle features a nylon sheath with a 4" belt loop.

Item #	Price
212040	\$21.99



Ergonomic 4-Piece Garden Tool Set

Here's the perfect Garden Tool Set for mothers and others.

Tools that feel good in your hands, that help prevent injuries, and make gardening more efficient and fun. Radius grips maximize leverage, minimize hand and wrist stress. Aluminum blades are stronger than steel, and will never rust. Each tool is perfectly balanced, for a neutral, natural feel in your hands. Tested and recommended by the National Home Gardening Club. Set includes a trowel, transplanter, weeder and cultivator.

Item #	Price
231011	\$39.99



NEW

LIFETIME Rotating Composter (80 gallon)

Featuring an 80 gallon (302.8 L) capacity, the Lifetime heavy-duty Compost Tumbler is constructed of UV-protected high-density polyethylene (HDPE) panels. The composter is black with a galvanized steel base, and comes in (1) box. How to Compost DVD is included. 5-year limited warranty.

Item #	FT	Price
193180	*	\$215.00

*Item ships by Truck due to size and weight.



NEW

LIFETIME Double Bin Rotating Composter (100 gallon)

Features two 50-gallon (189.3 L) tumblers, the Lifetime Dual Compost Tumbler is constructed of UV-protected high-density polyethylene (HDPE) panels. 5-year limited warranty.

Item #	FT	Price
193181	*	\$299.99

*Item ships by Truck due to size and weight.



Gard'N Cone™

Protects roses and other plants from extreme temperature changes

This Gard'N Cone is more substantial than standard rose cones having a reinforced hood to allow for water drainage and ventilation. This foam cone is ideal for use in spring and fall when daytime temperatures are consistently below 30°F and also provides sub-zero protection in the winter for your flowers and other plants. The Gard'N Cone also features pockets and holes in the base for drainage and securing to the ground with staples, dirt or rocks. 16"L x 16"W x 18"H.

Item #	Price
221418	\$9.99



Season Starter™ Plant Protectors

Get plants in the ground up to six weeks earlier

These innovative plant protectors give your plants a head start on the growing season by protecting them from early season frost. These season starter plant protectors feature a series of water-filled chambers that slowly freeze before the plant even feels the cold. Each protector has 18 individual cells that hold almost 3 gals. of water to protect plants in temperatures as low as 26°F and shelter them from the wind. Ideal for tomatoes, peppers, early-season cucumbers, melons and other vining plants. 18"H x 17"-dia. Pack of three.

Item #	Price
221416	\$14.49



Overwintering Fabrics

Protect your plants from cold damage with overwintering fabrics

Don't take a chance when winter weather threatens. Reusable fabrics are available in four different weights, depending on the level of protection needed. **1.5-oz. Supreme** -Lengthens harvesting time and extends flowering season for flowering annuals, bedding plants and vegetables. Protects vegetation from cold temperatures and light frost. Temperatures underneath the fabric are up to 6° to 8°F warmer than outside conditions. Approximate 50% light transmission.

Item #	Width	FO	Price
215082	7'		\$162.99
215082	10'	■	\$233.99
215082	12'	■	\$297.69

■ Oversize item: additional shipping charges will apply.



Trellis System for Climbing Plants

Create multiple configurations—walls, square or triangular cages

These innovative trellis panels easily hook together to make a variety of configurations—just link, stake and grow! These trellis panels optimize growing conditions and yields by increasing light penetration and air movement in your plants. Bottom stakes can be pressed into the soil up to 12"D. These trellis' are made of heavy-duty, long-lasting 3/16-ga. galvanized wire and measure 20"W x 66"H. Sold in packages of four panels. Select mesh size from the drop-down menu above.

Item #	Height	FO	Price
226167	12"	■	\$54.99
226165	6"	■	\$59.99

■ Oversize item: additional shipping charges will apply.



TEINAX Hortonova Plant Supports

Versatile Hortonova plant support ideal for growing vegetables, fruits and flowers efficiently and economically

This versatile Hortonova plant support is ideal for growing vegetables, fruits and flowers efficiently and economically.

Item #	Width	Price
212542	36"	\$49.99
212543	42"	\$54.99
212544	48"	\$59.99
212545	59"	\$69.99
212546	67"	\$74.99
212547	79"	\$84.99



Powered Wheelbarrows

Self-propelled power to move more, easier

Move materials faster and easier than standard wheelbarrows and work in areas where you can't get a skid steer. Powerful Peerless Transaxle 3 Fwd./1 Rev. speed transmission is ideal for the construction, landscape and agricultural industries. Four-wheel drive units transfer materials up grades as steep as 30 degrees, and narrow design allows them to fit through doors and around tight corners. Feature Honda GXV 5.5-HP (160cc) engines, steel buckets and accept a variety of accessories (sold separately) for multipurpose use.

Item #	Width	Length	Load Capacity	Height	Capacity	FT	Price
167955	28"	61"	550 lb.	34"	6 cu. ft.	*	\$3,999.00
167956	28"	63"	800 lb.	34"	8 cu. ft.	*	\$4,379.00

*Item ships by Truck due to size and weight.



Accessories

Flatbed-Ideal for awkward loads like pots, pavers, bricks or bags of sand, cement or compost. 550-lb capacity. 26-5/8"L x 26-5/8"H.

Snowplow-Can be raised and angled for easier maneuvering. Moves snow or slurry and can even be used for light grading.

Ball-Hitch-Easily attaches to the bucket and allows you to move trailers up to 1.5 tons. Includes 2"-dia. ball.

Bucket Extension-11-13/16"H and increases the bucket capacity by 30%. Attach easily to the bucket. Ideal for compost, manure or mulch.

Loading Ramp-Safely dump material into trucks or dumpsters. 2'W x 5'L sections that one person can quickly assemble. Folds flat. 59-13/16"L x 24"W x 30-9/16"H.

Item #	Description	FO	FT	Price
167959	Power Dumper Tow Hitch			\$149.99
167960	Bucket Extension	■		\$224.99
167957	Power Dumper Flat Bed	■		\$399.99
167962	Loading Ramp		*	\$889.00
167958	48" Wide Snow Plow	■		\$899.00

*Item ships by Truck due to size and weight.

■Oversize item: additional shipping charges will apply.

Need more info? Visit gemplers.com or call 800-382-8473 for product details.



Professional-Grade Wheelbarrows

Take on the tough loads

High-quality components and construction mean these wheelbarrows will keep working hard for you—long! Features varnished American hardwood handles, a heavy-duty, powder-coated nosepiece, front blade, rear chasis and rear stabilizing plate. Choose from extra-thick, UV-stabilized, high-density polyethylene or 17-ga. steel pan styles with recessed bolts for easier shoveling. Choose from a two-ply, 6\"/>

Item #	Pan Capacity	Pan Material	Tire Style	Price
Single Tire Wheelbarrows				
218033	6 cu. ft.	HDPE	6\"/>	

1. Shipped via truck due to size and weight.

Item #	Pan Capacity	Pan Material	Tire Style	Price
Dual Tire Wheelbarrows				
221374	6 cu. ft.	HDPE	6\"/>	

2. Shipped via truck due to size and weight.



Jackson 6-cu ft. Steel Wheelbarrow

This Jackson 6-cu ft. Steel Wheelbarrow let you move materials quickly without the high price tag

Move materials quickly without the high price tag. This wheelbarrow with a 6-cu. ft.- capacity seamless steel pan is an excellent , economical choice for hauling loads on the worksite. Features front braces, a rear "H" brace with cross strips and leg stabilizers. Providing four times more tip resistance. 16" flat-free rib tire with ball bearings for long life. Includes wooden handles and grips.

Item #	Pan/Cart Capacity	FO	Price
221667	6 cu. ft.	■	\$199.99

■ Oversize item: additional shipping charges will apply.



Jackson 6 cu. ft. Folded-steel Wheelbarrow

Strong enough to tackle the toughest landscaping jobs

This Jackson Folded-Steel Wheelbarrow is stronger than regular seamless steel and holds up to 6 cu. ft. of material. Supported with front tray braces, a rear "H" brace with cross strips and leg stabilizers. 16" dia. tube-type, rib-tread tire and wheels with ball bearings for long life.

Item #	Bed Material	Pan/Cart Capacity	Tire Style	FT	Price
221670	Steel	6 cu. ft.	Pneumatic	*	\$219.99

*Item ships by Truck due to size and weight.



Jackson Poly Wheelbarrow

Economical wheelbarrow with rustproof pan

The corrosion-resistant pan of this Poly Wheelbarrow stands up to the elements year-round, rain or shine. The pan is built with heavy-duty, vacuum-formed poly material and has a 5.75 cu. ft. capacity. This wheelbarrow features front tray braces, a rear "H" brace with cross strips and leg stabilizers. Rolls on a 16"-dia. tube-type rib-tread tire, and the wheels feature oil lube bearings for long life. Wooden handles.

Item #	Bed Material	Pan/Cart Capacity	Tire Style	FT	Price
221665	Poly	5.75 cu. ft.	Pneumatic	*	\$229.99

*Item ships by Truck due to size and weight.



Metal Nursery Wagon with Folding Sides

This super-strong metal deck wagon features removable sides, making it perfect for carrying heavy loads at nurseries and garden centers

This wagon is a favorite at retail nursery and garden centers, with a heavy-duty construction ideal for moving all kinds of materials up to 800 lb. Automotive-style anti-tip steering provides optimal stability when turning by keeping the wheels at the edge of the wagon. 48"L x 24"W powder coated, smooth metal deck is diamond punched to allow water, dirt and chips to fall through. 13x5.00-6 pneumatic tires that maneuver over gravel and hoses like a pro. Sides fold down for easy loading and unloading, or can be removed for flat bed use.

NOTE: Some assembly required.

Item #	Load Capacity	FO	Price
167751	800 lb.	■	\$179.99

■ Oversize item: additional shipping charges will apply.



Industrial-Grade, Multi-Purpose Retail Nursery Wagon

This heavy-duty metal deck wagon is super strong, making it ideal for carrying heavy loads at nurseries and garden centers

This wagon is a favorite at retail nursery and garden centers, with a heavy-duty construction ideal for moving all kinds of materials up to 800 lb. Customers use this versatile cart to move purchases while workers use it to move plants, soil, pots and more. Automotive-style anti-tip steering provides optimal stability when turning by keeping the wheels at the edge of the wagon. 38"L x 20"W powder coated, smooth metal deck is diamond punched to allow water, dirt and chips to fall through.

Item #	Load Capacity	FO	Price
167750	800 lb.	■	\$128.99

■ Oversize item: additional shipping charges will apply.



Poly Deck Nursery Wagon

This Poly Deck Wagon is incredibly strong and rust-resistant - you'll never want another wagon

This economical wagon has a 40"L x 20"W polypropylene deck that's extremely strong and will never rust - perfect for nurseries and greenhouses. Automotive-style anti-tip steering provides optimal stability when turning by keeping the wheels at the edge of the wagon. Features four 4.10 x 3.50 pneumatic tires that maneuver over gravel and hoses like a pro. 300-lb. load capacity.

NOTE: Some assembly required.

Item #	Load Capacity	Price
167749	300 lb.	\$99.99



Build-Your-Own Nursery Cart or Wagon

Custom build your own cart or wagon to your exact needs

Add a platform or wagon top to this heavy-duty pneumatic wheel assembly to build a cart or wagon specifically for your application. Kit includes four 10" wheels (4.10/3.50-4 pneumatic tires), one 30" plastic arm pull, two axels and mounting brackets. Attach a 24" x 48" plywood deck (not included) for a heavy-duty nursery cart. Or, get creative and add sides (not included) Kit includes: 4-pneumatic tires, 30"L plastic arm pull, 2 axles, mounting brackets.

NOTE: Decking not included.

Item #	Load Capacity	Price
G44500	1,000 lb.	\$99.99



Landscape Hand Trucks

Take a load off!

Easily move containerized plants, rocks, pavers and timbers. Feature: large platforms, welded grid bodies, fully enclosed 1" dia. solid steel axles with grease fittings and 16 x 6.5-8 high flotation tires.

Item #	Width	Load Capacity	Depth	Height	Platform Size	FT	Price
167820	34"	1,200 lb.	21"	61"	24" x 21"	*	\$459.99
167821	45"	1,600 lb.	21"	61"	35" x 21"	*	\$596.99

*Item ships by Truck due to size and weight.



Nursery Ball Cart

Safely roll trees with root balls up to 32" dia. where you need them

Ball and burlap lift-type cart handles root balls up to 32" dia. Frame is made of 1-1/8", 14-ga. continuous steel tubing and covered with an all-weather, high gloss polymer coating. Triple-reinforced lip reduces root ball slippage and trunk damage. Features a fully enclosed 1" solid steel axle with grease fittings, tow/lifting loop and 16x6.50-8 high-flotation tires.

Item #	Width	Load Capacity	Depth	Height	FT	Price
167819	34"	1,200 lb.	23"	61"	*	\$389.99

*Item ships by Truck due to size and weight.



Haul and Dump Cart

Easy to load; easier to use than a wheelbarrow

Easily hauls up to 1,200 lb. When you've reached your destination, just pull the release handle and easily dump all the contents. 500-lb. dumping capacity. Poly tub is easy to clean, lighter than steel and will never rust. Cart offers a stable hauling platform with four 13" pneumatic turf tires that roll easily over a variety of terrains. Easily pull the cart with lawn tractor, ATV or utility vehicle; just convert the unique, dual-purpose handle from a D-grip pull handle into a trailer hitch tongue by simply removing two pins. Tub is 40"L x 25-1/2"W x 10"H.

Item #	Load Capacity	FO	Price
212535	1,200 lb.	■	\$173.99



Tandem-Axle Dump Trailers

Make hauling heavy loads a little bit easier

Tandem Walking Arm™ dual-axle dump cart helps balance big loads while providing stability and smoothness over rough terrain. Features a pass-through axle design for extra clearance plus sealed ball bearings. Rugged, high density polyethylene body that's great for hauling rocks, firewood, gear and more. All-steel, tilt and pivot frame is powder coated and features a quick-release tipper latch. 18 x 8.50 wide track trailer tires.

Item #	Load Capacity	FT	Price
227672	1,200 lb.	*	\$639.99
227673	1,500 lb.	*	\$679.99

*Item ships by Truck due to size and weight.



EarthWay Electric Spreader with Remote Gate Control

Ideal for ATVs and utility vehicles

Innovative EarthWay electric spreader features a stainless steel control box with an Electronic Control Module®, that lets you turn on the motor, open the flow gate and start spreading without having to use ropes or cables. The Ev-N-Spred®, dual-port shut-off system also allows you to balance the material flow to the right and left side evenly regardless of material density. 12V motor is mounter inside the hopper and encased in a high-impact, thermoplastic case. Chassis is constructed from heavy-duty stainless steel and features an integrated vertical or horizontal mounting system that allows you to bolt the unit in the bed of a utility vehicle or against any solid



EarthWay Hand Crank Broadcast Spreaders

Accurate and Precise

Nylon BagSpreads granular materials in wet or rough areas a push spreader can't go. Great for quicker jobs.

Poly HopperAdjustable shutoff system allows for balancing the spread pattern. Spreads up to 15'W. Super-duty high speed gear box.

Item #	Description	Hopper Capacity	Price
227682	Poly Hopper	40 lb.	\$141.79
G42700	Nylon Bag Hopper	20 lb.	\$61.99



EarthWay Commercial Series Broadcast Spreader

Super-duty gearboxes have enlosed gears for years of trouble free use. Hoppers are attached to frames with a 175-lb. load bearing capacity. Solid direct-connect linkage gives accurate flow control. Includes a nylon shut-off plate and hopper screen. Rolls easily on large 13"-dia. pneumatic stud tires.

Item #	Hopper Capacity	Hopper Volume	Price
G45551	50 lb.	1,325 cu. in.	\$229.99
45550	100 lb.	3,350 cu. in.	\$259.99



EarthWay 80-lb. Broadcast Spreaders

These spreaders make it more economical to have one spreader for every chemical. Commercial gearbox is fully enclosed for long life and protection. Large 10" pneumatic wheels help with rolling over rough lawns. Comes fully assembled with a full sized folding handle for instant setup and immediate use.

Item #	Description	Hopper Capacity	Hopper Volume	Price
61049	Trailer Spreader	80 lb.	1,900 cu. in.	\$136.49
106231	Push Spreader	80 lb.	1,900 cu. in.	\$143.99



EarthWay Ice Melt Broadcast Spreader

Quickly melt ice over large areas

Spreads ice melt, rock salt, dry sand and other high volume products. Out performs other spreaders of its size and price with true commercial features at an affordable cost. Features a 65-lb. capacity, rustproof poly hopper, solid linkage control to reliably open/close hopper and an epoxy-coated chassis that stands up to we snow and ice 9" pneumatic tires tackle tough terrain.

Item #	Hopper Capacity	Price
210506	65 lb.	\$146.99



EarthWay Broadcast ATV Spreader

Excellent choice for mid-sized jobs that are too big for a push spreader

This EarthWay broadcast spreader is a great choice for mid-sized jobs that are just a little too large for a push spreader. The spreader lets you quickly spread seed, chemicals and more and the quick-connect, horizontal-mount system mounts the spreader to the front or rear luggage rack of your ATV. Built-in 12V motor has a vinyl coating and the chassis has an epoxy coating for long life. Lever and gauge mount on either side for easy access. Wiring harness and rain cover included. 80-lb. hopper capacity. Weighs 11 lb.

Item #	Hopper Capacity	Price
G46887	80 lb.	\$225.79



12V Variable-Width ATV Spreader

This Fimco ATV spreader uses a variable-speed 12V motor (with on/off switch) that lets you change the spread width from 5' to 45'W - making it ideal for covering turf, parking lots, sidewalks and other odd-shaped areas. Spreader features a tough, corrosion-resistant 2.2 cu. ft. poly hopper and includes controller, wiring harness, mounting brackets and hardware. 110-lb. hopper capacity. 150-lb. load-bearing capacity. Frame and universal ATV mounting brackets are constructed from steel an d powder coated to prevent rust.

Item #	Hopper Capacity	FO	Price
167711	110 lb.	■	\$429.99

■ Oversize item: additional shipping charges will apply.



solo® Portable Spreader

Carry up to 20 lb. of seed, fertilizer, pelletized materials, sand or ice melter in this durable Solo portable spreader

Precision flow control, directional spreading and a durable gear drive system make this spreader ideal for professionals. Built in agitator, adjustable for both direction and volume with fingertip controls. Large opening for easy filling. Ruffed, reinforced polyethylene materials prevent rust and clogging.

Item #	Hopper Capacity	Price
G44421	20 lb.	\$58.99



SNOWEX ✓ 28\"/>

Perfect for sidewalks, driveways and walkways

This SnowEx Drop Spreader is a heavy-duty spreader that accurately spreads rock salt and pelletized deicers in a 28" width making it ideal for sidewalks and other walkways. Designed with fewer moving parts than competitor models, this spreader features a high-impact, low-density polyethylene hopper and a powder-coated frame for long life. The large hopper handles up to 100 lb. of material and has a 10-ga. wire grid to break up clumps. Includes clear hopper rain cover and 13-5.00-6 pneumatic tires. 55 lb. empty.

Item #	Hopper Capacity	FT	Price
171281	160 lb.	*	\$734.40

*Item ships by Truck due to size and weight.



SaltDogg Salt Spreader

SaltDogg Salt Spreader is extremely durable for professional applications, but isn't overkill for using at home

The SaltDogg Salt Spreader features a fully welded, powder-coated steel frame and stainless steel gears - making it super durable for professional use. Spreader also features a steel hopper screen, three-flap adjustable poly deflector and flow regulator with solid control linkage for nice, even application.

NOTE: Not for use with sand.

Item #	Hopper Capacity	Price
224019	100 lb.	\$249.99



V-style Acreage Rakes

Rake, dethatch, gather cut grass and leaves and put them into a neat windrow for easy pick up with a lawn sweeper. The tine reels on this V-style Acreage Rake feature built-in bearings.

Features heavy-duty 1" steel tube frame with a pin-style hitch and 12" pneumatic tires. Shipped by motor freight.

Item #	FO	Price
215197	■	\$309.99
215198	■	\$399.99

■ Oversize item: additional shipping charges will apply.



SNOWEX Rotary Broom Sweeper with Plow

Make large snow-clearing jobs easier than ever

This SnowEx Rotary Broom Sweeper with Plow makes large snow-clearing jobs easier than ever. A brush cover helps reduce unnecessary wear and tear.

Item #	Width	FT	Price
226781	40"	*	\$4,449.60

*Item ships by Truck due to size and weight.



SNOWEX Broadcast Spreader

The versatile SnowEx Broadcast Spreader is built for long life with fewer moving parts than most other spreaders

High quality spreader designed for professional use with deicers, including rock salt, pelletized materials and dry sand. Designed for long life with fewer moving parts than competitor models; high-impact, low-density polyethylene hoppers, powder-coated frames and a custom engineered transmission to take on snowy, icy surfaces like a champ. Features a 10" molded plastic spinner with agitator and a 10-ga. wire grid to break up clumps of material. Spreader includes a deflector kit and clear hopper cover and 13 x 5.00-6 pneumatic tires. Spreads up to 20'W. Weighs 42 lb. empty.

Item #	Hopper Capacity	FT	Price
171280	160 lb.	*	\$549.99



SNOWEX 3 CU. FT., 12V Wireless Rock Salt Spreader

Hook up this economical winter deicing solution and beat the ice with wireless control

Features a patented 12V electric sealed drive/transmission that spreads chunky rock salt up to 25' away. Just attach to any vehicle with a 2" receiver and a standard seven-pin trailer plug, and you're ready to go. Wireless key fob features on/off and two preset spinner speeds. 10" glass-reinforced nylon spinner and 3" vertical high-flow auger keeps the salt flowing. Weighs 68 lb. empty. 22"L x 30"W x 32"H.

Item #	Description	FO	Price
212969	Cover		\$42.99
212967	Rock Salt Spreader	■	\$795.60

■ Oversize item: additional shipping charges will apply.



Heavy-Duty Steel Lawn Rollers

This Heavy-Duty Steel Lawn Roller gives your lawn a smooth, even appearance

Give your lawn a smooth, professionally groomed appearance by packing uneven ground caused by mole damage or frost heaving. Ideal for packing newly sown seed or sod. Sand may also be used instead of water. Both models feature a durable powder coat finish, an expansion drain plug for a tight seal and rounded edges for easy turning.

NOTE: Item No. 147736 and 167793 are shipped by motor freight. Charges to be determined when order is placed.

Item #	Landscape & Nursery: Size	FT	Price
106240	36"W x 18"D	*	\$199.99
147736	48"W x 24"D	*	\$274.99
167793	60"W x 24"D	*	\$397.99

*Item ships by Truck due to size and weight.



Heavy-Duty Lawn Sweeper

Pull this Ohio Steel Lawn Sweeper behind your ATV or lawn tractor for quick cleanup of commercial landscapes or large lawns

Lawn sweepers are huge time savers when it comes to removing grass clippings and leaves from turf. Ground-driven and may be pulled with an ATV or lawn tractor. Feature a "no-slip" brush height adjustment, a multi-position clevis drawbar that fits a variety of vehicle hitches from 6"H to 11"H, and sealed ball bearings for long life. 11" spiral brushes pick up debris better than traditional brushes. 11" tires. Collection bag flips up when not in use for easy storage.

Item #	FO	Price
167794	■	\$369.99

■ Oversize item: additional shipping charges will apply.



Heavy-Duty, Pull-Type Aerator

This TurfVent Pull-Type Plug Aerator is designed for professional grounds maintenance - giving you heavy-duty quality for everyday use

Plug aerators for professional grounds maintenance provide heavy-duty quality for everyday use. Available in three widths in either pull-type or three-point hitch versions. All units produce 45 core plugs per square yard that are 5/8" dia. with a maximum 3-1/2" soil penetration. Replacement tine clusters turn independently so they don't tear the turf while making turns and include grease fittings for long life. Include galvanized 4.10/3.50-4 pneumatic transport tires. Three-point hitch units include hardware to make compatible with Category 0, 1, and Category 1-limited three-point hitches.

Item #	Width	FO	FT	Price
147643	32"	■		\$599.99
147644	40"		*	\$675.99
147645	48"	■		\$759.99

*Item ships by Truck due to size and weight.

■ Oversize item: additional shipping charges will apply.



SWEEP EX **SSM-480 Replacement Brick/Paver Brush for 48"W Rotary Broom**

SweepEx replacement Brick and Paver Brush for 48"W rotary broom (Item #).

Item #	Description	FO	Price
226767	Winter Tire		\$299.99
226772	SRS-480 Replacement Snow Brush	■	\$374.17
226777	SSD-480 Replacement Dirt Brush	■	\$374.17
226779	SSM-480 Replacement Brick/Paver Brush	■	\$419.08
226775	SMP-480 Replacement Standard Brush Kit	■	\$424.99
226770	Leaf Collector	■	\$450.00
226764	Debris Collector	■	\$629.10

■ Oversize item: additional shipping charges will apply.



NEW

DEWALT **20V Brushless Blower with 5AH Pack**

Clear debris with an air volume of up to 400 cubic feet per minute at 90 miles per hour. With an ergonomic and extremely lightweight design, the blower is easy to control and minimizes stress on the arm. The variable speed trigger and speed lock give the user full power control.

Note: not for sale in (AL;GA).

Item #	HM	Price
DCBL720P1	▲	\$199.00

▲ Requires special handling due to DOT regulations. Additional shipping charges will apply. Cannot be shipped by air.



KINCO **18-oz. Heavyweight Chore Gloves**

These work gloves are made of a heavyweight, breathable chore material with an angled wing thumb design, which is seamless between palm and thumb, that adds flexibility and comfort. Snug-fitting knit wrist keeps out debris, while holding in warmth.

Item #	Size Range	Price
139515	M-2XL	\$5.99



Fertilizer Density Scale

Fertilizer Density Scale is easy to read and simple to use

Portable, accurate scales made of chemical-resistant ABS plastic. Use grain scale to determine test weight of different varieties of grain or measure bin capacities and feed quality. Hang scale from stainless look and slide counterweight unit level. Fertilizer scale helps you set fertilizer application equipment to the correct weight per cubic foot. Metric or standard weights. 15-1/2"L. USDA Approved.

Item #	Description	Price
AGS	Grain Scale	\$56.99
FDS	Fertilizer Scale	\$58.99



Digital Tabletop Scales

Compact and accurate scale for seeds, postage and small packages

Loaded with efficient features that are ideal for weighing soil, seed, samples, postage, small packages, parts counting and more. Read in grams and ounces and have push-button tare. All models may be operated on optional AC adapter (not included). Features one-touch tare, easy to read LCD display and stability. Low profile and easy to store.

NOTE: Cannot be shipped to U.S. Territories.

Item #	Capacity	Price
154849	4.4 lb./2,000g	\$189.99
154851	11 lb./5,000g	\$229.99
154852	26 lb./12kg	\$229.99
126401	7.05 oz./200g	\$95.99
126402	70.5 oz./2,000g	\$95.99



Digital Package Scales

The Ohaus SD Series shipping scale is loaded with features to handle a wide variety of weighing and parts counting tasks quickly and reliably. Weighs in pounds and kilograms and is ideal for office, mail room, shipping and receiving, as well as general commercial and industrial weighing applications. Scale features a corded four-digit digital readout that can be placed up to 9' from scale for easy, convenient reading. Base measures 12.4"L x 11"W x 1.8"H with 12.4"L x 11"W. AC adapter included.

Item #	Capacity	Price
141262	77 lb./35kg	\$179.99
141263	165 lb./75kg	\$184.99
141264	440 lb./200kg	\$219.49



Polypropylene Scoops

Scoops have no seams or cracks for bacteria to grow

These scoops make quick work of moving all different types of bulk materials from feed to fertilizer. Scoops never rust or corrode. Plus, they're non-sparking and autoclavable. FDA-compliant.

Item #	Width	Length	Volume Capacity	Price
221980	9"	11"	128 oz.	\$15.49
221973	3-1/2"	10-1/4"	16 oz.	\$5.49
221978	5"	11-1/2"	32 oz.	\$6.49
221979	6-1/2"	15"	82 oz.	\$7.99



TeeJet CenterLine 200 GPS Lightbar Guidance System

Reap the benefits of GPS lightbar guidance at a foam marker price

This TeeJet CenterLine 200 is a compact, portable GPS unit that comes complete with everything you need to save time, money and materials. The unit includes a power outlet cable, digital display, GPS antenna with 16' L cable and suction cup mounting bracket for quick and easy set-up.

Item #	Price
147630	\$1,099.00



TAYLOR Mechanical Hanging Scales

Easily weigh fish, game, feed or packages

This Taylor Mechanical Hanging Scale is just what you need to accurately weigh feed, fish, game or packages. Simply hook it up to easily weigh up to 70 lbs., even when there's no flat surface available. It boasts an accuracy of +/- 1% and reads in 5-lb. increments. Scale measures 14"L x 4"W. 280 lb. capacity. Not legal for trade.

Item #	Price
198639	\$20.29



Metal Storage Rack for Handheld Weed Trimmer/Hedge Clipper

Keep your awkward-sized tools like weed or hedge trimmers off the ground and securely stored

This Metal Storage Rack for Handheld Weed Trimmer/Hedge Clipper is great for storing awkward-sized tools like weed or hedge trimmers which can be difficult to store safely and securely. The 20-ga., cold-rolled steel trimmer rack keeps long, gas-powered tools off the ground and in a vertical position. Weighs 4.5 lb.

Item #	Price
151069	\$37.39



ROPS Trimmer Rack

Keep your string trimmer handy at all times

All in one design quickly mounts to your mower's ROPS with simple U-clamps. No holes or separate pieces to drill. Quick Fist rubber clamp adds extra tight security and a 5 inch extension (included) if you need extra clearance. Includes ROPS Trimmer Rack, two clamps, extension and heavy duty twist wrap. Made to fit Echo, Stihl and all major brand trimmer and edgers.

NOTE: Will fit a 2x2 or 2X3 ROPS bar.

Item #	Price
225050	\$119.99



Sprinkler Head Trimmer

Maximize the efficiency of your in-ground sprinkler

This Midwest Rake Sprinkler Head Trimmer is ideal for golf courses, athletic fields and large lawns where utilizing the full watering capacity of your sprinkler heads is vital to turf health. Features a step plate which allows for easy trimming.

Item #	Blade Dia.	Price
171632	2-3/4"	\$42.99
171629	3-1/2"	\$43.99
171630	4"	\$44.99
171631	6"	\$59.99



GEMPLER'S Grass Shield, 1 gal.

Mower deck coating keep grass from sticking so you don't have to waste time scraping

Gempler's Grass Shield eliminates one of lawn care's colossal headaches. This colorless silicone mower deck coating leaves a thin, slippery layer that repels freshly cut grass. Apply it to the underside of your lawnmower deck and even the blades themselves. One-gallon container.

NOTE: Complete application directions found on product label.

Note: not for sale in (AL;GA).

Item #	HM	Price
230523	▲	\$34.99

▲ Requires special handling due to DOT regulations. Additional



BRUSHGRUBBER Xtreme

Use your ATV, UTV or light utility tractor to quickly and easily remove trees and brush up to 5" dia. Two large handles welded to the jaws make attaching and removing the unit easy. Ideal for permanently removing buckthorn and prickly ash. 23 lb.

Note: For use with compact tractors under 45 HP, ATVs or UTVs.

Item #	Description	Removes Trees Up To	No. of Gripping Teeth	Thickness	Price
163095	Xtreme	5" dia.	18	1"	\$119.99



BRUSHGRUBBER HD

Use your lawn tractor, ATV or light utility tractor to easily remove trees and brush up to 4" dia. with the Brush Grubber HD. 12.25 lb.

NOTE: Not for use with tractors over 30 HP.

Item #	Removes Trees Up To	No. of Gripping Teeth	Thickness	Price
159984	4" dia.	16	3/4"	\$79.99



AERVOE Red Paint for Tree and Log Marking

Hi-visibility red paint is ideal for marking wood

This long-lasting, fast-drying paint meets all marking requirements of the forestry industry. Aervoe paint is heavily pigmented to provide bright visual identification at long distances. Ideal for inventory and lumber identification, as well as marking of cut wood, trees, logs, railroad ties and pulpwood. Red color. 12-oz. aerosol can.

Note: not for sale in (AL;GA).

Item #	Color	HM	Price
232400	Red	▲	\$4.99
232405	Orange	▲	\$4.99
232420	Blue	▲	\$4.99
232429	Fluorescent Red-Orange	▲	\$4.99
84313	Fluorescent Pink	▲	\$4.99

▲ Requires special handling due to DOT regulations. Additional shipping charges will apply. Cannot be shipped by air.



TIMBER TUFF Spring-Loaded Skidding Tong

These Innovative Spring-Loaded Logging Tong are ideal for pulling logs and poles

Unlike other log skidding tong, these innovative logging tong feature a tension spring to always maintain a secure grip on the log.

Item #	Log Size	Price
201227	22"	\$69.99
201228	28"	\$89.99



ELVEX ProGuard™ Woodsman's Helmet with Nylon Mesh Visor

Dielectric protection for use in areas where you may come into contact with electrical lines. Includes the Tectra award-winning safety helmet from Elvex, medium-profile earmuffs, nylon screen face shields and visor bracket. Black nylon mesh. Meets ANSI Z89.1-2009, Type 1, Class E, G, and C. 6-point ratchet suspension.

Item #	NRR	Suspension	Price
214359	24dB	Pinlock	\$40.99
145642	25dB	Ratchet	\$43.99
165560	27dB	Ratchet	\$51.99



ELVEX ProGuard™ Ventilated Helmet with Steel Mesh Visor

Elvex ProGuard Ventilated Woodsman's Helmet with Steel Mesh Visor gives you an integrated protection system for your head, face and hearing

A uniquely integrated protection system for your head, face and hearing. This Elvex ProGuard Ventilated Woodsman's Helmet is just what you need for outdoor jobs where no electrical hazards exist. Visor bracket included. Meets ANSI Z89.1-2009 Type I Class C requirements. The hearing protection is tested in accordance with ANSI S3.19-1974.

Item #	NRR	Suspension	Price
187153	25dB	Pinlock	\$40.99
187151	25dB	Ratchet	\$42.99
187152	27dB	Ratchet	\$46.99



ELVEX ProGuard™ Woodsman's Helmet with Lexan™ Shield

Elvex ProGuard Woodsman's Helmet with Lexan™ Shield plus 25 dB NRR

This Elvex ProGuard Woodsman's Helmet is ideal when using chain saws and other power tools that might throw debris in your face. Available in a dielectric model (to be worn where the user may come in contact with electric lines) or ventilated model (may be used in outdoor situations where no electrical hazards exist). Features a 6-point ratchet suspension safety cap and nylon webbing. Earmuffs have a 25dB NRR. NOTE: ANSI Z87 requires separate eye protection, suitable to the situation, in addition to a face shield.

Item #	Dielectric	Venting	Price
214356	No	Vented	\$45.99
214355	Yes	Non-Vented	\$45.99



ELVEX AirSpecs™ Steel Mesh Chain Saw Goggles

Protect your eyes when cutting wood

The Elvex AirSpecs Steel Mesh Chain Saw Goggles feature steel mesh "lenses" that protect your eyes from pokes and large debris, while allowing air to pass through. EVA closed-cell foam provides a comfortable face seal. Meet ANSI Z87.1 for basic impact (1" ball-drop) protection.

Item #	Price
225449	\$9.79



NEW

DEWALT 20V Max Compact Chainsaw

This battery-powered chainsaw is built to handle tough construction and outdoor work. The lightweight design maximizes user control. Its brushless motor technology delivers extreme runtime and long motor life. Kit includes a 5.0Ah 20V MAX* battery, charger, and a hard bar cover. Note: not for sale in (AL,GA).

Item #	HM	Price
DCCS620P1	▲	\$229.00

▲ Requires special handling due to DOT regulations. Additional shipping charges will apply. Cannot be shipped by air.



TIMBER TUFF

Bench and Wall-mount Saw Chain Sharpener

Sharpen just about any saw chain easily and quickly
The Timber Tuff Bench and Wall-mount Saw Chain Sharpener sharpens saw chains from 1/4" to 3/4" pitch. This sharpener mounts on a bench or wall for convenience and includes a work light for added visibility while sharpening. Large, easy-to-use knobs allow you to adjust the grinding angle and depth. This sharpener features a 3,600 rpm, 110V, 60-Hz motor and includes 1/8", 3/16" and 1/4" grinding wheels. 16.8 lb.

Item #	Price
163099	\$159.99



TIMBER TUFF

Handheld Chain Saw Sharpener

Portable, battery-operated sharpening without removing the chain

This lightweight Timber Tuff 9.6V handheld chain saw sharpener is small enough to go in the field with you to sharpen chains on the spot and keep safety and efficiency at their peak. This sharpener features 10 variable speeds and runs at 8,000–20,000 rpm. Includes two 9.6V Ni-Cd rechargeable batteries so you'll always have a spare ready to go. This sharpener comes with a 3-hr. AC battery charger and sharpening attachment with LED light for work in low-light conditions, plus 5/32, 3/16" and 7/32" grinding stones. Replacement stones sold separately.

Item #	Price
192052	\$48.99



TIMBER TUFF

Grinding Stones (5-pk.)

Replacement grinding stones for chain sharpeners
Timber Tuff Grinding Stones are replacement stones for the 12V Saw Chain Sharpener, and 9.6V Handheld Saw Chain Sharpener. Pack of 5. Specify Diameter.

Item #	Diameter	Price
163141	5/32"	\$5.79
163140	3/16"	\$5.99
163142	7/32"	\$5.99



ELVEX ProChapsZ™ Chain Saw Chaps

These Elvex ProChapsZ Chain Saw Chaps add an extra layer of safety by reducing the number of catch points where branches or other items can pull or snag

Elvex ProChapsZ Chain Saw Chaps are made with durable, 1,000-denier fabric with a Cordura® nylon outer and features Prolar™ padding that effectively jams chain to quickly stop cutting action. Full wraparound calf with patented asymmetrical design give you even more protection. UL certified. Meet ASTM F-1897-2008 standard.

Item #	Length	Price
225450	36"	\$117.39
225451	39"	\$121.99



ELVEX Chainsaw Safety Chaps - 90 Series

These 90 Series Elvex Chainsaw Chaps give you reliable protection that exceeds industry requirements. Made of a tough, 420-denier nylon facing, they resist cut throughs from chains moving up to 3,000' per min. 2,500' per minute is required by the American Pulpwood Association (APA). Specify outseam length: 33", 36" or 39". Length is measured from belt loop to bottom of chap. Orange color. NOTE: Not tested for use with electric chainsaws.

Item #	Description	Price
JE94	94 Series Chaps	\$106.99
159916	91 Series Chaps	\$117.39
10213	90 Series Chaps	\$79.99



MCR SAFETY Kevlar-Lined Cowhide Driver's Gloves

Provides ANSI Cut Level A2 protection

Premium-grade cowhide gloves are sewn and lined with DuPont™ Kevlar® for superior cut resistance. Ideal for a variety of applications including farming, landscaping and construction. Keystone thumb fits the natural curvature of your hand for added comfort. Shirred elastic back.

Item #	Size Range	Price
230018	S-2XL	\$19.99



Saw Buck™ Chainsaw Chaps

Ultimate chainsaw safety that's 5X stronger than steel

Saw Buck™ Chainsaw Chaps provide the ultimate safety protection with a four-ply layer that is pound-for-pound, 5X stronger than steel. Four adjustable leg straps and a nylon web belt provide a secure fit. Lightweight and flexible, these chaps allow for easy movement in any position. 2 lb.

NOTE: Not tested for use with electric chain saws.

Item #	Length	Color	Price
173458	32"	Orange	\$130.69
18042	32"	Green	\$130.69
18043	36"	Green	\$152.69
173459	36"	Orange	\$152.69
18044	40"	Green	\$164.99
173460	40"	Orange	\$164.99



RAC Apron-Style Chain Saw Chaps

Innovative RAC design reduces downtime with fast, easy strap and buckle repairs. Apron style offers full-front, 180° leg protection. Adjustable to various leg sizes and comfortable for all-day wear. Stretchable and adjustable trim-to-fit belt fits up to a 48" waist. Meet ASTM F1897-2008. UL approved. Specify length and inseam.

Item #	Description	Price
225362	Apron Style Chaps	\$94.99



Economy Chainsaw Apron Chaps

Made from tough, durable six-ply Engtex nylon. Interlocking leg buckles. Water- and oil-resistant fabric. Adjustable belt fits waist sizes 30-42. Length is measured from belt loop to bottom of chaps.

Item #	Price
174445	\$89.69



Summer Weight Chain Saw Pants

Ideal for cutting wood in warm environments. Six layers of Engtex™ protective fabric shield the wearer by jamming the moving parts of a chain saw chain on contact. The front outer shell is constructed of tough Ambush® material for rugged use and the back is made with breathable Visa® polyester for outstanding flexibility and comfort. All have 33" inseam. Meet OSHA 1910-266. Specify Size: S-2XL.

Item #	Price
92547	\$115.99



Torch On Wheels

Red Dragon Torch On Wheels simplifies flaming large-area and gives you more versatility compared to a small hand torch

Torch comes with two 24"L axles that provide awesome versatility. Use one axle when a narrow wheelbase (22"W) is desired, such as flaming weeds on a sidewalk. Use both axles to get a wider wheelbase (46"W) for applications like flaming raised seedbeds. Torch features an adjustable needle valve and has a 30"W approximate flaming width. Weighs 115 lb. NOTE: Propane tank not included. Some assembly required.

Item #	FT	Price
217609	*	\$949.99

*Item ships by Truck due to size and weight.



Propane Weed Burner Backpack Kit

Destroy weeds at the root without breaking your back with this Red Dragon propane weed burner

Kit includes: 33"L torch, 5'L hose, O.L. fitting, Squeeze valve with adjustable needle valve, Spark lighter and a 10-lb. (3-gal.) propane cylinder. NOTE: Propane tank must be filled locally.

Item #	Price
156374	\$284.99



Deerskin Leather Driver's Gloves

Soft and supple deerskin leather

You will appreciate the dexterity that you get due to the flexibility of the leather and the way in which these gloves are sewn. Keystone thumb improves range of movement. Only grade-A leather is used so you won't find the imperfections that are common in lesser-quality gloves. Elastic at the wrist provides a snug, comfortable fit.

Item #	Size Range	Price
21190	M-XL	\$21.99



Flame Engineering Weed Burner Torch

Turn your propane tank into a high-efficiency weed burner

This weed burner torch is a handy, industrial-grade tool with countless practical uses for the landscaper or homeowner. Choose from a small, low-heat flame to an impressive 500,000-BTU 2,050°F torch--with no smoke or fumes. Includes: P.O.L. fitting, 10'L neoprene hose and a 33-1/2"L torch with an adjustable valve and spark lighter.

Item #	Price
WB102	\$69.99



Flame Engineering Cylinder Dolly

This convenient dolly lets you carry your weed burner in one hand and tow the cylinder with the other

This heavy-duty dolly lets you easily move your gas cylinder when using our Weed Burner, Item #WB102. Silver color. Weighs 16 lb.

NOTE: Propane tank and torch not included.

Item #	Price
WD96	\$64.99



Flame Engineering 2,000,000 BTU Jet Torch

This 2,000,000 BTU Jet Torch easily knocks down heavy weeds and brush without using any harsh or dangerous chemicals

The 2,000,000 BTU Jet Torch maintains a pilot flame and is triggered to full flame with a convenient squeeze valve at the handle. Aluminum tubing facilitates the jet action, which makes this torch light and easy to handle. Kit contains: Torch with squeeze valve, Regulator, 25'L LP-gas hose, P.O.L. fitting, Pipe thread sealant

NOTE: We recommend no less than a 100-lb. vapor cylinder (not included).

Item #	FO	Price
G50008	■	\$239.99

■ Oversize item: additional shipping charges will apply.



Poly Fire Pump

Added padding for comfort and support

Allows you to enjoy all the benefits of steel fire pumps with less weight and no rusting. Features a 52"L spray hose, adjustable shoulder straps and a single-action brass pump that includes both a stream and fan nozzle. Features padded shoulder straps, a waist strap and a lumbar support for extra support and comfort. 5 gal. capacity.

Item #	Price
139618	\$160.99



bond First-Cut Bamboo Stakes

Perfect for field staking, container plants or use in your garden. This bamboo is first cut, meaning it is the most durable and flexible section cut from each harvested piece. Contains no knots, cross grains or weak points, making it resistant to breaks and splinters. All-natural with no added dyes. Sold by the bale. .

Item #	Diameter	Length	Qty./Pkg.	FT	FO	Price
170973	1"	8'	50	*		\$105.99
170975	1"	10'	50	*		\$105.99
170968	1"	5'	100		■	\$119.99
170970	1"	6'	100		■	\$149.99
170971	5/8"	7'	200	*		\$163.99
152462	3/8"	3'	500			\$59.99
227495	3/4"	6'	100		■	\$64.99
227493	1/2"	4'	250		■	\$67.99
227494	7/16"	5'	250		■	\$67.99
152464	3/8"	4'	500		■	\$72.99
170967	1/2"	5'	250		■	\$79.99
170972	3/4"	7'	100		■	\$89.99
170969	1/2"	6'	250		■	\$99.99



bond First-Cut, Green-Dyed Bamboo

This first-cut bamboo is flexible and durable, making it ideal for field staking, containers and gardening

This super-strong Bamboo is dyed green so it blends in to the foliage, becoming nearly invisible. First-cut for flexibility and durability. Ideal for field staking, container plants or gardening. Sold by the bale in lengths from 18"L to 6'L. Bamboo is a natural product, so variations in diameter may be seen.

NOTE: These stakes are a natural product, therefore, variations may be seen in each bundle.

Item #	Diameter	Length	Qty./Pkg.	FO	Price
217542	1/4"	1-1/2'	2000		\$119.99
217545	5/16"	3'	1000		\$119.99
217546	3/8"	3'	1000	■	\$119.99
217548	7/16"	5'	500	■	\$149.99
217547	3/8"	4'	500	■	\$77.49

■ Oversize item: additional shipping charges will apply.



bond Bamboo Super Poles

Handle your toughest staking jobs

Each of these Bamboo Super Poles is made from first-cut bamboo, hand selected and sanded for the finest quality. This Bamboo is the strongest on the market, with minimal taper. This bamboo is carefully selected so knots, cross grains and weak points are reduced, making it resistant to breaks and splinters. Sold by the bale in lengths from 5'L to 8'L. These stakes are a natural product, therefore, variations in diameter may be seen in each bundle. Specify dimensions and quantity.

Item #	Diameter	Length	Qty./Pkg.	FO	FT	Price
217553	1-1/2"	6'	30	■		\$114.99
217550	1"	5'	100	■		\$199.99
217551	1"	6'	100	■		\$199.99
217554	1"	8'	100		*	\$231.99

*Item ships by Truck due to size and weight.

■ Oversize item: additional shipping charges will apply.



bond Kiln-Dried, Redwood Stakes

These Redwood Stakes are long lasting and extra-strong for a variety of applications

These Kiln-Dried Redwood Stakes are ideal for staking trees and vegetables, yet durable enough for construction or surveying applications. Available in bundles from 1' to 8'L lengths.

NOTE: Dimensions are nominal.

Item #	Measurement	Qty./Pkg.	FO	FT	Price
217563	1'L x 1-1/2"W x 1"D	50			\$17.79
217564	1-1/2'L x 1-1/2"W x 1"D	50			\$26.49
217557	4'L x 1"W x 1"D	25	■		\$34.99
217562	8'L x 1-1/2"W x 1-1/2"D	6		*	\$36.99
217558	5'L x 1"W x 1"D	25	■		\$39.99
217559	6'L x 1"W x 1"D	25	■		\$46.99



bond Hardwood Plant and Tree Stakes

Made of an extremely hard, kiln-dried wood and are an excellent choice for keeping small trees, shrubs, and vegetables upright. One end has a pencil-sharpened point for easier penetration into soil.

Item #	Width	Diameter	Length	FO	Price
192424	1/2"	1/2"	3'		\$18.99
192425	3/4"	3/4"	4'	■	\$29.99
192426	3/4"	3/4"	5'	■	\$39.99
192427	3/4"	3/4"	6'	■	\$49.99
192423	1/2"	1/2"	2'		\$9.49

■ Oversize item: additional shipping charges will apply.



bond Super Steel Plant and Tree Stakes

Secure trees, shrubs, vines, tomatoes and other vegetable plants. Steel-cored stakes are covered with a green, weather-resistant plastic to prevent rusting. Ribs help keep plant ties in place. Standard 20 per pack, Heavy-duty 10 per pack.

Item #	Diameter	Length	Qty./Pkg.	FO	FT	Price
198435	5/16"	2'	20			\$16.49
198436	5/16"	3'	20			\$18.99
198437	5/16"	4'	20	■		\$22.99
198438	7/16"	5'	20	■		\$27.99
198439	7/16"	6'	20	■		\$38.99
198440	3/4"	6'	10	■		\$49.99
198441	3/4"	7'	10	■		\$52.99
198442	3/4"	8'	10		*	\$56.99

*Item ships by Truck due to size and weight.



bond Fiberglass Plant and Tree Stakes

These fiberglass plant and tree stakes are the highest-quality, longest-life stakes we carry

The highest-quality, longest-life stakes we carry. Feature the flexibility of bamboo to allow movement during windy conditions but are strong enough to keep plants sturdy in high winds. UV-stable fiberglass won't rust or rot and is not affected by temperature. Ideal for trees, shrubs, vine,s tomatoes, etc. One sharp end for ground penetration. Green color blends with plantings.

Item #	Diameter	Length	Qty./Pkg.	FO	FT	Price
198455	1/2"	4'	10	■		\$38.99
198456	5/8"	5'	10	■		\$59.99
198457	7/8"	6'	5	■		\$65.99
198458	7/8"	8'	5		*	\$83.99

*Item ships by Truck due to size and weight.

■ Oversize item: additional shipping charges will apply.



bond. Twist Tie Plant Ties

Twist ties are easy to use and long lasting. Waterproof and ideal for tying vegetable and vines. Plastic-Coated Wire-- comes in a plastic dispenser. Includes cutter. Pre-Cut Twist Ties-- each pack contains 100 ties cut to 8"L each.

Item #	Length	Price
198477	66'	\$2.99
198478	160'	\$4.59



bond. Soft-Coated Twist Ties

Strong, lightweight, easy to use and long-lasting

Long-lasting, strong ties are waterproof and ideal for tying vegetable and vines. Dispenser with 16' of soft-coated, lightweight wire ties. Thicker than traditional twist ties, making them ideal for medium-duty applications like tying plants, young trees and extension cords. Colored green to hide in your garden. Dispenser with 16"L soft-coated wire ties.

Item #	Price
198480	\$4.99



Tree Staking Material

Stake trees without damaging tree bark

This soft polypropylene tree-staking material easily fastens to any anchoring system. It has a unique weave with a round edge to prevent bark damage. 900-lb. test strength stands up to wind, yet allows trunk to sway and build strength. Designed to replace wire and hose.

Item #	Roll Length	Price
152126	250'	\$39.99
139325	3,000'	\$399.99
139324	500'	\$73.99



Tree Anchoring Kit

This convenient anchoring kit has everything you need for quick and easy anchoring of trees up to 3" in dia. Complete kit for one tree.

Item #	Price
139326	\$18.99



Auger-Style Anchors

Securely anchor large, heavy-duty items

Auger-Style Anchors are great for securing large, heavy-duty items like temporary structures, tarps, trailers, bike racks and more. 10-gauge helical flights cut through the soil 4"D for every 360° turn for easy installation and removal. 30"L x 4"-dia. **10" Flighting**- 2,800-lb. holding capacity. **20" Flighting**-3,500-lb. holding capacity.

Item #	Landscap e & Nursery: Size	Price
227546	10"	\$29.99
227547	20"	\$36.99



bond. Jute Twine Roll

Gentle on plants and blends right in

Perfect for landscaping and garden tasks. Blends in with most plants.

Select color from the drop-down menu above.

Need more options?

Item #	Landscap e & Nursery: Color	Price
198464	Natural	\$2.99
198466	Green	\$3.49



Treated Sisal Twine

Heavy-duty, rot-resistant twine ideal for binding and baling

This is the ideal accessory for securing burlap to root balls but can be used for a wide variety of applications. Available in treated (mildew and rot resistant) and plain varieties. Comes in a 10-lb ball of twine. Extra heavy-duty construction for strength.

Item #	Landscape & Nursery: Size	Price
192923	1-Ply	\$25.99
192927	3-Ply	\$25.99
192925	2-Ply	\$25.99



Sisal Plain Twine

The ideal accessory for securing burlap to root balls, but can also be used for a wide variety of home, business, ag or garden applications

This is the ideal accessory for securing burlap to root balls but can be used for a wide variety of applications. Available in treated (mildew and rot resistant) and plain varieties. Comes in a 10-lb ball of twine. Extra heavy-duty construction for strength.

Item #	Landscape & Nursery: Size	Price
192924	2-Ply	\$24.99
192926	3-Ply	\$24.99
192922	1-Ply	\$24.99



band Plant Tie Taping Gun

Save time staking and tying plants, trees and vines with this super convenient tape gun

With a simple squeeze of the hand, this tape gun neatly wraps tape around the plant stem, then cuts and staples the tape securely to a plant support. Order tape rolls (Item No. 171295), staples (Item No. 171294) and replacement blades (Item No. 171293) for tape machine separately.

Item #	Description	Price
171293	Replacement Blades	\$19.99
171295	Tape	\$2.49
171294	Staples	\$7.49
171292	Tape Gun	\$85.99



Auger-Style Tree Anchor, 30"L

Extra holding power for trees, tents and shelters

This 30" screw-in style anchoring device is ideal for anchoring larger trees, but can also be used to anchor tents, shelters and portable sheds. Sold in pkg. of 12.

Item #	Length	Price
113145	15"L	\$69.99
113146	30"L	\$91.99



ArborGard Tree Trunk Protector

This polyethylene wraparound guard protects young tree trunks from damage caused by lawn care equipment and pesky wildlife

Lawn care equipment and rodent can permanently damage or kill young trees. This 25%-recycled polyethylene wraparound guard expands as the tree grows, so there are no adjustments needed for trunk diameter. Made in a muted gray tree bark color with ultraviolet inhibitors and will not lose its shape or color due to sun exposure. Holes in guard are the right size to discourage rodents, yet allow the bark to breathe so rot does not develop. Protects trunks up to 4" dia. Larger trees can be protected by joining multiple guards together. 9"H.

Item #	Qty./Pkg.	Price
158593	6	\$13.59
153379	100	\$162.99
158592	12	\$24.99



Rigid Seedling Protector Tubes

Protect your young trees and seedlings from hungry deer, elk, rabbits and other pests that cause damage

Effective method for long-term protection of your newly planted tree seedlings. Over the course of 2-4 yr., UV light causes the tubes to naturally disintegrate. Support seedling protector tubes with biodegradable bamboo stakes, sold separately.

Due to the length of these items, additional shipping charges apply. Our Customer Service team will contact you with the additional costs for your approval.

Item #	Diameter	Qty./Pkg.	Roll Length	FT	Price
139794	5"	150	30"		\$109.99
139795	5"	150	36"	*	\$109.99
152470	3-1/4"	400	18"		\$116.99
139793	4-1/2"	200	36"	*	\$120.99
139789	4"	250	36"	*	\$124.99
139791	4"	200	48"	*	\$142.99
139790	4"	250	42"	*	\$148.99
139796	5"	150	48"	*	\$164.99
139792	4"	200	60"	*	\$179.99
152471	3-1/4"	250	24"		\$72.99
152472	3-1/4"	250	30"		\$83.99
152473	3-1/4"	250	36"		\$94.99

*Item ships by Truck due to size and weight.



Treekote® Tree Wound Dressing

Protect injured trees, shrubs and vines from decay, insects and fungi

Apply Treekote Tree Wound Dressing to freshly pruned areas. Can also be used for grafting, propagating orchards or patching damaged trees.

Select size and style from the drop-down menus above.

Need more Options?

Item #	Landscape & Nursery: Size	Type	HM	Price
226576	1 qt.	Tub		\$12.79
226575	1 qt.	Brush-Top Bottle		\$12.79
226577	1 gal.	Pail		\$33.99
226578	12 oz.	Aerosol Can	▲	\$9.49

▲ Requires special handling due to DOT regulations. Additional shipping charges will apply. Cannot be shipped by air.



TUBEX Combitube Tree Shelters

Ventilated protection gives young trees a chance to acclimate

45cm solid base creates a safe microclimate to boost survival and promote healthy growth. Pre-fitted releasable ties for fast installation and easy maintenance. Flared rim minimizes stem abrasion. Biopolymer tubes last a minimum of 5 years.

Item #	Length	Qty./Pkg.	FO	Price
229197	4'	5	■	\$20.99
229198	5'	5	■	\$25.49

■ Oversize item: additional shipping charges will apply.



DOSATRON Nutrient Injectors

Water powered. Provides consistent accuracy regardless of variations in water flow and they're pressure mounted in the water lines. Designed to inject preset amounts of products into the water supply. **11-GPM & 14GPM units have 3/4" NPT fittings. 20-GPM unit has 1" NPT. 40-GPM has 1-1/2" NPT, 100-GPM has 2" NPT fittings. 200 mesh filter required for a valid warranty (sold separately).**

NOTE: A 200 mesh filter should be installed on the inlet side of the injector and is required for a valid warranty.

Item #	Max Flow Rate	In Flow Range	Percent Pressure Range	Ratios	Price
192229	100 gpm	6" Tu bi			



GEMPLER'S Liquid Iron Supplement for Plants

Get healthy plants when there's an iron deficiency in your soil

Liquid Iron Supplement for Plants provides iron that's immediately available to your plants and remains in the soil for extended feeding. It's compatible with most tank mixes of fertilizers or pesticides. For turf application, mix 5 to 10 gal. of liquid iron with enough water to cover one acre. For root feeding trees and shrubs, mix 4 oz. per inch of trunk diameter with 5 to 10 gal. of water and pour or inject around the drip line. Use 1 gal. in 64 gal. water for foliar applications. 1-gal. bottle contains 4.7% iron oxide.

Item #	Price
156302	\$24.99



Hortus IBA Water Soluble Salts™ Rooting Hormone

Salts require no alcohol to dissolve, reducing phytotoxicity

Hortus IBA Water Soluble Rooting Hormone contains 20% indole-3-butyric acid (IBA) water salts. Approved under WPS for zero-hour reentry interval. There's no need to dip each individual plant.

NOTE: Not for sale in California.

Note: not for sale in (AR).

Item #	Landscape & Nursery: Size	Price
227589	3.5 oz.	\$113.99
227590	8.8 oz.	\$180.99
227591	2.2 lb.	\$446.99



"This has to be one of the simplest ways to help take care of a tree. Within minutes it was installed and it is so easy to use. Built very well, I hope it last for a long time."

- keithd



Dew Right Tree Watering Bag

This watering bag is designed specifically to increase first-year survival rate and set the stage for a long, healthy tree life

20-gal. bag empties in 5 to 8 hr. and only needs to be refilled once or twice per week for most trees. Installs easily in just 5 minutes, without tools. A single bag fits trees up to 3" dia. Zip two bags together to fit a 3"- to 5"-dia. tree. Heavy-duty, green-coated polypropylene is UV stabilized to last after long hours in the sun. Safe to use with nutrient or chemical additives.

Item #	Pkg. Qty.	Price
217816	1	\$12.99
221884	12	\$142.99



Original 20-gal. Tree Watering Bag

Use this Treegator 20-gal. Tree Watering Bag to automatically water bushes, trees and more

Heavy-duty, 20-gal. bag is perfect for newly planted or established trees from 1" to 8" trunk diameters and only needs to be re-filled once every 5 to 7 days. Bags are quick and easy to install without tools, digging or staking. One bag will handle up to a 3"-dia. tree. Zip two bags together to handle 4" to 8"-dia. Trees.

Item #	Size	Price
RTG20	20 gal.	\$24.99



Jr. Tree Watering Bag

Keep difficult to water low-branch plants healthy with a steady supply of water

Heavy-duty round watering bag provides continuous watering for newly planted trees and shrubs. Eliminate hose watering, runoff and evaporation. Fills quickly and slowly. Waters over a 5 to 8 hour period. Use for trees, shrubs and bushes up to 6" dia. Doughnut shaped.

Item #	Size	Price
RTG150	15 gal.	\$23.49



Replacement Emitters

Replacement Emitters for Ooze Tube tree watering bags

Replacement emitters for 15-gal. (O) and 25-gal. (.) Ooze Tube tree watering bags.

Item #	Size	Drain Time	Tree Diameter	Price
146914	15 gal.	Up to 2 weeks	Up to 2" dia.	\$13.99
146915	25 gal.	1 to 4 weeks	2" to 5" dia.	\$17.99
151135	Replacement ooze tube			\$2.49



2" Disk Soil Moist w/ 10-10-10, pkg. of 100

Water holding polymer feeds and waters your trees, shrubs, turf and ornamental annuals. Soil Moist absorbs when watered, then slowly releases water to plants as they need it. Will not float to the surface. For indoor or outdoor plants. Soil Moist is nontoxic polyacrylamide. Wear eye protection and dust mask when mixing large quantities.

Item #	Size	Price
RSM400	40 Lbs	\$309.99
RSM200	2" Disk, Pkg of 100	\$67.99
RSM008	8 lb.	\$79.99



DP INDUSTRIES Bulk Hardwood Field and Plant Labels

Hi-vis colors make identifying plants quick and easy

These brightly colored wooden plant identification labels have an excellent writing surface and are easy to spot in your plantings making them ideal for greenhouses, nurseries, garden centers and gardeners. Sold by the case. 217919 (Assorted) contains 50 each of blue, orange, red, white and yellow.

Item #	Width	Height	Color	Qty./Pkg.	Price
G40560	5/8"	4"	Natural	1000	\$42.99
G40561	5/8"	6"	Natural	1000	\$48.99
G40566	1-1/8"	15"	Natural	100	\$49.99
G40562	5/8"	10"	Natural	500	\$52.49
G40565	1-1/8"	12"	Natural	250	\$56.99
G40567	1-1/8"	18"	Natural	100	\$57.99
151144	1-1/8"	12"	Orange	250	\$65.79
151145	1-1/8"	12"	Yellow	250	\$65.79
217916	1-1/8"	12"	Pink	250	\$65.79
217917	1-1/8"	12"	Red	250	\$65.79
217918	1-1/8"	12"	White	250	\$65.79
217914	1-1/8"	12"	Blue	250	\$65.79
217915	1-1/8"	12"	Green	250	\$65.79
G40563	7/8"	10"	Natural	500	\$67.99
217919	1-1/8"	12"	Multi	250	\$73.99
G40564	5/8"	12"	Natural	500	\$75.99
139516	1-3/8"	24"	Natural	100	\$88.79

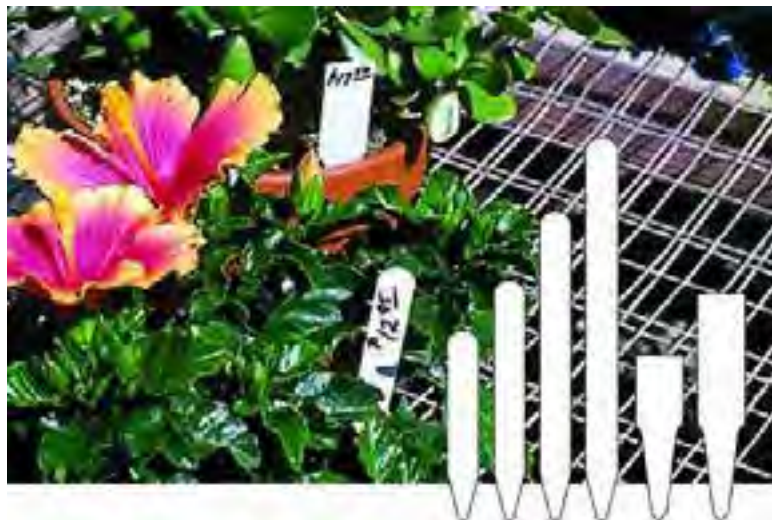

Plastic Plant Labels

These durable Plastic Plant Labels withstand harsh environments - perfect for the greenhouse or outside

These Plastic Plant Labels are produced from high impact recycled styrene, which produces one of the smoothest writing surface available. Use a permanent garden marker, Item No. M4962, for a long lasting label that is easy to read.

Item #	Width	Height	Qty./Pkg.	Price
G40584	1"	3-1/2"	1000	\$23.99
G40585	1"	4 1/2"	1000	\$27.99
G40580	5/8"	4"	1000	\$37.99
G40581	5/8"	5"	1000	\$43.99
G40583	5/8"	8"	1000	\$69.99



Vinyl Tree Tags

Multi-purpose Vinyl Tree Marking Tags

These vinyl tree tags have a slip-and-lock design for quick and easy labeling of trees, shrubs and more. Made of soft, pliable vinyl that won't damage delicate trees. Sold in rolls of 1,000 tags. Each tag is 5"L x 5/8"W.

Item #	Width	Qty./Pkg.	Price
G40570	5/8"	1000	\$31.99
G40571	5/8"	1000	\$43.99



NEW



Economy Suede Cowhide Palm Gloves

Cotton blend canvas on back of hand and cuff provides lightweight, breathable coverage. Cowhide palm and fingers for dexterity and abrasion resistance. Cowhide knuckle strap gives you extra protection from bumps and cuts. Safety cuff protects wrist area.

Item #	Size Range	Price
231176	M-XL	\$4.99



White Laser Strip Loop-Lock Tags

These weather-resistant tags stand up to the elements and still stay legible

These weather-resistant, White Laser Strip Loop-Lock Tags retain their strength, flexibility and legibility - even in the harshest conditions. Tags are colored on one side for easy identification.

NOTE: Microsoft Word®, Microsoft Publisher®, Label Factory® Deluxe and other software may be used to create professional-looking tags. Depending on the software, you can print prices, SKU numbers, item name and size and UPC bar codes. Includes instructions for Microsoft Word.

Item #	Width	Height	Qty./Pkg.	Price
151068	1"	6 3/4"	2500	\$142.99
151062	1"	11"	1000	\$69.99
151063	1"	11"	1000	\$73.99
151067	1"	11"	1000	\$73.99
151065	1"	11"	1000	\$73.99



Colored Tyvek ID Tags

These bright, all-weather tags are easy-to-find and ideal for marking larger trees or shrubs

Mark your trees, shrubs and other items for quick and easy identification with these Colored Tyvek ID Tags. 100 per package

Item #	Landscape & Nursery: Color	Price
24635	Yellow	\$33.79
24636		\$36.99



SEE ALL Vinyl Marking Tags

Durable plastic you can write on, offered in many sizes and colors, and with or without wires

These vinyl marking tags are an easy, effective way to identify equipment, leave instructions and more. Made from durable 10-mil plastic stock, they accept writing and typing. Tags are available in five sizes and colors with or without attachment wires. Pkg. of 25.

Item #	Landscape & Nursery: Color	Landscape & Nursery: Size	Type	Price
210525	Red	3-1/8" x 6-1/4"	No Wires	\$13.79
210521	Yellow	1-3/8" x 2-3/4"	No Wires	\$4.79
210516	Silver	1-3/8" x 2-3/4"	With Wires	\$5.79
210524	Red	2-5/8" x 5-1/4"	No Wires	\$9.79
210518	Silver	2-1/8" x 4-1/4"	With Wires	\$9.99



Permanent Metal Plant Markers

Permanent Metal Plant Marker easily outlasts disposable plastic or wooden markers

These permanent Zinc plant markers easily outlast disposable plastic or wooden markers. Writing on the soft, 2 1/2"W x 1"H Zinc nameplate with a soft lead pencil leaves a permanent marking that lasts for many seasons. Rustproof, weatherproof and resistant to ultraviolet fading. This marker is tilted at an angle for easy reading. The stable, double-prong base is ideal for marking plants in the ground and in large pots. Pkg. of 10.

Item #	Material	Height	Qty./Pkg.	Price
K436	Zinc	5"	10	\$6.79
K441	Zinc	10"	10	\$7.49
K443	Copper	10"	10	\$8.49



bond Reusable Plastic Plant Markers

Easily mark plants and plant rows

These plastic plant markers are reusable so you can clearly mark plants and plant rows year after year and save on stock up costs. 2"W x 1-1/2"H marking area allows for clear plant identification when used with a marking pen. 7-1/2"L gives excellent stability once inserted into the ground or pot. Pkg. of 25 markers.

Item #	Qty./Pkg.	Price
198467	25	\$3.99



Durable, Spike-Style Pot/Plot Markers

Durable spikes mark plants and pots

These heavy duty molded plastic pot/plot spikes help you color code your plant markings. Made of heavy duty molded plastic. 4-3/4" x 1/2". Specify Color: Blue, Green, Orange, Pink, Red, White or Yellow.

Item #	Width	Height	Qty./Pkg.	Price
151276	1/2"	4 3/4"	1000	\$52.79



Galvanized Steel Sign Holder

Post information exactly where you want

This durable, multi-purpose Galvanized Steel Sign Holder is crimped on four edges to keep your sign in place. Use alone as stakes or add the optional base adapter, Item No. 16BA (sold separately).

Item #	Width	Height	Length	Price
G49600	5"	4"	18"	\$2.59
G49603	7"	5"	18"	\$2.79
G49606	11"	7"	18"	\$3.09
G49601	5"	4"	30"	\$3.69
G49604	7"	5"	30"	\$3.89
G49605	7"	5"	42"	\$4.19
G49602	5"	4"	42"	\$4.19
G49607	11"	7"	30"	\$4.19
G49608	11"	7"	42"	\$4.79



COLLIER METAL SPECIALTIES

Galvanized Steel Base Adapter

Place your Steel Signs anywhere you want with this Galvanized Steel Base Adapter

This base adapter allows Galvanized Steel Sign Holders, Item No. G49600 through G49608, to stand unsupported.

Need more options?

Item #	Width	Length	Price
16BA	10"	10"	\$4.39



Vinyl Sign Cards

Waterproof and reusable vinyl sign cards

These vinyl sign cards are durable and printed with fade-resistant black and red ink. Each card is 7"W x 5"H and 0.010" thick. Signs fit into sign holders G49603, G49604 and G49605. 25 cards per pack. Specify card style (Sale or Border).

Item #	Width	Length	Qty./Pkg.	Price
G49501	7"	5"	25	\$8.29



Plant Information Sign Cards

Waterproof and reusable vinyl sign cards

These plant information cards provide crucial information to your customers before they buy. These durable, fade resistant cards are printed with fade resistant black ink and measure 7"W x 5"H and 0.010" thick. Cards fit easily into galvanized steel sign holders, items number G49603, G49604 and G49605. Pkg. of 25 cards.

Item #	Width	Length	Qty./Pkg.	Price
G49511	7"	5"	25	\$8.29

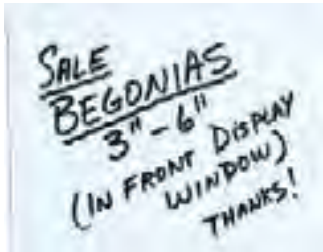

Vinyl Sign Cards

Vinyl Sign Cards

Make your own signs with these plain white vinyl sign cards. Durable, fade-resistant cards. Each card is 0.01" thick and fits easily into the galvanized steel sign holders. 25 pack of vinyl sign cards for use with sign holder item number B7111.

Item #	Width	Length	Price
B2511	11"	7"	\$13.79
B5454	4"	5"	\$5.49
B2575	7"	5"	\$7.49



Permanent Garden Marker

Ultraviolet filter dramatically reduces the fading effects of sunlight. The ink used in this Permanent Garden Marker is alcohol instead of petroleum based, making it safer and more environmentally friendly. Black ink.

NOTE: There will be an additional shipping charge. For specific details, please contact us or call us at 1-800-382-8473.

Note: not for sale in (AL;GA).

Item #	HM	Price
M4962	▲	\$4.59

▲ Requires special handling due to DOT regulations. Additional shipping charges will apply. Cannot be shipped by air.

Know the difference!

**1 HEAVY-DUTY
4-MIL VINYL**
resists cracking, fading,
mold and mildew

2 BETTER GLUE
helps keep flags from
falling off the staff

**3 HEAVIER-GAUGE
WIRE STAFFS**
are stronger, making
installation easy

**USA
MADE**

1
**GEMPLER'S
Quality-Assured
Product**

THE OTHER GUYS

1 Thinner-mil flags
break down more quickly

2 Low-quality glue
means more flags
end up like this

3 Flimsy wire staffs
have up to 17% less steel,
making installation a hassle

★★★★★ "...your vast selection of sizes and colors
made me feel like I was able to get the perfect flag for
my particular use. That's a good thing."

- Rick The Rocket, Warsaw, IN

Not all stake flags are created equal

Tired of your stake flags not holding up to the elements? Take a look above—the difference is unmistakable. What you need to get the job done right the first time is right here.



High-Visibility Outdoor-Grade Vinyl Stake Flags

Available in different staff lengths, staff materials and colors

Brightly colored and visible at long distances for marking a variety of applications such as irrigation lines, utility lines, boundaries, crop rows and nursery trees. Also ideal for indicating plant positioning, soil types and spray areas. Flags are constructed of heavy-duty 4-mil vinyl and are mold and mildew resistant. Wire stakes are constructed of sturdy 15.5-ga. steel wire. PVC stakes are solid 1/8"-dia. PVC plastic for increased safety around machinery and underground utilities. Wire stake flags are packed in bundles of 100; PVC are packed in bundles of 50. All sizes and lengths available in the fluorescent and standard colors displayed.

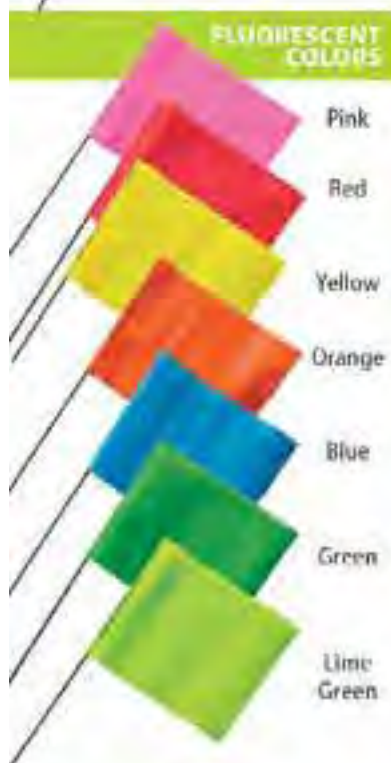

Item #	Stake Length	Flag Height	Flag Width	Price
Wire Staff (Bundle of 100)				
15VF1	15"	2-1/2"	3-1/2"	\$8.99
15VF2	15"	4"	5"	\$9.99
21VF1	21"	2-1/2"	3-1/2"	\$9.99
21VF2	21"	4"	5"	\$11.99
30VF1	30"	2-1/2"	3-1/2"	\$12.99
30VF2	30"	4"	5"	\$13.99
30VF3	30"	5"	8"	\$15.99
36VF1	36"	2-1/2"	3-1/2"	\$13.99
36VF2	36"	4"	5"	\$14.99
36VF3	36"	5"	8"	\$17.99
PVC Staff (Bundle of 50)				
127760	18"	4"	5"	\$4.99
127761	24"	4"	5"	\$5.99
127590	27"	5"	6"	\$6.99

High-visibility vinyl flagging tape cold rated to -28°F



Nurseryman's-Grade Vinyl Tape

Five styles in 45 different colors and patterns

Our flagging tape is brightly colored and easy to see at long distances. Great for marking tree and shrub locations in nurseries, tagging shrubs and trees on landscaping jobs, flagging boundaries/hazards on timberlands, distinguishing spray areas and retail labeling. Choose from brighter Hi-Vi fluorescent, standard colors, stripes, polka dots and checkerboard patterns. Fluorescent rolls are 150'L x 1-1/4" W. All other rolls are 300'L. If you prefer to order by the case, then the 144 roll will suit you best. **NOTE:** Polka dot, striped and checkerboard designs are ordered only.

Item #	Color	1-11	12-143	144+
Fluorescent				
44FG	Green-Glo	\$2.69	\$2.19	\$1.99
44FL	Lime-Glo	\$2.69	\$2.19	\$1.99
44FY	Yellow-Glo	\$2.69	\$2.19	\$1.99
44FB	Blue-Glo	\$2.69	\$2.19	\$1.99
44FR	Red-Glo	\$2.69	\$2.19	\$1.99
44FP	Pink-Glo	\$2.69	\$2.19	\$1.99
44FO	Orange-Glo	\$2.69	\$2.19	\$1.99
Standard				
44SG	Green	\$2.69	\$2.19	\$1.99
44SB	Black	\$2.69	\$2.19	\$1.99
44SW	White	\$2.69	\$2.19	\$1.99
44SR	Red	\$2.69	\$2.19	\$1.99
44SP	Pink	\$2.69	\$2.19	\$1.99
44SY	Yellow	\$2.69	\$2.19	\$1.99
44SO	Orange	\$2.69	\$2.19	\$1.99
44SI	Blue	\$2.69	\$2.19	\$1.99
44S4	Purple	\$2.69	\$2.19	\$1.99

Item #	Color	1-11	12-143	144+
Striped				
44SW	White/Black	\$3.49	\$2.99	\$2.59
44SYW	White/Yellow	\$3.49	\$2.99	\$2.59
44SOW	White/Orange	\$3.49	\$2.99	\$2.59
44SGW	White/Green	\$3.49	\$2.99	\$2.59
44SRW	White/Red	\$3.49	\$2.99	\$2.59
44SWB	White/Black	\$3.49	\$2.99	\$2.59
44SOB	Orange/Black	\$3.49	\$2.99	\$2.59
44SRB	Red/Black	\$3.49	\$2.99	\$2.59
44SGB	Green/Black	\$3.49	\$2.99	\$2.59
44SPW	Pink/Glo/White	\$3.49	\$2.99	\$2.59
44SYB	Yellow/Black	\$3.49	\$2.99	\$2.59
44SYR	Yellow/Red	\$3.49	\$2.99	\$2.59
Polka Dots				
44PRW	White/Red	\$2.89	\$2.39	\$1.99
44PBW	White/Black	\$2.89	\$2.39	\$1.99
44PGR	White/Green	\$2.89	\$2.39	\$1.99
44POW	White/Orange	\$2.89	\$2.39	\$1.99
44PWB	White/Black	\$2.89	\$2.39	\$1.99
44PYB	Yellow/Black	\$2.89	\$2.39	\$1.99
44PYR	Yellow/Red	\$2.89	\$2.39	\$1.99
44PBR	Red/Black	\$2.89	\$2.39	\$1.99
44PBO	Orange/Black	\$2.89	\$2.39	\$1.99
44PBP	Pink/Glo/Black	\$2.89	\$2.39	\$1.99
Checkerboard				
44CRW	White/Red	\$2.89	\$2.39	\$1.99
44COW	White/Orange	\$2.89	\$2.39	\$1.99
44CPW	Pink/Glo/White	\$2.89	\$2.39	\$1.99
44CRB	Red/Black	\$2.89	\$2.39	\$1.99
44CWB	White/Black	\$2.89	\$2.39	\$1.99
44CYB	Yellow/Black	\$2.89	\$2.39	\$1.99
44CGB	Green/Black	\$2.89	\$2.39	\$1.99



8"L x 10"W Marking Flags

Bright orange flag is visible at long distances and ideal for marking field tile, crop rows, construction sites, etc. Features a 5/16"-dia. fiberglass staff. Includes a 5"L piece of yellow reflective tape that's wrapped around the staff just below the flag.

Item #	Stake Length	FO	FT	Price
171040	5'	■		\$5.59
171041	8'		*	\$6.39

*Item ships by Truck due to size and weight.

■ Oversize item: additional shipping charges will apply.



Extra-Large, Hi-Vis Marking Flag

Extra-Large Flag is easy to spot from a distance and ideal for marking field tile, crop rows and construction sites

This Extra-Large, Hi-Vis Flag features a staff with a 5"H band of yellow reflective tape just below flag for added visibility in low light conditions. Fiberglass staff is 3/8" dia.

Item #	Stake Length	FT	FO	Price
221847	8'	*		\$12.99
221846	5'		■	\$9.99

*Item ships by Truck due to size and weight.

■ Oversize item: additional shipping charges will apply.



Blackburn Bulk Flagging Tape

Bulk flagging tape to mark off large areas

This bulk marking tape is perfect for times for when you need a lot of tape to mark off a large area. Convenient self-dispensing box makes it easy to access and store. Heavy-duty 4-mil vinyl construction.

Item #	Landscape & Nursery: Color	Price
224110	Fluorescent Green	\$11.24
224110	Fluorescent Orange	\$14.99



PRESCO Biodegradable Flagging Tape

A great way to mark objects for quick and easy identification that's also non-toxic to animals

This brightly colored Biodegradable Flagging Tape is made from all organic, non-toxic recycled cellulosic materials that will not harm livestock or wildlife if eaten.

The intense color lasts for three months in direct sunlight. Tape measures 1"W x 100'L. Call for quantity discounts.

Item #	Price
52273	\$2.59



Open Reel Fiberglass Measuring Taps

Fiberglass-infused measuring tape withstands heavy use

Molded open reel with shovel handle is easy to grasp and ideal for rapid reeling. Crank handle is metal reinforced for years of use. 1/2"W guide to prevent twisting.

Item #	Blade Length	Price
G52850	50'	\$15.99
G52810	100'	\$21.99
G52820	200'	\$39.99
G52830	300'	\$54.99



Open Reel Double-Sided Fiberglass Measuring Tape

Fiberglass-infused measuring tape withstands heavy use

Molded open reel with shovel handle is easy to grasp and ideal for rapid reeling. Crank handle is metal reinforced for years of use. 1/2"W guide to prevent twisting.

Item #	Blade Length	Price
G58105	50'	\$15.99
G58100	100'	\$26.99
G58200	200'	\$48.99
G58300	300'	\$73.99



Professional Steel Tape Measures

Get superior accuracy with this durable measuring tape designed for the rigors of outdoors

Durable design, rustproof stainless steel housing. 3/8"W Perma-Clad blade has two coats of nylon over the steel core. Metal crank and nonslip rubber grip handle provide smooth action during blade winding.

Item #	Blade Length	Price
217675	300'	\$144.49
145639	100'	\$63.23
217674	200'	\$85.84



Waterproof, Shockproof Timer

Use this durable Waterproof/Shockproof Timer/Stopwatch for time sampling and application routines

Use as a stopwatch or clock to time your field work in all kinds of weather. Displays large, 5/8"H digits. Measures 2-1/8"W x 2-3/8"H x 1/2"D. 1-oz. Includes two-year battery and lanyard.

Item #	Price
R34527	\$22.49



KOMELOM Series 79 Measuring Wheel

Ideal for rough terrain

Use this large, 6.6'- circumference wheel for acreage computation. The 1-1/8"W surface and strength of the polystyrene wheel makes it ideal for land measurements on rough terrain. Folding handle with comfort pistol grips. Easy transport and storage. Commercial five-digit counter display. Measures up to 99,999 units.

Item #	Description	Wheel Dia.	Price
79MWC	Feet and Inches	25"	\$101.99

KESON Raised-Counter Measuring Wheel

You'll love the intuitive design of this measuring wheel - it makes reading measurements quick and easy

The counter is placed above the wheel instead of the side for closer, easier viewing. Better yet, the counter reset is on the handle. Features include a brake on the pistol grip so you can stop measuring instantly, a flip-down kickstand to keep the wheel upright to free hands for other tasks. 12"-dia. molded ABS wheel and center-line handle design provides perfect balance. Unit folds to half its normal size for easy storage. Five-digit counter measures in feet and inches up to 9,999', 11".



Item #	Wheel Dia.	Price
215013	12"	\$99.99

KESON RoadRunner® Measuring Wheel

Quickly and easily compute area measurements

This professional-grade 15-1/2" digital measuring wheel is loaded with convenient features to make your measuring jobs easier. Features include an eight-measurement memory, backlit LCD display, "wheel radius addition" for wall-to-wall measuring, area calculation and auto shutoff. Unit reads feet, inches, continuous inches, 10ths and metric. Seven-digit display reads up to 99,999 ft. 11 inch. or 99,999.9 in 10ths and metric. Additional features include a collapsible handle for easy storage, kickstand and 3/4"-dia. steel tube frame. Accuracy is ±2" per 100'. Requires (2) AA batteries (not included). 8.4 lb.



Item #	Wheel Dia.	Price
163172	15-1/2"	\$204.39



M-97 Metal Detector

Pinpoint hidden or lost metallic objects fast

This Fisher M-97 Metal Detector quickly pinpoints buried survey markers, conduit, meters, and other concealed metallic objects made of aluminum, brass, copper, iron, lead, nickel or tin. Metal detector features push-button tuning, auto-tune circuitry and sensitivity selector to get you started in no time at all. Includes an 8" coil.

Item #	Price
107202	\$659.99



KESON Tally Meters

Keep track of counts in the lab or field

Use these plated-metal counting meters to tally up pest counts in the lab or in the field. Each unit counts up to 9,999. Dial resets to zero. Three key counters are permanently mounted on a metal base with predrilled bolt holes for attaching to your work surface. Each counter measures 2-1/2"H x 2-1/2"W.

Item #	Description	Price
R34500	Single Key	\$13.49
R34550	3 Key	\$57.99
R34575	5 Key	\$87.99



KESON 30'L Powerglide Locking Tape Measure with Rubber Grip

Ideal for contractors, technicians, growers and homeowners

This high-quality locking tape measure is a must for contractors, growers, technicians—anyone who needs precise measurements. This locking tape measure has a 1"W x 30'L steel tape in a chrome-plated case with rubber grip. The sturdy tape stays ridged for about 8'. Tape is printed with 16" center and 19.3" rafter markings and reads in feet and inches in 1/8" and 1/16" increments. Includes chrome-plated belt clip.

Item #	Price
G74031	\$13.79



KOMELON Stainless Steel Gripper Tapes

Nylon blade coating is perfect for use in wet areas

Ideal for outdoor workers because it will stand up to harsh conditions. Stainless steel blade, end hook and inner components won't rust. Nylon-coated silver blade resists kinking and is easy to read in changing light conditions. Blue, rubberized housing provides impact protection and a slip-free grip.

Item #	Blade Length	Price
230418	16'	\$14.99
230419	25'	\$18.99
230420	30'	\$19.99



DeskMate II Mobile Office with Calculator

Ideal for those who spend a lot of time in their vehicles

This mobile office keeps documents protected when you're out in the field. This mobile office has a top-mounted solar or battery-powered calculator for quick access and the strong, low-profile clip on the exterior holds up to 1/2" of paper securely. Built from durable polypropylene with a bottom that opens to a large internal storage area for holding pads, pens and more. 16 1/16"L x 10"W x 1"D overall. Calculator battery included.

Item #	Size	Price
165745	16-1/16"L x 10"W x 1"D	\$16.29



Bottom-Opening Clipboard with Dual Storage

Clipboard with dual storage is your in-field workstation

This 1-1/2"D Bottom-Opening Clipboard with Dual Storage is ideal for carrying forms, loose sheets or pads. Removable upper compartment offers a 7/16"D capacity. Removable lower compartment has 1"D capacity for storing writing instruments and supplies. Weighs 3 lb.

Item #	Size	Price
G58515	8-1/2"W x 14"L	\$32.99



WorkMate II Mobile Work Station

Keep documents and small items organized and protected

WorkMate II clipboard features six internal divided sections for storage of desktop supplies. Strong, spring clip with rubber corner grips holds a 1/2" stack of paper securely. Clip is made of nickel-plated steel. Internal cover also holds sheets or pads of paper. Clipboard opens flat for tabletop or desk use and offers a large, smooth writing surface. Snap closure keeps materials secure and safe from weather. Clipboard is made of durable polypropylene.

Item #	Size	Price
148187	10-2/4"W x 13-2/5"L	\$14.99



Aluminum Field Binder

Stands up to tough field use, unlike cheap vinyl or plastic binders

Made from durable recycled aluminum with 60% post-consumer waste, Saunders 1 inch Ring Binder features a top quality clip system and flat spine with heavy duty hinges. Made in the USA!! Perfect for controlled environments, shop manuals, construction sites or to archive important documents!

Item #	Size	Price
12530	11"L x 8-1/2"W x 1"D	\$20.99



Soil Samplers

JMC soil sampler with step makes obtaining samples in hard-packed soils easy

JMC 36" L Nickel Plated Steel Alloy For large numbers of samples of for hard-packed soil, the long handle and sturdy footstep saves back strain. Core is 3/4" dia. X 12"L.

Oakfiled 36" L Chrome-Plated Steel Welded one-piece construction sampler includes footstep for dry, rocky or hard-to-penetrate soils. Tube is 3/4" dia X 11" L.

AMS 33" L Aircraft Quality Material Nickel plated to protect rusting. Tip is heat treated and wear resistant. 9" L cross handle unscrews for easy transport. Core is 1/2" dia X 12" L.

Item #	Description	Price
RJC036	JMC 36" Sampler	\$105.99



19" L Soil Probe

This JMC 19" L general-purpose soil sampler features one-piece construction for maximum durability and longer life

This nickel-plated, steel alloy JMC Soil Sampler is built to last. Self-sharpening tip helps penetrate the soil time after time. Features welded 3/4"-dia. x 17" L core. Weighs 1.2 lb.

Item #	Price
RJC019	\$45.99



Build Your Own JMC Soil Sampler

Choose the right tube and extension rods for your application...then add the handle! Attach extension rods to sampling tubes for extra length and deeper sampling. Both sizes can be threaded together in any combination.

Item #	Description	Price
RJC013	13" L Rod Extension	\$46.99
RJC026	26" L Rod Extension	\$50.99
RJC605	12" Tube for Dry Soils	\$72.99
RJC606	12" L Tube for Wet Soils	\$72.99
RJC608	18" L Tube for Wet Soils	\$77.99
RJC607	18" L Tube for Dry Soils	\$78.99
RJC101	Conventional Handle	\$89.99



3' L Collapsible Kit

This versatile, easily transportable and collapsible kit assembles to the length you need - 12", 24" or 36" L

This 36" L Soil Sampler is made from nickel-plated alloy steel for longer life. Kit includes: (1) 12" L handle, (2) 12" L extensions, (1) 12" L sample tube. Assemble a 12" L, 24" L or 36" L sampler as needed with this versatile, easy transportable kit. Core is 3/4" dia. x 12" L. Takes soil core sample of 12/16"-dia. x 9" L.

Item #	Price
RJC003	\$167.99



Model L 36\"/>

Ideal for deeper soil sampling where a footstep would get in the way

This 36\"/>

Item #	Price
72850	\$104.99



Apparatus 19\"/>

No need to worry about a bent or chipped soil probe tip with this Oakfield soil sampler

This Oakfield Soil Sampler has replaceable screw-on tips so you can keep it working at maximum efficiency to penetrate the toughest soil. Comes with one regular soil tip. Replacement tips sold separately: Dry Soil Tip (Item No. TP1), Regular Soil Tip (Item No. TP2), Wet Soil Tip (Item No. TP3) or Stony/Gravelly Soil Tip (Item No. TP4).

Item #	Price
OAK19	\$65.99



3' L Soil Sample Kit

Soil Sample Kit collapses to just 12\"/>

Chrome plated steel with replaceable tips. Soil probe collapses for easy transport and storage. Kit includes on 12\"/>

Item #	Price
OAK3	\$179.99



Replacement Tips for Oakfield Soil Probes

Replacement Soil Tip for Oakfield Soil Probes

This screw-on replaceable tip ensures you have a sharp tip to help penetrate regular soil when taking samples. For Oakfield Soil Samplers only.

Item #	Description	Price
TP2	Regular Soil Tip	\$10.99
TP3	Wet Soil Tip	\$10.99
TP4	Stony Soil Tip	\$10.99
TP1	Dry Soil Tip	\$10.99



AMS **Open-End Soil Probe**

A soil sampler developed for growers who need a quick way to obtain many samples

Developed for growers who need a fast way to obtain many samples. This AMS 33"L Open-End Soil Sampler with Handle is made from stronger-than-steel aircraft-quality material and triple-plated with chrome to prevent rusting. Probe is 1-1/8" dia. and is 33"L with a 13"L open slot. 10"L comfort-grip cross handle included.

Item #	Price
72875	\$159.99



AMS **21"L Soil Probe Sampler with Handle**

This AMS 21"L Soil Sampler is made from aircraft-quality steel and is triple-plated with chrome long long-lasting durability. Attach the optional Soil Ejector (Item # RAME21) to help remove samples easier.

Item #	Price
RAM021	\$56.99



AMS **Solid, One-Piece Augers**

Carry these one-piece tools and get to digging faster. Stainless steel cylinders, heat-treated carbon steel bits and durable powder-coat finish. Rugged construction won't come apart on the job. Rubber-coated grips ensure easy handling.

Item #	Length	Diameter	FO	Price
134647	53"	4"	■	\$164.99
134648	53"	2-3/4"	■	\$164.99

■ Oversize item: additional shipping charges will apply.



AMS 33\"/>

Made from aircraft-quality material and triple-plated with chrome to prevent rusting. Collapsible probe includes one 10\"/>

Item #	Price
RAMC3	\$205.59



AMS One-Piece Open-Faced Soil Auger

Auger practically pulls itself into the soil

Auger obtains extracts samples quickly and easily in mud, clay or hardpan soils. One-piece, open-faced auger features 10-ga., high-carbon steel construction with an aggressive, 2-1/2\"/>

Item #	FO	Price
152633	■	\$215.99

■ Oversize item: additional shipping charges will apply.



AMS Hammer-Head Soil Probe Kit

Eliminate the burden of carrying along a slide hammer while gathering samples of even the toughest soils

This AMS Hammer-Head Soil Probe Kit makes obtaining soil samples simple, even in hard, compacted ground.

Item #	Price
212133	\$195.99



AMS Soil Ejector for 21\"/>

Soil ejector makes removing soil samples easy

AMS soil ejector means you no longer have to dig out soil samples from the tube with your fingers—a simple slide of the ejector and your soil sample is removed. When the ejector is not needed, simply slide it all the way up the probe. Fits on AMS 21\"/>

Item #	Price
RAMC21	\$35.99



LaMotte Soil Sampling Tube

Get quick and easy visibility to the soil core with a convenient cut-away side

This LaMotte Soil Sampling Tube features galvanized steel construction and a saw-toothed cutting edge tapered for easy core removal. Takes a 1\"/>

Item #	Price
72840	\$32.99



GEMPLER'S Professional Soil Quality Test Kit

Modeled after a USDA-developed kit, this Gempler's Professional Soil Quality Test Kit includes the tools you need for a thorough assessment of your soil's ability to perform its critical functions including: supporting plant and animal productivity, contributing to clean surface and groundwater supplies, and enhancing human health, habitation and recreation. Save time and money by testing your soil quality without having to send samples to the lab. Kit can complete 25 soil nitrate tests, 10 soil respiration tests and many other critical tests. Includes an easy to follow instruction booklet.

Item #	Price
RGM250	\$804.99



LaMotte Professional Soil Nutrient Test Kit

Includes all the tests in the Macronutrient Kit, plus 50 additional tests each for ammonia nitrogen, manganese, aluminum, nitrite nitrogen, sulfate, chloride and ferric iron. Reads ppm.
Note: not for sale in (AL;GA).

Item #	Description	HM	Price
RLMCR	Professional Refill	▲	\$379.99
RLMC	Professional Kit	▲	\$609.99

▲ Requires special handling due to DOT regulations. Additional shipping charges will apply. Cannot be shipped by air.



LaMotte Basic Soil Test Kit

LaMotte Basic Soil Test Kit includes everything you need for fast, reliable results when testing your soil for N, P, K and pH. Kit contains: Diagrammed instructions charts, Sample containers, test solutions. Kit performs 30 pH and 15 nitrogen, phosphorus and potassium tests.
Note: not for sale in (AL;GA).

Item #	Description	HM	Price
RLMBR	Basic Refill	▲	\$51.99
RLMB	Basic Kit	▲	\$59.99

▲ Requires special handling due to DOT regulations. Additional shipping charges will apply. Cannot be shipped by air.



LaMotte Macronutrient Soil Test Kit

100 pH tests and 50 each for nitrate nitrogen, phosphorus, potassium, humus, calcium and magnesium. Includes lightweight molded case with all components mounted in removable foam trays for easy use indoors or in the field. Reads in ppm.
Note: not for sale in (AL;GA).

Item #	Description	HM	Price
RLM100	Macronutrient Kit	▲	\$449.99

▲ Requires special handling due to DOT regulations. Additional shipping charges will apply. Cannot be shipped by air.



Mascaro Soil Profile Sampler

Extract perfect soil profiles every time with this heavy-duty, solid-steel sampler

Get perfect soil profiles for analyzing insect damage or root and layer analysis in your turf grass or agricultural soils with this easy-to-use sampler. Simply insert sampler into the soil like a shovel, then remove and open the unique hinged cutter blade to access the profile sample. Measures 26"L and weighs 4 lb.

Item #	Price
222118	\$219.99



LaMotte Macronutrient Plant Tissue Test, N-P-K

Test has everything to get qualitative results

Simplified plant tissue field tests help you determine whether your growing plants are receiving adequate amounts of nitrates, phosphorus and potassium from the soil. Requires just one diced green plant tissue sample that's been saturated in an extracting solution for each of the three N-P-K tests. WARNING: Reproductive Harm.

Note: not for sale in (AL;GA).

Item #	HM	Price
226173	▲	\$114.99

▲ Requires special handling due to DOT regulations. Additional shipping charges will apply. Cannot be shipped by air.



LaMotte NPK Soil Testing Kit

Extract and test soil for nitrogen, phosphorus and potassium

This popular kit provides everything you need to extract nutrients from soil samples and perform N, P and K tests for each. Includes N, P, K and Flocc Ex tablets, a graduated extraction tube, a pipette, a water-resistant color chart for interpreting results and turbidity chart. Illustrated, step-by-step instructions also included. Performs 50 tests.

Item #	Price
221774	\$28.99



LaMotte Micronutrient Plant Tissue Test Kit

Micronutrient Plant Tissue Test gives you qualitative results while you're in the field

Simplified field kit includes tests for ferrous and ferric iron, zinc, copper, manganese and boron. Each test is made from the sap of plant tissues, which is extracted by squeezing the tissue with pliers. "Spot" tests indicate presence or absence only. Includes 50 tests for each factor. Additional shipping charges will apply. Cannot be shipped by air.

Note: not for sale in (AL;GA).

Item #	Description	HM	Price
226177	Refill	▲	\$118.99
226175	Basic Kit	▲	\$127.99

▲ Requires special handling due to DOT regulations. Additional shipping



EXTECH Exstik Waterproof pH Pen

Flat-surface electrode works in liquids and semisolids

This multi-application application pen has a flat-surface replaceable electrode. Large, 3-1/2"W digital display with bar graph fluctuates to show changes in readings. Stores and recalls up to 15 readings. pH pen comes complete with meter and pH electrode, protective sensor cap, sample cup, four "LR44 button" batteries and neck strap. pH range: 0.00-14.00. Resolutions and accuracy: 0.01 pH. Temperature range: 32 to 149°F.

Note: not for sale in (AL;GA).

Item #	Description	HM	Price
G71500	ExStik with pH Sensor	▲	\$109.99
G71501	Replacement pH Sensor		\$50.59

▲ Requires special handling due to DOT regulations. Additional shipping charges will apply. Cannot be shipped by air.

Soil Analyzer

Quickly find out if you have too little or too much fertilizer in your greenhouse soil

This Soil Fertilizer Analyzer measures your soil's Nitrogen, Phosphorous and Potassium (N, P, K) content in combination while measuring the pH from 1 to 9. Soil fertilizer meter includes instructional booklet with how-to information along with optimum values. Probes are 3"L. Uses (1) AA battery (not included). Overall measurements are 6-3/4"H x 2-1/2"W x 1-1/4"D.

Item #	Price
G72000	\$25.99



Plastic pH Strips

Choose from a selection of pH ranges

Fast, easy way to test water pH. Flip-top vials open to dispense 1/4"W x 2-3/4"L test strips. Multiple ranges available - see gemplers.com for complete list. 100 strips per vial.

Item #	Price
183410	\$16.99



pH Test Strips

These pH Test Strips are great when you need a quick test and high resolution is not critical

Use these strips for quick tests when high resolution is not critical. This easy-to-use pH Test Kit measures the pH of clear liquids from 0-12, in increments of 1.0 pH. Plastic dispenser case conveniently fits in your pocket. Kit contains color charts and strips for up to 75 tests.

Item #	Price
PH50	\$6.99



Brix Refractometer

Automatic Brix Refractometer measures sugar content of ripening fruit

Brix Refractometer measures from 0°–32° Brix. Easy to use, simply place one to two drops of juice on the prism surface, close the cover and read the shaded area in the scale visible through the eyepiece. The reading is percent of sucrose in the sample or Brix. Comes with a padded case and instructions. Automatically temperature-compensated for accurate readings in any temperature without conversion ($\pm 0.2^\circ$ accuracy).

Item #	Price
125759	\$108.99



Exttech Sucrose Brix Refractometer

Get repeatable results with this easy-to-use Exttech Sucrose Brix Refractometer

This intuitive, compact Exttech Sucrose Brix Refractometer accurately measures the concentration of sugar in fruit juice. Features an easy-to-read scale with 0.2 resolution. Brix range is 0 to 32%. Accuracy: $\pm 0.2\%$. Includes case, calibration screwdriver, plastic pipette and calibration solution.

Item #	Price
99714	\$109.99



Forage Moisture Tester

Take the time and hassle out of moisture testing your silages, balage, hay and more

This easy-to-use Forage Moisture Tester measures the moisture content of silages, balage, hay, high-moisture grains, total mixed rations (TMR), wet distiller's grains and more. Obtain reliable, consistent moisture content measurements for forages in approximately 20-40 min. without using charts or waiting for lab results. Includes 110V heater with variable heat control and four fan settings, produce basket and 6-lb. (3,000g) scale. Scale is powered by one 110V or (3) AA batteries (included).

Item #	Price
167834	\$355.99



Hand-Operated Corn Sheller

Hand-Operated Corn Sheller is perfect for seed corn - kernels come off the ear with the germ ends intact

This Hand-Operated Corn Sheller removes kernels quickly and easily for moisture samples or seed corn. Simply push ear through the sheller, turning it as you go.

Item #	Price
RDK100	\$11.49



Turf pH Meter

Turf pH Meter measures directly in soils—no soil samples, mixing slurries or messy kits needed

This innovative Turf pH Meter can take pH readings at 1", 2", 3" and 4" depths to quickly tell you the pH in the thatch layer and root zone. Simply insert probe to the desired depth, allow to stand for 60 sec. and read the analog pH scale. Ideal for golf greens and fairways, sports fields and lawns. Unit is completely self contained—no batteries or chemicals required. 3.5 to 9 pH range. Made of weatherproof noncorrosive metal. 48"H.

NOTE: Turf pH Meter is not designed for testing loose soils and should only be used in densely packed sod.

Item #	FO	Price
222117	■	\$349.99

■ Oversize item: additional shipping charges will apply.



agraTronix 16-Grain Moisture Tester

Test the moisture levels of 16 different types of grain
 This Agratronix MT-16 Grain Moisture Tester can average up to 99 test results, and provides direct moisture readout for 16 grains, including: barley, canola, corn, flax, oats, rice (2), rye, sorghum, soybeans, sunflower (2) and wheat. Used by the USDA, it can be adjusted to match your local elevator. Includes a sturdy carrying case to protect the tester from dusty environments.

Item #	Price
109740	\$209.99



agraTronix Portable Grain Kit

Get one kit that measures the moisture content and test weight (pounds per bushel) for 40 different grains
 Convenient grain testing kit measures the moisture content and test weight (lb per bushel) for 40 different grains. Test weight is measured with a heavy-duty plastic, 15- 1/2 hanging grain scale. Scale reads 15-70lb. per bushel and also features a metric scale. Can be used to determine bin capacities and feed quality. Moisture percentage is measured by the MT-PRO.

Item #	Price
167911	\$297.99



DICKEY-john Mini GAC Plus Grain Moisture Tester

This DICKEY-john mini GAC Plus Grain Moisture Tester's internal scale eliminates pre-weighing
 Based on the GAC2100b U.S. Federal grain standard. Screw cap free, plus an internal scale eliminates pre-weighing. The mini GAC plus features a test weight readout. Moisture range is 5-45%, depending upon the grain type. Grain temperature range of 32 to 122°F. Sample size is approximately 1 pt. Can hold twenty 20-grain calibrations, but you can choose from over 450 calibrations that can be downloaded from the Dickey-John website. Includes 9V battery and carrying case. 11-7/8"H x 4-13/16"W x 8-5/16"D.
 Note: not for sale in (AL;GA).

Item #	HM	Price
151465	▲	\$659.99

▲ Requires special handling due to DOT regulations. Additional shipping charges will apply. Cannot be shipped by air.



agraTronix 40-Grain Multi-Language Moisture Tester

Customize the Agratronix 40-Grain, Multi-Language Moisture Tester to your operation by selecting your preferred language and grain scale
 This tester allows you to customize it to your own operation by selecting from seven different languages and 40 grain scales. Simply select the grain to be tested, fill the test cell, screw on the cap and wait a few seconds for the reading. Automatically compensates for temperature variables. Direct readout for more than 40 grains. Backlit display for night use. 9V batteries not included.

Item #	Price
G75616	\$259.99



agraTronix Hay Windrow Moisture Tester

Agratronix Hay Windrow Moisture Tester gives you an edge on hay production by letting you test hay before it's baled or chopped

The production of high quality hay and forage is dependent upon moisture content while you are baling or chopping. This innovative moisture tester allows you to test the hay before it is baled or chopped, eliminating the time and expense of using your equipment until the moisture content is correct. Just add loose hay or forage to a 5-gal. bucket (not included) and press the tester into the hay or forage for the measurement. Typical sample time is 30-60 seconds with an accuracy of ±4%. Measuring range is 12-70% moisture content. 9V alkaline battery not included.

Item #	Price
163134	\$311.99



agraTronix Hay Temperature and Moisture Tester

Agratronix HT-PRO Hay Temperature and Moisture Tester ensures quality and prevents storage losses

Whether you sell or buy hay you need to know the moisture content to insure top quality and prevent molding during storage. Portable, easy-to-use meter helps you monitor conditions so you know when to bale and how to store. Measures moisture levels from 8-44%. Convenient handle and durable 20"L probe design makes it easy to push tester into the tightest bales. Temperature range 33-225°F. Includes calibration clip.

Item #	Price
RHMT2	\$224.99



agraTronix Baler-Mounted Hay Moisture Tester

Agratronix Baler-Mounted Hay Moisture Tester measures hay moisture levels in square or round balers while you bale to eliminate storage loss

Know moisture levels while you bale to eliminate storage loss. Meter measures hay in square or round balers on the go. Backlit display is updated every 3-5 sec, so you have up-to-date moisture levels. Tests hay from 8-44% moisture and has a built in self-calibration button. Kit includes: display, sensor, 25'L sensor cable, water-resistant connectors and stainless steel hardware.

Item #	Price
RHT20	\$275.99



Hay Probe Sampler

This Hay Probe Sampler gives you fast, convenient and contamination-free sampling for small square bales

Attach this Hay Probe Sampler to your drill for fast collection of hay bale samples. Stainless steel serrated tip cuts through forage fast. Samples collect into a slide-and-seal bag that hangs from an ABS collection shield to prevent contamination. Cleanout rod pushes up to 20 hay core samples into a standard 1-gal. zip-lock bag - ensuring complete cleanout between samples. Choose 18"L probe for small square bales; 24"L probe for round bales and large squares. Hay Samplers compatible with 1/2" drills.

Item #	Pin Length	Price
205593	18"	\$225.49
205594	24"	\$263.29

Stop wrestling with your hose



Available
in 3 Colors



Tuff-Guard Kink-Free Water Hoses

Weigh 35 to 50% less
than comparable rubber hoses.

Professional-grade hoses have a unique polypropylene double-helix construction that does not kink and has no memory—makes reeling and unreeing super simple. Hoses are 5/8" dia. but feature full-flow brass fittings to allow a flow rate comparable to a 3/4"-dia. hose. Brass couplers thread onto the hose, making leaks virtually impossible. Maintain flexibility from -20° to 158°F. Working pressure of 100 psi and burst pressure of 300 psi at 70°F. 5/8" I.D.

Item #	Hose Length	Color	Price
223969	25'	Blue	\$41.99
217610	50'	Blue	\$67.99
223971	50'	Green	\$67.99
223970	50'	Red	\$67.99
221743	100'	Blue	\$123.99
226164	100'	Green	\$123.99

Professional-Grade
Unique extruded
3-layer design woven
fiber core for strength

35% Lighter
than conventional
hoses

Precision Full Flow
Brass fittings are crush
resistant and wrench
friendly



Maintain Flexibility
from -20° to 158°F and
coil easily



★★★★★ "I have had this hose for
three years. It is light, has never, and I
mean never, kinked."

- Jerry the gardener from Illinois and SC





SwivelGrip™ Garden Hose

The average garden hose is a pain in the posterior. Kinky, twisty, hard to wrangle, hard to connect. And isn't outdoor work hard enough? The Flexilla Swivelgrip eliminates all those problems - it's the most flexible hose you've ever used - almost like an extension of your arm. With SwivelGrip action, the hose turns freely inside the grip, uncoils easily, makes quick connections, and guarantees tangle-free yardwork. The superior O-ring provides a long term, leak free connection at the spigot. The hybrid polymer material is far more flexible than rubber or vinyl, even in extreme temperatures from -40 to 150 degrees F.

Item #	Hose I.D.	Hose Length	Price
231061	5/8"	100'	\$109.99
231059	5/8"	50'	\$59.99
231060	5/8"	75'	\$89.99



FLEXZILLA Pro Water Hose

One touch and you'll realize that Flexzilla is no ordinary water hose!

Great for not only simple watering jobs but also for tough jobs and extreme conditions. Professional grade hose is lightweight, lays flat and will not kink when under water pressure. The unique polymer construction of the PRO Water Hose allows for excellent flexibility from 35° to 150°F with no memory. Burst strength of 500 psi. 5/8" I.D. 3/4" GHT fittings and superior O-ring for a leak-free connection. Coils easily. Drinking water safe.

Item #	Hose I.D.	Hose Length	Price
226423	5/8"	50'	\$74.99
226425	5/8"	75'	\$82.49
226426	5/8"	100'	\$97.49



DRAMM® ColorStorm™ Reinforced Water Hoses

The last water hose you'll ever need - it resists annoying kinks and stands up to extreme temperatures and pressure like a champ

This Dramm ColorStorm Reinforced Water Hose features crushproof, 3/4" GHT nickel-plated brass fittings.

Item #	Hose I.D.	Hose Length	Price
163104	5/8"	100'	\$127.99
163106	3/4"	75'	\$129.99
163107	3/4"	100'	\$154.99
163102	5/8"	50'	\$67.99
163105	3/4"	50'	\$94.99
163103	5/8"	75'	\$99.99



DRAMM® ColorStorm™ Soaker Hose, 25'L

Evenly water gardens and flowerbeds while conserving water

Evenly and gently water gardens and flowerbeds while conserving water with this Dramm ColorStorm soaker hose.

Item #	Hose I.D.	Hose Length	Price
163158	5/8"	25'	\$21.99
163159	5/8"	50'	\$31.49



Extreme-Duty PVC Irrigation Hose

Ultra-high-quality hose has a smooth, black PVC inner tube and is covered with a smooth, opaque green PVC compound reinforced with high tensile strength yarn. For use in temperatures from 32°F to 122°F. Ideal for golf courses, sports turf professionals, nurseries, greenhouses, landscapers and ag producers. Max working pressure of 150 psi and 600-psi burst pressure. Standard 3/4" GHT.

Item #	Hose I.D.	Hose Length	Price
192962	3/4"	75'	\$129.99
192964	1"	50'	\$145.99
192961	3/4"	50'	\$159.99
192963	3/4"	100'	\$172.99
192965	1"	75'	\$195.99
192966	1"	100'	\$237.99



Ultralite High-Pressure Irrigation Hose

This Ultralite, High-Pressure Irrigation Hose is one of the highest-quality hoses you'll find

This kink-resistant hose is extremely lightweight but tough enough for professional irrigation jobs that require dragging over rugged terrain. Features a circular-woven single jacket combined with a spiral reinforcement and rubber lining on the interior. Exterior is polyester with polyurethane coating for abrasion resistance. 300-psi maximum working pressure and 1,200-psi burst pressure. For use in temperatures -50° to 112° F. 1" NPSH threads.

Item #	Hose I.D.	Hose Length	Price
192970	1"	50'	\$179.99
192971	1"	75'	\$266.99
192972	1"	100'	\$293.99



Dura Flow Hose

Dura Flow Hose provides maximum flow with all-weather flexibility

UV and weather resistant. Easily recoils after use. Features a working pressure of 250 psi and a burst pressure of 1,000 psi.

Item #	Hose I.D.	Hose Length	Price
211980	3/4"	50'	\$122.99
211983	1"	50'	\$149.99
211981	3/4"	75'	\$172.99
211984	1"	75'	\$222.99
211982	3/4"	100'	\$225.99
211985	1"	100'	\$282.99



Clear PVC Irrigation Hose

Clear PVC Irrigation Hose gives visual confirmation of flow

Made of abrasion-resistant PVC and reinforced with polyester yarn that reduces elongation under pressure. UV-, ozone- and weather-resistant. Constructed with nontoxic compounds and lightweight NSF-51-certified material. The 3/4" hoses have a 150 psi working pressure and a 600 psi burst pressure. The 1" hoses have a 125-psi working pressure with a 500-psi burst pressure.

Item #	Hose I.D.	Hose Length	Price
211992	1"	50'	\$129.99
211991	3/4"	100'	\$152.99
211994	1"	100'	\$219.99
211989	3/4"	50'	\$89.99



Lay-Flat Water Hose

Lightweight yet tough water hose

Circular woven lay-flat water hose is a great combination of light weight and durability. Made with an ultra-tough all polyester woven jacket with a high-tensile polyurethane National Safety Foundation liner. Resists kinks and stays flexible down to -54°F. Lay-flat design takes up less storage room. 3/4"-I.D. hose has brass GHT. 300-psi maximum working pressure.

Item #	Hose Length	Hose I.D.	Price
227601	50'	3/4"	\$75.99



Stanley FatMax® Professional-Grade Water Hose

Anti Kink™ technology keeps water hose laying flat

Anti-kink technology - won't kink under pressure and has zero memory. Male & Female swivel grip that easily connects to spigots and attachments. Swivel action ensures that either end can be easily attached and the hose can be extended without twisting.

Item #	Hose I.D.	Hose Length	Price
227729	5/8"	50'	\$41.99
227728	5/8"	50'	\$51.99
227731	5/8"	100'	\$74.99



APACHE Bulk Rubber Hoses

Create your own custom-made, general-purpose hose

Create your own custom-made, general-purpose hose that's ideal for air, water and mild ag chemicals. Excellent kink resistance and also resists abrasions, sunlight and weather. Hose temperature range is -40 to 212°F. 200-psi max pressure. Simply cut hose to desired length, purchase the fittings and clamps (sold separately) and attach to make your own hose. Specify Color: Black or Red.

Item #	Optional Hose Fittings	FO FT	Price
215099	3/4" Worm Gear Clamp		\$0.79
215104	1" Worm Gear Clamp		\$0.89
217534	1" Female NPSM x 1" Hose Barb.		\$11.99
217535	1" Male NPT x 1" Hose Barb		\$11.99
221905			\$154.99
221905			\$154.99
221911		■	\$189.99



APACHE Bulk PVC Hoses

Build your own hose to be sure you always have the right-sized hose on hand for your watering jobs. Simply cut the bulk hose to any desired length, then just add the fittings and clamps (sold separately) to create a custom hose. Clear PVC polymer hose is reinforced with nylon tire cord and is compatible with most water-soluble ag chemicals. Max pressure is 150 psi. Hose temperature range -20 to 150°F. Optional male and female fittings can be installed with worm gear clamps.

Item #	Hose I.D.	Hose Length	Price
215094	3/4"	100'	\$129.99
215100	1"	100'	\$169.99
215095	3/4"	200'	\$249.99
215101	1"	200'	\$319.99
215096	3/4"	300'	\$359.99



DRAMM® 330'L Bulk Water Hose

Durable hose is customizable to the length you need

Dramm ColorStorm™ Bulk Water Hose has a strong hexagonal shape that resists kinking and withstands abrasions and weathering.

Must use the Hose Crimper (Item #) and either the 5/8"-dia. or 3/4"-dia. Jaws (Item #), (depending on hose diameter) to customize your hose. 5/8"-dia. and 3/4"-dia. Hose Crimper Fittings/Ferrules (Item #) are sold separately. NOTE: These hoses do not have couplings.

Item #	Description	FO	Price
227548	Hose Crimper		\$106.99
227554	3/4" Female Fitting/Ferrule Set		\$109.99
227556	3/4" Splicer/Ferrule Set		\$113.99
227557	5/8" x 330' Hose	■	\$347.99
227558	3/4" x 330' Hose	■	\$429.99
227551	5/8" Male Fitting/Ferrule Set		\$63.99
227552	5/8" Female Fitting/Ferrule Set		\$65.99
227549	5/8" Hose Crimper Jaws		\$83.99
227550	3/4" Hose Crimper Jaws		\$83.99
227553	3/4" Male Fitting/Ferrule Set		\$87.99



DRAMM® 2"-dia. Aluminum Waterbreaker® Nozzle

Save time hand watering with this Dramm Waterbreaker Nozzle

Water your bedded plants and large pots quickly and efficiently with this unique Dramm nozzle. Handle sold separately.

Item #	Description	Price
WB17	1" dia. Aluminum Nozzle	\$11.99
G41561	2" dia Red Head Nozzle	\$13.49
217849	1000PL-N Narrow Pattern Nozzle	\$13.49
217850	1000PL-W Wide Pattern Nozzle	\$13.49
G41566	1" dia 480 Aluminum Nozzle	\$14.99
WB40	2" dia Aluminum Nozzle	\$20.49
217824	350PL Screen-Air Nozzle	\$29.49
540B	4" dia Brass Rose Nozzle	\$82.99



DRAMM® Commercial-Grade 30"L Aluminum Rain Wand

This heavy-duty 30"L Rain Wand helps you reach hard-to-water areas without hassle

Gently water your seed beds, plants and more with this fun-colored Dramm Rain Wand. Features anodized aluminum tubing, handle and a full-flow showerhead. Specify Color: Green, Berry, or Red.

Item #	Price
G48843	\$36.99



DRAMM® Revolver™ Spray Gun

Versatile enough to meet virtually all of your watering needs

Nine-pattern Revolver Spray Gun. Move from cleaning to watering with a twist. Constructed with heavy-duty metal and has an ergonomic, insulated grip. Easily switch between water flow selections with the quick-change feature. Variable flow rate.

Item #	Price
167797	\$14.99



PIRIT PVC Heated Hoses

thermostatically controlled hoses automatically turn on at 45°F or lower and off at 57°F or higher. Heater wires are extruded directly into the hose wall for uniform heating. Heating element plugs into any standard 110V GFCI outlet and draws 180W. Comes with a 72", 110V electrical cord. Meets UL and CSA requirements for heated, outdoor electric appliances. NOTE: Heated hoses should be used only with GFCI outlets. Hose should be unhooked from water source when not in use.

Item #	Price
215214	\$134.95
215215	\$175.99
215216	\$259.95



DRAMM® 6" Watering Extension Handle

Simplify hand watering jobs with this durable Dramm 6" extension handle

Simplify hand watering jobs with this durable extension handles. Ideal for watering hanging baskets, gardens, shrubs, flowerbeds. Constructed of drawn aluminum tubing to withstand rugged use. Fits standard 3/4" hose fittings. NOTE: Water breaker nozzles and plastic shut-off valve sold separately.



Item #	Description	FO	Price
D116	16"L Extension Handle		\$11.49
D124	24"L Extension Handle		\$12.49
D136	36"L Extension Handle		\$13.49
41364	36"L Hanging Basket Extension Handle		\$13.99
D148	48"L Extension Handle	■	\$14.99



DRAMM® Touch 'N Flow Pro™ Valve

Maximize valve opening for higher flow

Replace or update your current watering wand valve with this convenient one-touch trigger valve. High-output 11-gpm flow rate at 40 psi is unmatched by other trigger valves. Lightweight die-cast zinc body with rubber-molded grip offers durability and comfort. Features wire latch trigger lick for constant spraying or storage. 3/4" GHT fittings.

Item #	Price
167796	\$11.49



DRAMM® One-Touch Sprayer Valve

This One-Touch Sprayer Valve lets you adjust from off to full flow with a simple movement of your thumb

Control water flow quickly and easily with the convenient easy-slide valve. Features a durable zinc-die-cast body with a soft, durable rubber grip and machined brass threads. Nylon valve components ensure long life without leaking. Maximum water flow is 11 gpm at 40 psi. For professional use and can be used with watering wands. 3/4" GHT fittings.

Item #	Price
217823	\$17.49



Hose-End Nozzles

Dual Gallonage: Adjusts easily from a straight stream to a misting fog in a 10 to 25-gpm range. Progresses from a low pressure straight stream into a fan pattern. Great for equipment or stadium washdown.

High-Volume: Operates the same as the dual nozzle, but with a greater 20 to 60-gpm range. Use with a 1" I.D. for best results.

Constant Flow: Non-jump style that provides either a wide fog or straight stream pattern at 35-gpm. Use for heavy watering, syringing etc.

Item #	Description	Coupler	Price
192943	35 GPM Constant Flow Nozzle	1" NPSH	\$84.99
192942	10-24 GPM Dual Gallonage Nozzle	1" NPSH	\$84.99



Specialty Water Nozzles

Just right for turf management

Ideal for golf and sports turf management. Aluminum shower head nozzle, provides a heavy shower of water for flushing and irrigation. Includes a 3/4" GHT adapter.

Adjustable Fan Stream Nozzle allows you to adjust from a wide fan to an 80' smooth stream

Aluminum Flat Spray Nozzle provides a lower volume water flow pattern for dampening.

Item #	Description	Price
192949	Aluminum Flat Spray Nozzle	\$17.99
192950	Aluminum Shower Head Nozzle	\$27.99
192951	Adjustable Fan Stream Nozzle	\$75.99



Standard Pellet Applicator

Save water when watering turf and ornamentals

Apply pelletized wetting agents, surfactants and adjuvants to turf and ornamentals easily and precisely. Simply connect the applicator to a water source, fill the clear nylon pellet container and twist it on. O-ring seal keeps your applicator water-tight and precise. Features a swivel at the supply end along with a shutoff ball valve for maximum comfort and control. Works with 3/4" or 1" hoses. Available with either the flat spray or showerhead nozzle.

Item #	Description	Price
192957	Standard Pellet Applicator Showerhead Nozzle	\$122.99
192959	Standard Wetting Agent	\$14.99
192960	Kelp Extract Wetting Agent	\$21.49
192958	Standard Pellet Applicator	\$99.99



Underhill Magnum Solid Metal Industrial Water Nozzle

This industrial water nozzle is tough enough to handle high-demand areas such as golf courses, athletic fields and even equipment wash-down

This firehose-quality Underhill Magnum Solid Metal Industrial Water Nozzle is as tough as they come. It has no plastic internal parts to break, stick or wear out and has a solid metal internal body that holds up to years of rough use. Optional 1" brass adapter, is available.

Item #	Description	Price
147755	Magnum Nozzle	\$51.49



Gilmore Professional Water Nozzles

Commercial High-Flow Power Nozzle-

Heavy-duty zinc body, Thermo-guard insulated, reinforced brass stem and nut with glass-filled nylon handle. Hot water rated to 160°F. Water pressure rated to 100 psi. Adjusts from mist to a powerful stream. Lock-on water clip. Fits 3/4" hose fittings.

Industrial Pistol Nozzle-Heavy-duty, die cast metal body nozzle is rated to handle up to 250 psi and provides up to 300% more water flow than standard nozzles. Features Gripguard insulation on nozzle body and a metal on/off handle. Fits 3/4" hose fittings.

Item #	Description	Price
42280	Pistol Nozzle	\$13.49
139299	Power Nozzle	\$26.49



Retractable Water Hose Reel

Unique winding system layers hose neatly, smoothly back and forth across the reel - every single time, season after season. Hose reel can be set to swivel freely or lock into any of 7 positions. Latching mode switch allows for automatic rewinding. Both 70' hose and 10' lead-in **hose included**. Measures 19.5" x 18.5" x 12.7". Weighs 29.2 lbs.

Item #	Hose Length	Hose I.D.	Price
231062	70'	1/2"	\$279.99



Commercial-Duty Steel Garden Hose Reel Wagon

Tough and Durable

Sturdy 1" dia. 13-gal. steel tubing has a one-piece, welded steel reel that holds up to 300' of 5/8" hose. Long push-and-crank handles allow easy transport and winding. Large 10" dia. pneumatic tires keep the wagon rolling smoothly. Power-coated frame. 34-3/4"H. Note: Hose not included.

Item #	Price
224157	\$199.99



Extra Large Hose Wagon

Take on any terrain with the largest capacity hose reel we carry

Store and transport up to 350' of 5/8" I.D. hose on this heavy-duty steel frame hose wagon. Large, 10" pneumatic tires allow for easy maneuvering over turf or uneven terrain. Features a 13-ga., 1/2" dia. power coated frame and handle. 5'L leader hose and accessories basket included. Some assembly required. 38-3/4"H.

Note: Hose not included.

Item #	FO	Price
224158	■	\$144.99

■ Oversize item: additional shipping charges will apply.



Wall-Mount Hose Reel

Industrial-grade, wall-mount hose reel is made for commercial applications where extra hose distance is needed in a small, compact space

Reel holds up to 200' of 5/8" hose. Includes a 5'L leader hose. 13-ga. power-coated steel unit has brass and galvanized finishes. Four mounting options include: permanent or temporary wall mount, floor standing unit, or use stakes for a ground mounted reel. Fully assembled. Wall mount hardware not included.

Item #	Price
224159	\$129.99



**Tracker™ T-400
Portable Irrigation
Machine**

The Tracker T-400 allows you to economically irrigate large areas from 1/4 acre to 2 acres where an underground irrigation system would be too costly or impractical. Simply position the unit where you want to begin irrigating and connect to a water supply with a heavy-duty 1" I.D. hose. Unroll and anchor the nylon cable to the endpoint, set the speed control (which controls the application rate) and turn on the water. Includes a galvanized anchor stake, 360' of nylon cable and 1" brass quick couplers (for hose).

Item #	FO	Price
147640	■	\$2,100.00

■ Oversize item; additional shipping charges will apply.



Gilmour Telescoping High-Rise Tripod Sprinkler

Easily adjustable height for extra spray coverage

The Gilmour Telescoping High-rise Sprinkler Tripod is ideal for spraying newly seeded grass and plants.

Item #	Price
113431	\$84.99



RAIN BIRD Electronic Water Timer

Automate your watering schedule for maximum efficiency

Automate your hose-end sprinklers, drip irrigation or soaker hoses for consistent irrigation and maximum efficiency. Simply program watering up to two times per day, on any day(s) of the week. "Water Now" and "Cancel Watering" buttons allow you to override preset programs. A rain delay up to 6 hr. can be set without affecting the stored program. The unit displays program status, next scheduled cycle and the time remaining on the current cycle. For indoor/outdoor use in temperature ranges of 40° to 110°F. For use on cool water only, at pressures of 15-90 psi.

Item #	Price
217821	\$49.99



Gilmour Large Area Impulse Sprinkler

Covers 50% more ground than most other pulsating sprinklers

Extra-large impulse sprinkler is made of all-metal-heavy duty die cast zinc construction which provides superior durability. Adjustments for distance, rotation and spray control. Tree-prong spike base has an extra-wide foot step for secure placement in the turf and provides a coverage area up to 8,500 sq ft.

Item #	Price
113433	\$49.99



Superior™ 2000SX 3/4" Full-Circle Impact Sprinkler

Water your lawn and gardens without spending the time standing around doing it yourself

The versatile Superior 3/4" Full-Circle Impact Sprinkler is unlike models you'd commonly find at the hardware store. Sprinkler sprays with a full-circle operation at a 25° angle of trajectory - hitting your target without wasting water. Sprinkler features solid-brass construction and 3/4" male NPT inlet. Drive-side nozzle thread is 1/4"-18 UNF, and range-side nozzle thread is 3/8"-24 UNF.

Item #	Price
221810	\$32.99



Superior™ 261SDX 3/4" Part/Full-Circle Impact Sprinkler

The versatile Superior 3/4" Part/Full-Circle Impact Sprinkler is unlike models you'd commonly find at the hardware store. Sprinkler sprays with a part- or full-circle operation at a 25° angle of trajectory - hitting your target without wasting water. Sprinkler features solid-brass construction and 3/4" male NPT inlet. Drive-side nozzle thread is 1/4"-18 UNF, and filler nozzle thread is 3/8"-24 UNF.

Item #	Price
221811	\$61.99



Gilmore Single Brass Shut-off Valve

This Gilmore single brass shut-off valve fits 3/4" hose fittings and is rated for up to 100 psi.

Item #	Description	Price
125860	Single Shutoff	\$10.49
221888	Y-Shut Off Valve	\$21.49
221887	4-Way Shutoff	\$29.49



Underhill Brass Shutoff Valve

The orifice of this heavy-duty Brass Shutoff Valve is large enough for the full flow rates of all nozzles, and the handle is designed for extra clearance. Valve fits standard 3/4" hose threads and can converted to 1" hose thread with separate adapter, .

Item #	Description	Price
167801	1" Adaptor	\$10.99
147756	Shutoff Valve	\$11.49
134272	Shutoff Valve	\$24.99



Gilmore Brass Quick Connector - Male

For instant, leak-proof hose connections at the faucet, nozzle or sprinkler

Works with Female Quick Connector (Item No. G40108)
Replacement part used with Quick Connector Kit (Item No. G40109)

For instant, leak-proof hose connections at the faucet, nozzle or sprinkler.

Item #	Description	Price
G40109	Quick Connector Kit	\$11.99
G40107	Male Quick Connector	\$4.49



BANJO 3/4" Quick Connect Hose System

Quickly connect hoses without needing pliers to tighten for leak prevention. Fit standard 3/4" GHT. Durable, rustproof polypropylene construction.

Item #	Description	Price
222029	3/4" Coupler x 3/4" GHT Female	\$10.59
222028	3/4" Coupler x 3/4" GHT Male	\$10.59



DRAMM® Heavy Duty Plastic Watering Cans

A unique design and quality construction make this Dramm Plastic Watering Can a "must-have" for any gardener

Durable cans are made off high-grade, injection molded plastic for long life. Ergonomic oval handle design wraps around the can for great balance and control while watering. Smaller cans have plastic rose spouts and larger cans have a plastic elbow for easier pouring.

Item #	Description	Price
139421	1/2 Gallon with Plastic Rose	\$15.49
148027	1/3 gal.,Plastic,Rose	\$31.49
139423	1 3/4 Gal	\$34.99
139424	2 1/2 Gal	\$45.99



Underhill Gulp™ Ultramax Removal Suction Pump

This lightweight, self-priming water pump is the perfect solution for removing water from irrigation sprinklers and valve boxes, trenches or anywhere that water accumulates.

This lightweight, self-priming water pump is the perfect solution for removing water from irrigation sprinklers and valve boxes, trenches or anywhere that water accumulates.

NOTE: Repair kit sold separately.

Item #
WEB226274



RAIN BIRD® 100'L Emitter Tubing

Evenly water plants and flowers

This Rain Bird Emitter Tubing works like a soaker hose - only better! It waters evenly, won't clog and can be connected to your faucet, garden hose or existing underground sprinkler heads (additional connectors may be needed. 1/2" couplings sold separately,).

Item #	Description	Price
163176	1/4" Emitter Tubing 50'L	\$13.99
163182	1/2" Barbed Coupling, pkg of 4	\$2.49
163175	1/2" Emitter Tubing 100'L	\$28.99
163179	1/4" Barbed Coupling, pkg of 10	\$5.29



Heavy-Duty Aluminum Wind Sock Kits

Set up this durable wind sock in the field in minutes

Highly visible, UV resistant wind socks are very durable and include a corrosion-resistant aluminum frame. Socks are made of PVC-coated nylon and are double-stitched at all seams. Socks mount quickly to the frames using the preinstalled brass frommets and cable ties (included). Frame mounts to a 1-1/4"O.D. pipe (not included).

Item #	Diameter	Length	Price
167914	18"	48"	\$104.99
167915	18"	96"	\$119.99
167913	10"	36"	\$92.99



4'L, 18"-dia.-Throat Wind Sock Replacement

Highly visible, UV-resistant windsock is very durable and fits any standard wind sock frame. Made of PVC-coated nylon and is double-stitched at all seams.

Sock Length: 4'

Throat Diameter: 18"

Item #	Diameter	Length	Price
167916	10"	36"	\$40.99
167917	18"	48"	\$48.99
167918	18"	96"	\$64.99

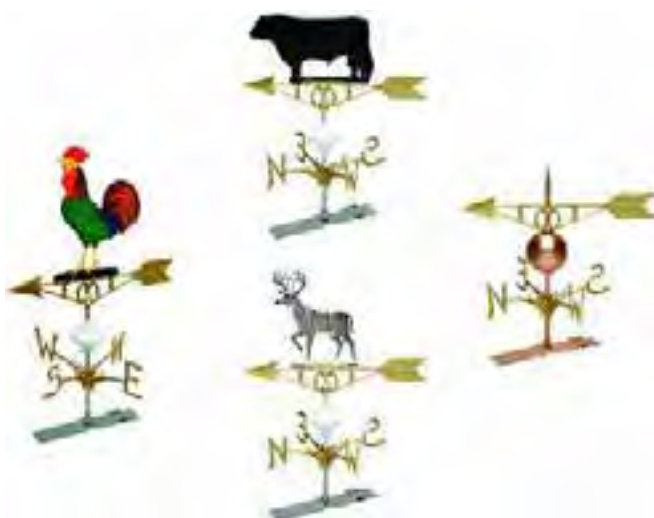

Heavy-Duty Cast Aluminum Weather Vanes

You will not find a weather vane as heavy-duty as this rooster weather vane in any "box store"

Monitor wind direction in style with these attractive hand-painted weather vanes. The aluminum parts are strong and will never rust. They feature realistic ornaments, 19"L gold-painted arrows, unbreakable plastic spacers and a gold-painted compass set. each include a universal mounting bracket that fits roofs of any angle. Weighs 5 lb.

NOTE: It is recommended that all weather vanes be properly grounded.

Item #	Description	Price
151207	Rooster	\$132.99
167620	Deer	\$132.99
167614	Bull	\$132.99
167622	Antique	\$139.99



Kestrel®
Pocket Weather Meters

Accurate and reliable results



Kestrel 1000 Wind Meter

Accurately monitors wind conditions

Protect yourself from spray drift complaints by knowing the wind speed when you spray. This handheld, easy-to-use wind meter is lightweight and durable. Compact unit is your tractor or spray rig to monitor wind conditions. Waterproof and drop proof to 5'. The water resistant is 0.6 to 85 mph (0.2 to 35 m/s) and carried out in ft, m/s, mph, ft/min and mph.

Item #	Price
125013	\$86.99

Kestrel 2000 Wind Meter

Measures temperature, wind speed and wind chill

Take easy, accurate readings of environmental conditions wherever you need them. Similar to the Kestrel 1000, but also reads temperature and wind chill with the push of a button. Backlit display. Measures temperature from -20° to 130°F and wind chill from -20° to 50°F (-4° to 8°).

Item #	Price
125014	\$109.99

Kestrel 2500 Wind Meter

Tracks air pressure, trends and altitude

Building on the Kestrel 2000, air barometric water vapor sensor adds a pressure sensor and altitude. 3.5" air pressure level indicator sensor hanging weather vane and helps you predict fish and wildlife activity. Plus, you get the correction when and temperature readings apply in the palm of your hand. Backlit display.

Item #	Price
125140	\$154.99

Kestrel 3000 Wind Meter

Displays humidity, dew point and heat index

Handheld easy-to-use portable weather station is lightweight and durable. Similar to the Kestrel 2000, but it also measures humidity, dew point and the heat index. Backlit display. Measures relative humidity 0% to 100%, dew point temperature -30°F and heat index -30°F.

Item #	Price
125015	\$154.99

Kestrel 3500 Wind Meter

Keeps tabs on critical environmental conditions

Portable device provides instant access to barometric pressure, heat stress index, wet bulb temperature and altitude data, plus, the same great features of the Kestrel 3000. This pocket meter is an invaluable tool for monitoring the effectiveness of your irrigation methods, reducing your water bills your irrigation system without blowing away or evaporating.

Item #	Price
125141	\$199.99

replacement, impact and non-replaceable battery provided with each meter on the page.

	Kestrel 1000		Kestrel 2000		Kestrel 2500		Kestrel 3000		Kestrel 3500	
Item #	125013*		125014*		125140*		125015*		125141*	
Measurements	Range	Accuracy	Range	Accuracy	Range	Accuracy	Range	Accuracy	Range	Accuracy
Wind Speed	0.2 to 85 mph	±1.0%	0.2 to 85 mph	±1.0%	0.2 to 85 mph	±1.0%	0.2 to 85 mph	±1.0%	0.2 to 85 mph	±1.0%
Temperature			-20° to 130°F (-28° to 55°C)	±1.0%	-20° to 130°F (-28° to 55°C)	±1.0%	-20° to 130°F (-28° to 55°C)	±1.0%	-20° to 130°F (-28° to 55°C)	±1.0%
Wind Chill			-20° to 50°F	±1.5%	-20° to 50°F	±1.5%	-20° to 50°F	±1.5%	-20° to 50°F	±1.5%
Dew Point					-20°	±2%	-20° to 130°F	±2%	-20° to 130°F	±2%
Heat Index							-20° to 130°F	±1%	-20° to 130°F	±1%
Relative Humidity							0 to 100%	±2% (0 to 50%) ±1% (50 to 100%)	0 to 100%	±2% (0 to 50%) ±1% (50 to 100%)
Barometric Pressure					29.1	±0.02" Hg			29.1	±0.02" Hg
Altitude					0 to 200'	±4'			0 to 200'	±4'

*Requires correct operating procedure (NO) requirements. Additional shipping charges will apply. Cannot be repaired by us.



Speed Read Temperatures with Digital Probes

Get soil temperature readings in seconds with this Digital Probe Thermometer

Needle thermometers with stainless probe, pocket clip and protective case give you accurate readings in second. Check soil temperatures for seed germination or monitor fruit and vegetable internal temperatures. Use these rugged temperature probes anywhere you need a quick, accurate reading. **Note:**RTC8 only reads in °F.

Item #	Temperature Range (F)	Probe Length	Price
71113	-40° to 302°F	4.7"	\$16.99
RTC8	-58° to 302°F	8"	\$28.99



EXTECH Mini Infrared Thermometers

Mini infrared thermometer gives fast and accurate surface temperatures

Extech mini IR thermometers are loaded with convenient options that deliver fast and accurate temperature readings at a distance.

Small size and lightweight design make it comfortable and eliminates hand fatigue on large jobs. It features laser pointer, backlit display, automatic data hold when the trigger is released and auto power off to conserve battery life. Choose from four different models. 9V battery and carrying case included.



Dial Probe Thermometers

Dial Probe Thermometer is great for soil and hard-to-reach spots

Monitor soil temperature for planting, irrigation, seed germination and compost piles. Choose the probe that best suits your application.

Item #	Increments	Temperature Range (F)	Probe Length	Probe Diameter	Price
127525	2°	0° to 220°F	8"	2"	\$15.99
127526	2°	0° to 220°F	20"	2"	\$22.99
226099	2°	-40° to 160°F	5"	1"	\$7.99



11"-Capacity Professional Rain Gauge

This Tenite 11"-Capacity Professional Rain Gauge is a professional-quality meteorologist's rain gauge

The entire Tenite Professional Rain Gauge is clear, weather-resistant plastic, graduated to .01". Overflow slot holds up to 11" of rainfall. Comes with mounting hardware and one year's worth of record-keeping sheets. 14"L 4-1/8"dia. opening.

Item #	Price
R25103	\$36.99



LaMotte Tapered Rain Gauge

Stay up-to-the-minute on local weather with this tapered rain gauge that measures rainfall from 0.1" to 5-1/2"

This durable, clear acrylic Tapered Rain Gauge can be mounted with the included 6"L ground stake or mounted on a post or fence. Tapered for a secure fit. 10"L with a 1-1/4"-dia. opening.

Item #	Price
85406	\$17.99



Magnifying Rain Gauge, 5"-Capacity

This easy-to-read Magnifying Rain Gauge helps you monitor your watering needs

Say goodbye to those trips out to read the rainfall amount in your rain gauge. This gauge collects rainwater in the tube and magnifies the reading up to 35% so it can be easily read from a distance. Measures up to 5" of rainfall in 1/10" graduations. Built-in mounting stake includes mounting holes for any flat surface or it can be pushed directly into the grounds. 12-1/2"H.

Item #	Price
147656	\$7.89



TAYLOR Clear-Vu™ Rain Gauge

Accurately measure up to 5" of rainfall

This economy Taylor Clear-Vu rain gauge is made of clear, resilient plastic with a 2"-dia. collector opening. Includes mounting bracket, instructions and chart. 11-7/8"L.

Item #	Price
R25102	\$18.59



Rain Gauge and Thermometer

An easy way to monitor rainfall and temperature from one location

There's no need to install a new post for this rain gauge and thermometer combination. It already includes a 48"H metal mounting post for quick installation and removal. Both the thermometer and rain gauge are mounted to the metal post with swivel brackets so they can be turned in any direction. The dual-scale 15" thermometer measures from -40° to 120°F (-40° to 50°C) in bold, easy-to-read numbers. The 12" dual-scale rain gauge measures up to 7-1/2" (190 mm) of rainfall in 1/16" and 0.1mm graduations. The sturdy metal mounting post can be disassembled into three pieces for easy storage. Note: not for sale in (AL;GA).

Item #	HM	Price
147654	▲	\$15.99

▲ Requires special handling due to DOT regulations. Additional shipping charges will apply. Cannot be shipped by air.



DAVIS **Vantage Vue™ Wireless Weather Station**

Keep an eye on Mother Nature

Keep track of indoor and outdoor temperature and humidity, barometric pressure, wind speed and direction, rainfall and more. Station consists of an integrated sensor suite with sealed electronics and a console with a glow in the dark keypad. Spread-spectrum radio transmission allows the sensor suite to be mounted up to 1000' away from the console. Features a 0.5W solar panel that energizes during the day and provides power at night--includes 3V lithium battery. Console includes an AC power adapter with (3) C battery backup (not included). Radio-compatible with the Davis Vantage Pro2. NOTE: Not for sale in Alaska, Hawaii, U.S. Territories or International. NOTE: Cannot be shipped by air.

Item #	Description	Price
172591	Weather Station	\$399.99
134475	Mounting Pole	\$40.99



DAVIS **Vantage Pro2™ Weather Stations**

Multiple frequency hopping reduces potential interference. Both the wireless and cabled versions come with a digital LCD readout console and integrated sensor suite software package. Integrated suite software includes a rain collector, temperature and humidity sensors, anemometer with 40' of cable and mounting hardware all in one package. Rain collector has a self emptying tipping bucket for exceptional accuracy. Aluminum-plated for corrosion resistance. Anemometer includes both wind speed and wind direction sensors that can stand up to hurricane force winds.

Item #	Description	Price
125095	Cabled Station	\$509.99
125094	Wireless Station	\$604.99

Create a shaded environment for plants & animals



USES:

- Shade trees (like pizza)
- Shade windows and porches
- Shade work areas
- Cover open fields
- Fall protection
- Pest control
- Temporary covering

BENEFITS:

- Easy to remove
- Reduces moisture loss
- Reduces water evaporation and drainage
- Different shades that meet your needs
- Light weight easy to hang
- Durable material
- Wide range of colors and textures

KNITTED SHADE CLOTH

High-density polyethylene cloth is both effective and low cost. Reduces UV penetration, and the chemical-resistant material has better strength, ventilation and water permeability than woven shade fabrics. 20 to 35% lighter than woven shade cloths, but it is easy to install, roll up and store. Plus, it puts less stress on the support structure. Knitted mesh can be used without unrolling, does not require taping.



SHADE CLOTH GROMMETS



IDEAL FOR:

- Shade cloth
- Greenhouse covers
- Covers
- Tarps
- Ag film

SHARK BITE® GROMMET

The most versatile grommet we've found

Unique two-piece grommet features extremely locking protruding teeth to hold & retain all materials including shade cloth, greenhouse plastic, tarp and tarps.

Two-piece design makes this grommet reusable, which will save you money. Material is sandwiched between the two plastic flasks. Small teeth grip the material and don't let go. Features a 2" hole for rope, wire or cable ties.

Item #	Qty./Pkg.	Price
160360	50	\$28.99



HINGED GROMMETS

Hold shade cloth securely and simplify installation jobs

Affordable plastic grommets have interlocking teeth that bite down and hold shade cloth in place. Once hooked, they are on for good. Simply run up to 1/2" dia rope through the channel in the grommet. Extremely strong and durable.

Item #	Qty./Pkg.	Price
127727	50	\$17.99

Item #	Shade		12' x 30'	12' x 20'	12' x 30'	12' x 75'	12' x 100'	20' x 10'	20' x 20'	20' x 30'	20' x 75'	20' x 100'
	Percent	Color										
127656	50	Black	\$20.99	\$42.99	\$105.99	\$144.99	\$194.99	\$34.99	\$73.99	\$177.99	\$219.99	\$325.99
127657	60	Black	\$22.99	\$43.99	\$107.99	\$148.99	\$215.99	\$39.99	\$78.99	\$196.99	\$240.99	\$330.99
127658	70	Black	\$23.99	\$44.99	\$109.99	\$150.99	\$227.99	\$45.99	\$85.99	\$215.99	\$250.99	\$335.99
127659	80	Black	\$30.99	\$56.99	\$139.99	\$190.99	\$254.99	\$50.99	\$93.99	\$232.99	\$318.99	\$460.99
151005	80	White	\$27.99	\$53.99	\$132.99	\$190.99	\$249.99	\$24.84	\$88.99	\$129.95	\$308.99	\$409.99
151006	90	White	\$34.99	\$69.99	\$175.99	\$240.99	\$329.99	\$58.99	\$119.99	\$299.99	\$409.99	\$349.60
145665	70	Teal	\$43.99	\$84.99	\$204.99	\$299.99	\$379.99					
145666	70	Forest Green	\$27.99	\$53.99	\$129.99	\$189.99	\$247.99					

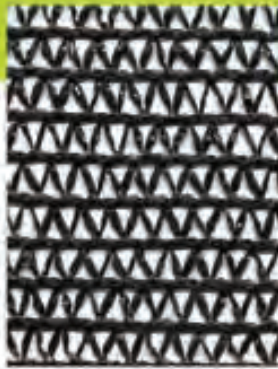

50% Light Blockage

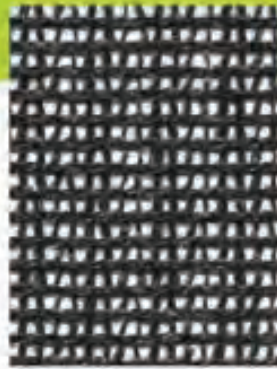

60% Light Blockage



70% Light Blockage



80% Light Blockage



70% Light Blockage



70% Light Blockage

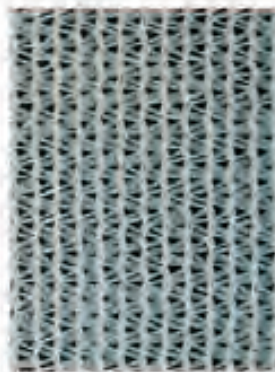

50% Light Blockage

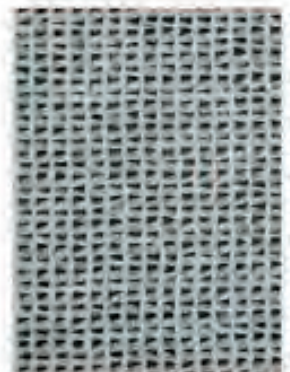

40% Light Blockage

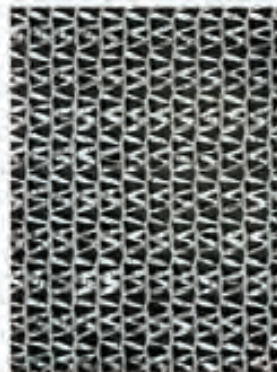

40% Light Blockage



50% Light Blockage

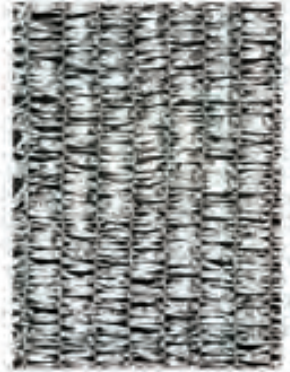

60% Light Blockage

Aluminet® Shade Cloth

Does not absorb heat like standard shade cloth

Aluminet® is a special, knitted cloth made from metalized HDPE and covered with an anti-oxidation coating. It shades like regular shade cloth, but also helps cool because of the high reflective characteristics. Ideal option for covering greenhouses and retail garden centers. Also used as frost protection over vegetable crops. Lighter weight than standard shade cloth.

Item #	Shade Percent	7' x 10'	7' x 20'	7' x 100'	14' x 50'	14' x 20'	28' x 20'	28' x 50'	28' x 75'
151007	40	\$29.99	-	\$275.99	-	-	-	-	-
151009	50	-	\$62.99	-	\$62.99	-	-	-	-
151010	60	\$33.99	\$64.99	-	\$64.99	\$129.99	\$259.99	\$649.99	\$899.99



MANPLOW Wishbone

Pushes or throws snow, customizes to right or left-handers - and still gives your back a break from heavy lifting!

This revolutionary new product was tested by long-time MANPLOW users during the 2017-2018 snow season, and they loved it. It does things the original MANPLOW can't: pushes or throws snow, and assembles for either right or left-handers. And, features MANPLOW's Revolution Blade - when the bottom edge is worn, simply rotate the blade bottom to top for twice the wear. Assembled weight: 24" - 1.9 lbs., 32" - 2.25 lbs., 42" - 2.75 lbs. Handle length 54".

Item #	Price
WB24	\$49.00
WB32	\$59.00
WB42	\$69.00



MANPLOW Revolution Snow Shovels

Get twice the life out of the blades

Shoveling is hard on blades. When they wear out, you usually need to replace the whole thing. Not anymore. The Manplow® Revolution snow shovels feature two edges. When one edge is worn, just rotate the entire blade 180° and it's like brand new. Made of ballistic-rated polyethylene, blades are impact resistant and extremely durable. Steel U-handles. Available with a 32"W, 42"W, 52"W and 62"W blade.

Item #	FO	Price
230196	■	\$58.99
230195	■	\$68.99
230194	■	\$88.99
230193	■	\$98.99

■ Oversize item: additional shipping charges will apply.



SNOWEX Rotary Broom Sweeper with Plow

Make large snow-clearing jobs easier than ever

This SnowEx Rotary Broom Sweeper with Plow makes large snow-clearing jobs easier than ever. A brush cover helps reduce unnecessary wear and tear.

Item #	Width	FT	Price
226781	40"	*	\$4,449.60

* Item ships by Truck due to size and weight.



Premiere Ice Melters

No more chipping ice off your sidewalks or driveways in cold weather

An ideal choice for areas where soild deicers may cause a slipping hazard or areas where calcium chloride-based deicers can cause costly corrosive damage. Non-calcium-chloride based formula is ready to use and inhibits metal corrosion. Effective to -8°F and can be applied with a backpack, handheld or other sprayer. Can be used as a pre-wetting agent on road salts to increase performance at low temperatures. Use 1 to 3 gal. per 1,000 sq. ft. for ice removal or 1.25 gal. per 100 lb. of road salt for pre-wetting.

Item #	Size	Effective Temperature	FO	Price
226283	5 gal. Pail	-8°F	■	\$99.99

■ Oversize item: additional shipping charges will apply.



Ice Melt Crystals

No more chipping ice off your sidewalks or driveways in cold weather

Act quickly and effectively to melt snow and ice even under extreme conditions. Provide a slip-resistant surface on sidewalks, driveways, loading docks, parking lots and other exposed areas. When applied as directed, Premiere ice melters are safer for vegetation than calcium-chloride based deicers and will not harm lawns, trees, shrubs or other vegetation. Will not stain carpets, floors or damage shoes.

NOTE: Do not use on concrete less than one year old.

Item #	Size	Effective Temperature	FO	Price
226278	50 lb. Box	-8°F	■	\$22.79
226279	50 lb. Box	-20°F	■	\$27.99

■ Oversize item: additional shipping charges will apply.



Diamond Crystal® Winter Melt® Ice Melter

Ice melter from Diamond Crystal effectively melts ice down to 5°F

Small crystals melt ice on contact. Large crystals provide longevity and instant traction. 100% sodium chloride Winter Melt formula works best at 5°F and above. Leaves no oily residue. 50-lb. bag.

Item #	Size	Effective Temperature	FO	Price
224140	50-lb. Bag	5°F	■	\$13.99

■ Oversize item: additional shipping charges will apply.



Calcium Chloride Ice Melter

High-powered calcium chloride melts snow and ice 2-5 times faster than rock salt or blended ice melters and requires fewer applications

High-powered de-icing pellets are capable of melting snow and ice 2 to 5x faster than rock salt or blended ice melters and require fewer applitons. Pellets are odorless and colorless, leaving no powdery residue. Safe on concrete and vegetation when used correctly. Melts ice down to -25°F.

Item #	Size	Effective Temperature	FO	Price
224143	50 lb. Bag	-25°F	■	\$33.99

■ Oversize item: additional shipping charges will apply.



Industrial Strength Ice Melter

Get quick ice relief with magnesium chloride pellets that melt ice faster, longer and at lower temperatures than crystals or granules

Melt ice and snow immediately upon contact. Contains calcium chloride and magnesium chloride pellets and sodium chloride. Pellets melt ice faster, longer and at lower temperatures than crystals or granules. Melts ice down to -15°F.

Item #	Size	Effective Temperature	FO	Price
224142	50 lb. Bag	-15°F	■	\$16.99

■ Oversize item: additional shipping charges will apply.



Pest Management Supplies

Sure, we all laugh at “Caddyshack,” every time we see it, but there’s nothing funny when insect or animal pests are feasting on your crops or tearing up your property. We carry everything you need to protect against destructive critters: repellents, barriers, decoys and much more. Whatever your problem — just call us at 1-800-382-8473 and we’ll help you figure out the right solution.



GopherHawk® Mole and Gopher Trap with Wedge-and-Probe Tool
226427 on pg. 294



RAMPAGE Bait Chunx® Rat and Mice Bait
211684 on pg. 296



Liquid Fence® Deer and Rabbit Repellent, 2.5-gal. Concentrate
145939 on pg. 287

TENAX®

BIRD-X 

BIRD•B•GONE® Inc.

TOP BRANDS

MOTOMCO

VICTOR

DEER STOPPER

LIQUID FENCE® 

Bird & Small Animal Control.....278-284
Netting & Fencing.....285-286
Animal Repellents & Live Traps..... 287-291

Rodent Control..... 292-298
Snake Chaps & Repellents..... 299
Insect Control 300-306



Quadblaster Electronic Bird Repeller

Chase away overhead bird infestations with sound waves that are inaudible to the human ear

Stop nuisance bird infestations and unsightly droppings from semi-enclosed or enclosed areas safely and quietly. Ideal for barns, storage sheds, warehouses, garages and other indoor areas where roosting is a problem. Four internal speakers generate overlapping UHF sound waves that create an irritating environment, making it difficult for birds to stay, yet is silent to humans. To maximize effectiveness, the speakers can be adjusted to run at a constant 20 kHz, "warble" from 20-30 kHz or alternate between a constant and warble output in 12-sec. bursts. Plugs into any 110V AC outlet and conveniently mounts in any direction or on any plane with screws, nails, wires or adhesives (not included).
 NOTE: Risk of hearing damage with extended exposure at a distance of less than 10'. Do not place near a location where employees spend an entire work shift.

Item #	Price
84469	\$555.99



Bird Chase Super Sonic Sound Deterrent

Bird-B-Gone Bird Chase Super Sonic Sound Deterrent scares off nuisance birds from your property

Weatherproof system broadcasts distress and predator calls every 10 min. from more than 22 different bird species. When birds hear the calls, their natural instinct is to flee. Program the unit to scare specific birds away from large, open spaces. It also has a general setting to scare off multiple bird species. LCD panel shows the status and user settings. Safe for use around pets. Attach additional speakers (198212) to cover larger areas.

Item #	Type	Price
198209	1 Speaker	\$114.99
198210	2 Speaker	\$174.99
198211	4 Speaker	\$230.00
198212		\$59.99



Pistol-Launched Pyrotechnics

Single-shot pistol uses pyrotechnics to scare off nuisance birds and wildlife from your crops, marinas, fish farms and feedlots

Protect your property from bird damage. Frighten birds with two types of pyrotechnics: Screamer Sirens and Bird Bangers. Both are fired from either the single- or double-shot launchers. No ATF permit required. 100 blank charges are included with each pyrotechnic. Additional packages of blank charges sold separately. **Screamer Sirens** – Issue a 100dB siren-like sound as birds fly toward the target. **Bird Bangers** – Explode with a loud 90dB report down range. NOTE: This product CANNOT be shipped by air. Cannot be sold or shipped to Alaska, Hawaii, New Jersey, Oregon, U.S. Territories or International. Note: not for sale in (AL;GA;OH;MS).

Item #	Description	HM	Price
RBLNK	Additional Blanks, Pkg of 100	▲	\$16.99
RA15	15mm Single-Shot Launcher		\$52.99
RA25	15mm Double-Shot Launcher		\$58.99
RASS	Screamer Sirens, Pkg of 100	▲	\$83.99
217801	Bird Bangers, Pkg of 100	▲	\$83.99

▲ Requires special handling due to DOT regulations. Additional shipping charges will apply. Cannot be shipped by air.

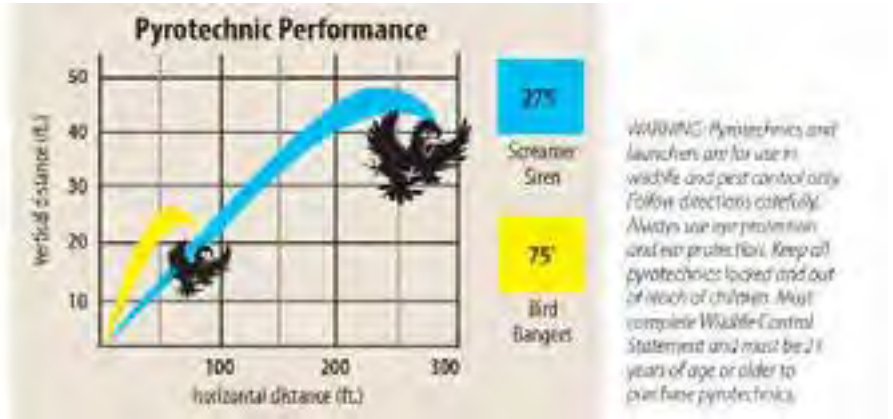

M4 Single-Detonation Cannon

The M4 Pest Control Single-Detonation Cannon repels nuisance birds and wildlife with a loud "thunderclap"

Rugged systems deliver a harmless, "thunderclap" equivalent to a 37mm cannon (130dB). Do not require electricity or a battery to operate, but run on a single 5-gal. LP cylinder (not included). Optional revolving platform rotates cannon 360°. **M4** – Fires at a regular interval, user set from 30 sec. to 20 min. Operates 14 days at a 20-min. firing interval on 5-gal. LP (not included). **M8** – Fires at an irregular interval, approximately three times in 25 seconds, followed by four detonations in one minute. Operates 10 days on 5-gal. LP (not included). **Rotomat Revolving Platform** – Moves the cannon's direction of fire in a complete 360° rotation, about 90° at each detonation. Does not require a power source and does not consume additional LP.

Item #	Description	Price
RABRP	Rotomat Revolving Platform	\$365.99
RABM4	M4 Single Detonation Cannon	\$487.99
RABM8	M8 Multiple Detonation Cannon	\$503.99



Solar-Powered Owl Decoy with Rotating Head

Replica great horned owl is designed with a predatory pose to scare off birds and other small pests. Hand-painted for realism, with surprisingly lifelike predatory features. Timed, solar-powered head movement appears natural. No batteries required. Made from recycled materials.

Item #	Price
221414	\$45.99



Owl with Rotating Head

Scare off birds and pests

Realistic owl frightens birds and other pests away. Owl's head moves in gentle breezes to give this replica a lifelike look. Fill plastic body with sand, dirt or cat litter to anchor in place.

Item #	Price
G73500	\$23.99



Horned Owl Decoy

This lifelike Horned Owl Decoy frightens away pesky wildlife

Mount this great horned owl replica on a post or building edge to scare your pests away. Large eyes and realistic features keep problem birds from coming around. Fill plastic body with sand or water to anchor in place.

Item #	Price
RD300	\$15.99



Hawk Decoy

This realistic hawk decoy naturally repels pests like birds, rabbits, squirrels and snakes away from your property

Hawk decoys can be effective tools to repel pests because they are natural predators that hunt during the day. Unlike owls, which usually hunt at night, hawks can be an effective daytime repellent against birds, rabbits, squirrels, snakes and other small animals. Realistic plastic decoy can easily be mounted to any flat surface by filling with sand or hung by using the eyelet on the head. Move decoy periodically to increase effectiveness and use along with other deterrent methods.

Item #	Price
167715	\$15.49



Three-Dimensional Fox Decoy

So realistic it scares off geese and small animals

Lifelike fox offers a simple, humane solution to keep geese, ducks, rabbits, skunks and rodents away from your property. Center stake design allows the portable decoy to move with the slightest breeze. Bushy fur tail adds even more motion. Move the decoy occasionally for maximum control. Provides up to one-acre coverage. Compact, two-piece stake makes it easy to set up and take down. Leave fox in the sun or blow dry the decoy to give it a natural shape.

Item #	Price
198331	\$61.99



Peregrine Falcon Decoy

Falcon decoy with realistic, hand-painted detail

Peregrine Falcon Decoy helps protect gardens and fruits/vegetables from birds and other pests. To use, simply fill falcon with sand or gravel, drive a pole firmly into the ground and mount falcon on top. For optimum effectiveness, move it around the garden every few days. 15"H.

Item #	Price
226374	\$16.99



Flambeau Coyote Decoy

Keep geese away from golf greens, sports fields, lawns and more

Popular choice for keeping geese away. Removable legs attached with a bungee cord system allow decoy to be placed either sitting or lying. Realistic faux fur tail moves in the wind. 36"L x 12"W x 25.5"H.

NOTE: Decoy might need to be staked or weighted with sand in windy areas.

Item #	Price
163156	\$92.99



Prowler Owl Decoy Bird Repeller

Prowler Owl Bird Repeller has a hunting posture and moves to scare birds away

This realistic-looking aerial predator is life-size and has a wing span of nearly 4'. Wind through the airfoil causes the wings to fl ap and the head and tail to rise and fall. Frequent movements prevent birds and small animals from becoming accustomed to it, making the owl an effective long-term repellent. Mount neck opening on a 1/2"-dia. pole (not included) or suspend with string.

Item #	Price
84465	\$49.99



Goose and Duck Repellent, 1-qt. Concentrate

Get rid of messy geese for good with the unique formula of Goose Stopper Repellent

This unique blend of whole egg solids and mint and rosemary oils creates a taste and feel in turf grasses that geese will avoid. Apply once, then immediately upon return of geese .

Note: not for sale in (CA;DC;IN;KS;NC;OK).

Item #	Description	Price
145543	1-gal. Jug	\$124.99
145541	1-qt. Bottle	\$35.99
145542	1-qt Hose End	\$39.99



3-D Predator Coyote Decoy

Rid your property of messy, disease-carrying geese with this realistic, life-sized, 3-D Predator Coyote Decoy

3-D feature allows for 360° coverage. Realistic furry tail moves in the breeze. Easy to set up and is secured to the ground with a sturdy, plastic stake. Move periodically to increase effectiveness. Multiple decoys may be needed for large areas. 37"L x 8"W x 16"H.

NOTE: Decoy is rolled up when boxed for shipment. Needs to be set up in direct sunlight for a few hours to return to original shape.

Item #	Price
148034	\$49.99



Floating Alligator Head

Scare off geese, ducks and other waterfowl

This realistic, life-sized floating replica of an alligator head is perfect for any water area infested by birds. Ideal for golf courses, parks, fish and shrimp farms, and even residential pools. The 25"L x 11"W x 7"H head moves realistically with the wind and water, and the mirror-backed eyes flash in the sun. Covers one acre. Durable weatherproof urethane foam with UV coating. Includes anchor hook on bottom. Effective anywhere as this is an instinctive fear, not a learned one.

Item #	Price
G70201	\$59.99



NEW

Pond Defender - 12 Pack

MMPOND-12PK

Bird B Gone Pond Defenders are UV protected interlocking polypropylene plastic discs that float just below the surface of your pond or water garden, creating a shelter for pond fish like KOI against predators. The Pond Defender Set consists of 12 discs that interlock together in seconds to fit the shape of any pond.

Item #	Price
MMPOND-12PK	\$29.99



NEW

Solar Bird Repeller

RPLR-SLR1

Uses continuous motion to prevent large pest birds from landing. Has two 2.5 foot long arms mounted on top of the unit that spin continuously. Includes two AA rechargeable batteries that store enough power to keep the unit spinning throughout the night. Easy to mount, and can be mounted to flat or angled surfaces.

Item #	Price
RPLR-SLR1	\$89.99



NEW

Bird Spider 360 - 2 Ft W/ Pvc Base And Screws - Spinnable

Bird B Gone Bird Spider 360 is a humane stand-alone physical bird deterrent that is used to scare large birds away from concentrated areas. Pre-assembled, easy to install, and can be used in a variety of settings. Made of stainless steel attached to a UV protected polycarbonate base.

Item #	Description	Price
BSBB	Canvas Sand Bag	\$34.99
BS200SPN	2 Ft	\$39.99
BS400SPN	4Ft W	\$44.99
BS600SPN	6Ft W	\$49.99

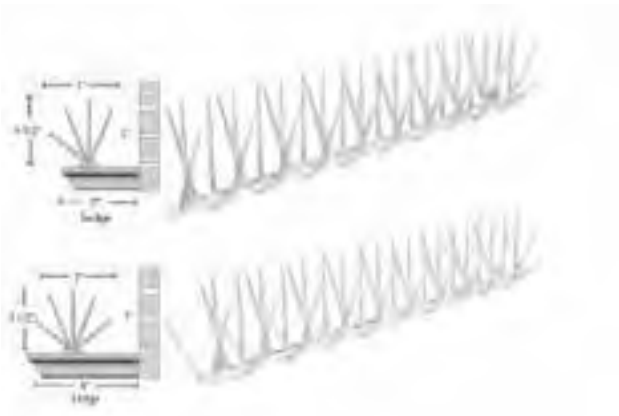

Polycarbonate Bird Spikes

Clear Polycarbonate Bird Spikes repel all species of birds

Repel all species of birds with these durable spikes. Ideal for ledges, windowsills, beams, roofs, and even. Attach 2'L sections to wood with No. 8 wood screws, or attach to concrete, brick or steel with construction adhesive. Total length is made up of 2'L sections. Item #s 160368 and 160369 are 10' long, clear. For Item # 160370, specify color: brick red or clear for this 50' long spike.

Item #	Width	Length	Price
160368	5"	10'	\$29.99
160369	7"	10'	\$32.99

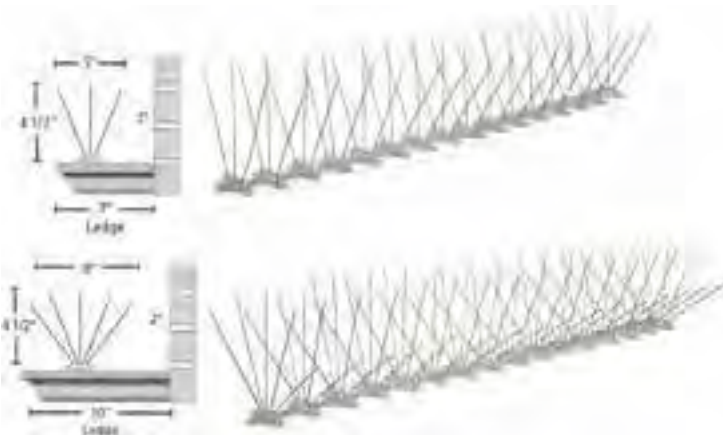

Stainless Steel Bird Spikes, 50'L x 8"W

Long-lasting, maintenance-free stainless steel/polycarbonate spikes are an economical choice to get rid of pest birds. Each come in 2'L sections. Mount sections on flat, curved or irregular surfaces with wood screws or adhesive. 160372 and 160373 are 10', 160375 is 50'.

Item #	Width	Length	Price
160375	8"	50'	\$259.99
160372	5"	10'	\$44.99
160373	8"	10'	\$49.99



Bird Lite

One-million-candlepower bulb sends out intense white, red and blue light at 75 flashes per minute to disorient and repel pigeons and other nuisance birds. The light is barely noticeable by people on the ground when installed at heights where birds normally roost. For use in warehouses, hangars, sheds or any large, dimly lit area where birds create a nuisance. Covers up to 10,000 sq. ft.

Item #	Price
125999	\$269.99



Bird Spider™ Bird Roosting Deterrent, 8'-dia.

This ingenious bird repellent has stainless steel "arms" that move with the breeze to keep birds from landing and roosting. 8"-dia. unit can be mounted with the included 4" x 4" PVC base and may be installed in a row. Arm tips should overhang the mounting surface by at least 2".

Item #	FO	Price
151331	■	\$49.99

■ Oversize item: additional shipping charges will apply.



TEBAX Ortoflex Bird Netting

Ortoflex Bird Netting protects your valuable crops from nuisance birds and other pests

Effective, humane solution for protecting individual trees, shrubs, and small gardens from nuisance birds and pests. Polypropylene netting is lightweight, easy to cut, durable, UV-stabilized and reusable. May be used in vertical, horizontal or diagonal applications. 6.5' wide rolls have 3/8" x 3/8" mesh size. Typical lifespan is 3 to 4 years. Green color.

Item #	Length	Price
217592	15'	\$4.99
217593	30'	\$9.99



Predator Eye Diverter

Reflective surface confuses and frightens away birds

The shiny, reflective surface and mock predator eye frighten and confuse birds so they avoid the area. Ideal for repelling birds on fruit trees, homes, patios and boats. Feature a 360° swiveling, hanging loop so diverters rotate for added realism. Use twine, string or rope to hang diverters at varying heights, about 2 to 3' apart. Package of 5.

Item #	Price
218032	\$13.49



Bird Scare Flash Tape

A cost-effective way to scare off pesky birds

Tape moves with the wind creating a visual and audio distraction zone birds will avoid. For best results, cut into strips and distribute throughout the area you want protected. 50'L x 1"W.

Item #	Price
230687	\$3.99



Scare Eye Balloon for Bird Control

Keep birds away from your crops with Scare Eye Balloon for Bird Control

Scare birds fast with these easy-to-use, 18"-dia. balloons. Mylar® tails and "eyes" mimic and exaggerate the glaring eyes and gaping mouth of a predator bird. We recommend four to eight balloons per acre. Fill with air and hang 3' above your crop. Pole not included. We recommend electrical conduit. Rotate colors for best results. Specify color: black, white or yellow.

NOTE: Pole not included. We recommend electrical conduit.

Item #	Price
TEB	\$10.99



TENAX® C-FLEX Light Deer Fencing

Protect your landscaping from wildlife

Long-lasting polypropylene fencing makes protecting your landscape from wildlife damage easier. Economical solution for areas with less deer traffic. 1-3/4" x 2" mesh allows optimal visibility and lets light pass through. Reusable. Black color.

Item #	Size	Height	Length	FO	FT	Price
G51923	7.5' X 100'	7-1/2'	100'	■		\$119.99
G51924	7.5' X 330'	7-1/2'	330'		*	\$299.99
G51925	10' X 330'	10'	330'		*	\$339.99

- *Item ships by Truck due to size and weight.
- Oversize item: additional shipping charges will apply.



TENAX® Plant and Pond Protection Netting

Stop wildlife from damaging your crops or plants

Create an all-purpose barrier between wildlife pests and your crops with this tough polypropylene 3/4" x 3/4" mesh netting. Can be cut to any size. Invisible from a distance. Perfect for protecting valuable landscape plants. Black color.

Item #	Length	Height	Price
G51907	30'	14'	\$19.99
G51906	100'	7'	\$24.99



Mesh Barrier, 100'L x 7'W Roll

Protects your property from hungry deer, rabbits, raccoons and other wildlife pests

Keeps out deer, rabbits, raccoons and other wildlife pests. UV-stabilized polypropylene resists fading and deterioration from sunlight. Won't cut hands like metal fencing. Easily attaches to trees or posts. For extra insurance, use 10'L posts (not included) and leave 8' of the post above the ground. 7"H x 100'L roll weighs only 6 lbs. for effortless handling. Mesh size 7/8" x 7/8". Black color.

Item #	Price
RLG40	\$79.99



TENAX Medium Duty Poly Fencing

Black Multi-Purpose Fencing keeps birds out

This polypropylene fence outlasts chicken wire. Use it for poultry operations, turkey fencing, small animal pens and garden fencing. 3/4" x 1" aperture blocks out disease-carrying small birds. Easy to install, won't rust or corrode and is resistant to the sun's destructive UV rays. Also used for sport fencing, crop protection from deer and leaf nets for ponds. Black color.

Item #	Size	Height	Length	FO	Price
G51908	2' X 25'	2'	25'		\$17.49
G51909	3' X 25'	3'	25'		\$21.99
G51911	4' X 50'	4'	50'	■	\$35.99

■ Oversize item: additional shipping charges will apply.



TENAX Heavy Duty Poultry Fencing

This Green Poultry Fencing is made of polyethylene material that resists UV rays and will not rust or corrode like traditional chicken wire.

Keep poultry and small animals in pens or out of crops. Smaller hexagonal openings (3/4" x 3/4") and a thicker design than Tenax medium-duty poly fencing. Polyethylene material resists UV rays and will not rust or corrode like traditional chicken wire. Cuts easily with a utility knife and leaves no sharp edges.

Item #	Description	Height	Length	FO	Price
G10824	3' x 25', Black	3'	25'		\$25.99
G10803	3' x 25', Green	3'	25'		\$25.99
10804	4' X 50', Green	4'	50'	■	\$59.99
10825	4' X 50', Black	4'	50'	■	\$59.99



Bulk Cable Ties

Perfect for all of your fastening applications. These nylon zip ties feature finger grips for easy handling and allow the tie to be partially closed without engaging the pawl. One-piece design, transition rails and teeth provide a low insertion force, while maintaining a high-tensile strength. Specify color: black or natural.

Item #	Length	Qty./Pkg.	Price
G51351	5"	1000	\$18.49
G51352	7"	1000	\$27.49
G51353	11"	500	\$30.49
G51354	14"	500	\$35.49
G51350	4"	1000	\$9.99

- Black
- Natural



Automatic Twisting Tool

Heavy-duty galvanized steel construction and a unique spring return action require little effort and eliminate tired wrists from manual twisting. To tie wires, simply insert hook of twister into both tie loops of wire, pull handle and tool automatically twists wire tightly. Knurled handle for a slip-free grip. 11.5"L.

Item #	Price
159871	\$26.49



Deer, Rabbit and Squirrel Repellent

Year round protection from damage due to feeding by deer, rabbits and squirrels. One application lasts up to three months through rain or snow without leaving a residue. Protects plants with a patented dual-action deterrent system of odor and taste. EPA registered for use on grass, plants, trees, bushes, flowers, bulbs and seedlings. Biodegradable all-natural formula will not harm humans, pets or other animals. The OMRI Listed® Seal assures the suitability of products for certified organic production, handling and processing under certain conditions. Ready-to-use covers 750 sq ft. Concentrate covers 2,000 sq ft per 16-oz.

Item #	Description	Price
G71542	128-oz Concentrate	\$154.99
228399	48-oz, RTU	\$16.99
G71540	16-oz Concentrate	\$27.99
G71543	2.5-gal Concentrate	\$279.99



Deer and Rabbit Repellent

Shoo away deer and rabbits from your gardens without using harmful chemicals
Liquid Fence® is one of the most recognized and trusted names in the repellent industry. They're so confident in the effectiveness of their products that they offer a 100% guarantee. Their garlic and whole egg formula produces a scent that deer and rabbits avoid. Dries odorless and will not harm plants or animals. Applications are water-resistant through 4" of rain. Concentrated formula for larger areas/commercial use.
Note: not for sale in (IL,OK).

Item #	Description	Price
145511	1 gal Concentrate	\$119.99
145507	1 qt RTU	\$12.99
145939	2.5 gal Concentrate	\$239.99
145508	1 gal RTU	\$24.99
160348	40 oz Concentrate	\$39.99



Deer & Rabbit Granular Repellent

Liquid Fence Deer & Rabbit Granular Repellent is safe for use on edible crops

Don't let deer or rabbits destroy your lawn, vegetable garden and flower beds. Just sprinkle this biodegradable, eco-friendly repellent on plants that grow up to 24"H to solve your problems with unwanted pests. Long-lasting granular formula protects vegetation even after rainfall. It's easy to use and safe for plants and people.

NOTE: This item cannot be sold in or shipped to Indiana, New Mexico, U.S. Territories or International.
Note: not for sale in (IL,OK).

Item #	Size	Price
193077	2-lb, 1,000 sq ft	\$14.99
212138	40-lb, 20,000 sq ft	\$159.99
193076	5-lb, 2,500 sq ft	\$24.99



Deer Repellent

Keep deer away without the offensive odor of most deer repellents

This concentrated formula (9:1 ratio) utilizes a patented mixture of pleasant-smelling oils along with egg solids that deter deer through sensory confusion instead of foul odors. USDA Certified Organic. Dries clear and will not burn plants or turf. Applications last 30 days and will not wash off in rain.

Item #	Description	Price
145518	1-gal, Concentrate	\$124.99
145514	1-qt, RTU	\$15.99
145515	1-gal, RTU	\$24.99
145517	1-qt, Concentrate	\$39.99



Plotsaver Deer Barrier System

Unlike most deer repellents that require direct application to protect plant material, this unique system keeps deer out of areas by protecting the perimeter and keeping deer at bay. Patented method uses the proven Deer Stopper® organic deer repellent. Plotsaver™ kit (Item # 145520) includes 840'L of 3/4"W ribbon (untreated) and 16 oz. of Deer Stopper concentrate repellent, which is enough to protect one acre for up to three months. To use, string absorbent poly-tape ribbon around the perimeter of plants at 30" off the ground (deer muzzle height), then spray ribbon with Deer Stopper repellent. This creates a physical and sensory barrier that lasts up to 30 days per application (reapply repellent to ribbon approximately every 30 days). Deer Stopper is also available in a pretreated 100'L black ribbon (not shown, Item # 145519) for smaller areas that need protection. 39"L support stakes and ribbon clips sold separately below. USDA Certified Organic.

Item #	Price
145519	\$14.99
167686	\$25.79
145521	\$29.99
145520	\$49.99
145522	\$49.99
145523	\$9.99



Deer Ban Repellent Capsules

Contains 5% coyote urine, giving the impression that one of a deer's most dreaded predators is nearby. Simply put a capsule every 10–20' around the perimeter every 30–90 days. Works year-round. Water activated. Biodegradable and odorless to humans.

NOTE: Not for sale in CA, LA and TX.
Note: not for sale in (AR;KY;TX).

Item #	Qty./Pkg.	Price
224579	20	\$10.99
224581	50	\$17.49
224583	150	\$48.49



Repellex Capsaicin Tablets

Capsaicin (hot pepper) tablets absorbs into plants by growing into their root system, giving them an undesirable taste. Absorbs over the course of 30 days and remains active for a year. No unpleasant odor. Repels just about every critter out there.

Note: not for sale in (AL;AK;AZ;AR;CT;DE;DC;FL;GA;KS;KY;LA;NH;NM;NY;NC;ND;OK;MD;MN;RI;SC;TN;UT;VT;WV;WY).

Item #	Qty./Pkg.	Price
171539	500	\$164.99
171536	50	\$17.99
171537	150	\$49.99
171538	300	\$99.99



Nature's Defense® Organic Animal Repellent, 50 lb.

The safe and simple way to repel unwanted critters

Sprinkle this all-natural granular repellent around the areas you want to protect against deer, rabbits, gophers, raccoons, chipmunks, skunks, mice and other critters. It's safe to use around children, pets and food crops, and won't wash away in the rain, evaporate or freeze.

Item #	Description	FO	Price
193129	22 oz		\$14.99
193131	50 lb.	■	\$181.99

■ Oversize item: additional shipping charges will apply.



Garlic Oil Repellent, Pkg. of 50 Green Dispensers

Reduce wildlife browsing damage on fruit, nut and vegetable crops, and ornamental plants. Place 4–6' apart (closer in more intense areas) to create a barrier around your plants. Apply before feeding habits are established for best results. Each dispenser lasts up to six months. Pkg. of 50.

NOTE: Not for sale in CO, ND, SD, Puerto Rico, Canada or International.
Note: not for sale in (MA;PA;SD).

Item #	Price
G76541	\$30.99



Garlic Barrier Repellent

Helps deter deer, rabbits, field mice, whiteflies, spidermites, leafrollers, leafhoppers, ants, aphids, thrips, grasshoppers, spiders, etc. Simply mix with water and spray on your plants. Dilute quarts in water 10:1. 1 qt. makes enough to cover 10,890 sq. ft. (gallon containers dilute 99:1). OMRI Listed for organic growers.

Note: not for sale in (AL;AZ;HI;IA;KS;KY;NH;MA;WV;WY;AE;AA).

Item #	Description	Price
R42406	1 qt.	\$12.99
R42407	1 gal.	\$87.39



Halt!® Dog Repellent

When sprayed in a dog's face, Halt causes temporary but extreme discomfort to provide protection from dog attacks. Used by the U.S. Postal Service® since 1966. Active ingredient is capsaicin (Item # 620611 contains 0.35% and Item # 620612 contains 1%), which is a naturally occurring extract from peppers. Pressurized spray. EPA registration number is 7754-37.

Note: not for sale in (AL;AR;GA;AE;AA).

Item #	HM	Price
620611	▲	\$4.99
620612	▲	\$6.49

▲ Requires special handling due to DOT regulations. Additional shipping charges will apply. Cannot be shipped by air.



Yard Gard Electronic Animal Repeller

This electronic repeller uses powerful frequencies of 5,000–25,000 Hz to create an annoying environment that animals can't stand to be around. Frequencies adjust to customized settings for particular pests. Effective for deer, raccoons, skunks, opossums, dogs, cats and rodents. Motion sensor with adjustable sensitivity activates the unit when pests are in the area. Operates on (4) C cell batteries (not included) or 120V AC adapter (included). Keyhole slots in back for easy mounting. 6.75"L x 5.25"W x 3.5"D.

Item #	Price
134314	\$61.99



Plantskydd Small Animal Repellent

Plantskydd granules provide up to six months protection over winter and 3–4 months protection during growing season. Safe for use in fruit, vegetables and food crops as well as ornamentals. Active ingredient is dried blood (porcine and/or bovine) and is OMRI listed for organic production. Do not apply directly to edible parts of food crops.

NOTE: Do not apply to edible parts of food crops.

Item #	Size	Price
167676	1-lb, 600 sq ft	\$10.99
167678	7-lb, 4,200 sq ft	\$38.99
167679	20-lb, 12,000 sq ft	\$94.49



PLANTSKYDD Animal Repellent

This ready-to-use animal repellent is used by nurseries, landscapers to protect plants from damage by deer, rabbits, elk and moose. It works by emitting an odor that animals associate with predator activity, repelling the animal before it nibbles on plants. The odor is not unpleasant to the applicator. Provides up to six months protection over winter and 3–4 months protection during growing season. Contains built-in fertilizer to promote plant growth.

NOTE: Cannot be sold or shipped to Canada or International.

Item #	Form	Size	Price
G71952	Powder	2.2 lb.	\$367.99
G71951	Powder	2.2 lb.	\$44.99
G71950	Ready-to-Use	1.3 gal.	\$58.99



Live Trap with Sliding Rear Door

Full-size sliding panel opens quickly for baiting, animal release or to transfer animals to carriers, features double latch and security lock. Heavy-gauge metal for durability.

NOTE: Check with your local wildlife office for pertinent laws and permits.

Item #	Size	FO	FT	Price
72842	18"H x 15"W x 42"L			\$186.99
72848	22"H x 15"W x 48"L	■		\$229.99
72861	28"H x 20"W x 60"L		*	\$435.99
72872	28"H x 20"W x 72"L		*	\$449.99
72818	5"H x 5"W x 18"L			\$50.99
72824	8"H x 7"W x 24"L			\$56.99
72830	12"H x 11"W x 30"L			\$71.99
72836	12"H x 11"W x 36"L			\$79.99



Single-Door Traps

Trap everything from chipmunks to coyotes. Made from heavy-gauge galvanized steel for long life with smoothed inside edges for the protection of the animal. Put bait in back of trap and set the spring-loaded or gravity door.

Item #	Size	FO	Price
RHV42	18"H x 15"W x 42"L		\$164.99
RHV48	22"H x 15"W x 48"L	■	\$210.99
RHV18	5"H x 5"W x 18"L		\$42.99
RHV24	8"H x 5"W x 18"L		\$49.99
RHV32	12"H x 11"W x 30"L		\$68.99
RHV36	12"H x 11"W x 36"L		\$72.99

■ Oversize item: additional shipping charges will apply.

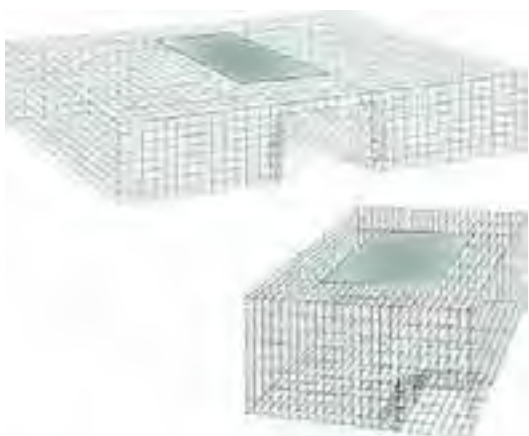

KNESS Commercial-Grade Live Traps for Birds

Spring-loaded door will not open until you unlock it, making the trap virtually escape-proof. Heavy-gauge galvanized steel wire with steel rod reinforcements for long life. Top-mounted door allows for easy bait insertion and bird release. NOTE: Check with your local wildlife office for all pertinent laws and permits.

NOTE: Check with your local wildlife office for all pertinent laws and permits.

Item #	Used For	Price
RHV19	Sparrows	\$47.99
RHV37	Pigeons	\$69.99



VentGuard™ Animal Control Screens

Stop raccoons and other critters from entering through vents with these VentGuards. Heavy gauge expanded metal mesh. Dryer VentGuard can be installed over most 3" or 4" dryer or exhaust vents.

NOTE: Animal control screens should only be installed by qualified roofing or siding contractors.

Item #	Size	FO	Price
163135	16"L x 16"W x 5"H		\$27.99
163139	7"L x 7"W x 4-1/2"H		\$28.49
163136	30"L x 30"W x 12"H	■	\$52.99

■ Oversize item: additional shipping charges will apply.



Solar Mole Repeller

Maintenance-free repeller uses solar power to generate vibrations every 30 seconds that repel moles, voles, gophers, shrews and other burrowing rodents. Chases away destructive rodents in an area up to 7,500 sq. ft. Solar modules keep the unit running even in poor light and at night and reserve power lasts up to five days in darkness. Weather-resistant and waterproof case is included along with a rechargeable AA NiMH battery.

Item #	Price
155670	\$26.99



Sonic Molechaser® Rodent Repeller

Produces an underground penetrating sonic pulse of 300 Hz at 15-sec. intervals which does not affect pets just rodents, covering up to 11,250 sq. ft. Control head can be buried flush with your lawn. The battery cylinder allows you to change the batteries without removing the unit from the soil. Constructed from a single billet of aluminum. 16"L. Uses (4) D batteries (not included).

Item #	Price
G77900	\$24.99



Vibrasonic Molechaser® Rodent Deterrent

The most advanced rodent deterrent available. With a range of 13,500 sq. ft. (1/3 acre), moles, voles, and other destructive burrowing rodents can't hide. A patented motor generates powerful vibrations that chase away rodents without harming them. Constructed of aluminum and made watertight to ensure a lifetime of use. 16"L. Uses (4) D batteries (not included).

Item #	Price
G77906	\$32.99



Moletox II® Mole and Gopher Bait

This exclusive formula pelleted bait has a unique cracked-corn base, making it more palatable to the pests. The quick action of this bait ensures no secondary poisoning. Simply insert the indicated dosage into the active tunnel (optional bait applicator sold separately, Item # 71117). 16-oz. container. Note: not for sale in (AR;DE;IL;ND;MD).

Item #	Price
217727	\$12.99



MOTOMCO Gopher Bait

Easy-to-apply pelleted bait can kill pocket gophers in just a few hours. Simply apply 1 tsp. of bait underground in either a mound opening or in a main runway. Pellets may be used with most bait applicators. NOTE: EPA registration number is 12455-18-3240. Note: not for sale in (ND;MD;MO).

Item #	Price
224078	\$24.99
170996	\$7.99



Bait Applicator for Moles and Gophers

Apply mole and gopher bait without disturbing their tunnels with this easy-to-use, 38"L applicator. Simply fill applicator reservoir with bait. Locate the mole or gopher runway by probing mound until probe drops into a tunnel. Then, turn the handle twice to apply a proper amount of bait.

Item #	Price
71117	\$29.99



GopherHawk  **Extra Trap for GopherHawk Trap**

Get rid of gophers and moles once and for all

Trap and remove gophers and moles once and for all. Use the wedge-and-probe tool to set the trap from above the ground. Yellow catch indicator lets you know when a gopher has sprung the trap. No digging and no need to handle dirt! Trap Only – Expand your kit's coverage area by adding single traps. Does not include probe and wedge tools.

NOTE: Allow time for trap to work. While the trap lets you install without much disturbance to the tunnel, it may take some time for the gopher to return. Do not clean with soap or other cleaner. Gophers are territorial, so when they smell another gopher in their tunnels, they are likely to investigate, hopefully triggering the trap in the process. If clogged, direct a strong spray of water into the opening of the trap to clear obstructions.

Item #	Description	Price
226428	Trap only	\$24.99
226427	Trap with Wedge and Probe Tool	\$32.99



“We have caught many moles with these traps and recommend them to our friends and neighbors...We like to set 2 traps to increase our chances, and have the best luck if we set them at the first sign of tunnels. We often catch the mole the first night!”

—Judy

Mole Eliminator® Trap

Eliminate moles on the first try

Durable electroplated steel stands up to years of use. Place scissor-like trap over active “travel” tunnels, which tend to be long and straight. Set by pressing down the activator with your foot. 6”L x 6”W x 12”H.

Item #
RMEL

Price
\$32.99



RAMPAGE® Fastest-Acting Baits

Control rats and mice with just one dose of this bromethalin bait, even anticoagulant-resistant rodents. Highly palatable formula ensures success. Choose Bait Chunx® for use in bait stations, or toss Place Pacs in tight areas.

Note: not for sale in (AL;WA).

Item #	Description	Price
211693	121 Place Pacs	\$109.99
211695	9-lb Pail Bait Chunx	\$159.99
211684	4-lb Pail Bait Chunx	\$89.99



JAGUAR® Bait Chunx® and Place Pacs

Get the strongest anticoagulant available for the toughest rat and mouse problems. Bait can kill in a single feeding. Bait Chunx are an all-weather rat poison that have multiple gnawing edges and a hole in the center for placing on bait station (sold separately) securing rods. Pre-measured Place Pacs provide a convenient placement option. For indoor and outdoor use.

NOTE: Cannot be sold or shipped to Alaska, California, Washington, U.S. territories or international.

Note: not for sale in (AL;AR;WA).

Item #	Description	Price
198273	73 Place Pacs	\$55.99
G79892	9-lb Bait Chunx	\$59.99
145572	18-lb Bait Chunx	\$99.99



HAWK® Bait Chunx® and Place Pacs

Kill mice and rats - including warfarin-resistant "super rats" - in as little as one feeding

Fast, effective control of mice and rats, including warfarin-resistant "super rats." Pre-measured pelleted Place Pacs are easy to place and fit in tight areas where rodents live and travel. Bait Chunx are all-weather, so they can be used to control rats and mice indoors and out. Each 1-oz. block is made with low wax and a tasty formula that works well in all types of conditions, including damp locations. Can fit in bait stations, down burrows or in other small openings where rodents live and travel. For indoor and outdoor use.

NOTE: Not for sale in Alaska, California or Washington state.

Note: not for sale in (AR).

Item #	Description	Price
198272	9-lb Pail Place Pacs	\$49.99
79930	9-lb Pail Bait Chunx	\$54.99
224077	18-lb Pail Bait Chunx	\$95.99

Use a bait rotation schedule for maximum rodent control

The purpose of bait rotation is to gradually knock down the rodent population to a manageable level. The first step is to create a rodent-free environment by rotating between anticoagulant and non-anticoagulant baits. Bait rotation helps prevent anticoagulant resistance from occurring and will keep rodent populations under control.



Kness Live Trap for Mice

Catch up to 30 mice after one setting with this foolproof mouse trap. Wind the knob until it stops and the trap is set. No poisons or baits are needed. When mice enter the trap, they trigger a paddle wheel that whisks them into the holding chamber until removal. Safe to use around children and pets. 5.5"H x 9"W x 7.25"D.

Item #	Price
127675	\$21.99



Tomcat Bait Stations

Safely houses poison to control rats and mice

Keep rodent bait out of reach from children and pets while providing a perfect hidden area for rodents to be comfortable.

Rodent Bait Station G73345 is a heavy duty station for years of use. 10-1/2"L x 10-1/2"W x 6"H.

Low-profile Bait Station 109668 is ideal for placing under pallets and desks. 13-1/2"L x 9"W x 3-3/8"H.

Economy Rodent Station 145574 is lighter weight that fits rat and mouse snap traps inside. 9-1/2"L x 8-1/2"W x 4-1/2"H.

Lockable Bait Station 217722 uses a key operation and meets EPA standards for security. This is for professional use.

Corner Mouse Bait Station G97904 is designed to fit in corners and along walls.



Tomcat Rat and Mouse Bait

Tomcat® bait is irresistible to rodents and works well as a maintenance bait after you've knocked out a major infestation and want to keep any subsequent rodents under control. All-weather bait for use indoors and out. Bait Chunx can be placed in bait stations above.

Item #	Description	Price
198274	1-lb Block, Pk of 4	\$16.99
G79700	4-lb Pail Bait Chunx	\$21.49
227665	22 Place Pacs	\$23.99
227664	10-lb Pellets	\$27.99
G79701	9-lb Pail Bait Chunx	\$39.99

Item #	Description	Price
217722	Lockable Rodent Bait Station	\$13.29
145574	Economy Rodent Station	\$15.49
G73345	Rodent Bait Station	\$17.99
109668	Low-Profile Station	\$20.99
G79704	Corner Mouse Bait Station	\$4.99



KNESS Snap-E Trap

Deluxe traps resist staining and odors and include a special handle for easier and safer setting. Strike bar travels only half of the distance of conventional traps for a quicker reaction time. Trips with entry from any direction, unlike wooden traps.

Item #	Description	Price
RSNE1	Mouse Trap	\$3.49
RSNE2	Rat Trap	\$5.49



Grandpa Gus's Old Time Natural Repellents

Each repellent contains natural ingredients based on tried and true methods.

Item #	Repels	Price
230919	Mosquitoes	\$5.99
230920	Ticks	\$5.99
230921	Spiders and Ants	\$9.99
230922	Mice	\$9.99
230918	Squirrels and Chipmunks	\$9.99



CATCHMASTER Bulk Rodent Trap Glue, 1 gal.

Contains no toxicants or poisons, making it ideally suited for areas where pesticides are prohibited or undesirable. Glue remains effective from 45°F to 120°F. Remove with vegetable oil, baby oil or paint thinner. One gallon.

Item #	Price
147703	\$45.99



CATCHMASTER Cold Temperature Mouse Glue Tray, Pkg. of 2

Glue boards solve your pesky rodent problem in cold conditions. 100% effective down to 30 degrees F. May be used in federally inspected meat and poultry establishments. 10-3/8"L x 5"W. Pack of 2.

Item #	Price
72595	\$5.49



CATCHMASTER Heavy Duty Rat, Mouse & Snake Glue Traps, Pkg of 2

Includes fasteners that prevent escape caused by dragging or tipping over the trap. Each pack contains two ready-to-use, pre-baited and pre-stickied traps and fasteners. Trap measures 5"W x 10-3/8"L. Pack of 2.

Item #	Price
72590	\$5.59



Snake Tongs

Get maximum holding pressure with minimal risk of damage to the reptile being handled with these broad-jawed snake tongs. Aluminum tubing makes this unit lightweight yet strong. Made from aircraft-quality metals. 40"L.

Item #	Price
73161	\$101.99



Dr. T's® Snake-A-Way Snake Repellent, 1.75-lb. Bottle

Keep unwanted rattlesnakes and garter snakes out of your barn, shed or yard with this EPA-registered granule deterrent.

Sprinkle a 5–6" perimeter around the area you want to keep snakes out of. If a snake approaches, its sensory perception is altered and the snake turns away, leaving the area.

NOTE: Not available for sale in Alaska, California, Hawaii, U.S. Territories or International.

Note: not for sale in (AL;AR;GA).

Item #	Description	Price
G77365	28-lb Pail	\$104.99
G77363	1.75-lb Bottle	\$12.99
G77364	4-lb Bottle	\$17.99



Shin Armor Gaiters

Heavy-duty, 1,000-denier, water-resistant nylon guards with impact-resistant inserts. Cover legs just below the knees to the ankle and metatarsal area so they do not affect movement. 1"W straps with buckles adjust for a better fit. Flame retardant. Weigh 11 oz. Sold as a pair. Specify size: L (fits 14–18" calf) or XL (fits 18–23" calf).

Item #	Price
G11060	\$78.99



Heavy-Duty, Waterproof Snake Chapz™

Heavy-duty 1,000-denier nylon with a patented insert system provides snake-proof protection up to a minimum of 18" from the ground. Cool and comfortable and easily attach to belt with adjustable clips and strapping. 15"L YKK zipper on inside of leg facilitates boots. Waterproof. Weigh 2.1 lb. Sold as a pair. Specify snake-proof height: short (18"L), regular (19"L) or tall (20"L). Tall (20"L) in 26" thigh only.

Item #	Fits	Price
G11052	26" Thigh	\$98.99
G11053	29.5" Thigh	\$98.99



CATCHMASTER Gold Stick Fly Trap

This gold stick fly glue trap comes with a powerful pheromone to increase the amount of flies collected. It comes packaged in a perforated box for ease of handling. Either place the 24"L fly stick on a windowsill or hang vertically in areas away from traffic. Perfect for use in stables, barns, garages or warehouses. Apply with the included pheromone tube.

Item #	Price
127641	\$5.99



Biting Fly Trap

Simply place a trap every 70–100' around the perimeter you want to protect. Flies are attracted to the fiberglass panel when sunlight shines through, leaving them trapped on the replaceable sticky sleeve. Each trap collects up to 5,000 flies before the sleeve needs to be replaced. Requires no poisons, baits or electricity. Each trap contains one fiberglass cylinder, two sleeves, one 24"H wooden stake, two large paper clips and two brass-plated paper fasteners.

Item #	Description	Price
217730	Biting Fly Trap	\$17.49
217796	Repl. Sticky Sleeve, Pk 10	\$19.99



CATCHMASTER 24'L Double-Sided Fly Sticky Trap

Flies are attracted to the fluorescent color of this double-sided sticky trap. A sex attractant and food bait are added to the glue to make it irresistible to flies, making the trap even more effective. Hang this trap in your barn or stable. When it's covered with flies, pull a clean section out like you would a window shade while rolling up the old catches. 24'L x 11"W.

Item #	Price
RC430	\$16.99



Electric Black Light Fly Trap, 17"L x 8"H

This Electric Black Light Fly Trap meets FDA and USDA standards for use in food preparation areas

This 17"L x 8"H Electric Black Light Fly Trap is economical and easy to maintain. Houseflies and other nuisance flying insects are highly attracted to its black light energy. Trap includes double light and one glue board. Replacement glue boards sold separately (Item No.), sold 25 per box.

Replacement bulbs are available. If your Black Light Fly Trap was purchased before July 2012 or after June 2016, order Item No. 145869. If your Black Light Fly Trap was purchased between July 2012-May 2016, order Item No. 214375.

Item #	Price
127499	\$171.99

DYNATRAP Insect Traps

No propane or attractant refills needed. Utilize a simple three-step system: 1) A UV fluorescent bulb produces warm light to attract bugs. 2) The titanium dioxide-coated internal surface emits odorless mosquito-attracting carbon dioxide. 3) A powerful, whisper-quiet and vacuum fan traps pests inside a retaining cage. All units include cleaning brush and power cord. Runs on 115V AC. 198322 is for indoor use only. Replacement bulbs available online.

Item #	Coverage	Price
198322	1,250 sq ft	\$129.99
198324	1/2 Acre	\$129.99
211628	1 Acre	\$199.99



QuickBayt Fly Bait

QuickBayt™ is the standard for the control of houseflies in ag production and commercial facilities. Includes two powerful fly attractants and a bitter agent to help prevent accidental ingestion. Begins killing flies in 60 seconds and remains effective up to four weeks. Twice as fast as competitive products and eliminates resistance problems. Spot spray is mixed with water and sprayed or painted on surfaces where flies gather (will not stain). 1 lb. mixed with 1 gal. of water will treat 1,000 sq. ft. NOTE: This product will kill any insect, including bees. Do not use inside food processing plants, restaurants or in areas accessible to food producing animals. Item # 151343 is not registered for sale in NY, VT or WA. EPA registration No. 11556-137 for granules and No. 432-1455-11556 for spot spray.

Item #	Description	Price
214364	35-lb Granules	\$269.99
147985	5-lb Granules	\$49.99
151343	1-lb Liquid	\$64.99

FLOWTRON Indoor/Outdoor Electric Insect Control

Three powerful black light bulbs attract flies and remains collect in removable tray. Covers 2,000 sq. ft. indoors and up to two acres outdoors. Optional octenol increases effectiveness during day. Meets OSHA and USDA requirements.

Item #	Description	Price
151303	Fly Zapper	\$329.99
151305	Repl. Black Light Bulb	\$35.99
151304	Octenol Lures, Pk 6	\$56.79



FLOWTRON Outdoor Insect Killers

Insects are attracted to the UV light, fly into an electric grid and are instantly killed before falling to the ground. Includes one octenol lure.

Item #	Description	Price
166903	Repl Bulb for 1-1/2 Acre	\$18.49
166905	Repl Bulb for 1 Acre	\$18.49
166897	1-Acre Killer	\$64.99
160367	1-1/2 Acre Killer	\$79.99





8-oz. Mosquito Bits®

Eliminate mosquito larvae with the same tools used by the pros. Mosquito Bits® and Dunks® kill the immature, aquatic stage of the mosquito. BTI (Bacillus thuringiensis israelensis) is lethal to mosquito larvae, but harmless to fish, humans and other animals. Sprinkle or toss into standing water in breeding grounds to eliminate mosquito larvae. One dunk or 4 oz. of bits treat up to 100 sq. ft. of water surface.

Note: not for sale in (AE;AP;AA).

Item #	Description	Price
G77200	8-oz Bits	\$11.99
G77202	20-lb Bits	\$115.99



Mosquito Barrier® Insect Spray

Kills mosquitoes and repels ticks and fleas within the treated area immediately upon spraying and keeps them out for up to 4 weeks. Odor disappears in about 30 minutes. Dilute the strong liquid garlic in water and spray on grass, shrubs, flowers and trees. It kills adult mosquitoes on contact and the garlic coating keeps mosquitoes out of the area. Suffocates mosquito larvae in standing water. 1-gal. container treats 5 acres.

NOTE: Cannot be sold or shipped to Idaho, Kansas, Wyoming, U.S. Territories or International.

Note: not for sale in (HI;IA;WY;AE;AA).

Item #	Price
G77380	\$95.99



Yellow Card Sticky Traps

Place traps in perimeter rows. Use 1 to 3 traps per 1,000 sq. ft. indoors. Outdoors, use at least 6 traps per field and replace traps weekly.

NOTE: Insect traps and lures provide an early warning system to detect adult insect emergence. They are not intended to reduce the insect population.

Item #	Description	Price
RSTRIP	Pk of 25, 3" x 5"	\$10.00
R16201	Pk of 50, 6" x 12"	\$87.99



TRECE Pherocon® Unbaited AM Yellow Sticky Traps

Unbaited Pherocon® AM traps measure 9"W x 11"L unfolded with a 7"W x 9"L sticky grid. Replace every 2–3 weeks. Pkg. of 25.

NOTE: Insect traps and lures provide an early warning system to detect adult insect emergence. They are not intended to reduce the insect population.

Item #	Price
T3306	\$49.99



Sticky Tape

This is a perfect solution when you cannot spray. Tape is sticky on both sides and easy to unroll. All rolls are 530'L.

Item #	Description	Price
217729	6" Wide	\$169.99
217729	10" Wide	\$275.99
217729	2" Wide	\$63.99

Ben's Tick & Insect Repellent repels even the nastiest bugs.
 With this bug spray, biting insects won't even know you're there.



Long-Lasting

The Ben's 30 water-based formula stays on your skin & lasts longer.



Fragrance-Free

Smell the great outdoors, not your repellent.



Maximum Protection

Ben's 100 is the most potent DEET formula available, for powerful insect protection.

DEET disrupts a mosquito's ability to detect carbon dioxide and other products of human metabolism, which is how they find us.



Ben's 30 Eco Spray

Ben's 30 Eco Spray evaporates slowly to repel black flies, mosquitoes and other stinging or biting insects for up to 8 hr. Repellent is so safe you can apply it to your clothing and skin. Comes in a 6-oz. aerosol spray can that contains 30% DEET.

Note: not for sale in (AL;GA).

Item #	HM	Price
109490	▲	\$7.99

▲ Requires special handling due to DOT regulations. Additional shipping charges will apply. Cannot be shipped by air.



Ben's 30 Insect Repellent Pump Spray

Convenient pump spray repellent provides protection against ticks and insects that may carry West Nile virus, Lyme disease, Eastern equine encephalitis and other infectious diseases. Evaporates slowly so it stays on longer. Easy application. 3.4 oz. size meets TSA guidelines for air travel. Note: not for sale in (AL;GA).

Item #	HM	Price
225502	▲	\$5.99

▲ Requires special handling due to DOT regulations. Additional shipping charges will apply. Cannot be shipped by air.



Ben's 100 Tick and Insect Repellent

Ben's 100 Tick and Insect Repellent is one of the strongest insect repellents available, yet safe enough to apply on skin as well as clothing. One application protects up to 10 hr. Easy-to-use 1.25 oz. pump spray bottle and contains 98% DEET.

Item #	Price
30955	\$5.99



TRECE Pheromone Lures

Pheromones are applied to a rubber septa for even release over a three- to four-week duration. Recommended traps are listed in parentheses.

NOTE: Insect traps and lures provide an early warning system to detect adult insect emergence. They are not intended to reduce the insect population.

Item #	Description	Price
T3110	European Corn Borer:IA (H)	\$2.85
T3138	Corn Earworm (H)	\$2.89
T3102	Oriental Fruit Moth (1C)	\$2.99
T3210	Beet Armyworm (B)	\$2.99
T3236	Pecan Nut Casebearer (1CP)	\$2.99
T3136	European Corn Borer:NY (1C)	\$2.99
T3141	Black Cutworm (B)	\$2.99
T3143	Fall Armyworm (B)	\$2.99



Scentry Pheromone Lures

Pheromones are applied to rubber septas, plastic chips or plastic vials for even release over a 3–4-week duration. Recommended traps listed in parentheses.

NOTE: Insect traps and lures provide an early warning system to detect adult insect emergence. They are not intended to reduce the insect population.

Item #	Description	Price
EL215	Corn Earworm (H)	\$3.49
EL104	Codling Moth (1C)	\$3.49
EL804	European Corn Borer: NY (1C)	\$3.49
EL103	Clearwing Borer (1C)	\$3.49
EL803	European Corn Borer: IA (1C)	\$3.49



NoMate® Codling Moth and Oriental Fruit Month Mating Distruptants

NoMate® spirals help reduce damage to pome fruit and walnuts by disrupting mating communication without girdling or insecticides. It releases a large amount of pheromone, which confuses the males and keeps them from mating. Apply 2–4 days after catching the first male moth in a wing trap. Just wrap around the tree stem or branch in the upper 1/3 of the canopy (at least 1–2' within the radius of the canopy). Codling moth spirals should be applied at a rate of 300–400 per acre. Oriental fruit moth spirals should be applied at a rate of 110–140 per acre. Codling moth spirals provide up to 140 days of mating disruption and oriental fruit moth spirals up to 110 days.

Note: not for sale in (0;AL;AZ;CA;CO;CT;DE;DC;FL;GA;HI;ID;IL;IN;IA;KS;KY;LA;ME;MT;NV;NH;NJ;NM;NY;ND;OH;OK;OR;MD;MA;MI;MN;RI;SC;SD;TN;TX;UT;VT;VA;WV;WI;WY).

Item #	Description	Price
145837	Codling Moth, Pk of 400	\$122.99
145838	Oriental Fruit Moth, Pk of 550	\$225.99



Disposable Red Sphere Traps

Use red sphere traps for monitoring orchards for monitoring maggot flies. One trap per 3–4 acres (five minimum per block) provides reliable detection. Place traps before petal-fall for both apple and cherry trees. Sphere Traps last one season or until completely covered with insects. Spheres only. Reusable Wire Trap Hangers sold separately. Both sold in a case of 100. Trap Kit includes 25 disposable traps, 25 wire hangers and two 8-oz. cans of sticky coating with built-in applicator brushes.

NOTE: Insect traps and lures provide an early warning system to detect adult insect emergence. They are not intended to reduce the insect population.

Item #	Description	Price
R16300	Trap Kit	\$33.99
217732	Sphere Traps	\$82.99
R16102	Wire Trap Hangers	\$92.99



TRECE 1C Wing Trap with Reusable Plastic Top

Open design with spacers separating top and bottom to trap bigger moths and insects. Versatile design for vegetable, fruit and nut crops. Select from paper or plastic top traps. Lures not included.
NOTE: Insect traps and lures provide an early warning system to detect adult insect emergence. They are not intended to reduce the insect population.

Item #	Description	Price
T3322	Repl. Bottom Liner	\$1.99
T3302	Trap with Reusable Plastic Top	\$3.99
T3300	Trap with Disposable Paper Top	\$6.59



TRECE Codling Moth Traps

Tre ce pheromone lures are applied to septas for even release over a 3 to 4 week duration for better capture rates. Position traps before bloom and monitor through harvest. Kit includes one 1CP trap, three pheromone lures and three trap liners. NOTE: CML2 lures last 12 weeks versus four weeks for the standard CM lure.

Item #	Description	Price
T3323	1CP Repl. Liner	\$2.49
T3111	Standard CM Repl. Lure	\$2.99
R01205	Codling Moth Kit	\$20.49
R012L2	CML2 Kit	\$31.49



Reusable White/ Yellow/Green Bucket Trap, 4 Pieces

Green trap is for fall armyworms and yellow/white/green trap is for black cutworms. 8.5"H x 6.5"D. Lures not included.

NOTE: Insect traps and lures provide an early warning system to detect adult insect emergence. They are not intended to reduce the insect population.

Item #	Description	Price
R03401	Yellow/White	\$25.99
R03101	Green	\$25.99



CATCHMASTER Food and Pantry Moth Trap Kit

Eliminate Indian meal moths, flour moths and other food-infesting moths quickly and easily with these nontoxic, disposable glue traps. Traps will lure moths up to 12' from infested food. Simply discard the trap when full and replace. Each pack contains two traps and two pheromone attractant lures. 8.5"L x 5"W (flat).

NOTE: Insect traps and lures provide an early warning system to detect adult insect emergence. They are not intended to reduce the insect population.

Item #	Price
151387	\$4.99



SENTRY Replacement Top For Heliothis Trap

White plastic mesh trap is reusable for three to four seasons. Removable top chamber for easy insect counting. Use to monitor European corn borer, corn earworm, cotton bollworm, tobacco budworm and black cutworm. Lures not included. 31"H.

NOTE: Insect traps and lures provide an early warning system to detect adult insect emergence. They are not intended to reduce the insect population.

Item #	Description	Price
R08300	Repl. Top	\$39.99
R08301	Complete Trap	\$98.99



PERSONALIZE

GEMPLER'S 15"-dia. Heavy-Duty Sweep Net

Our best-selling sailcloth sweep net is ideal for cotton and alfalfa

Keep track of your insect populations with our best-selling sweep net. Durable sweep net helps you collect insects year after year. The 15"-dia. sailcloth net over an extra-heavy galvanized rim with a thick 35.5"L hardwood handle stands up to almost any vegetation. Hoop is detachable from the handle for easy transport and storage.

Item #	Price
R13101	\$77.99



D-Cell Powered Aspirator

Safe, easy and fast collection of biting and resting mosquitoes. Vacuum pulls mosquitoes into a detachable tube—no more risky aspirating by mouth! Inlet tube is 6"L x 1/2" dia. Collecting tube (2" x 1") is screened on one end; cap provided. Weighs 7 oz. without batteries. (2) D-cell batteries (not included)

Item #	Description	Price
RHM200	D-Cell Aspirator	\$157.99
RHM201	Additional Collecting Tube	\$17.99



Aluminum Sweep Nets

Choose lighter muslin or tougher sailcloth. Handle and hoop are made from seamless aircraft alloy aluminum. Hoop is easily detachable, yet it will not work loose or bend back. Handles are 36"L with a foam grip. Replacement nets available online.

Item #	Description	Price
RJR100	15" Sailcloth	\$107.99
RJR015	Repl. Hoop	\$29.99
RJR001	Repl. Handle	\$64.49
RJR85	15" Muslin	\$99.99



Low-Cost Sweep Nets

Choose size and net material. All feature 36" Birch handle, except R20301 which has 36" aluminum handle. Meet USDA specs. Replacement nets available online.

Item #	Description	FO	Price
R20400	12" Sailcloth		\$36.99
R20500	12" Sailcloth		\$41.99
R20601	15" Muslin		\$41.99
R20701	15" Muslin		\$45.99
R20301	15" Muslin	■	\$61.99

■ Oversize item: additional shipping charges will apply.

Shop Supplies

You want a shop that's neat, clean and organized, with all the right tools for the job. We'll help you get there with the best brands of the tools you're familiar with, plus innovative work-savers.



NEW

DEWALT 60V MAX* FLEXVOLT® 2.5 Gallon Cordless Air Compressor Kit
230648 on pg. 15



NEW

DEWALT ToughSystem® DS300 Large Case
DWST08203 on pg. 15



NEW

DEWALT 12V/20V MAX* Jobsite Bluetooth® Speaker
DCR010 on pg. 15



NEW

Generac® 3100 PSI E-Start Pressure Washer
7143 on pg. 322

GEMPLER'S®

DEWALT®

GENERAC®

TOP BRANDS

CRESCENT
BRAND

HARPER
TOOL BRAND

LEATHERMAN

JUSTRITE

LIFETIME

Brooms, Mops & Brushes.....	309-318
Clean Up Supplies.....	319-321
Facility Supplies.....	322-333
Storage & Material Handling	334-337
Fuel Storage & Lubrication	338-348
Tire Repair & Supplies.....	349-359

Rust Control.....	360-363
Vehicle & Tractor Accessories	364-372
Tarps, Ropes & Tie Downs	373-382
Fencing Tools & Supplies.....	383-386
Hand Tools & Supplies	387-391

NEW

Vikan Round Hand Brush- Stiff

This hand scrub brush features a raised grip, so you can exert more pressure, getting a better clean. It is also great for cleaning inside machines with small entry points. 3.75"W x 5.1"H.

Item ships directly from the manufacturer in



NEW

Vikan High-Low Brush- Medium

The angled shape of this scrubbing broom is ideal where the wall meets the floor. Bristles are gentle enough to be used on equipment.

10.4"x5.5"x3.9".

Item ships directly from the manufacturer in approximately 7



NEW

Vikan Stainless Steel Floor Scraper

Stainless steel blade removes stubborn dirt and other substances. 10.25"Lx1.25"Wx6.9"H.

Item ships directly from the manufacturer in approximately 7 business days.

Item #	Price
193269	\$28.99



NEW

Vikan 59" Ultra Hygiene Handle

Optimized to be comfortable during use. Made from food grade, chemically resistant polypropylene. Easy to clean and maintain.

Item ships directly from the manufacturer in approximately 7 business days.

Item #	FO	Price
193259	■	\$26.99

■ Oversize item: additional shipping charges will apply.

- White
- Yellow



NEW

Vikan Detail Brush- Extra Stiff

Small compact hand brush suitable for cleaning in and around gaskets, rubber strips and joints on machinery. 7.9"L x 0.5"W x 0.9"H.

Item ships directly from the manufacturer in approximately 7 business days.



NEW

Vikan Short Handle Scrubbing Brush- Stiff

The stiff bristles are great for washing all types of equipment, tables and walls. 9.8"L x 2.6"W x 2.6"H.

Item ships directly from the manufacturer in



NEW

Vikan 24" Foam Blade Squeegee

Excellent on all types of floors, as the soft rubber reaches into and cleans all spaces on the floor, such as grouting between tiles.

Item ships directly from the manufacturer in approximately 7



NEW

Vikan 59" Aluminum Handle

Professional handle with an insulated sleeve for a comfortable grip.

Item ships directly from the manufacturer in approximately 7 business days.

Item #	FO	Price
193260	■	\$23.99

■ Oversize item: additional shipping charges will apply.

- White
- Yellow



**NEW****One-Piece Shovel**

Molded from FDA-compliant polypropylene, it is a workhorse for moving bulk materials. (Available in Pink, Green, Blue, Red, White, Orange, Purple, Black, Brown, Lime, and Gray.)

Item ships directly from the manufacturer in approximately 7 business days.

Item #	Blade Width	Length	Price
193250	10"	37.5"	\$56.49
193251	14"	42.5"	\$56.79

**NEW****Vikan 12" Angle Broom- Extra Stiff**

11.8"L x 1.4"W x 10.6"H. Polypropylene block with polyester Bristles.

Item ships directly from the manufacturer in approximately 7 business days.

Item #	Price
193262	\$26.49

- Yellow
- White

**NEW****Vikan 12" Deck/Wall Scrub- Stiff**

11.8"L x 2.8"W x 4.5"H. Polypropylene block with polyester bristles.

Item ships directly from the manufacturer in approximately 7 business days.

Item #	Price
193263	\$36.49

- White
- Yellow

**NEW****Vikan 24" Combo Push Broom- Soft/Stiff**

No hard edges that could trap food residue or bacteria. 7" by 14" bin, 37".

Item ships directly from the manufacturer in approximately 7 business days.

Item #	Price
193261	\$44.99

- Yellow
- White

**NEW****Lobby Dustpan w/Broom**

The dustpan has no hard edges or witness lines that could trap food residue or bacteria and can be easily disassembled and reassembled for regular washing and sanitizing. The large, 7" by 14" bin allows for big and small cleanup jobs while the tall, 37" handle alleviates back pain that stems from leaning over shorter dustpans.

Item ships directly from the manufacturer in approximately 7 business days.

Item #	Price
193256	\$81.99

- White
- Yellow



NEW

10-Gallon Bronco Round "Ice Melt" Trash Can, Pack of 6

Durable plastic walls that withstand daily use in both commercial and residential environments. NSF 2 certified for organizing and storing large quantities of food. Comfort Curve™ and helper handles aid in comfortable lifting, handling and secure tipping. Lids Sold Separately. More Colors available online.

Item ships directly from the manufacturer in approximately 3-4 business days.

Item #	Color	FO	Price
234100WH	White	■	\$234.00

■ Oversize item: additional shipping charges will apply.



NEW

50-Gallon Bronco Square Roll-Away Waste Container w/ Hinged Lid, Pack of 2

Square rolling container with double-reinforced stress ribs offer long lasting durability. Heavy-duty axle and oversize traction wheels make tipping and hauling heavy loads easier. Sturdy wide-hinged lid swings 270 degrees. Ridged handle design provides positive grip even when wet. Deep-pocket foot tilt facilitates maneuverability. The wheels are made from high-density polyethylene (HDPE) and the tires are made from HPVC. BPA Free

Item #	FT
234114	*

*Item ships by Truck due to size and weight.



NEW

Industrial strength Tilt Trucks

Industrial strength Tilt Trucks are perfect for transporting bulky loads. Durable rotationally molded construction with sturdy, reinforced rim for extra support.

Item ships directly from the manufacturer in approximately 3-4 business days.

Item #	Size	Description	FT	FO	Price
234118BK	1 yard	Standard Duty	*	■	\$1,075.69
234119BK	1 Yard	Heavy Duty	*	■	\$1,186.53
234121BK	1.5 Yard	Standard Duty	*	■	\$2,076.42
234117BK	5/8 Yard	Lid		■	\$303.56
234120BK	1 Yard	Lid		■	\$353.20
234122BK	1.5 Yard	Lid	*		\$454.76
234115BK	5/8 Yard	Light Duty	*		\$912.96
234116BK	5/8 Yard	Standard Duty	*		\$984.53

*Item ships by Truck due to size and weight.

■ Oversize item: additional shipping charges will apply.



NEW

Trash Can Dolly - Press Fit, Pack of 2

Round 5 swivel caster waste container dolly fits 20, 32, 44, and 55 gallon trash cans; offers safe transport of heavy loads. Simple twist-to-lock feature securely fastens dolly to container base. Non-marking 3 inch swivel casters cleanly roll over a variety of indoor and outdoor surfaces. NSF Std 2 - meets the criteria for clean-ability. BPA Free

Item #	Price
234111BK	\$164.98



NEW

35-Gallon Centurian Square Trash Can, Pack of 4

Square waste container offers ergonomic fit in unique spaces. Bag hooks keep liner in place. Ergonomic top ridge handle simplifies lifting and emptying. Self-venting design eases bag removal. Withstands temperatures from 32° to 180° Fahrenheit. 21.18" includes the handles. Without the handles it measures about 19.30". BPA Free

Item ships directly from the manufacturer in approximately 3-4 business days.

Item #	Price
234112BG	\$604.00
234112GY	\$604.00

- Beige
- Gray



NEW

Bin Top Utility Cart w/ Casters

Heavy-duty polypropylene built for durable hauling. Raised Walls keep contents on top and bottom shelves contained. Top compartments keep small items like cords and tools organized. Two shelf tiers encourage neat organization.

Item #	FO
234123	■

■ Oversize item: additional shipping charges will apply.



NEW
3M General Purpose Hand Pad 7447

Scotch-Brite™ General Purpose Hand Pad 7447 combines flexibility with effective cutting action and precise hand control to accomplish tough cleaning jobs or produce fine finishing results, use after use. Very fine grade aluminum oxide abrasives cut fast and fine, leaving a smooth, finished surface. Suitable for use on a wide variety of materials and for many different tasks. Case of 10.

Item #	Price
7000121088	\$41.99



NEW
3M Hand Pad Trial Pack 961S

Scotch-Brite™ Hand Pad Trial Pack 961S features 7 Scotch-Brite™ Pads, a Scotch-Brite™ Scrub Sponge and a 3M™ TWIST-LOK Pad Holder. This introductory pack gives you the chance to try a variety of hand pads before deciding which ones are right for you. Case of 5.

Item #	Price
7000121122	\$129.99



NEW
3M SandBlaster™ EDGE DETAILING Sanding Sponge, 9558

3M™ SandBlaster™ Edge Detailing Sanding Sponges are built for the demands of your job. Great for sanding painted surfaces. Case of 12.

Item #	Price
7000047828	\$52.99



NEW
3M Small Area Sanding Sponge

3M™ Small Area Sanding Sponge is for either dry or wet sanding. Ideal for sanding wood, paint, metal, plastic and drywall. Two sanding grades on one sponge in a combination of extra fine/ fine, fine/medium, or medium/coarse. Rinse and reuse. Case of 24.

Item #	Price
7000126140	\$52.99



NEW
3M Aluminum Oxide Sandpaper Assorted Grit

For general purpose sanding on paint, wood, and metal. Aluminum oxide mineral. 10 packs of 10.

Item #	Price
7100140804	\$21.99



NEW
3M SandBlaster™ EDGE DETAILING Sanding Sponge

Built for the demands of your job. Great for sanding painted surfaces and resists loading. Professional-grade foam keeps its shape for lasting use. Case of 12.

Item #	Price
7000047830	\$52.99



NEW
3M Scotch® Mounting Tape

Great general purpose foam mounting tape. Delivers a strong, permanent bond on contact. Holds up to 10 lbs. with 40" / (1 lb. per 4" of tape). 1/2 in x 150 in (12.7 mm x 3.81 m). Case of 24.

Item #	Price
7000052382	\$119.99



NEW
3M Temflex™ Vinyl Electrical Tape

7 mil thick, general purpose, vinyl electrical tape. 600V rated and withstands a temperature range of 32 to 176 °F (0 to 80 °C). 3/4 in x 60 ft, Black. Case of 100.

Item #	Price
7000008400	\$124.99



NEW
3M Scotch™ Extreme Fasteners

Grips & Releases. For indoor and outdoor use. Each inch of product holds up to 2 lbs. Audible snap indicates close. UV and Moisture Resistant. 1 in x 3 in (25,4 mm x 76,2 mm), Clear. 2 Sets of Strips, Case of 24.

Item #	Price
7100100028	\$59.99



NEW
3M Super Duty Duct Tape

3M™ Super Duty Duct Tape DT17 is designed to provide a maximum-strength, long-lasting solution for the ultimate applications. 1.9" x 105'. Case of 24.

Item #	Price
7100158390	\$239.99



NEW
3M Dual Lock™ Reclosable Fastener

Designed to deliver a durable, reclosable fastening solution which bonds to a variety of substrates including many plastics and low surface energy materials. 1 in x 5 yd. Case of 25.

Item #	Price
7000051882	\$499.99



NEW

3M Dynatron™ 3 Pack Spreaders

Dynatron™ 3-Pack Spreaders ensure that collision repair professionals have the right size spreader at their fingertips for spreading auto body filler. Each 4", 5" and 6" spreading tool features a flexible edge for precise spreading of body fillers, caulks, putties and glazes. And cured body filler easily pops off the spreader surface for fast, easy reuse with very little cleanup. Case of 72.

Item #	Price
7000045476	\$74.99



NEW

3M Scotch-Weld™ Concrete Repair DP600

Two-component polyurethane adhesive designed to repair cracks, spalls and breaks in concrete, masonry and stone. Case of 12.

Item #	Price
7100148740	\$189.99



NEW

3M Extreme Sealing Tape 4412G

3M™ Extreme Sealing Tape 4412G is a gray, highly conformable, single-sided, pressure sensitive acrylic adhesive tape with a high performance ionomer backing. It is an ideal solution for creating a water tight seal. It conforms over fasteners, seams, joints, holes and gaps to ensure a long-lasting seal on a variety of substrates. 2 in x 18 yd, 80 mil. Case of 6.

Item #	Price
7000047348	\$379.99



NEW

3M Venture Tape™ Aluminum Foil Tape

3M™ Venture Tape™ Aluminum Foil Tape 1520CW features a nominal 1.8 mil aluminum foil coated with pressure sensitive, cold weather acrylic adhesive. This tape combines flexible foil for irregularly-shaped applications and excellent low temperature performance. It conforms to fibrous ductboard and sheet metal ducts and works well in general-purpose heat shielding and light reflecting applications. 1.9 inches x 51 yards. Case of 12.

Item #	Price
7100043715	\$239.99



NEW

3M Super 77™ Multipurpose Spray Adhesive

Extremely versatile, fast-drying spray adhesive that bonds a wide range of lightweight materials. With no soak-in or yellowing over time. Case of 12.

Note: not for sale in (AR;CO;CT;DE;ID;IL;LA;ME;MT;NE;ND;OH;OR;MI;MO;RI;UT;VA).

Item #	Price
7010366503	\$109.99



NEW

3M Polyurethane Adhesive Sealant 560

A high-strength, single-component, moisture-curing, gap-filling polyurethane adhesive that creates high strength bonds on a wide variety of materials including plastics, metals, fiberglass and wood. Case of 12.

Item #	Price
7000121524	\$144.99



NEW
3M Scotch-Weld™ Threadlocker TL62

Vibration, corrosion and shock resistance for fasteners in assembled form. Case of 10.

Item #	Price
7100039194	\$114.99

NEW
3M 5-Way Penetrant

Multi-purpose aerosol spray designed to free unmovable parts that have become rusty or frozen, while displacing moisture. Case of 12.

Note: not for sale in (AR;CO;CT;DE;ID;IL;LA;ME;MT;NE;ND;OH;OR;MI;MO;RI;UT;VA).

Item #	Price
7000028601	\$249.99



NEW
3M Multi Purpose Spray Lubricant

Lubricating and penetrating oil. Demoisurizing coating to help protect metal surfaces from corrosion. Case of 12.

Item #	Price
7000028235	\$64.99

NEW
3M High Power Brake Cleaner

Cleans brake parts and assemblies without leaving residue. Large, ergonomic actuator delivers high powered stream to remove tough deposits. Case of 12.

Item #	Price
7100200512	\$48.99



#74 Supersweep All-Purpose Broom

Harper's best for fine or large particles

Will outperform any broom you've previously owned. Medium-stiff synthetic bristles are mildew resistant, hold their shape, have very good "flicking" action and retain stiffness in water. Bristles are trimmed to 3.25"L and are ideal for sweeping a variety of wet or dry surfaces, from smooth concrete to semi-rough blacktop. Pushes fines out of crevices and handles larger particles, like shell corn.

Item #	Size	FO	Price
6H7424	24"	■	\$41.49
6H7430	30"	■	\$44.99
6H7436	36"	■	\$53.99
6H7442	42"	■	\$62.99

■ Oversize item: additional shipping charges will apply.



#23 Fine-Sweeping Broom

Great for dust and fine dirt on smooth surfaces

Synthetic bristle ends are split into several thinner bristles by a process known as "feathering." Feathered bristles trap and pick up more dirt and dust (just like a dust mop). Bristles are trimmed to 3-1/8"L. For indoor use only on dry surfaces, like polished cement, wood, tile and linoleum floors in basements and shops. Complete broom includes head, steel brace, 60"L hardwood handle and iron connector tip.

Item #	Size	FO	Price
6H2418	18"	■	\$38.49
6H2324	24"	■	\$42.49
6H2330	30"	■	\$48.59
6H2336	36"	■	\$50.99
6H2342	42"	■	\$62.99

■ Oversize item: additional shipping charges will apply.



#57 General-Purpose Broom

Fine to medium sweeping for grain elevators, greenhouses and warehouses

Perfect for sweeping a variety of fine to medium debris. Made of a combination of soft and stiff synthetic fibers. Soft bristles are great for fine sweeping while stiff bristles move bigger materials like sand, dirt and leaves. Bristles are trimmed to 3-1/8"L. Complete broom includes head, steel brace, 60"L hardwood handle and iron connector tip.

Item #	Size	FO	Price
6H5718	18"	■	\$37.99
6H5724	24"	■	\$40.99
6H5730	30"	■	\$48.99
6H5736	36"	■	\$55.99

■ Oversize item: additional shipping charges will apply.

HARPER A broom for every job

Know what you are buying

These industrial-grade brooms are far superior to the dressed-down knockoffs showing up in stores. Harper brooms are guaranteed to outswEEP, outlast and outperform.

- 1** Steel handle brace stabilizes broom and reduces handle strain
- 2** Heavy-duty connector tip eliminates breakage common with screw-type handles
- 3** Strong hardwood back with stands tough treatment
- 4** 60"L, 1-1/8" dia. hardwood handle is made from the highest tensile strength, kiln-dried wood



#61 Shopkeeper™ General-Purpose Push Broom

Ideal for garages, body shops and implement shops

This dual-bristle design is for sweeping a variety of fine to medium debris. The fine-sweeping side's plastic bristles in the border of the head are ideal for sweeping dust and fine dirt on smooth surfaces, while the stiff brown plastic bristles at the center are great for sweeping medium debris on smooth or semi-rough surfaces. Bristles are tapered to 3/16". Complete brooms include head, steel brace, 60"L hardwood handle with stainless steel tip.

Item #	Head Width	Price	Item #	Head Width	Price
Complete Broom Kits			Replacement Broom Heads		
6H6118	18"	\$38.49	H6118	18"	\$22.59
6H6124	24"	\$43.99	H6124	24"	\$24.99
6H6130	30"	\$49.49	H6130	30"	\$37.49
6H6136	36"	\$50.99	H6136	36"	\$40.79



#94 Powerful Sweeping Broom

Superior long-wearing synthetic bristles are resistant to mildew and chemicals

Heavy-duty plastic bristles are stiff enough to easily gravel, large debris and more. Plastic bristles are tapered to 4/32" for maximum "licking" power. A good choice for use around water, chemicals, salt, oil and automotive fluids. Head features deep grooves, laminizers and greenhouses. Complete broom includes head, steel brace, 60"L handle and iron connector tip.

Item #	Head Width	Price	Item #	Head Width	Price
Complete Broom Kits			Replacement Broom Heads		
6H9418	18"	\$42.99	H9418	18"	\$25.99
6H9424	24"	\$49.49	H9424	24"	\$31.99



#96 Heavy-Duty Broom

Works great for wet leaves, street litter, grain bins and rough concrete surfaces

Made of strong, stiff plastic bristles that perform well in work environments. Plastic bristles resist bacteria growth and mold. Bristles are a vibrant orange color and are easily recognizable. Small head sizes work well in hard-to-reach corners. Bristles are tapered to 4/32". Complete broom includes 60"L handle and iron connector tip. 18"W laminizer, side and back. 18"W broom does not

Item #	Head Width	Price	Item #	Head Width	Price
Complete Broom Kits			Replacement Broom Heads		
6H9616	16"	\$33.99	H9616	16"	\$18.99
6H9618	18"	\$35.99	H9618	18"	\$19.99



Curved Rubber Shop Squeegees

Curved head shape traps and directs water toward the drain

Industrial-grade features make this a long-service, no-fail squeegee. Soft rubber blades flex to conform to floor surfaces, wiping them clean and dry with one pass. 60"L x 1-1/8"-dia. handle is high-tensile-strength, kiln-dried hardwood. Unlike cheaper styles, these squeegee heads are fastened with cast aluminum sockets and steel stabilizing braces to prevent frustrating handle breaks.

Item #	Head Width	FO	Price
6HR24C	24"	■	\$51.29
6HR30C	30"	■	\$52.49

■ Oversize item: additional shipping charges will apply.



HARPER Moss Foam Twin-Blade Squeegees

Leaves floors dry in seconds!

The unique, moss foam rubber cleans all types of smooth and semi-smooth surfaces, from cement to tile and even brick. Moss foam digs deep into uneven surfaces to remove liquids and dirt easier. Double-blade system leaves less moisture behind, which means floors dry quicker with less residue.

Item #	Head Width	FO	Price
139306	22"	■	\$34.29
139307	30"	■	\$41.99

■ Oversize item: additional shipping charges will apply.



HARPER Oversized Aluminum Dustpan

This dustpan has some unique features and is ideal for the shop with its oversized, 16"W scoop. Lip of the pan sits flat against the floor to allow you to sweep up the smallest of debris. Large, 9"L looping handle makes it easy to grip and hang. Pan is 16"W x 10"D.

Item #	Price
171173	\$14.49





Accessories and Replacement Parts

This hardwood tapered handle is made for Harper brooms drilled for a poke handle. Handle measures 60"L x 1-1/8"-dia.

Item #	FO	Price
248H	■	\$14.99
114HPT	■	\$15.99
85H	■	\$17.49
688		\$5.59
87		\$6.49
89		\$8.29

■ Oversize item; additional shipping charges will apply.



Flow-Thru Telescopic Handle

Telescopic handle extends from 6'L to 12'L for hard-to-reach cleaning jobs. Variable water control valve connects to standard garden hose. Insulated handle provides firm grip. Locking mechanism secures handle at any length. 3/4" nylar threads accept standard-threaded tools and brushes. Fits brushes shown on this page.

Item #	FO	Price
ML12	■	\$49.99

■ Oversize item; additional shipping charges will apply.



Hi/Lo Brush

Soft nylon fibers won't scratch surfaces and hold water and soap for those hard-to-reach places. Large cleaning surface for washing bigger vehicles. 10"L structural foam block with nylon bristle trim. Handle sold separately.

Item #	Price
8855	\$37.99



Delicate and Large-Surface Brush

Built for tough cleaning jobs. Soft, green nylon fibers have fluffy texture at ends for high water retention. 10"W brush with plastic block. Brush only; handle sold separately.

Item #	Price
364N	\$25.99





Steel Waste Receptacles

Won't rust, freeze or crack like plastic containers

Garbage cans have side drop handles and recessed bottoms for easy handling. Corrugated sides and wire-reinforced rim add strength. Lids included.

Item #	Diameter	Height	Capacity	Price
226933	13-3/8"	13-1/2"	6 gal.	\$16.09
226931	17-1/2"	23-1/2"	20 gal.	\$19.29
226934	16-3/10"	15-1/2"	10 gal.	\$19.29
226932	20-1/2"	27"	31 gal.	\$24.69



Big City Can Liners

Perfect for heavy loads

Blended linear low-density polyethylene easily handles sharp, heavy and irregular waste. Offer exceptional strength with good puncture and tear resistance. Black liners 1-mil thick and greater are environmentally friendly—made of 10% post-consumer waste.

Item #	Height	Width	Color	Capacity	Qty./Pkg.	Thickness	Price
225158	39"	33"	Black	33 gal.	150	1.5 mil	\$46.99
225159	63"	38"	White	55 gal.	100	1.35 mil	\$56.99
225157	58"	38"	Black	60 gal.	100	1.7 mil	\$59.99
225160	75"	52"	Black	96 gal.	50	2 mil	\$62.99
224943	63"	38"	Black	55 gal.	50	2.7 mil	\$65.99
224940	33"	23"	Black	16 gal.	500	0.7 mil	\$67.99
224942	48"	50"	Black	65 gal.	100	1.7 mil	\$82.99
224941	58"	38"	White	60 gal.	100	2 mil	\$99.99



GEMPLERS Economical Shop Wipers

A great wiper for quick cleaning of workers' hands, parts and general clean up around the job. They'll save you money when compared to the high cost of rental shop towels and rags.

Item #	Description	Price
156208	Center Pull	\$20.99
151258	Quarter Fold	\$68.99



GEMPLERS Hand Cleaner Towels

Powerful cleaning without soap and water

Keep a handy dispensing container in your truck, by tool boxes or on shop benches. Industrial-strength, waterless hand cleaner cuts through tar, grease, wax, ink, paint, lubricants and adhesives. Great for cleaning tools and equipment, too. These citrus-scented towels are fortified with an emollient and natural oils so they won't crack or dry hands. Towels are soft on one side and abrasive on the other for scrubbing. Easy-to-use dispensing container allows for convenient access and storage. Choose from a pkg. of 130, 10"W x 12"L pre-moistened towels or a pkg. of 70, 9.5"W x 12"L pre-moistened towels. Note: not for sale in (AR).

Item #	Description	Price
147979	70-Count Container	\$13.99



GEMPLERS Citra Clean Waterless Hand Cleaner

Removes tough dirt but is gentle on hands

Our liquid, industrial-strength, waterless hand cleaner available with or without volcanic grit is safe to use and gentle on hands because it contains no petroleum solvents. Odor-removing power comes from the all-natural extract of orange peels, known as d-limonene. A440 and 440G are NSF E4 certified. Note: not for sale in (AR).

Item #	Description	Price
FP	Steel Wall Rack for Gallon	\$12.49
440G	1-gal. with Grit	\$20.49
219578	1-gal. Grit-Free	\$25.99
175180	Dispenser Pump for Gallon	\$4.99
A440	1-pt. with Grit	\$7.49
219577	1-pt. Grit-Free	\$7.49



GEMPLERS Powdered Laundry Detergent

Combines optical brighteners and tough, industrial-grade stain removers to clean even the toughest grease and soil. Special water-softening ingredients ensure the best performance in hard water conditions. Contains all biodegradable surfactants and less than 6.0% phosphorus. Top-loading washers use 3/4-cup, while front-loading and high-efficiency washers use 1/2-cup per load. 50-lb. pail washes up to 400 loads. Lemon scented.

Item #	Size	FO	Price
160238	50 lb.	■	\$103.49
160237	25 lb.		\$63.49

■ Oversize item: additional shipping charges will apply.



GEMPLERS Multi-Purpose Cleanser

Combination heavy-duty cleaner and degreaser

Advanced formulation of hydrogen peroxide and d-Limonene cleans unlike any other peroxide-based cleaner. Takes care of common soils such as grease, blood, grass stains, ink, mold stains, coffee, tea, red wine, juice and soda, and pet stains. Simply spray on the stained area, agitate and wipe off. Use on glass, carpet, fabrics, furniture, upholstery, concrete, stainless steel, plastic, metal, clothing, counter tops, sinks, floors, appliances, tile, grout and walls. One-gallon jug.

NOTE: Always test in an inconspicuous area before using.

NOTE: For additional questions on mold removal, call our Technical Product Support Department at 1-800-382-8473.

Item #	Price
230179	\$15.49



Cleaner Degreaser

Safely dissolves dirt, grease and oil from asphalt, concrete, lawn mowers, engines, ovens, grills, tools, clothes and even carpets. Simply spray or wipe onto any surface and rinse clean. Nonflammable, water-based solution is biodegradable, noncorrosive and nontoxic. Contains no acids, abrasives or petroleum solvents and is highly concentrated. USDA-approved (A1, A4, A8). Dilution chart on container.

Item #	Shop Supplies: Size	Price
201307	1 gal.	\$11.99
201306	32 oz.	\$4.99
201308	5 gal.	\$63.99

NEW

GENERAC

**Don't get caught
with your power down!**

Find full product details at generac.com/gemplers



GP2200i Inverter Generator, 50 ST/CSA
Recessed, impact-resistant 1.2-gallon fuel tank.
Run time of 10.75 hours at 25% rated load (1 hour).
AC rated output running watts: 1700
AC maximum output starting watts: 2200
7117 \$479.00



IQ3500 Inverter Generator, 50 ST/CSA
Recessed, impact-resistant 2-gallon fuel tank.
Run time of 8.9 hours at 10% rated load (1 hour).
AC rated output running watts: 3000
AC maximum output starting watts: 3500
7127 \$1,449.00



GP3500iD Inverter 50 ST/CSA
Warmth of a mitt, feel of a glove
Recessed, impact-resistant 2.67-gallon fuel tank.
Run time of 8 hours at 50% rated load (1 hour).
AC rated output running watts: 3000
AC maximum output starting watts: 3500
7126 \$789.00



Handles fold for transport
Never-flat tires

XC6500 Portable, 49 ST/CSA
Recessed, impact-resistant 6.5-gallon fuel tank.
Run time of 14 hours at 50% rated load (1 hour).
AC rated output running watts: 6500
AC maximum output starting watts: 8125
6825 \$2,079.00



XC8000E Portable, 49 ST/CSA
Recessed, impact-resistant 8-gallon fuel tank.
Run time of 11 hours at 20% rated load (1 hour).
AC rated output running watts: 8000
AC maximum output starting watts: 10800
6826 \$2,679.00



XDS000E Diesel Portable, 50 ST
Diesel powered for less maintenance
Large capacity 12-gallon fuel tank.
Run time of 12.4 hours at 10% rated load (1 hour).
AC rated output running watts: 5000
AC maximum output starting watts: 5500
6864 \$3,799.00



Handles extend for easy portability
Never-flat tires

GP6500 389 PR 495T
Recessed, impact-resistant 6.9-gallon fuel tank.
Run time of 10.5 hours at 50% rated load (1 hour).
AC rated output running watts: 6500
AC maximum output starting watts: 8125
7690 \$789.00



SPEEDWASH™ 2900 PSI 2.4 GPM
Power sprayer has a maximum output pressure of 2900 psi and a maximum flow rate of 2.4 gpm. Includes cushion grip spray gun with PowerLock™ and a 30-ft. polyurethane hose.
6882 \$379.00



3100 PSI E-Start Pressure Washer
Electric Start with Lithium-ion battery
Power sprayer has a maximum output pressure of 3100 psi and a maximum flow rate of 2.5 gpm. Includes cushion grip spray gun with PowerLock™ and a 30-ft. polyurethane hose. Power Broom and Soap Blaster.
7143 \$409.00



Footbath Mat

Footbath mats hold solution to keep shoes and boots contaminant free. Place at entryways to areas that must be kept clean. The recessed mat surface is covered with thousands of pliable rubber scrapers that will dislodge soil. Rubber tips bend under your weight to submerge soles in the solution. Debris is channeled below for future disposal. Item # 139468 has taller walls that hold up to 5.5 gallons of solution.

Item #	Measurement	Capacity	FO	Price
139468	32"W x 39"L	Up to 5-1/2 gal.	■	\$124.99
TM222	24"W x 32"L	Up to 1 gal.		\$63.99

■ Oversize item: additional shipping charges will apply.



Disinfectant Mats

Place at the entrance of buildings to disinfect boots and shoes when workers or visitors enter. Tough poly mesh over foam core with a non-permeable bottom and sides. Deep enough to disinfect, shallow enough to not soak feet. It is recommended to rinse, dry and refill mat once a week.

Item #	Capacity	Measurement	Price
10480	2 gal.	34"W x 24"L	\$112.99
219730	8 gal.	36"W x 70"L	\$249.99
148104	3/4 gal.	18"W x 18"L	\$52.49



Virkon® S Viral Disinfectant

Perfect for all prevention and decontamination procedures including use in footbaths, in vehicles, on surfaces and even through aerial disinfection in the presence of animals. It is the fastest acting disinfectant available for Avian Influenza, and can be used effectively in both hot and cold climates. Can be stored for long periods of time. Simply add water for the dilution recommended for your procedure (1/4 cup of Virkon S to 16 cups of water for a gallon of solution for preventative footbaths). 10-lb. container. EPA registration #71654-6.

Item #	Price
151210	\$113.99



Extra-Tough Kneeling Pad

Perfect for the shop or field

Made for indoor or outdoor use to reduce the stress on your knees and lower back when kneeling on hard, rough surfaces. 7/8"-thick foam pad with nitrile rubber base for rugged work environments. Silicone-free foam will not absorb liquids and cleans easily with soap and water. Convenient, built-in handle makes it easy to carry.

Item #	Measurement	Price
148078	12"W x 22"L	\$25.99
227124	18"W x 30"L	\$49.99



WaterHog™ Entry Mats

Effectively trap dirt and water

Original Waterhog indoor/outdoor mats are the ideal choice for protecting carpets and floors in your home, shop or office from wear and tear. Mats feature a raised rubber "water dam" edge that can trap up to 1.5 gallons of melting snow, mud, salt and water per square yard. Rubber reinforced sub-structure prevents rug from crushing while helping remove dirt from boots. Fast drying. Maintenance free. Green friendly backing is made with 20% recycled rubber content. Specify color. NOTE: The actual finished size of the mat may be up to 3" shorter than the size listed due to the mat making process.

Item #	Color	Measurement	Pattern	FO	Price
134412	C, DB, E, G, MB, W	4'W x 6'L	Classic Diamond	■	\$141.99
WH4X6	C, E, LG	4'W x 6'L	Classic Square	■	\$142.99
134407	C	3'W x 8'L	Classic Diamond		\$164.99
WH3X10	C	3'W x 10'L	Classic Square		\$169.99
134408	C, DB	3'W x 10'L	Classic Diamond		\$169.99
134413	C	4'W x 8'L	Classic Diamond	■	\$203.99
WH6X8	C	6'W x 8'L	Classic Square	■	\$292.99
134415	C	4'W x 12'L	Classic Diamond	■	\$303.99
WH4X12	C	4'W x 12'L	Classic Square	■	\$304.99
134411	LG	3'W x 20'L	Classic Diamond	■	\$336.99
134404	B, Br, C, DB, E, G, MB, W	2'W x 3'L	Classic Diamond		\$34.99
WH2X3	Br, C, DB, E, G, LG, MB	2'W x 3'L	Classic Square		\$34.99
134404	B, Br, C, DB, E, G, LG, MB, W	2'W x 3'L	Classic Diamond		\$34.99
134417	C	4'W x 20'L	Classic Diamond	■	\$448.99
134405	B, Br, C, DB, E, G, LG, MB, W	3'W x 4'L	Classic Diamond		\$69.99
WH3X4	B, Br, C, DB, G, MB	3'W x 4'L	Classic Square		\$69.99
134406	Br, C, DB, LG, MB	3'W x 5'L	Classic Diamond		\$89.99
WH3X5	Br, C, DB, E, G, MB	3'W x 5'L	Classic Square		\$92.99

■ Oversize item: additional shipping charges will apply.

	Medium Brick		Gray		Dark Green
	Brown		Blue		Light Green
	Charcoal		Wine		Evergreen
	Dark Brown				



WaterHog™ Half-Oval Mats

The perfect choice to dress up indoor or outdoor entryways

The same tough material as the original Waterhog™ entry mats (above) and a great way to add a professional image to your entrance. Unique, ridged construction and "water dam" effectively remove and trap dirt, mud and snow so they stay in the mat and off your floors. Polypropylene fabric dries quickly, won't fade or rot, and can be easily vacuumed or hosed off. Rubber-reinforced face nubs prevent pile from crushing and add extra life to your mat. Green friendly backing is made with 20% recycled rubber content. NOTE: All mat sizes are approximate. Specify color.

Item #	Color	Measurement	FO	Price
139214	W	6'W x 3.3'L	■	\$112.99
139218	B	4'W x 5.9'L	■	\$139.99
139212	B, C, DB, G, W	3'W x 1.8'L		\$34.99
139213	Br, C, E, W	4'W x 2.3'L		\$56.99
139215	Br	3'W x 5.5'L		\$99.99

■ Oversize item: additional shipping charges will apply.

	Blue		Charcoal
	Gray		Dark Brown
	Evergreen		Brown
	Wine		



Medium-Traffic Floor Mats

Solution-dyed nylon fibers are guaranteed against color loss for 10 years indoors. Yarn is twisted and heat-set to enhance dirt and moisture collection as well as maximize the life of the mat. Cleated rubber backing minimizes movement on most carpets and improves traction on hard surfaces. Cleaning is easy by vacuum and extraction method or hose off with water and hang dry. Mats are machine launderable. Specify color.

NOTE: The actual finished size of the mat may be up to 3" shorter than the size listed due to the mat making process.

Item #	Color	Measurement	FO	Price
G58114	C	4'W x 6'L	■	\$113.99
G58113	N	3'W x 10'L		\$169.99
G58110	Br, DG, G	3'W x 2'L		\$34.99
G58111	Br, C, G	3'W x 4'L		\$62.99
G58112	Br, C, G	3'W x 5'L		\$77.99

■ Oversize item: additional shipping charges will apply.

- Gray
- Brown
- Blue
- Charcoal
- Dark Green



Hog Heaven™ Industrial-Grade Anti-Fatigue Mats

Soft nitrile/PVC cushion backing provides long-lasting comfort for your knees and back. Static-dissipative, nitrile rubber surface is textured for superior slip resistance and stands up to grease, oil and other shop chemicals. 3"W, uncushioned, nitrile border will remain flexible for the life of the mat and will not crack or curl. 5/8" thick.

Item #	Measurement	FO	Price
61459	3'W x 5'L		\$102.99
61461	4'W x 6'L	■	\$172.99
61460	3'W x 12'L	■	\$286.99
61458	2'W x 3'L		\$44.99
61458	2'W x 3'L		\$52.99

■ Oversize item: additional shipping charges will apply.



Bollard Sleeves

Make your old posts look like new

Eliminate annual maintenance while protecting your vehicles and posts from impact damage. These high-density polyethylene bollards are constructed with UV inhibitors to resist fading, rusting or cracking. Unique vertical ribs provide extra impact resistance while allowing for easy slide-on installation. May be trimmed for an exact fit. Specify color. NOTE: 4" post not available in black. 8" post available in red and yellow only.

Item #	Height	Outside Dia.	Inside Dia.	Post Dia.	FO	Price
217065	56"	5-3/4"	4-3/4"	4"	■	\$39.99
217793	56"	7-7/8"	6-7/8"	6"	■	\$43.49
217794	57"	10"	8-7/8"	8"	■	\$49.99

■ Oversize item: additional shipping charges will apply.



Round Steel Bollard Posts

Protect your facility from vehicle damage

Post features a durable, baked-on powder coat in safety yellow to provide high visibility. Each post is made of 1/4"-thick steel, mounted on 3/8"H steel plates that are pre-drilled with 3/4" holes for easy installation. The 4" post is mounted on an 8" square plate; the 6" post is mounted on a 10" square plate. Includes a black, high-density polyethylene cap that can be removed to fill post with concrete for extra strength and protection. Anchor bolts not included.

Item #	Height	Post Dia.	FO	Price
79262	36"	4-1/2"		\$127.49
79271	42"	6-5/8"	■	\$228.99

■ Oversize item: additional shipping charges will apply.



Reflective Bollard Sleeves

Reflective white stripes increase visibility and protection

Eliminate the need to repaint unsightly posts with the quick and easy installation of these reflective Bollard sleeves. Manufactured using 1/8"-thick, high-density polyethylene (HDPE) with stronger intermolecular forces, tensile strength and solvent resistance. Contains ultraviolet additives that withstand extreme temperatures and resist fading. Yellow with white reflective tape.

Item #	Inside Dia.	Outside Dia.	FO	Price
180069	4.72"	5"	■	\$34.49
180070	7"	7.34"	■	\$48.49
180075	8.8"	9.1857"	■	\$71.29

■ Oversize item: additional shipping charges will apply.



Shop Seat with Drawers

Keep your tools close at hand with this pneumatic stool. Includes a convenient tool storage tray, two small drawers and one large drawer. Padded seat adjusts from 17-1/8"H to 21-5/8"H. Four heavy-duty caster wheels offer dependable stability. 300-lb. capacity.

Item #	Price
223613	\$64.99



Extra-Coarse Anti-Skid Tape

Ideal for extreme traction in dirtier job environments where standard tape would get clogged by mud, oils and debris. Tough, durable, adhesive-backed grit surface provides long-lasting protection even when exposed to heavy traffic, water or grease. Use indoors or out. Conforms to irregular surfaces. Peel off backing and apply to any clean, dry surface. Black. Sold as a roll.



Item #	Roll Length	Roll Width	Price
219445	50'	2"	\$25.49
219446	50'	4"	\$44.99
219447	50'	6"	\$68.99



Z-Creeper

A creeper and a shop seat all in one. Heavy-duty 36"H steel frame has a 300-lb. weight capacity. Six-caster design rolls over uneven surfaces better than four-caster units.

Item #	Price
223611	\$39.99

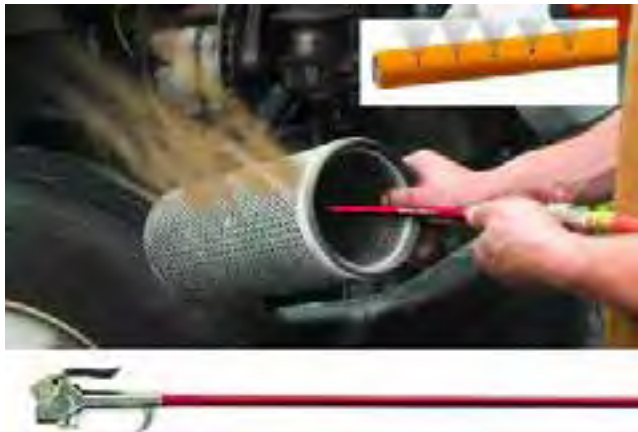

Air Comb™ Air Gun

Innovative and patent-pending air gun features a multi-port nozzle with five holes on the top of the wand that maximize air pressure and volume. Provides a focused, high-pressure output that cleans hard-to-reach areas. Fits inside oval and cylindrical air filters, radiators or AC condensers. 1/4" FNPT inlet.

Item #	Length	FO	Price
212060	12"		\$32.49
212061	24"		\$37.49
212062	36"		\$49.99
212063	48"	■	\$54.99

■ Oversize item: additional shipping charges will apply.



Hand-Crank Hose Reels

Low-profile outlet riser and open-drum slot design so hose wraps without crimping. Lubricated pillow block bearings for smooth rotation. Adjustable friction brake assembly brakes or locks the drum. Solid brass NPT swivels have nitrile seals for chemical resistance. 3,000 maximum psi. Hose not included.

Item #	Hose I.D.	FO	FT	Price
212125	1/2"			\$261.59
212126	1/2"			\$272.49
212127	1/2"	■		\$283.39
212128	3/4"			\$326.99
212230	3/4"	■		\$332.49
212231	1"		*	\$435.99



Flexzilla® Air Hose Assemblies

Made from an engineered hybrid polymer, combining the best qualities of both PVC and rubber materials for extreme flexibility. Hose has no memory, which means less kinking. Excellent abrasion resistance. Temperature range: -40° to 150°F. Working pressure: 300 psi.

Item #	Hose I.D.	Length	Male NPT	Price
165610	3/8"	25'	1/4"	\$29.99
165608	1/4"	50'	1/4"	\$34.99
165611	3/8"	50'	1/4"	\$49.99
165609	1/4"	100'	1/4"	\$69.99
165612	1/2"	50'	3/8"	\$81.49



Levelwind™ Hose Reel

Stop hassling with tangled hose!

Unique winding system automatically layers hose back and forth across the reel to ensure the hose is coiled smoothly and easily every time. Durable UV-stabilized polypropylene. Features an extra-large 3/4" swivel for maximum air flow. Swivel freely on a mounting bracket up to 138° or lock into place at up to seven different angles. Latching-mode switch lets you choose to latch the hose every 3' or switch to free run for immediate automatic rewinding. Adjustable hose stopper lets you increase or decrease the length of hose that remains when fully retracted. Carrying handle allows for portability, or reel can be mounted on the wall or ceiling.

Item #	Hose I.D.	Hose Length	Max. Hose PSI	Price
139477	3/8"	100'	350	\$214.99



3-gal. Polypropylene Measuring Pail

Pail is highly resistant to many chemicals, making it just right for mixing pesticides and other solutions. Strong steel handle and a no-drip spout makes for easy pouring. Raised graduations in quart/liter increments up to 3 gal./12L are easy to read.

Item #	Price
226090	\$41.99



Brute® 20-gal. Tote

Designed strictly for storage, this is NSF approved for handling food and features easy-access handles for convenient mobility. Easy-grip handles. Snap-tight lid keeps your contents safely secured during transport, while the reinforced rib bottom ensures years of use. Stackable bin measures 27-7/8"W x 15-1/8"H x 17-4/5"D. Specify color: Gray or White.

Item #	Price
108139	\$33.49

-  Gray
-  White



5-gal. High-Density Polyethylene Pail

Durable HDPE pail stands up to repeated use and abuse. Metal swing handle with a polyethylene grip makes it easy to carry. All colors, except for black, are FDA and USDA compliant. Equipped with an EPDM gasket for a positive seal. HDPE lid (Item # 226911) sold separately. 14-1/4"H x 11-15/16" dia. Specify color: black, green, red, white or yellow. NOTE: Black pail is not FDA compliant.

Item #	Price
226910	\$9.49

-  Black
-  Green
-  Red
-  Yellow
-  White



FILL-RITE Cast Iron Diesel Transfer Pump

Buna N seals, inlet strainer, hose barbs, hose clamps, battery clips, in-line fuse, suction tube and polypropylene nozzle. 6.5'L power cord with 3/4" inlet. 10-gpm maximum flow; 3/4" hose I.D.; 8'L PVC hose; 1/5 HP motor; 3/4" inlet size; 1" outlet size; no flow meter. Ideal for diesel transfer.

Item #	Price
163443	\$172.99



Stinger LED Rechargeable Flashlights

High-quality lighting used by professionals

Stinger LED– Delivers the optimal balance of a bright, farreaching

beam, ample peripheral light and long run times. Its brightness, power, performance, cost, and extended run time make it perfect for a variety of everyday tasks. Streamlight's most popular light.

Stinger LED HPL – High-performance model throws light a long distance. Great for illuminating the length of a dark alley, inspecting utility lines from the ground or any task that requires a far-reaching beam.

Stinger LED HL – High-lumen flashlight (640 lumens) has a wide side-to-side beam. Performing like a floodlight, this light illuminates a whole room, vehicle or any area, including the sides and corners, with a bright, revealing light.

Item #	Description	Length	Lumens	Run Time	Beam Distance	Price
219702	Stinger LED HPL	9-5/8"	740/380/190	1.25/2.5/4.5 hr.	1,437'	\$152.99
219701	Stinger LED	8-13/32"	350/175/85	2/3.75/7.25 hr.	1,017'	\$157.99
219703	Stinger LED HL	8-7/16"	640/340/170	1.25/2/4 hr.	974'	\$162.49



Rechargeable LED Worklight

Portable lighting for anywhere you need it

Get hands-free lighting that's ideal for the repair/maintenance shop, auto shop or the farm. 1-LED flashlight produces 65 lumens, 60-LED floodlight emits 120 lumens and 61-LED dual light produces 185 lumens. Run time for flashlight and floodlight is 4 hr. (2-hr. run time for dual light). Impact- and chemical-resistant housing. 11.5"L. Weighs 12 oz. Includes rechargeable NiMH battery and AC/DC charging adapter.

Item #	Price
216495	\$49.99



Waypoint® LED Rechargeable Spotlight

Features a broader, wider beam than the original WayPoint. Plus, it is water resistant to 1m and floats for easy retrieval. Impact resistance tested. C4® LED combined with a deep-dish parabolic reflector to produce a long-range beam that provides optimal peripheral illumination. Include high- and low-intensity modes and an emergency-signal mode. Cushioned pistol-grip makes light easy to grab and maneuver, and the built-in stand allows precise on-scene lighting. On/off trigger-style switch, with a secondary rotary switch that allows you to select output mode. High-impact polycarbonate housing, with rubberized lens ring. Includes lithium-ion battery with onboard safety control circuit and lanyard. Rechargeable up to 800 times. 6.75"L. Lumens 210 high/20 low. Run time (8.5 hours high/120 hours low).

Note: not for sale in (AL;GA).

Item #	Shop Supplies: Color	HM	Price
219706	Yellow	▲	\$152.99
219707	Black	▲	\$152.99

▲ Requires special handling due to DOT regulations. Additional shipping charges will apply. Cannot be shipped by air.

- Yellow
- Black



Door Bar Lock

Heavy-duty, all-steel door bar lock provides a simple solution for making sure your building is secured. This is a great way to secure office, warehouse and trailer doors from 32" to 40" wide. Made of 2" and 2-1/2" square tube steel with 3/16" walls and features a powder-coat paint finish to stand up to the toughest outdoor elements. Includes two unique barrel keys and mounting hardware. For outward-opening doors only.

Item #	Price
134192	\$179.99



Wireless Motion Detector

Monitor driveways and other unauthorized areas for people and vehicles. Weatherproof sensor features an adjustable fan beam that can be set to detect movement from 20' to 60' away. Receiver can read sensor from up to 1,000' away, features a four-zone trigger indicator light and allows you to select between four types of chime tones. Up to 12 sensors can be used with each receiver. Adjustable alarm can be set for 1-60 seconds. Low-battery indicator light lets you know when it's time to change the sensor battery. System includes receiver, sensor, 9V battery and AC adapter.

NOTE: This unit no longer needs a mounting bracket. Blue sheet with updated mounting instructions included.

Item #	Description	Price
127758	Extra Receiver	\$109.99
125804	Extra Sensor	\$144.99
125803	Single-Beam System	\$214.99



SEE-IT-ALL Convex Mirrors

Weather resistant for indoor/outdoor use

Constructed of plexiglass and backed with ABS plastic, these mirrors are lighter than traditional glass mirrors. They also provide reliable visibility in any location and are weather resistant. Each includes brackets and hardware for mounting.

Item #	Outside Dia.	Max. FOV w Area	Price
10639	26"	20'	\$109.99
10640	30"	25' ■	\$148.49
10641	36"	35' ■	\$184.99
10618	12"	12'	\$43.49

■ Oversize item: additional shipping charges will apply.



DOT-Grade 5.5'H Fiberglass Marker

Mark driveways to prevent accidents and protect equipment. Extremely durable marker springs back from accidental run-overs. Marker measures 5.5'L x 3-15/16"W. Open end of Post Driver (sold separately) allows markers to fit securely. NOTE: Customize your posts with tapes/numbers sold separately at gemplers.com.

Item #	Description	FO	Price
134474	Post Driver		\$183.99
FM60	Marker	■	\$24.69

■ Oversize item: additional shipping charges will apply.



Highly Reflective 5'H "T" Posts

Help prevent damage to your lawn and/or landscaping using these "T" posts with permanently applied reflective tape. Mark trails, driveways, parking lots, hazardous sections of road, ditches or culverts. D.O.T. retroreflective tape provides visibility up to 1/2 mile away. Made of rust-resistant PVC. Install using a rubber mallet or post driver. Specify color.

Item #	FO	Price
149739	■	\$12.49

■ Oversize item: additional shipping charges will apply.

- Lime
- Red/White
- Orange



HY-KO Reflective Fiberglass Property Markers

3M™ engineer-grade silver reflective tape strip

Low-cost, reflective sticks clearly mark property edges to help prevent damage from snowplows and warn visitors of hazards like culverts or ditch lines. Brilliant marker colors are easily visible in low-light conditions or bad weather and against many backgrounds like snow, blacktop, wooded or grassy areas. Fiberglass stick is flexible, yet very durable. 5/16" dia. Tapered bottom makes insertion easy. Pkg. of 12.

Item #	Color	Stake Length	FO	Price
G10800	Orange	4'	■	\$38.59
156297	Yellow	4'	■	\$42.99
125716	Orange	6'	■	\$66.59

■ Oversize item: additional shipping charges will apply.

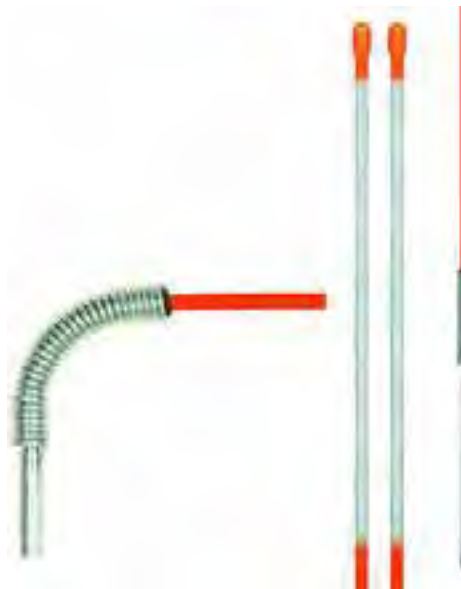

48"L Fiberglass Spring Rebound Markers

No more broken driveway markers or damaged vehicles

Highly reflective, with a flexible fiberglass rod on a rugged stainless steel spring. Spring bends flush to the ground and rebounds back into place without breaking. Rod has a reflective tape stripe. Rod measures 48"L x 1/4" dia.; spike measures 8"L x 3/8" dia. Pkg. of 4.

Item #	FO	Price
173466	■	\$28.79

■ Oversize item: additional shipping charges will apply.



Pet Station and Litter Pick-Up/Liner Bags

Encourage everyone to clean up after their dogs by making it easy and convenient. Includes bag dispenser/instructions, two rolls of 200 fully degradable DOGIPOT litter pick-up bags, an 8'L mounting post, 10-gal. steel trash bin with lid and 50 heavy-duty liners, DOGIPOT "On Leash" sign and assembly materials.

Item #	Description	FO	Price
127106	20 Rolls of 200 Pick-Up Bags		\$189.99
127108	50 Liner Trash Bags		\$22.49
127107	30 Rolls of 200 Pick-Up Bags		\$271.99
127109	Pet Station	■	\$419.99

■ Oversize item: additional shipping charges will apply.



Pedestal Grill

This heavy-duty, vandal-resistant grill has a fire box made of 3/16" steel with continuous weld construction. A formed ash lip provides extra reinforcement and helps retain coals in the box. The 300 sq. in. cooking grill has 1/2" steel bars welded on 1" centers and adjusts to four heights in the anti-theft designed slots. Grill handles have heavy-duty cool spring grips designed for public use. This grill comes with rounded corners, drain holes and 360° rotation on a 41"L x 2-3/8" outer dia. galvanized pedestal. Black enamel finish is heat and rust resistant.

Item #	FO	Price
60900	■	\$213.99





■ Oversize item: additional shipping charges will apply.



Smokers Cease-Fire® Receptacle

Safely collect unsightly cigarette butts and reduces the risk of fire. Unique "drip-lip" internal construction prevents tar condensation from escaping in high-humidity environments. FM® approved. 30"H x 11"D. One gallon capacity. Specify color: Beige, Black, Green or Gray.

Item #	Price
121719	\$57.19

-  Beige
-  Forest Green
-  Black
-  Gray



Silver Canopy Pole Tent

Made with three heat-sealed layers of waterproof polyethylene that's washable, shrink-proof, rot-proof and UV treated. Weather-resistant frame is made of galvanized steel to prevent corrosion and rust. Simple, one-person, no-tool setup and disassembly. Canopy pole tent includes frame, canopy top and ball-type fasteners.

Item #	Shop Supplies: Size	Type	FO FT	Price
G51300	10'L x 10'W	Standard Frame	■	\$166.99
G51303	10'L x 10'W	Heavy-Duty Frame	■	\$249.00
G51306	30'L x 18'W	Heavy-Duty Frame	*	\$587.99
151469	40'L x 18'W	Heavy-Duty Frame	*	\$699.99

* Item ships by Truck due to size and weight.

■ Oversize item: additional shipping charges will apply.



edral Commercial-Duty Bin Storage Cabinet

This organization system keeps parts easy to find when you need them in a hurry. Heavy-duty plastic bins suspend from steel-louvered panels in the cabinet that can be removed to take parts right to your workstation. Extra-thick yellow bins are nearly unbreakable and feature a wide stacking ledge to ensure stability when stacking. Cabinet is constructed of rugged, 16-ga. welded steel and comes complete with padlock hasp, leveling feet and 132 bins. 4"D pocket doors with extra-heavy-duty hinges open 270° to accommodate bins and/or 30-lb. capacity adjustable shelves on 2" centers. Powder-coated gray cabinet measures 72"H x 38"W x 24"D. (# of bins) and bin sizes: (48) 4-1/8"W x 5-3/8"D x 3"H, (48) 4-1/8"W x 7-3/8"D x 3"H, (18) 5-1/2"W x 10-7/8"D x 5"H, (12) 8-1/4"W x 14-3/4"D x 7"H, (6) 16-1/2"W x 14-3/4"D x 7"H. Replacement bins sold separately below.

Item #	FT	Price
24303	*	\$1,599.00

*Item ships by Truck due to size and weight.



QUANTUM STORAGE SYSTEMS Stack and Hang Bins

Heavy-duty bins are constructed from a high-density, FDA-approved polypropylene and can be used alone or stacked together. FBuilt-in rear hanger allows bins to hang from louvered panels or racks. Unaffected by weak acids and alkalis. Specify bin color: blue, green, red or yellow. NOTE: Some sizes not available in every color.

Item #	Width	Height	Depth	Capacity	Price
86216	4-1/8"	3"	5-3/8"	10 lb.	\$0.99
212056B	4-1/8"	3"	5"	8 lb.	\$1.09
212056G	4-1/8"	3"	5"	8 lb.	\$1.09
212056R	4-1/8"	3"	5"	8 lb.	\$1.09
212056Y	4-1/8"	3"	5"	8 lb.	\$1.09
86216	4-1/8"	3"	5-3/8"	10 lb.	\$1.39
86216	4-1/8"	3"	5-3/8"	10 lb.	\$1.39
86217B	4-1/8"	3"	7-3/8"	10 lb.	\$1.99
86217G	4-1/8"	3"	7-3/8"	10 lb.	\$1.99
86217R	4-1/8"	3"	7-3/8"	10 lb.	\$1.99
86217Y	4-1/8"	3"	7-3/8"	10 lb.	\$1.99
86224G	16-1/2"	5"	10-7/8"	60 lb.	\$11.49
		2"	8"		
86224B	16-1/2"	5"	10-7/8"	60 lb.	\$11.49
		2"	8"		
86225G	16-1/2"	7"	14-3/4"	75 lb.	\$12.99
		2"	4"		
86225R	16-1/2"	7"	14-3/4"	75 lb.	\$12.99
		2"	4"		
86225B	16-1/2"	7"	14-3/4"	75 lb.	\$12.99
		2"	4"		
86225Y	16-1/2"	7"	14-3/4"	75 lb.	\$12.99
		2"	4"		



Biodegradable Burlap Bags

Store feed, parts and produce

Made of 100% jute plant burlap, they're biodegradable, recyclable and contain no foreign matter. Select from a variety of sizes depending on your application. 10-oz. fabric weight. Pkg. of 25. Choose between open top, with tie or with drawstring.

Item #	Description	Width	Length	Price
139430	Burlap Bag with Drawstring	6"	10"	\$19.99
139431	Burlap Bag with Drawstring	8"	12"	\$23.49
139432	Burlap Bag with Drawstring	10"	14"	\$27.49
RB1220	Large Parts Burlap Bag	12"	20"	\$32.49
139433	Burlap Bag with Drawstring	12"	20"	\$32.99
RB1426	Large Parts Burlap Bag	14"	26"	\$33.49
RB1824	Big Parts Burlap Bag	18"	24"	\$34.99
139434	Burlap Bag with Tie	18"	30"	\$37.99
RB1830	1-Bushel Burlap Bag	18"	30"	\$37.99
RB2340	Peanut/Feed Burlap Bag	23"	40"	\$67.99
RB2236H	Dry Bean Burlap Bag	20"	36"	\$69.99



Poly Sand Bags

Woven poly with an attached plastic tie cord and hem top for quick and easy closure. The 14"W x 26"L bags (Item # G52425) hold 50 lbs. of sand and are the most common size for flood control. Can be used as weights or to hold soil samples or heavy parts. All bags have UV rating of 1,600 hours to inhibit the sun from breaking down the bag. Pkg. of 25. Specify color where optional: green (G), orange (O), tan (T), white (W) or yellow (Y).

Item #	Color	Width	Length	Price
139436	Y	10"	14"	\$12.49
139437	Y	12"	20"	\$15.99
139438	Y	14"	24"	\$22.99
G52425	G, O, T, W, Y	14"	26"	\$22.99
G52425	G, O, T, W, Y	14"	26"	\$22.99
G52425	G, O, T, W, Y	14"	26"	\$22.99
G52425	G, O, T, W, Y	14"	26"	\$22.99
G52425	G, O, T, W, Y	14"	26"	\$22.99
G51830	O, W, Y	18"	30"	\$25.49
G51830	O, W, Y	18"	30"	\$25.49
G51830	O, W, Y	18"	30"	\$25.49
139440	W	17"	27"	\$25.99
139442	W	20"	30"	\$27.99
139435	Y	8"	12"	\$9.99





Sand Bags

Each bag holds 50 lb. Close tight with attached tie string. Pkg of 25 bags. **Plain Burlap Sand Bags** – Affordable, get-the-job-done sand bags. Made from 10-oz., U.S. military-grade burlap. Biodegradable and harmless to wildlife. **Treated Burlap Sand Bags** – 10-oz. burlap is treated with an EPA-approved ammonia solution to prevent rot and mildew. Biodegradable and the ammonia solution won't harm wildlife. **Acrylic Sand Bags** – Stand up to the harshest elements. They have the longest lifespan of any textile sand bag and are designed for extreme environmental conditions. Made from a durable 10 x 10 acrylic weave. NOTE: Acrylic sand bags are not biodegradable but do allow water and air through to reduce mildew.



Woven Plastic Bags

Durable woven polypropylene bags are oil, tear and puncture resistant. Open-top bags are one of the most cost-effective forms of packaging available. White. Pkg. of 25.

Item #	Width	Length	Price
WP1830	18"	30"	\$22.99
WP18536	18-1/2"	36"	\$25.99
WP2236	22"	36"	\$29.99
WP2440	24"	40"	\$36.49
WP2640	26"	40"	\$38.49
WP2840	28"	40"	\$42.99
WP3245	32"	45"	\$56.99
WP3845	38"	45"	\$67.99
WP4054	40"	54"	\$78.99



White or Red Mesh Bags With Drawtape

Multi-purpose bags store fruits, vegetables, firewood, parts and other bulky items. Made of tough, UV-resistant plastic mesh and feature a drawtape for quick closure. White middle band can be written on using an ordinary pen or marker to identify contents or prices of goods. 24"L x 22"W. Pkg. of 25. Specify color: red or white.

Item #	Price
145506	\$29.99

- White
- Red



WESCO Drum Hand Truck/Cradle

Cradle drum for storage, dispensing and moving

The rear axle has 10"-dia. x 2.5"W mold-on rubber wheels so you can quickly load/unload drums from pallets. Non-sparking, polyolefin rollers allow easy faucet positioning of drums. Non-sparking rollers allow ease of faucet positioning. Frame clearance makes for hassle-free dispensing into 5-gal. pails. 56.5"L x 24"W x 18.5"D.

NOTE: Only for use with 55-gal. steel drums.

Item #	FO	Price
217435	■	\$307.99

■ Oversize item: additional shipping charges will apply.



Wizard Drum Lift and Drain Stand

The Wizard offers maximum versatility, allowing you to lift, move, store, drain and mix your material safely and efficiently. Durable, double-welded lift can handle up to 1,000 lbs. To operate, place bottom lift plates against drum, and fit hook over top of drum. Then place foot on lower axle and pull back on handles. Move foot to upper axle to complete the lift. Solid oak handles retract into frame for storage. Attached rollers on cradle allow drum to rotate for mixing. Measures 64"L x 22.5"H x 18.5"D. For use with 15-, 30- and 55-gal. metal drums that are at least 29"H. Ships unassembled.

NOTE: Not recommended for handling poly drums.

Item #	FO	Price
W12PKD	■	\$232.99

■ Oversize item: additional shipping charges will apply.



Closed-Head Polyethylene Drums

Meet UN specifications for hazardous liquids

Molded high-density polyethylene drums are lighter than steel, feature seamless construction and are compatible with a wide range of products. Colors are molded-in, won't dent, rust, fade or peel. All drums, except 15-gal. model, have a 2" NPS plug and one 2" buttress plug with 3/4" NPT reducer. 15-gal. drums have a 2" NPS plug and one 3/4" NPS plug and molded swing handle. FDA and USDA compliant (except black color). Specify color: BL (black), B (blue), N (natural) or W (white).

Item #	Color	Compliance	Volume	FT Capacity	Price
219464	B, N	1H1/Y1.9/100	15 gal.		\$39.99
219465	BL, B, N, W	1H1/Y1.9/150	30 gal.		\$69.99
219466	BL, B, N, W	1H1/Y1.9/150	55 gal.	*	\$75.99

*Item ships by Truck due to size and weight.

- Blue
- Black
- Natural
- White



Fuel Cans

Easy, spill-free fueling

Easy-to-use trigger and flip-down nozzle means faster fueling without the mess. Ergonomic thumb trigger lets you control the flow. Self-ventilating to eliminate the “glug,” so the flow is faster and smoother. Flexible nozzle lets you refuel without tipping the container—no more wasted fuel! No downward pressure on fuel spout required to pour. Heavy-duty, six-layer, high-density polyethylene resists permeation and improves durability. EPA, DOT and CARB-compliant.

Note: not for sale in (AR).

Item #	Capacity	Shop Supplies: Color	Price
228165	2.2 gal.	Red	\$38.97
228168	5 gal.	Blue	\$48.97
228166	5 gal.	Red	\$48.97
228167	5 gal.	Yellow	\$48.97

- Red
- Yellow
- Blue

What makes these better than all the rest?

- Rounded handle for comfort
- Metal flex hose provides slug-free pouring
- Finger-squeeze trigger lets you control liquid flow



JUSTRITE Accuflow™ Type-II Safety Cans

Improved design provides fast, smooth and controlled pouring

Constructed entirely of steel and feature a finger-squeeze trigger that keeps you in control of liquid flow and helps avoid dangerous spillovers. Built-in safety features include an internal dual-density flame arrester to dissipate heat and prevent flashback ignition; leaktight, self-closing lid; automatic venting between 3 and 5 psig to guard against pressure buildup at elevated temperatures and potential explosion; and, every can is 100% tested to guarantee leakproof construction. The flexible metal hose provides a grounding path to prevent static sparks when a grounding wire is used. Meets OSHA and NFPA standards. FM approved. UL and ULC listed. Specify color: red (gasoline), blue (kerosene), yellow (diesel) or green (oils).

Item #	Capacity	Price
139234R	5 gal.	\$101.49
139234Y	5 gal.	\$101.49
139234B	5 gal.	\$101.49
139234G	5 gal.	\$101.49
139232B	2 gal.	\$101.99
139232Y	2 gal.	\$101.99
139232G	2 gal.	\$101.99
139232R	2 gal.	\$101.99
124016G	2.5 gal.	\$94.99
124016B	2.5 gal.	\$94.99
124016R	2.5 gal.	\$94.99
124016Y	2.5 gal.	\$94.99
139230	1 gal.	\$96.99
139230	1 gal.	\$96.99
13923	1 gal.	\$96.99
139230	1 gal.	\$96.99

- Green
- Blue
- Yellow
- Red



Hinc Fuel Caddies

High-quality, commercial-grade fuel caddies constructed of heavy steel

These fuel caddies save you time and money by bringing fuel to your equipment instead of taking your equipment to a fueling station. Transport and store a wide range of fluids including gasoline, diesel fuel, kerosene, mixed fuels, industrial coolants and mid-viscosity oils. Made with 14-ga. steel that is seam welded and 100% pressure leak tested. Each caddy includes a machined cast aluminum pump capable of transferring approximately 5 gallons of fluid in 100 rotations. Includes 8'L polyurethane and PVC double-bonded hose with internal ground, brass 3/4" NPT fittings and aluminum nozzles. Feature 6"H x 2" dia. vent fill necks with zinc-plated steel caps and removable handles. UL listed rebuildable fuel gauges. 10"-dia. solid rubber tires. 15-gal. and 20-gal. models have side handles for secure storage. Specify color: blue, green or red.

Item #	Capacity	FO	FT	Price
227055	15 gal.	■		\$519.99
227054	20 gal.	■		\$539.99
227053	30 gal.		*	\$575.99

*Item ships by Truck due to size and weight.

■Oversize item: additional shipping charges will apply.

- Green
- Red
- Blue



Type-II Safety Cans

Two openings for safer, more-controlled dispensing

Galvanized steel helps reduce the danger of explosion while dispensing flammable liquids. Features two openings: a pressure-relief spring closing lid for filling and an actuated pour valve with a flexible, 12"L x 7/8"-dia. metal spout. Filler spout and flame arrestors are made of non-sparking brass to protect against flashback. Double-interlock, no-weld bottom seam. Features a patented comfort grip trigger release and spring closing lid with neoprene gasket vents at 5-psi internal pressure. FM, UL and ULC approved. Meet OSHA 29 CFR 1910.106, 1926.152 and NFPA Code 30 requirements. Specify color: red (gasoline), blue (kerosene) or yellow (diesel).

WARNING: This product can expose you to chemicals including lead, which is known to the State of California to cause cancer and birth defects or other reproductive harm. For more information go to www.P65Warnings.ca.gov

Item #	Capacity	Price
224956	2 gal.	\$82.49
224956	2 gal.	\$82.49
224956	2 gal.	\$82.49
224957R	5 gal.	\$86.99
224957B	5 gal.	\$86.99
224957Y	5 gal.	\$96.99

CARB-Compliant Fuel Cans

You can now fill even your smallest pieces of equipment without the risk of knocking them over. Spillproof spouts with thumb button controls do not push down on your tank's filler neck. Professional-grade cans stop flow automatically and the stainless steel filter screens prevent dirt and debris from entering your tank. Semi-translucent containers with molded quart and liter markings. Nozzle has a stainless-steel filter screen that prevents dirt and debris from entering your tank

Item #	Capacity	Color	Description	Price
151293	1.25 gal.	Red	Gas Can	\$21.49
151294	2.5 gal.	Red	Gas Can	\$26.99
151296	5 gal.	Blue	Kerosene Can	\$32.99
151295	5 gal.	Red	Gas Can	\$37.99
151297	5 gal.	Yellow	Diesel Can	\$38.99



Portable Fluid Transfer Containers

Make transferring fluids a simple, fast, clean and safe process

Transfer a wide variety of fluids, like fuels, lubricants, oils, chemicals, antifreeze, bio-diesel and more.

Rotationally molded with a 3" cap and metal vent.

Colors provide fluid identification. **10.5-gal. cans** are 11-3/8"W x 11"D x 31-5/8"H. **15-gal. cans** are 14-1/2"W x 14-3/4"D x 27"H.

Item #	Color	Capacity	Fuel Type	Price
228301	Red	10.5 gal.	Gasoline	\$69.99
228302	Blue	10.5 gal.	Kerosene	\$69.99
228303	White	10.5 gal.	Hazardous Fluids	\$69.99
228304	Yellow	10.5 gal.	Diesel	\$69.99
228307	White	15 gal.	Hazardous Fluids	\$94.99
228308	Yellow	15 gal.	Diesel	\$94.99
228305	Red	15 gal.	Gasoline	\$94.99
228306	Blue	15 gal.	Kerosene	\$94.99





FILL-RITE In-Line Digital Turbine Meter

This polymer meter eliminates straining to see fuel flow from a tank or pump several feet away. Attach meter wherever you need it—even at the end of the hose! Accurate within 1%. Features a sealed electronic circuitry to provide years of use in almost any condition. Factory presets for 18 fluids. Easily measure gallons, liters, quarts, pints and ounces with one meter. Rubber boot helps protect from damage. Requires (2) AA batteries (not included). Flow rate: 2-35 GPM / 8-132 LPM. Operating pressure: 50 psi. Operating temp: -40°F to 176°F. 1" NPT inlet/outlet. Hose and nozzle not included. Compatible with DEF, antifreeze, de-icing fluid, non-potable water and other chemicals.

Item #	Price
228347	\$179.99



144-oz. Chemical-Resistant Polyethylene Funnel

This heavy-duty funnel is chemical-resistant, sparkproof, rustproof, dentproof and boilproof for long life and safe operation. Includes a fine mesh, 100 grit interchangeable filter that snaps tightly into funnel mouth base to prevent debris from entering your tank. When not in use, the filter conveniently stores on the rim. Translucent funnel lets you know at a glance what the fluid level is when you pour. Specify color: black or translucent.

Item #	Price
G40090	\$9.99

- Black
- Translucent



24-oz. Chemical-Resistant Polyethylene Funnel

Heavy-duty funnel is chemical-resistant, sparkproof, rustproof, dentproof and boilproof for long life and safe operation. Translucent so you know at a glance what the fluid level is when you pour. Black, anti-splash ring helps prevent spilling. Includes a fine mesh, 100 grit interchangeable filter that snaps tightly into funnel mouth base to prevent debris from entering your tank. When not in use, the filter conveniently stores on the rim.

Item #	Price
G40150	\$7.49



Replacement 9"L HDPE Funnel

Replacement funnel for Eagle Type-I metal safety cans (Item #s 52200, 52201, 52202). Allows for easy, safe pouring. Constructed of high-density polyethylene (HDPE) for excellent durability. Yellow color.

Item #	Price
52500	\$6.99



Endurance Plus Poly Diesel Tanks

Lockable poly lid protects pump from the elements

Manufactured from specifically formulated diesel-grade polyethylene for long life. Built-in 10-gpm pump comes with a splash-resistant breather, a lockable polyethylene lid to protect the fully enclosed pump and an on/off switch at the pump so you don't have to run to the battery to shut off power. Features an easy-to-clean suction strainer and a convenient 3/4"-dia. drain bung if you ever need to drain the tank. Included is a 19'L, 3/4"-dia. hose with anti-kink spring, an auto shutoff nozzle, a swivel to prevent tangles, a 13'L cable with alligator battery clips to connect to a 12V battery and threaded brass inserts for mounting.

Item #	Length	Capacity	Height	Width	FT	FO	Price
217436	31"	25 gal.	19"	27"	*		\$796.43
217437	31"	55 gal.	29"	27"	*		\$857.00
217438	48"	55 gal.	21"	34"		■	\$898.93
217439	51"	75 gal.	31"	21"	*		\$929.68
217441	48"	100 gal.	29"	34"	*		\$957.00
217440	51"	100 gal.	38"	21"	*		\$991.18

*Item ships by Truck due to size and weight.



Poly Rotary Pump

Durable, chemical- and corrosion-resistant polypropylene. Dispenses petroleum products, water and water-based chemicals plus many acid and alkali solutions. Pumps in both directions for an output of 6 gpm per 70 revolutions. Discharge spout rotates to dispense fluid in any direction and also has a ribbed end for attaching plastic hoses. Three-piece, 47"L suction tube adjusts to fit 15- to 55-gal. drums with 2"W bung openings. Includes strainer that filters out unwanted particles. NOTE: Not for use with sulfuric acid or gasoline.

Item #	Price
RP90	\$104.99



FILL-RITE Rotary Hand Pump

Ideal for medium viscosity liquids as well as oils, gasoline and diesel fuels. Includes a built-in anti-siphoning device and corrosion-proof, adjustable suction pipe and bung adapter. Pumps in clockwise rotations. Provides up to 10 gpm per 100 revolutions. Pump may be padlocked. Fits 2"W bung openings. 3/4"-dia. outlet. Includes hose and nozzle. Optional flow meters sold separately.

Item #	Price
G54703	\$174.99



FILL-RITE 115V AC Pumps

Heavy duty and ideal for stationary installations, such as tank and barrel mounting. Can be used with gas, diesel and other petroleum-based products. Feature a durable, explosion-proof motor with ball bearings. Thermal-overload protected and 30-min. duty cycle. Includes a 2" NPT threaded base and 3/4" or 1" manual lockable nozzle. UL, C-UL listed.

Item #	Inlet Size	Outlet Size	Hos e I.D.	FT	FO	Price
225003	1-1/4"	1"	1"	*		\$1,399.00
182027	1" MNPT	3/4" FNPT	3/4"			\$385.99
108397	1-1/4" MNPT	3/4" FNPT	3/4"		■	\$534.99
219478	1-1/4" MNPT	3/4" FNPT	3/4"		■	\$695.99

*Item ships by Truck due to size and weight.
 ■Oversize item: additional shipping charges will apply.



FILL-RITE Heavy-Duty DC Pumps

Explosion-proof motor with permanent magnet, powdered iron rotor and cast bronze or acetal vanes (horsepower and materials of construction vary with model). Ceramic carbon seal reduces wear and repair expense making these pumps real workhorses. Corrosion-proof adjustable suction pipe. Pumps may be padlocked for security. 2" NPT threaded base for tank openings. UL/C-UL listed. NOTE: Horsepower and materials of construction vary with model.

Item #	Inlet Size	Max Flo w GPM	Outlet Size	HP	Hos e I.D.	Nozzle	Flow Meter	HM	FO	Price
G54700	1" MNPT	15	3/4" FNPT	1/4	3/4"	Manual	No			\$349.99
G54701	1" MNPT	20	3/4" FNPT	1/4	1"	Automatic	No	▲	■	\$749.99

▲ Requires special handling due to DOT regulations. Additional shipping charges will apply. Cannot be shipped by air.
 ■Oversize item: additional shipping charges will apply.



FILL-RITE Nozzles

Both nozzles feature handles that latch open for filling and automatic shutoff when full for hands-free fuel transfer. **3/4" Diesel Nozzle** – For use with 15-gpm transfer pumps (Item #s G54700 and 182027, sold separately). **1" Unleaded Nozzle** – Designed for use with 20-gpm transfer pump (Item # G54701, sold separately). High flow rate up to 30 gpm. Three-position latch allows automatic flow at 8, 24 or 30 gpm. 50-psi working pressure. 1" NPT inlet and 1-1/8" O.D. spout. UL/C-UL listed for gasoline, diesel and kerosene.

Item #	Description	Price
219435	1" Unleaded Nozzle	\$149.99
171554	3/4" Diesel Nozzle	\$79.99



FILL-RITE Digital Flow Meter

This digital flow meter measures a wide range of fluids, including most automotive fluids, mild acids and many industrial chemicals. Reads in ounces, pints, quarts, gallons and liters with a ±0.5% accuracy. Face can be adjusted 360° and digital LCD shows/stores current and cumulative flow totals. 2- to 20-gpm flow range. 20 stored calibration settings can be accessed quickly with simple push-button operation. Corrosion-resistant polypropylene body. Runs on (2) AA batteries (included). 1" NPT. NOTE: Do not use to meter gasoline or fluids with a flash point of 100°F or less.

Item #	Price
192038	\$229.99



FILL-RITE Optional Flow Meters

For fluid transfer pumps

Prevent overflows while keeping tabs on fuel usage with this resettable flow meter. Measure fluids at temperatures up to 150°F and pressures up to 50 psi. The master totalizer keeps track of total gallons pumped. **Flow Meter for up to 20-gpm Pumps** – Operates at 5 to 20 gpm and reads up to 99.9 gal. Master totalizer reads up to 99,999.9 gal. **Flow Meter for High-Capacity Pumps** – Operates at 6 to 40 gpm and reads up to 999.9 gal. Master totalizer reads up to 999,999.9 gal.

Item #	Description	Price
G54707	For 20 gpm Pumps	\$199.99
G54708	For High-Capacity Pumps	\$253.99



FILL-RITE Fuel- and Oil-Pump Accessories

Replace worn out or lost components or upgrade existing systems. Fuel hoses work with all electric transfer pumps to pump diesel, gasoline, kerosene and biodiesel up to B20 and E15. Nitrile inner tubing and neoprene exterior coating resist cuts, snags, abrasions and punctures. Stainless steel static ground wire ensures safe fueling. Filters are available in high-quality 10 micron particulate or water absorbing.

Item #	Description	Price
219476	Filter, 10 Micron Water Absorbing, Particulate fits 219475	\$22.49
145595	Replacement Vented 2" Cap	\$27.99
139037	3/4" I.D. x 12' Fuel Hose	\$29.99
219477	Filter, 10 Micron Particulate fits 219474	\$32.99
219510	Vented Cap with 2" Base	\$38.99
219474	Filter Head 1"	\$45.99
219511	3/4" Multiplane Swivel	\$46.99
171551	3/4" I.D. x 20' Fuel Hose	\$47.99
219475	Filter Kit, 3/4" Water Absorbing, Particulate	\$49.99
191979	1" I.D. x 14' Fuel Hose	\$49.99
171552	1" I.D. x 20' Fuel Hose	\$59.99
219512	1" Multiplane Swivel	\$69.99

LOCK LUBE Grease Couplers

Locks on for easy, mess-free, one-handed greasing

Keep the coupler on your grease gun aligned and eliminate wasted grease! Lets you put the grease exactly where you want it. Plus, save your knuckles from scrapes while trying to detach a pressure-locked coupler—simply depress the trigger to release, even under pressure. Suitable for high-pressure, heavy-duty applications. Works on all grease gun types (pneumatic, manual and electric), plus all DIN and SAE specification zerks (grease nipples). Fits 1/8" NPT thread. Standard Coupler extends your reach by 2". XL provides nearly 4" of reach to get to recessed or shielded grease fittings easier and quicker.

Item #	Description	Price
227151	Standard	\$29.95
228348	XL	\$39.95

Lincoln PowerLuber Cordless

Rechargeable Grease Guns

Meet the demands of all your lubrication and preventive maintenance jobs

Powerful motor delivers a constant grease flow with long-lasting, fully rechargeable batteries give you the mobility you need. All grease guns are balanced for easy use and feature a plated steel barrel with locking follower rod and accessible check valve and blow-off valve. The **14.4- and 18V PowerLubers** feature a built-in stroke indicator that accurately measures grease output and a smart charger that recognizes the condition of the batteries. The supercharged **20V Li-ion PowerLuber** delivers up to 10,000 psi to maximize output while reducing load on the battery and allowing more cartridges per charge. Kit comes complete with PowerLuber™, interchangeable battery (the 20V kit parts included, one and a half 1/2" fittings with four tubes) or only one tool. **NOTE: Grease not included.**



Kits come in an impact-resistant carrying case



20V LI-ION POWERLUBER

- Longest runtime
- 1770 psi output for extra output
- 1770 psi psi output
- 12 grease cartridges per charge



18V POWERLUBER

- 10.6HPV output (3000 RPM)
- High output, high pressure mode
- 10 grease cartridges per charge



14.4V POWERLUBER

- High output application
- 8 grease cartridges per charge



12V POWERLUBER

- High output application
- 7 grease cartridges per charge
- Provides 110 psi pressure

Item #	2236A1*	173156▲	134107▲	228328*
Price	\$293.99	\$259.99	\$253.99	\$249.00
Battery Type	Li-Ion Ion	NiCad	NiCad	Li-Ion Ion
Voltage	20V	18V	14.4V	12V
PSI	10,000	7,500	7,500	8,000
Motor	Two-Speed	Two-Speed	Two-Speed	One-Speed
Output	18 Grease Cartridges	10 Grease Cartridges	8 Grease Cartridges	7 Grease Cartridges
Replacement Battery Item #	2236B1*	173105▲	139033▲	228329*
Price	\$72.49	\$112.99	\$112.99	\$56.75
Replacement 110V Charger Item #	2236C4	179024	139034	
Price	\$42.99	\$57.99	\$57.99	

*Requires special warranty as a D.V. requirement. Additional charges apply for shipping and handling. Call us at 800-382-8473 for more information.

▲ PowerLuber™ Grease and Application Accessories - www.lincolnpower.com



PowerLuber™ Flex Hoses

Replacement hoses fit all line PowerLuber models

Item #	L	Price
125502	3'	\$34.99
668664	10'	\$41.99
125503	30'	\$46.49

Lincoln Fully Automatic Pneumatic Grease Gun

Made for rugged use, heavy-duty and air-powered. Combines a ceramic seal gun with a variable speed trigger for years of comfort and durability. Features an accessible check valve and a 1/2" over-rotator to eliminate grease bypass and heavy-duty springs to help in prime location. 30% high-pressure hose increases your reach and comes with a coupler and attachment clip for easy storage. 400-psi, 10-oz. Reservoir (range 40-150 psi with 1000 psi maximum pressure) 1/2"-dia. 14.5-oz. Cartridge (100 psi capacity) **NOTE: Grease not included.**

Item #	Price
151482	\$103.49



Powered by your shop's air supply



Grease/Caulk Box

Holds up to 12 cartridges

Eliminates the waste due to lost or damaged grease or caulk tubes. Tough ABS plastic. Stores 2"-dia. tubes in an upright position. 11.25"W x 11.5"H x 8"D. Includes 48"L x 1"W shoulder strap. NOTE: Grease and caulk not included.

Item #	Price
145928	\$24.49



Grease Joint Rejuvenator Cleaning Tool

Unclog stubborn grease joints!

Unique 1144 stress-proof steel tool allows clogged grease joints or fittings to take on grease by injecting light viscosity oil into the joint through the fitting, which loosens hardened grease that won't allow the new grease to flow through. Included in the kit is a flexible 4,800-psi hose extension, which may be needed to access difficult-to-reach fittings. 8.5"L. Includes flex hose extender, coupler and case. Lifetime warranty.

NOTE: This grease joint cleaner comes in a black blow-molded case.

Item #	Price
109643	\$49.99



Grease

Quality, lithium-based greases keep a variety of equipment in working order. All come in 14.1-oz. tubes.

Item #	Description	Price
198560	General Multi-Purpose	\$4.29
198556	Crimson	\$4.29
198562	Multi-Purpose GM/Chrysler	\$4.29
198557	Cerulean	\$4.79
198561	DuraBlend	\$4.99
198558	Palladium	\$5.99



Tire Guards

Protect tubes from nails, glass, thorns, staples and other sharp objects

If flats are giving you headaches and too many tire repair bills, then use our tire guards to stop all sorts of sharp objects. One-piece, solid rubber, 1/2"-thick tire guard protects inner tube and fits "like a glove". Ideal for mowing operations, street sweepers, scrapyards and waste haulers. Pressure of tube holds tire guard in place. Always use a new tube when installing these guards. **Specify brand of tire and tread design when ordering.** Custom made to fit tire sizes listed. Contact Technical Services at techserv@gemplers.com or 1-800-874-4755 for availability of other sizes not listed.

NOTE: Tire guards are not for highway use.

Item #	Tire Size	Price
TG03	9.5L15	\$112.49
TG05	11L15	\$122.49
TG13	10.00-16	\$127.49
G65612	9.5-24	\$163.49
TG17	11.00-16	\$169.99
G65613	11.2-24	\$174.99
TG06	15x6.00-6	\$53.99
TG10	18x8.50-8	\$65.99
TG09	6.50-16	\$87.49
TG07	6.00-16	\$87.99
G65606	5.50-16	\$97.49
TG11	7.50-16	\$98.49



Versa-Tire Repair Kits

Save money by repairing tires instead of replacing them. Safely and permanently repairs any size puncture on any size/ply tire. Versa-Tire material won't break down or "weep" over time like other rope plugs—repairs last the life of the tire! It's even government tested and used by the United States Department of Defense since 1966. Kits include everything you need to make repairs. Replacement components sold separately. **Medium Kit** – For small-to-medium shop and fleet repair needs. Includes durable, molded plastic case; 240"L rope plug spool; 2.25-oz. bonding compound; reamer tool; 5"L injector tool; and 6" diagonal pliers. **Large Kit** – Features adjustable injection needle tool that repairs higher ply tires for heavy applications. Great for professional repair shops and large-scale fleets. Includes metal storage box; (2) 240"L rope plug spools; 8-oz. bonding compound; reamer tool; leak seeker fluid and bottle; and injector tool. **NOTE:** Not suggested for use with bias-ply tires.

Item #	Description	HM	Price
219518	120" Rope Plug Spool		\$11.49
219526	8-oz. Bonding Compound	▲	\$12.99
219525	Large Kit	▲	\$184.99
219523	240" Rope Plug Spool		\$21.49



Don't let your productivity go flat

Spare yourself time and money—Get Ultraseal™ tire sealant

228245

All three formulas are also available in 5-gal pails.



1-gal. containers include an easy-to-use pump.

G65511

224917



Commercial Grade

- Seals up to 1/4"-dia. punctures in tubeless tires.
- For high-speed vehicles or off-road machinery
- Ideal for cars, ATVs, trucks or farming equipment.

Bulletproof Grade

- Seals up to 1/2"-dia. punctures in tubeless tires.
- For slow-moving vehicles or off-road machinery
- Ideal for farming equipment or military vehicles.

Extreme Grade

- Seals up to 1/2"-dia. punctures in tube AND tubeless tires.
- For high-speed AND slow-moving vehicles or off-road machinery
- Ideal for cars, ATVs, trucks, farming equipment, military vehicles - virtually any pneumatic tire!

**PROBLEM****SOLUTION**

Punctures are sealed instantly and tire maintains the same air pressure.

How Ultraseal Works—Easy As 1-2-3

Release the air pressure from the tire and remove the valve core.

Pump in the recommended amount of sealant.

Install valve core and inflate the tire—now you're ready to roll.

The Other Guys

Spotty coverage is no coverage

Ultraseal Tire Sealant

Conditions tire savings and maintains proper air pressure to protect against tread separation. It improves fuel mileage and permanently seals leaks, resulting in reduced tire wear for extended life. Guards against punctures, flats and blowouts, reducing downtime and improving safety. Inhibits rust and corrosion on steel belts, wheels and rims. Won't freeze or evaporate inside tire for all-weather protection. Water-soluble fluid for easy cleanup. One application lasts the life of the tire. **228245, 228246 and 228247** require an installation pump, sold separately. **NOTE:** Not for ultra-high-performance tires. *Bulletproof Grade is for use on vehicles or machinery with a maximum of 25 mph.*

Item #	Description	Size	Price
1-gal. Container, Pump Included			
G64511	Commercial Grade	1 gal.	\$62.99
G65511	Bulletproof Grade	1 gal.	\$72.99
224917	Extreme Grade	1 gal.	\$76.49
5-gal. Pail, Pump Not Included (sold separately)			
228245	Commercial Grade	5 gal.	\$228.99
228246	Bulletproof Grade	5 gal.	\$264.99
228247	Extreme Grade	5 gal.	\$274.99

Ultraseal Tire Sealant
Completely adheres to tires for even coverage compared to the competition



Large Tire Repair Kit

For use on truck, skid steer and implement tires

Kit is stored in a durable, molded plastic 12"L x 8"W x 2.5"H case and includes one each of the following items: insertion tool, set screw, heavy-duty spreader probe, spare needle, can of lube, Allen wrench and instructions, along with (30) 8"L tire plugs and (2) cutting blades.

Item #	Description	Price
30R	8"L Plug Refills for G60040, Box of 30	\$28.99
PB103	Replacement Can of Lube (for G60030 and G60040)	\$4.99
G60040	Large Tire Repair Kit	\$69.99
10255T	Replacement Needle for G60040	\$7.49



Safety Seal Tire Repair Kit for Small Tires

For cars, ATVs, light trucks, and lawn/garden tractor tires

Kit is stored in a durable, molded plastic 12"L x 8"W x 2.5"H case and includes one each of the following items: insertion tool, set screw, heavy-duty spreader probe, spare needle, can of lube, Allen wrench and instructions, along with (30) 4"L tire plugs and (2) cutting blades.

Item #	Description	Price
R60	4"L Plug Refills for G60030, Box of 60	\$27.99
10255	Replacement Needle for G60030	\$5.79
G60030	Small Tire Repair Kit	\$57.90

- **No Cement** - Repairs are self-vulcanizing
- **Save Labor** - Many repairs can be made without removing the tire
- **Cut Downtime** - Get your equipment back in service quickly
- **Versatile** - Repair irregular cuts as well as round punctures
- **Unbeatable** - No leaks and a break strength exceeding 400 lb.



A Quick Fix In Four Easy-to-Follow Steps . . .



1 Insert rope plug into the needle tool.



2 Insert the needle and rope plug into the puncture until the handle collar touches the tire.



3 Hold the edge of the handle collar and remove the needle from the tire. Your repair is now in place.



4 Trim the excess rope plug and inflate your tire. You're now ready to go.



Use a standard 1/2" drive ratchet and 30mm socket (not included) to bust tire loose

Ram removes bead from rim seat



Manual Bead Breaker

Breaking the tire bead loose from the rim is the most difficult part of changing tires. This versatile, lightweight tool lets you to change tires yourself. This means less downtime (caused by waiting for the service truck to arrive) and lower tire repair bills. Works on small tires, like those mean bead lock ATV wheels, as well as large 20.8 x 38 tractor rears. Breaks the inside and outside beads while the tractor tire/wheel is still mounted on the tractor, or with the tire/wheel laying flat on the ground. Maximum extended ram is 3.5"L.

NOTE: Not for use with pneumatic impact guns.

Item #	Price
145883	\$149.95



Tighten clamp bolt

Tighten push bar bolt to move bead away from rim seat

Heavy-Duty Bead Breaker

For use with 1/2" impact wrench

Super-strong, specially designed ACME threaded bolt lets you bust stubborn beads using a 1/2"-drive ratchet wrench or pneumatic impact wrench. Can be used on most drop-center rims, from small all-terrain vehicles to large rear tractor tires. Works on stiff or soft wall tires. Compact—excellent for working in tight spaces, and the unique design pushes the bead from the rim, rather than the conventional hammering methods. In most cases, it's not even necessary to remove the wheel for making repairs. Heat-treated, chrome molybdenum steel for maximum strength and durability. 2.75"L x 11.25"W x 10.75"H.

Item #	Price
134539	\$619.99



Little Buddy Manual Tire Bead Breaker

Perfect for working on tires without removing the wheels. Works with a wide variety of tires: ATV, golf cart, truck, bus, agricultural and even back hoe tires. Use with an air ratchet or manual wrench (not included).

Item #	Price
224978	\$154.99



Tire-Mounting and Rubber Lubricant

Amber-colored, jelly-like lubricant helps tire beads slide over rims, making mounting and dismounting easier. Can be used in concentrate or mixed 4:1 with water to make 5 gallons of lubricant. Contains rust inhibitor. Also stops rubber squeaks. 8-lb. pail.

Item #	Description	Price
162457	Lubricant	\$26.49
17295	11" L Cotton Applicator Swab	\$4.99



Bead Butter Lubrication

Helps you mount tires quickly and easily

Can be stored on the shelf in your shop or taken along in your service vehicle. Blue liquid concentrate can be used as is or diluted with water in a 2:1 ratio. Rust inhibitors have been added to protect your rims. Also stops rubber squeaks. 1 gal.

Item #	Price
109610	\$17.47



Ken-Tool Slide Hammers

Will break the toughest beads

These universal bead breakers are powerful enough to loosen stubborn beads of large truck tires or tractor rears, yet accurate enough for small lawn and garden tires. Simply place wedge foot between lip of rim and tire bead. The wedge is driven downward on the bead with a striking blow of the ram bar. Heavy-duty slide hammer (Item # 6H) features a spring-loaded floating foot with a rebounding action to help reduce vibration and operator fatigue.

Item #	Description	FO	Price
35924	Medium-Duty Slide Hammer	■	\$185.39
6H	Heavy-Duty Slide Hammer	■	\$247.19

■ Oversize item: additional shipping charges will apply.



Diaphragm Pump

Installs or removes liquid ballast in tires

Eliminates the need to have a service truck come to fill your tires with liquid. Air-powered, self-priming, corrosion-resistant aluminum-alloy pump can transfer up to 25 gpm and can be run dry without harm. Features an on/off air intake valve, regulator, air filter and brass manifold with a switching control valve for easy reversal of liquid transfer. Includes a core ejection tool for quick filling of tires, an easy-to-read pressure/vacuum gauge, a reinforced PVC bypass hose and a user's manual with fill chart. 10'L supply hose features a stainless steel strainer to remove debris and two quick-disconnects. 15'L fill/evacuation hose has one quick-disconnect. Can be operated with a standard air compressor at 40 to 60 psi (do not exceed 60 psi). Pump is compatible with calcium chloride, alcohol, antifreeze, water, waste oil and diesel fuel. 10"L x 14"W x 14"H.

Item #
167881

Price
\$1,019.00



The Original Cheetah® Bead Seating Tool

Not to be confused with low-quality imitations

This portable unit easily seats the most stubborn beads from smaller ATV tires all the way to large 24.5 truck tires. Features a 5-gal. ASME certified tank that is constructed from a heavy-gauge welded steel. The welded tab on the barrel allows it to lock securely on the edge of the rim for better control of air discharge between the tire and wheel. Equipped with three safety features, including a safety release valve that is preset at 160 psi, an on/off ball valve that allows for controlled filling of the tank and a large air gauge that accurately monitors tank air volume.

Magnum Barrel (accessory) – Easy-to-install attachment provides maximum air dispersion and magnifies the impact power of the bead seater by 2–3X, increasing the tire service range.

Item #	Description	Price
134478	Magnum Barrel	\$123.49
6BST	Cheetah Bead Seating Tool	\$264.99

Ready-To-Go Assemblies

Complete hub and spindle assemblies include all new parts. Hubs, spindles, seals, drum pins, bearings, nuts and studs. Just pack the bearings any way. (In all standard 4-, 5-, 6- and 8-wheel agricultural bolt pattern. Replacement parts for the hubs and spindles are readily available.

We do not recommend that you attempt to patch-pieces on hub axles. With so many manufacturers, many of which have gone out of business, you are better off replacing a broken hub or bearing with a complete assembly. You will find that our prices on complete assemblies are much lower than what you will pay for a single replacement part from a local dealer.

LOAD RATINGS – Always make sure that the load capacity of your axle axle, wheel and the moon with it. Check the load walls of tires for maximum load rating. Remember, the maximum load-carrying capacity of any tire/hub/spindle assembly is limited by the load ratings of the least strong component selected.

NOTE: These hub and spindle assemblies conform to all wheel sizes based on 20 mph.

Item #	Hub Pattern	Spindle Size (in.)	Cap. @ 20 mph	Price
Straight Spindle Assemblies				
125677	4 x 3"	1.500"	1,200 lb.	\$82.99
125678	5 x 5-1/2"	1.500"	1,000 lb.	\$99.99
125689	5 x 2-1/2"	1.500"	2,000 lb.	\$99.99
125679	6 x 6"	1.500"	1,000 lb.	\$103.49
125680	6 x 4"	2"	3,000 lb.	\$107.49
125687	6 x 6"	2"	3,500 lb.	\$115.44
125682	8 x 8"	2.125"	6,000 lb.	\$254.99
125683	8 x 8"	2"	7,500 lb.	\$302.49
Bent Spindle Assemblies				
125685	6 x 6"	1.500"	1,000 lb.	\$148.99
125684	6 x 6"	2"	3,500 lb.	\$146.99

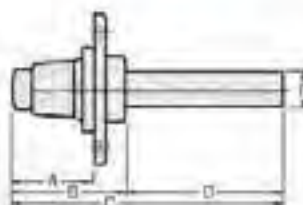

Compare letters in diagrams to table description below

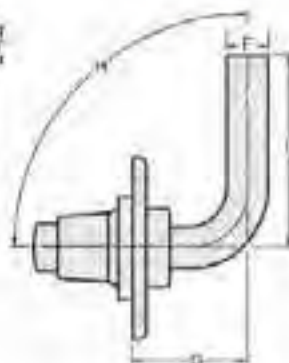

ASSEMBLY DIMENSION DATA

Item #	Description	A	B	C	D	E	F	G	H
125677	1500A 4-Hole Straight	4"	1.500"	3"	1.500"		1.000"		
125678	1500B 5-Hole Straight	5-1/2"	1.500"	3"	1.500"		1.000"		
125689	1500A 5-Hole Straight	2.500"	1.500"	12.000"	6.500"		1.000"		
125679	1500B 6-Hole Straight	6.000"	1.500"	4.000"	1.500"		1.000"		
125685	1500A 6-Hole Bent	1.500"	1.500"	6.000"	1.500"	4.000"	1.000"	7"	6.000"
125680	1500B 6-Hole Straight	2.500"	2.000"	7"	1.500"		2"		
125687	1500A 6-Hole Straight	2.500"	2.000"	14.000"	8.000"		2"		
125684	1500A 6-Hole Bent	2.500"	2.000"	4.000"	1.500"	4.000"	2"	1.500"	6.000"
125682	1500B 8-Hole Straight	1.500"	2.125"	14"	1.500"		2.000"		
125683	1500B 8-Hole Straight	6.000"	2.000"	14"	2.125"		2"		

High-Speed Hub and Spindle Assemblies

These high-speed steel axle assemblies fit many popular Ford and Chrysler wheels. (All the mounted tire/wheel assemblies sold below. Each assembly includes hub, spindle and pins as shown. Pictured at right is one spindle and hub plus parts. **NOTE:** High-speed return brakes on all wheels on duals with GVW exceeds 1,500 lb. when loaded on highway. Check local regulations for your requirements.



Item #	Description	Hub Pattern	Capacity	Hub Length	Spindle	Price
125673	Most 4-Hole Trailer Wheels	4 x 4"	1,000 lb.	4"	1.500"	\$47.99
125674	Most Ford/Chrysler wheels	5 x 4-1/2"	1,000 lb.	4"	1.100"	\$49.99
125675	Most Ford/Chrysler wheels	5 x 4-1/2"	1,500 lb.	5-1/2"	1.500"	\$78.99
125676	4-Wheel Drive GMC's, etc. Wheels	6 x 5-1/2"	1,750 lb.	5-1/2"	1.500"	\$81.49



Clamp-Type Rim

Shown above: how to measure a clamp-type rim



Clamp-Type

Double Mounting Bevel



Flat Base

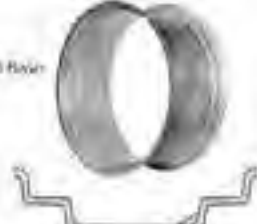

Replacement Rims

NOTE: When ordering a replacement rim, always measure width of both rims and check the size.

Item #	Description	Rim Size	Eye Top Size	Bottom Circle of Clamps	Price
WB-24	Flat Base	8-24	9 1/2 x 24		\$134.99
RW1024	Flat Base	10-24	11 1/2 x 24 x 24		\$139.99
142610	Flat Base	12-24	13.0 x 14.8 x 24		\$164.99
RC1028	Clamp Type 8 1/2" clamp	10-28	11 1/2 x 28	24 LRV	\$229.99
145925	Flat Base	12-24	13.0 x 24		\$257.99
WZB1238	Double Mounting Bevel	12-38	15.6 x 12 x 38		\$349.99
WZB1634	Double Mounting Bevel	16-34	18.4 x 34		\$379.99
WZB1638	Double Mounting Bevel	16-38	18.4 x 38		\$449.99

TRACTOR DUALING PARTS



L-Type Rail Bracket Clamp

Fits on Retainer™ L-type rail, welded to eye. Designed for 24" J-hooks. Requires 3/4" nut and spherical washer (item # PSW34) (sold).

Item #	Price
PA26	\$11.49



T59



TE9

T-Rail Clamps

Snap-on Clamp - Fits MSW™ T-Rail type dual rim.

Economy Clamp - Requires 3/4" nut and spherical washer (item # PSW34) (sold).

Item #	Description	Price
T59	Snap-On Clamp	\$46.99
TE9	Economy Clamp	\$31.99

"Over-the-Rim" Dual Setups

Item #	Description	Price
OSC16	Over-the-Rim Snap-On Clamp	\$51.99
OEC26	Economy Clamp	\$38.99



OSC16

OEC26

Item #	Description	Price
EYE-CR51HF	1/2" Coarse Thread	\$13.49
EYE-CR52	5/8" Coarse Thread	\$11.49
EYE-CR534	3/4" Coarse Thread	\$11.49
EYE-CR578	7/8" Coarse Thread	\$12.99
EYE-FIN56	5/8" Fine Thread	\$11.49
EYE-FIN78	7/8" Fine Thread	\$12.99
EYE-IRMM1PS	Stream Thread with 1 PSW34	\$11.99

IPPS58 This eyelet is designed for use on tractors with power shift axles. Simple bolt-in installation - no welding required.

J-Hook Bolts

Item #	Hook Bolt Length	Price
H8	8"	\$18.49
H12	12"	\$18.99
H16	16"	\$19.49
H20	20"	\$17.99
H22	22"	\$18.99
H24	24"	\$18.99
H26	26"	\$21.49
H30	30"	\$21.49
H36	36"	\$27.99

Item #	Description	Price
PSW34	3/4" Spherical Washer for J-Hooks	\$5.29
PNC34	3/4" Nut for J-Hooks, Coarse Thread	\$3.29



EYE

IPPS58

PSW34

PNC34

H12



G11020

G92591

Replacement Hardware for Clamp-Type Rims

Carriage Bolt Assembly - 1/2" NC x 1-1/4" bolt with nut and lock washer bolts dia to rim.

Weld-in Rim Clamp - Lighter clamp activates 20-24" axle clearance on flat base rim or 26-32" bolt inches on 24" flat base rim.

Item #	Description	Price
G11020	Carriage Bolt Assembly for Clamps	\$12.79
G92591	Weld-in Rim Clamp	\$21.49



Bottle Jacks

Durable, yet economical steel hydraulic bottle jacks are ideal for changing tires or repair work in your garage, shop or even out in the field. These side-pump jacks are designed for vertical use only. Include pump handle.

Item #	Lifting Capacity	FO	Price
214893	100,000 lb.	■	\$134.99
214881	4,000 lb.		\$15.99
214882	8,000 lb.		\$18.99
214883	12,000 lb.		\$22.99
214884	16,000 lb.		\$28.99
214885	20,000 lb.		\$33.99
214886	24,000 lb.		\$36.99
214889	40,000 lb.		\$49.99
214892	60,000 lb.		\$99.99

■ Oversize item: additional shipping charges will apply.



Floor Jacks

Rugged floor jacks provide an economical lifting solution tough enough to handle trucks and SUVs. 360° swiveling rear casters make them easy to move about your shop. Handle on **Item # 171599 is 24.5"L**. **Item # 171600 with foot-pedal adjustment sets the lift height with just one pump. 40"L handle.**

Item #	Max Lifting Height	Min Lifting Height	FO	Price
171600	19-11/16"	5-11/16"	■	\$135.99
171599	17-1/4"	6"		\$76.99

■ Oversize item: additional shipping charges will apply.



MoJack Mower Lifts

Provide better undercarriage access

ZR – Scissor lift for most residential riding lawn mowers and zero turns. **EZ** – Engineered to lift most residential riding mowers including zero-turning radius models. **EZ Max** – All the features of the EZ, plus a unique clutch system for easy lifting and an automatic safety system. **XT** – Lift any riding mower or lawn tractor on the market, including small zero-turning models. **PRO** – Larger capacity is perfect for ZTR-type models.

Item #	Max Lifting Height	Lifting Capacity	Outside Span of Front Tires	Model	Lift Mechanism	FO	Price
223661	20"	250 lb.	34" to 43.5"	ZR	Scissor Jack		\$175.99
175144	24"	300 lb.	35.5" to 47.5"	EZ	Screw Jack	■	\$229.99
223662	24"	450 lb.	37" to 47.5"	EZ Max	Screw Jack	■	\$242.99
182104	25"	500 lb.	31.5" to 62.5"	XT	Screw Jack	■	\$354.99
175145	28"	750 lb.	31.5" to 62.5"	PRO	Self-Braking Winch	■	\$549.99

■ Oversize item: additional shipping charges will apply.



Inflation Gauge

Single button control. Calibrated 10–120 psi. 1/4" FNPT inlet. Includes clip-on air chuck and bleed-off valve.

Item #	Length	Price
30A	3'	\$53.99
HI405	6'	\$57.99



Clip-On Air Chuck

Easy/sure grip chuck for regular air lines

Locks into cap threads of valve stem when sliding sleeve is pushed to the forward position. Easily releases when sleeve is pulled back. 1/4" female NPT thread.

Item #	Price
G27273	\$15.49



Digital Tire Pressure Gauge

Features a tough rubber boot that surrounds and protects the LCD. Gauge reads in 0.5-psi increments, operating range 0–160 psi. Accurate to within ±0.3 psi. Auto shutoff preserves battery life. NOTE: Not for use with liquids.

Item #	Price
127627	\$64.99



Pencil-Type Tire Gauges

One tire gauge does double-duty.

Item #	Description	Price
G925	Passenger Tire Air Gauge	\$6.49
G7229	Low-Pressure ATV Air Gauge	\$7.99
8D	Air/Liquid Tire Gauge	\$8.49
M923	Straight Chuck Tire Gauge	\$8.79



Dual Truck Tire Gauge

Fits in your shirt pocket

Measures 20–120 psi in 2-lb. increments on two sides and kilo Pascals (kPa) 120–820 in 20 kPa increments on the other two sides. 5.5"L.

Item #	Price
M927	\$11.79

Tire Gauge and Lock-On Air Chuck for Aluminum Wheels

Air chuck is 6"L and has 1/4" female threads. Gauge has an easy-to-read nylon indicator bar with hang-up ring. Calibration of 10–150 psi in 2-lb. increments.

Item #	Description	Price
AC10	Lock-On Air Chuck	\$11.99
TG18	Tire Gauge	\$19.49

GEMPLERS

Extend the life of tools and equipment with Rust Converter

Historic Church Bell Restored

"In June 2002 the Tonset Historic Church was struck by lightning. The bell tower and narthex were destroyed by fire. The church bell fell 35 feet onto the floor of the narthex. When it was decided to rebuild the church, the bell was removed from the burned structure. I used Gempler's Rust Converter on the badly rusted bell and had very good results. The bell was replaced in the newly rebuilt steeple and bell tower, and is expected to remain rust free for many years." Sam, Lignite, ND



BEFORE

AFTER



Rust Converter FAQs: Do you have to paint over Rust Converter?

No. Although you do not have to paint after the Rust Converter applications, it is recommended to apply a high-quality oil-based paint if the item will be stored outdoors. Surfaces protected with Rust Converter and an oil-based paint system resist weather, sunlight, rain and even salt spray without peeling or cracking. More FAQs online at gemplers.com

GEMPLERS® Rust Converter seals out moisture to prevent future rusting

No sandblasting, heavy scraping or grinding is necessary. Easy to use and easy to clean up. Paint over with oil-based paint. Environmentally safe, non-flammable. **NOTE:** Do not allow Rust Converter to freeze.

Paint-On Rust Converter

Requires two coats. Irregular, porous or textured surfaces may require more coats. 1 gal. covers 500 sq. ft. Nine-month shelf life.

Sprayable Rust Converter

Ideal for automotive W/P or airless sprayers. Requires three coats for optimum coverage. 1 gal. covers 300 sq. ft. Nine-month shelf life.

Aerosol Spray-On Rust Converter

Requires four coats for optimum coverage and protection. One can covers 24 sq. ft. One-year shelf life.



Paint-On, 1 qt.	# RCQ	\$15.79
Paint-On, 1 gal.	# RCG	\$52.79
Sprayable, 1 gal.	# 219651	\$52.79
Aerosol, 13.6oz.	# 127787*	\$9.49

*Requires special handling due to DOT regulations. Additional shipping charges will apply. Cannot be shipped by air.



Now you see it (rust)



Now you don't. Easily paint or spray onto rust and watch it convert like magic.



No grinding or sandblasting. Wire brush-off loose rust. Apply directly on surface.

Reacts with rust to form an inert black barrier that prevents future rusting.

Simply apply oil-based paint over Rust Converter to restore valuable tools and equipment.

KIT INCLUDES:

- 1 1-gal. Rust Converter
- 2 oz. Polypropylene Pail
- 4 mil Disposable Nitrile Gloves, Powdered, 100/box
- 1 Safety Glasses, Clear Lens
- 1 Steel Wire Brush
- 1 2"W Paint Brush



GEMPLERS® Rust Converter Kit

Start restoring your investments

Kit includes everything you need to prepare surfaces for conversion, the Rust Converter itself and necessary personal protective equipment to help keep you safe in the process. Contents sold separately.

Item #	Description	Price
230151	Rust Converter Kit with Large Gloves	\$67.99
230152	Rust Converter Kit with XL Gloves	\$69.99
Kit Refills/Replacements		
RCG	1-gal. Rust Converter	\$52.79
PP2Q	2-oz. Polypropylene Pail	\$10.49
198256*	4-mil Nitrile Gloves, Powdered, 100/box	\$10.99
214512-CLR	Safety Glasses, Clear Lens	\$3.99
230061	Steel Wire Brush	\$4.29
230057	2"W Paint Brush	\$1.49

*Choose from glove sizes M, J&L, 6-10, 11-12.





GEMPLERS Rust Remover

Safe and effective way to remove rust without scrubbing

Made from a pH-neutral formula that is nontoxic, biodegradable and nonflammable. Has rust-inhibitor additives that will resist rust. Works on heavily pitted metal. Simply clean off excess dirt and grease, then submerge rusty item in the solution. Soak time depends on the severity of the rust. Will not harm surfaces made of rubber, plastic, vinyl, PVC, aluminum, copper or brass. Once treated, simply rinse with water, then air or towel dry the item. Can be reused until no longer active.

Item #	Shop Supplies: Size	Price
227050	1 gal.	\$21.49
227051	5 gal.	\$73.49



Rust Preventive

Highly protective, non-drying film penetrates and protects to prevent rust. Unique gel formula breaks through heavily corroded and/or frozen parts, such as nuts, bolts and shafts. Easily apply with airless spray equipment, brush, roller or aerosol can. Prevents oxidation caused by fertilizers, herbicides, pesticides and salts. Will not harm paint, synthetic rubber, plastic or burn greenery. Nontoxic and nonhazardous.

Item #	Description	HM	Price
173087	8-oz. Can with Brush		\$11.49
173088	12-oz. Aerosol Can	▲	\$12.99
219480	12-oz. Pump Can		\$15.99
173089	5-gal. Pail		\$205.99
G55625	1-gal. Can		\$51.49

▲ Requires special handling due to DOT regulations.



Rust Remover

Eliminate rust in minutes ... without scrubbing

Environmentally safe, water-based and proven to make rust—even deep, pitted rust—disappear in minutes! Restore rusted steel tools and auto parts to “like-new” condition. To use, completely cover the rusted object with Evapo-Rust. Immerse for 30 minutes for light rust, overnight for heavy rust. Rinse with water, and you're done! Biodegradable, nontoxic, noncorrosive, nonflammable and contains no acids, alkalis or petroleum solvents.

NOTE: Metal should not be immersed in Rust Remover longer than necessary, 24 hours at the most. Otherwise, a dark carbon layer may build up on the steel.

Item #	Size	Price
160263	1 qt.	\$11.49
160264	1 gal.	\$27.99
160265	5 gal.	\$99.99



RUST-OLEUM Red Marking Chalk

Red Marking Chalk has a fast-dry formula for temporary marking applications

This Red Marking Chalk has a fast-dry formula for temporary marking applications.

Note: not for sale in (AL;GA).

Item #	Color	HM	Price
109936	Red	▲	\$5.89
109937	Blue	▲	\$5.89
109938	White	▲	\$5.89
109935	Yellow	▲	\$5.89
109939	Green	▲	\$5.89
109940	Orange	▲	\$5.89

▲ Requires special handling due to DOT regulations. Additional shipping charges will apply. Cannot be shipped by air.











NEW

RUST-OLEUM V2100 System Enamel Spray Paint

This spray paint has an advanced formula that provides the best-possible corrosion protection with easy, one-coat coverage and long-lasting color, gloss and durability. Tough, professional finish for superior resistance to chipping, cracking and peeling. High-output tip covers 50% faster; dries in only 20 minutes to touch. Withstands heat to 200°F. Most colors match the 7400 or V7400 System for convenient touch-ups. Meets USDA requirements for incidental food contact; accepted for use in federally registered Canadian food facilities; VOC-compliant nationwide. 15-oz. spray can.

Item #	HM	Price
V2100	▲	\$9.99

▲ Requires special handling due to DOT regulations. Additional shipping charges will apply. Cannot be shipped by air.

	Gloss Black		Safety Orange
	Gloss White		Bright Red
	Flat Black		Dark Machine Gray
	Silver Aluminum		Safety Blue

**USA
MADE**

Zero-Rust® Industrial Primer

All-in-one sealer, rust preventer, primer and top coat

One gallon typically covers 280–300 sq. ft.
NOTE: Top coat may turn to a chalky/flat surface and color will fade if exposed to direct UV rays (though the rust resistance/performance is not affected).

Note: not for sale in (AL;GA).

Item #	Color	Shop Supplies : Size	HM	Price
223672	Black, Gray, Red Oxide, Safety Blue, White, Yellow	12 oz.	▲	\$12.99
223673	Black, Gray, Red Oxide, Tide Green, White, Yellow	1 qt.	▲	\$34.99
223675	Black, Gray, Red Oxide, Tan, White, Yellow	1 gal.	▲	\$69.37





Spillyter® Extra-Strong Sorbent Pads

Will not tear even when fully soaked

Soak up those messy leaks or spills from machinery and equipment. Polypropylene is surrounded by a tough spunbound cover that won't tear or break apart even when walked on, driven over or used on rough terrain. Gray pads absorb all liquids, including oil. Each pad is 16" x 18" and absorbs up to 29 oz. Pkg. of 100 pads.

Item #	Description	Qty./Pkg.	Price
97133	Gray Pads	100	\$77.99



Crude Control™ Oil Drain Pan

Perfect for changing oil on large vehicles

Recycle oil without the mess or hassle. Portable drain pan catches everything and seals tight for transport or storage. Center draw plug accepts 58 quarts of oil and corner screw vent ensures smooth filling and pouring. Four large handles simplify carrying and pouring. Two heavy-duty, built in casters for easy maneuverability. Heavy-duty polyethylene. 36"L x 26"W x 9.5"H.

Item #	Price
162109	\$97.99



CMAN NUT LOCK Commercial-Grade Oil Filter Pliers

Remove oil filters quickly and easily. Made of heavy-duty steel and features a multi-position tongue-and-groove handle that easily adjusts to grab onto a variety of oil filters. Cushioned handle and plier's teeth ensure a firm grip and the necessary torque you need to remove the slickest filters. Right-angle plier is ideal for changing smaller filters in tight locations and can even be used on PVC pipe.

Item #	Length	Jaw Opening	Price
134311	9"	1.75" to 3.5"	\$18.69
173163	12"	2.75" to 4.25"	\$24.99
230148	12"	2.5" to 3.75"	\$26.99
173164	15"	2.5" to 5.5"	\$29.99



LiquiVac™ Oil Changing System

Simple, no-mess way to change your oil

Fast, convenient and environmentally safe. User-friendly system creates a powerful vacuum that draws the used oil out of the engine and into a holding tank for easy disposal at a recycling center. Portable, hand-pump device drains large engines with narrow dipstick tubes in 8–10 minutes—no electricity required. And no fiddling with inconvenient drain plugs. It's just the right size to handle quick maintenance on cars, light trucks, tractors and boats. Includes two 0.25" O.D. hoses that can be connected with a spacer. 2-gal. reservoir capacity.

Item #	Price
198483	\$52.99



TuffTop Canopies

Easy to fold down or quickly remove

Hard canopies block the sun and can be folded or removed in seconds without tools. Powder-coated strong steel frame supports panels made of 0.15"-thick high-density polyethylene (HDPE) with a laminated UV solar cap for long life. 44"L x 44"W (Item # 219715) and 52"L x 48"W (Item # 219716) both fit 2" square or 2" x 3" ROPS. Fit most tractors and zero turns. Adjustable fit for forward-leaning, vertical or rear-leaning ROPS. Specify color: Grey, Green, Orange, Red.

Item #	Shop Supplies: Size	FO	Price
219715	44"L x 44"W	■	\$259.99
219716	52"L x 48"W	■	\$284.99

■ Oversize item: additional shipping charges will apply.



ROPS Umbrella Kit

This easy-to-install umbrella attaches to almost any ROPS rollover protection bar without any drilling. 54" umbrella is made from a heavy-duty, 10-oz. double-stitched cotton duck canvas with reinforced corners and steel grommets. Universal, steel mounting bracket uses four clamping bolts that can be mounted to ROPS structures from 2" x 2" to 3" x 3" for a secure hold. Lock pin connection lets you easily remove the umbrella for transporting your mowers and equipment. Kit comes complete with canvas cover, umbrella frame and mounting bracket. Specify color: Orange, White, Yellow. NOTE: Umbrella cannot be used on a ROPS with more than an 11° tilt.

Item #	Price
145717	\$113.99



Folding Buggy-Top Canopy

Rotates 180° for forward and backward shade

Enjoy simple installation and a wide 48" adjustable shade area. Fits most agricultural, construction and commercial equipment as well as most ROPS. Included fender-mount brackets require drilling. Don't want to drill into fenders? Try the optional axle-mount kit (Item # 219722). Frames are made of yellow-dichromate-zinc-plated steel for a durable, corrosion-resistant finish. Water-resistant canvas cover. Specify color: Blue, Orange, Red, White, Yellow.

Item #	Price
219719	\$165.99

Model	Manufacturer Number	Item #	Price
ROUND CABS (1977-1985) (requires 2 filters; mnts. inside, rear); SQUARE CABS (Series 2) 7710-8830 (requires 2 filters)	D8NN94000-N20CA	FR85H	\$199.99
SQUARE CABS (Old style, prior to 1977) 8000-9600	D3NN19-N551A	FS77H	\$199.99
TL Series: TL70, TL80, TL90, TL100 (requires 2 filters); TS Series: TS90, TS100, TS110 (Before SN139306) (requires 2 filters)	82014790	FS93H	\$199.99
TM Series: 120, 130, 140, 155, 175, 190 (newer version) (requires 2 filters); TS Series: TS90, TS100, TS110 (After SN139307) (requires 2 filters)	82014824	FS94H	\$199.99
TN Series: TN55, TN65, TN70, TN75, TN80F, TN90 (requires 2 filters)	44910397	FS98V	\$199.99
TN "FA" Series: TN75FA, TN85FA, TN95FA (requires 2 filters)	47135041	134521	\$199.99
HAGIE SPRAYERS			
250, 280, 284 (Before 1998), (2.19"x22"x4")		HA91V	\$199.99
INTERNATIONAL HARVESTOR			
1066, 1466, 1566	537268R2	TA90V	\$214.00
186-Hydro, 786, 886, 986, 1086, 1486, 1586, 3088, 3288, 3388, 3488, 3588, 3688, 3788, 5088, 5288, 5488, 6388, 6588, 6788, 7288, 7488 COMBINES: 1420, 1440, 1460, 1480, 1620, 1640, 1660, 1680	143481C2	CI86H	\$199.99
JOHN DEERE			
TRACTORS: 2140, 2150, 2250, 2350, 2450, 2550, 2650, 2750, 2850, 2940, 2950, 3150, 2255, 2355, 2555, 2755, 2855, 2955, 3055, 3155, 3255, Soundguard Cabs, 4030, 4230, 4430, 4630, 4040, 4240, 4440, 4640, 4840, 4050, 4250, 4450, 4650, 4850, 4055, 4255, 4455, 4555, 4755, 4955, 8430, 8440, 8630, 8450, 8640, 650, 8850, 4560, 4760, 4960. COMBINES: 6620, 6622, 7720, 7722, 8820. SPRAYERS: Hi-Cycle™ Sprayers 6000, 6500	RE12793, AR61903, L38598, or RE12793	JD30V *	\$199.99
5000 Series: 5200, 5300, 5400, 5500, 5210, 5310, 5410, 5510 (requires 2 filters)	RE64913	JD50V	\$199.99
5000 "20" Series: 5220, 5320, 5420, 5520 (older version before SN 420000) (requires 2 filters)	RE73220	134127	\$348.00
5000 "N" Series: 5200N, 5300N, 5310N, 5320N, 5400N, 5325N, 5420N, 5425N, 5500N, 5510N, 5520N, 5525N. 5000 "EN" Series: 5083EN, 5093EN, 5101EN.	AL111748, AL119095	JD52V	\$199.99
6000 Series with serial # under 282980 (requires 2 filters)	AL76555	JD62V	\$199.99
6000 Series with serial # 282980 and above (requires 2 filters); 7000 "20" Series: 7220, 7320, 7420, 7520 (requires 2 filters)	AL119096	JD63V	\$199.99
7000 Series: 7200, 7400, 7600, 7700, 7800, 7210, 7410, 7610, 7710, 7720, 7810, 7820, 7920; 8000 Series: 8100, 8200, 8300, 8400, 8110, 8210, 8310, 8410 (not for track models)	RE24619	JD60R	\$199.99
Adaption Kit (required for initial installation of JD60R)		JD80KIT	\$74.99
8000 Track Series: 8300T, 8400T, 8520T (NH3 not available)	R119168	126003	\$199.99
60 & 70 Series 4-wheel drive: 8560, 8760, 8960, 8570, 8770, 8870, 8970	RE24619	JD60R	\$199.99
COMBINES: 3300, 4400, 5200, 5400, 5440, 5460, 5720, 6600, 6602, 7700	AH80920	JC90V	\$199.99
COMBINES: 9400, 9410, 9450, 9500, 9510, 9600, 9610, 9650, 9750	AH115833	JD95R	\$229.99

* For anhydrous ammonia filters that take JD30V use: JD30VNH

Model	Manufacturer Number	Item #	Price
KUBOTA			
L4200, L3710, L4310, L4610, L3430, L4330, L4630, L5030, L5740, M105, M105S, M4900, M5700, M6040, M6800, M8200, M9000, M9540	TA043-71600	173297	\$199.99
M5950, M6950, M7950, M8950, M8580 (requires 2 filters)	36919-50311	173298	\$199.99
M110, M120 (requires 2 filters)	52241-21650	173299	\$199.99
M8200N, 8540HDNBC, M7040HDNBC	W2336-71600	173300	\$229.99
M108X, M110X	52241-21650	173301	\$199.99
MASSEY FERGUSON			
1500, 1505, 1800, 1805	259707M1	MF91V	\$199.99
698, 699	3.302.666M91A	MF96V	\$199.99
375, 390, 390T, 393, 398, 399	3478477M91	MF97V	\$199.99
8400 Series: 8450, 8460, 8470, 8480	3786649M1	134523	\$199.99
McCORMICK			
CX80, CX75, CX85, CX90, CX95, CX100, CX105	248124A1	C197V	\$199.99
MERTZ SPRAYERS			
Most Models (2.19"x33"x5")		MZ90H	\$199.99
SPRAY COUPE			
Most Models (2.57"x28"x7.5)		SC94V	\$199.99
TERRAGATOR			
Most Models (2.19"x38"x5")		TA90H	\$199.99
WILLMAR			
Older models		WM96H	\$199.99
Air Ride		FS85H	\$199.99
Eagle-New		JD30V *	\$199.99
WHITE			
6065, 6085, 6105		AA90V	\$199.99
4-150, 4-225, 85, 100, 105, 120, 125, 135, 140, 160, 170, 180, 185, 195, 285, 6124, 6125, 6144, 6145, 6175, 6195, 6215		WH90H	\$229.99
6410, 6510, 6710, 6810, 8310, 8410, 8510, 8610, 8710, 8810		MF94V	\$199.99
Older models (inside mount)	30-3175154	WH91V	\$199.99
WALKER			
44		JD95R	\$229.99
YEAR-ROUND CABS			
All models		YC90V	\$199.99

* For anhydrous ammonia filters that take JD30V use: JD30VNH



Polypropylene Towing Rope With One Loop And One Hook

Similar to the polypropylene Towing Rope shown above, but featuring one loop and one hook.

NOTE: Never attach rope to a chain or to any attachment point with a lower rated strength than the original rope.

Item #	Length	Diameter	Applications	Rated Capacity	Price
163113	30'	1-5/8"	3/4 Ton-and-Larger Trucks	37,500 lb.	\$172.19
163109	20'	1"	Trucks/Cars	12,500 lb.	\$57.99
163111	20'	1-3/8"	1/2 Ton 4x4 Trucks	25,000 lb.	\$83.99



Polypropylene Towing Rope With Two D-Rings

Offers many advantages over other towing ropes and straps, including lighter weight, chemical resistance and less stretch. Polypropylene rope only stretches 10–14% of its length, unlike other types of rope that can stretch up to 40%. This reduces dangerous recoil if the rope ever breaks. Resists chemicals, such as diesel fuel, battery acid, oil, gasoline, hydraulic fluid and fertilizers. UV resistant. D-ring connection on each end of rope.

NOTE: Never attach rope to a chain or to any attachment point with a lower rated strength than the original rope.

Item #	Length	Diameter	Applications	Rated Capacity	FO	Price
163115	30'	2"	Large 2-Wheel Drive Tractors	50,000 lb.		\$278.79
163117	30'	2-1/2"	Large 4-Wheel Drive Tractors, Semis	75,000 lb.		\$331.99
163119	30'	3"	Combines and Fertilizer Spreaders	100,000 lb.	■	\$461.99

■ Oversize item: additional shipping charges will apply.



Hand Cranked Winch with Automatic Brake

Self-activating disc brake system holds load in position when the handle is released. Solid carbon-steel gears and embossed, reinforced base for extra strength. Heavy-duty, 7"L steel handle has molded grip. Powder-coated bronze finish. Gear ratio 4.4:1 and reel capacity 68'L x 3/16"-dia. cable. Measures 6-11/16"L x 6-1/4"W x 5-1/2"H.

Item #	Price
173161	\$59.99
173162	\$59.99



Twist Lock™ Grab Hook Chain Assemblies

Grade 70 Chain

Include a Twist Lock™ grab hook that, once locked in place, will not come loose from the attachment point. Grade 70 chain meets every application, from chain-to-chain hooking to tie downs and vehicle stabilization. Prevent inadvertent re-hooking.

Item #	Length	FO	Price
217213	20'		\$100.99
217214	10'		\$110.99
217216	20'	■	\$180.99
217208	10'		\$53.99
217211	10'		\$65.99
217210	20'		\$77.99
217212	15'		\$83.99

■ Oversize item: additional shipping charges will apply.



Twist Lock™ Grab Hook Chain Assemblies

Grade 80 Chain

Include a Twist Lock™ grab hook that, once locked in place, will not come loose from the attachment point. Grade 80 chain meets every application, from chain-to-chain hooking to tie downs and vehicle stabilization. Prevent inadvertent re-hooking.

Item #	Length	Shop Supplies: Size	WLL	FO	Price
217221	15'	3/8"	7,100 lb.		\$110.99
217222	20'	3/8"	7,100 lb.		\$140.99
217224	15'	1/2"	12,000 lb.		\$182.99
217225	20'	1/2"	12,000 lb.	■	\$225.99
217217	10'	5/16"	4,500 lb.		\$76.99
217220	10'	3/8"	7,100 lb.		\$82.99
217218	15'	5/16"	4,500 lb.		\$99.99

■ Oversize item: additional shipping charges will apply.



Grade 70 Binder Chain

Steel chain assemblies are excellent for load binding, logging, towing and hauling. All feature a secure clevis grab hook on each end for attaching or shortening the chain.

NOTE: Binder chain is not to be used for overhead lifting.

Item #	Length	Shop Supplies: Size	WLL	FO	Price
173223	15'	1/2"	11,300 lb.		\$108.99
173225	10'	5/8"	15,800 lb.		\$130.99
173224	20'	1/2"	11,300 lb.	■	\$137.99
173216	10'	5/16"	4,700 lb.		\$32.99
173219	10'	3/8"	6,600 lb.		\$38.99
173217	15'	5/16"	4,700 lb.		\$40.99
173220	15'	3/8"	6,600 lb.		\$52.99
173218	20'	5/16"	4,700 lb.		\$52.99
173221	20'	3/8"	6,600 lb.		\$68.99
173222	10'	1/2"	11,300 lb.		\$72.99

■ Oversize item: additional shipping charges will apply.



J-Hook Bolts

J-hook bolts are made of hardened steel with 3/4"-thick stock. Length is measured from inside of hook to end of the threads.

Item #	Length	Price
H20	20"	\$17.99
H8	8"	\$18.49
H22	22"	\$18.99
H12	12"	\$18.99
H24	24"	\$18.99
H16	16"	\$19.49
H30	30"	\$21.49



Over-the-Rim Dual Setup Clamps

Used on clamp-type, "over-the-rim" dual setups.

Item #	Description	Price
OEC26	Economy Clamp	\$38.99
OSC16	Snap-On Clamp	\$51.99



Eyenuts for Dual Setups

Eyenuts for securing duals are electroplated with a rust preventative finish for added protection. Item # IPPSR is designed to be used on tractors with power shift wheels - simple bolt-on installation, no welding required.

Item #	Description	Price
EYE	3/4" Course Thread	\$11.49
EYE	5/8" Course Thread	\$11.49
EYE	5/8" Fine Thread	\$11.49
EYE	18mm Thread with 1.5 Pitch	\$11.99
EYE	7/8" Course Thread	\$12.99
EYE	1/2" Course Thread	\$13.49
IPPSR	For Power Shift Wheels	\$26.99



Nut and Washer for J-Hooks

Item # PNC34 is a 3/4" coarse thread nut. Item # PSW34 is a 3/4" spherical washer.

Item #	Description	Price
PNC34	Nut	\$3.79
PSW34	Washer	\$5.29



Balldog Plus™ Hitch Attachment

Outfits your receiver hitch with multiple anchor points

To establish convenient anchor points for pulling or towing, patented Balldog slips over your trailer ball (1-7/8", 2" and 2-5/16") using a pear link that you secure by inserting included pin. Or, it fits into a receiver tube (2" and 2-1/2") using the oblong link. The Twist Lock™ hook prevents accidental release of chain from hook. Great for securing chain, tow ropes, wire rope, etc. Working Load Limit is 4,700 lbs.

NOTE: Not for overhead lifting.



Item #	Price
219733	\$44.99



Low-Profile LED Mini Bar Light

High-impact, durable construction with bright LEDs. Features a clear dome with amber LEDs. Cycles through three pre-programmed patterns for better visibility. Magnetic mount version uses a 15'L switched plug power cord with on/off switch that allows user to remove or transfer between vehicles. 12/24V operation. 1.4A max draw. 17-1/2"L x 2-3/4"H x 9-3/8"D.

Item #	Mounting	Price
215056	Permanent	\$263.29
215057	Magnetic	\$286.39



Bright LED Lights

Visible from more than 1 mile away. Ideal for marking trailers, vehicles and implements. With a push of a button, these lights switch between flashing or steady mode. Up to 24-hour runtime on (4) AA batteries (not included). 6"W x 4"H. Choose from standard magnetic base or pivoting magnetic base. NOTE: Batteries not included.

Item #	Mounting	LED Color	Price
125691	Standard Magnetic	Amber	\$30.99
125692	Standard Magnetic	Red	\$30.99
125994	Pivoting Magnetic	Red	\$35.89
125993	Pivoting Magnetic	Amber	\$35.89



Low-Profile Strobe Mini Bar Light

Powerful yet economically priced

High-impact, durable construction to protect against shock and vibration. Amber Fresnel lenses utilize two microburst quad flash strobes in an alternating quad flash pattern for high-light output. Magnetic mount uses a 15'L switched plug power cord with on/off switch, which allows the user to remove or transfer between vehicles. 12/24V operation. 1.5A max draw. 17.25"L x 2.75"H x 9.5"D.

Item #	Price
219504	\$224.99



Heavy-Duty Booster Cables

Parrot-jaw, heavy-duty, 500A clamps fit top and side post batteries. The copper cable is coated with rubber insulation that stays flexible to -67°F. Individually inspected before leaving the factory. Select from 4-ga., mechanic's-grade booster cables or 2-ga., trucker's-grade booster cables. NOTE: Item # 145893 does not come with a hard case.

Item #	Cable Length	Cable Gauge	Price
145894	20'	2	\$146.99
145893	16'	4	\$85.99



Rescue® Battery Power Packs

RESCUE 950 – Features 12V power, an air compressor with hose and a built-in gauge.

RESCUE 1800 – High-current booster with large reserve capacity for longer intervals between charging. **RESCUE 2100** – Heavy-duty commercial unit workhorse.

Accommodates both 12V and 24V vehicles and equipment.

Note: not for sale in (AL;GA).

Item #	Description	HM	Price
223678	Rescue 950	▲	\$184.99
223679	Rescue 1800	▲	\$286.99
223680	Rescue 2100	▲	\$356.99

▲ Requires special handling due to DOT regulations. Additional shipping charges will apply. Cannot be shipped by air.



Battery Chargers/ Maintainers

Consistently and safely deliver the optimal battery charge for all lead acid-type batteries. Repair discharged batteries and add up to one year of life. New smart technology with advanced nine-stage charge program. Multiple programmable charge modes. Reverse polarity protection, short circuit protection and overcharge protection.

Item #	Voltage	Output	Price
230073	12V	2A @ 12V DC	\$43.99
230074	12/6V	4A @ 12V DC	\$62.99

4.5-oz. Midweight Forest Green Tarps

Cover, equipment, firewood, hay and machinery. Designed for maximum protection of the greenest and best & longest season-to-season tarps. Coated, 1,000-denier polyethylene material. UV treated, 9 mil thick. See also our website.

Item #	Size	Price	Item #	Size	Price
G53600	8' x 8'	\$6.99	G53627	20' x 20'	\$54.99
G53605	8' x 10'	\$11.99	G53630	20' x 30'	\$69.99
G53610	10' x 10'	\$23.99	G53632	20' x 40'	\$95.99
G53620	10' x 20'	\$37.99	G53637	30' x 50'	\$206.99
G53622	10' x 24'	\$59.99	G53640	40' x 60'	\$299.99

6-oz. Heavy-Duty Silver Tarps

Tarps are thick and resist the sun, keeping what's under with you. UV treated for maximum life. Reinforced aluminum grommets at the corners and every 24" around the edges to secure tarp. Coated, 1,200-denier polyethylene material. 11 mil. See also our website.

Item #	Size	Price	Item #	Size	Price
G53500	8' x 10'	\$11.99	G53534	12' x 40'	\$99.99
G53510	10' x 10'	\$19.99	G53535	20' x 20'	\$69.99
G53515	10' x 30'	\$29.99	G53540	20' x 30'	\$119.99
G53520	10' x 33'	\$23.99	G53541	20' x 40'	\$152.99
G53524	10' x 36'	\$38.99	G53542	20' x 50'	\$209.99
G53530	12' x 36'	\$38.99	G53543	30' x 50'	\$284.99
G53731	12' x 20'	\$39.99	G53544	40' x 60'	\$399.99
G53532	12' x 30'	\$69.99	G53545	50' x 100'	\$939.99
G53533	15' x 20'	\$58.99			

7' size over truck length for use and weight.

7-oz. Premium Reinforced Silver/Black Tarps

Longest-lasting tarps are ideal for covering just about everything from roof piles to roofs. Constructed from a tough, 1,600-denier, 13-mil thick polyethylene material and constructed in 13 mil thickness. Seams are heat sealed for waterproof protection. Rip-reinforced hem are double stitched for maximum anchoring strength. Brass grommets and aluminum T-bar on all sides. Stronger corners. Make use of the tarp. See also our website.

Item #	Size	Price	Item #	Size	Price
127655	8' x 8'	\$15.99	127661	20' x 20'	\$124.99
127656	10' x 12'	\$39.99	127662	20' x 30'	\$188.49
127657	12' x 10'	\$56.99	127663	24' x 24'	\$179.99
127658	12' x 20'	\$75.99	127664	24' x 30'	\$222.49
127659	12' x 24'	\$89.99	127665	30' x 30'	\$269.99
127660	16' x 20'	\$99.99			

8-oz. Extreme-Duty Brown Tarps

Water-resistant barrier against all weather conditions

Provide an extremely strong protection from the elements when a lighter tarp may let you down. The key is having polyethylene tapes woven into the fabric, which is then laminated on both sides to create a total acts of barrier that can handle all weather conditions. Contains heat-welded seams, approximately every 18" and rope-reinforced hem on all edges for even greater strength. Both the only sizes and dimensions are UV stabilized for long life. Ideal for covering farm machinery or keeping firewood dry. 13 mil. See also our website.

Item #	Size	Price	Item #	Size	Price
212287	4' x 20'	\$23.49	212306	15' x 40'	\$159.99
212283	5' x 8'	\$18.99	212290	16' x 20'	\$89.99
212304	6' x 30'	\$34.99	212291	16' x 30'	\$119.99
212284	8' x 10'	\$23.99	212292	20' x 20'	\$99.99
212301	10' x 30'	\$27.99	212293	20' x 30'	\$165.99
212285	10' x 12'	\$33.99	212294	20' x 40'	\$199.99
212302	10' x 30'	\$56.99	212295	24' x 30'	\$199.99
212303	12' x 16'	\$53.99	212296	25' x 40'	\$209.99
212286	12' x 20'	\$67.99	212297	30' x 20'	\$209.99
212287	12' x 25'	\$82.99	212298	30' x 30'	\$299.99
212288	12' x 30'	\$99.99	212299	30' x 50'	\$415.99
212305	12' x 40'	\$124.99	212300	40' x 60'	\$599.99
212289	15' x 15'	\$62.49			

SIZING NOTE Actual largest size may vary 3-4" shorter than the size listed due to the manufacturing process.

4.5-OZ./9 MIL

Aluminum grommets at the corners

6-OZ./11 MIL

Reinforced corners

7-OZ./12 MIL

All brass grommets

The hem is reinforced with rope.

8-OZ./16 MIL

Brass grommets every 18"

Rope-reinforced hem on all edges



GEMPLER'S 14.5-oz. Weather Tough® Tarps

Waterproof like poly, breathable like canvas

Combine the best traits of polyester and canvas construction into one high-quality "super tarp." That means whatever you're covering is protected from the rain, snow and sun while preventing mildew and damage due to moisture. Feature brass spur grommets approximately 2' apart on all sides that don't rust or tear out like standard grommets.

NOTE: Actual finished size may be 3-5% shorter than the size listed due to the tarp-making process.

Item #	Cut Size	Price
219373	10' x 12'	\$104.99
227095	10' x 12'	\$124.99
227095	10' x 12'	\$124.99
219368	4' x 4'	\$16.49
219374	10' x 20'	\$172.99
227090	4' x 4'	\$18.99
227090	4' x 4'	\$18.99
227096	10' x 20'	\$199.99
227096	10' x 20'	\$199.99
219367	3' x 6'	\$24.49
227089	3' x 6'	\$28.49
227089	3' x 6'	\$28.49
219369	4' x 8'	\$37.49
227091	4' x 8'	\$38.49
227091	4' x 8'	\$38.49
219370	6' x 8'	\$46.49
227092	6' x 8'	\$56.99
227092	6' x 8'	\$56.99
219371	8' x 10'	\$68.99
227093	8' x 10'	\$74.99
227093	8' x 10'	\$74.99
219372	8' x 12'	\$82.49
227094	8' x 12'	\$99.99
227094	8' x 12'	\$99.99

- Olive
- Drab
- Black
- Gray



NEW

GEMPLERS Leaf Burrito Reusable Yard Debris Super Bags

Reusable! Keeps single-use plastic bags out of our landfills

The Leaf Burrito is an ingenious new yard debris system that makes the arduous task of bagging leaves, hedge clippings, weeds, sticks, and grass clippings be an incredibly simple and eco-friendly experience! It starts completely flat for instant loading then burritos up with heavy duty zippers. The 5' residential burrito holds 4+ large plastic bags of leaves and the 7' commercial burrito holds 6+ bags.

Item #	Length	Price
231237	5'	\$69.00
231237	7'	\$84.00



Sling Bag™ Tarp Bag

Use this "super-tarp" for heavy-lifting or landscaping jobs where a normal poly or vinyl tarp won't handle it. Ideal for hauling soil, sod, mulch, concrete and more. Sturdy, woven resin tarp can handle loads up to 3,000 lbs. 93"W octagon-shape tarp has four straps sewn on to allow you to easily carry, drag or lift it. Just hose it off, let it dry and fold up for easy storage.

Item #	Price
160334	\$99.99



Buyer's Guide Load-Covering Systems

Heavy-duty mesh tarps, hardware and more to help protect your load

Made from 12-oz., UV-resistant, 1,000-denier polyester mesh with protective PVC coating. Tarps have brass grommets around perimeter and 2" double-stitched hems reinforced with 2" nylon webbing. Kits include the tarps as well as cast bearings, zinc-plated hardware, folding crank handle (folds up and locks into place during transport), 22' pull rope (includes clip and hooks) and extruded aluminum crossbars that telescope to fit your exact bed width.

NOTE: To select proper tarp size, tarp width should not exceed outside width of the cab shield or bulkhead. Tarp length should be 2-3' longer than the body and cab shield length. Rear anti-sail bar is not included.

Item #	Cut Size	FO	Price
151237	6'6" x 15'	■	\$269.99
151235	7' x 15'	■	\$275.99
151236	7'6" x 15'	■	\$279.99
151238	7'6" x 20'	■	\$311.99
151239	8' x 22'	■	\$324.99

■ Oversize item: additional shipping charges will apply.



Power Lockers

Secure any equipment with wheels in just seconds

Power Lockers are the only all-in-one system that meets all State and Federal laws in one box. The PL-300 fits larger stand-on mowers, most all zero turn mowers, sprayers and fertilizer units with a tire diameter of 12-16". NO modifications needed to fit L.T. Rich Z-Sprayers and other products. Will not fit Z-Spray products with front castor suspension. Because of weight limitations, two PL-300 units are required per each Z-Spray to capture both front wheels.

NOTE: This is not an anti-theft device.

Item #	Fits	Model	Price
225044	7-11" size tires up to 5-1/8"W	PL-200	\$199.99
225045	12-16" size tires up to 7-1/8"W	PL-300	\$249.99



Ratchet Load Binders

High-strength, drop-forged steel load binders allow you to secure items to your trailer that are sharp or cannot be tied down by polyester or nylon straps. Ratchet-style binders have double-action ratchet mechanism for easy tightening. **Item # 173285** for 5/16" to 3/8" Grade 40, 5/16" Grade 70, and 5/16" to 3/8" Grade 70 chain. **Item # 173286** for 1/2" Grade 40 and 3/8" Grade 70 chain. **Item # 173287** for 5/8" Grade 40 and 1/2" Grade 70 chain.

Item #	WLL	Price
173285	6,600 lb.	\$30.99
173286	9,200 lb.	\$34.99
173287	13,000 lb.	\$43.99



TITANSTRAPS® Titan Straps® Tie Downs

Outperforms traditional bungee-type products for ease in use and adjustability

Simple yet revolutionary tie-down solution with hundreds of applications. High-performance polymer is injected with a 10-year UV additive for extra longevity. Remain flexible in extreme temperatures and climates. Ideal for securing ladders, PVC pipe, rebar, lumber or for bundling hoses and organizing items in your garage. 14", 18" and 25"L straps all have a number of holes for easy adjustments and linking multiple straps for added length.

Item #	Color	Length	Price
226918	Blue	14"	\$6.89
226919	Yellow	18"	\$7.39
226920	Orange	25"	\$7.79



Secure large loads and cargo with confidence

Ratchet assembly allows for easy adjustment and has an extra-wide handle to fit gloved hands and provide more leverage. Heat-treated hooks meet all DOT (Department of Transportation), CHP (California Highway Patrol) and CVSA (Commercial Vehicle Safety Alliance) regulations.
NOTE: Do not use for lifting loads or towing vehicles.

THE TUFF-EDGE ADVANTAGE:

- Reinforced edge protects against cuts and abrasions
- Polymer-coated yarn for extra strength and greater cut resistance

Standard Webbing	Tuff-Edge™ Webbing
Constructed from a heavy-duty polyester webbing that won't stretch as much as nylon webbing. Considered a great value due to its strength and service life.	Constructed from a heavy-duty polyester webbing with special polymer-coated yarn for extra strength and greater resistance to edge cutting and edge abrasion. 30% greater resistance to edge cutting and 67% greater resistance to edge abrasion. Breaking strength 10,000 lbs.; working load limit 3,300 lbs.; 27'L x 2"W.



LiftAll® Wire U-Hook Tie Downs

Ideal for pickup truck loads, ATVs, mowers and skid steers

Secure large loads and cargo with confidence. Ratchet assembly allows for easy adjustment and has an extra-wide handle to fit gloved hands and provide more leverage. Steel hooks are heat treated for added strength. Reinforced edge protects against cuts and abrasions, while the polymer-coated yarn provides extra strength and greater cut resistance.
NOTE: Do not use for lifting loads or towing vehicles.

Item #	Shop Supplies: Size	Material	Price
L1250	2"W x 20'L	Standard Webbing	\$34.89
L1200	2"W x 27'L	Standard Webbing	\$37.99
145646	2"W x 20'L	Tuff-Edge Webbing	\$44.19
145647	2"W x 27'L	Tuff-Edge Webbing	\$50.19

LiftAll® Grade 43 High Test Chain With Grab Hook Tie Downs

Ideal for transporting machinery, pallets or other materials with rough edges

Standard Webbing is constructed from a heavy-duty polyester webbing that won't stretch as much as nylon webbing and is considered a great value due to its strength and service life. **Tuff-Edge™ Webbing** durability with special polymer-coated yarn. 30% greater resistance to edge cutting and 67% greater resistance to edge abrasion. Breaking strength 10,000 lbs.; working load limit 3,300 lbs.; 27'L x 2"W.
NOTE: Do not use for lifting loads or towing vehicles.

Item #	Material	Price
145653	Standard Webbing	\$59.99



LiftAll® Industrial-Grade Flat Hook Tie Downs

Ideal for contractors, landscapers and farmers

Secure large loads and cargo with confidence. Ratchet assembly allows for easy adjustment and has an extra-wide handle to fit gloved hands and provide more leverage. Steel hooks are heat treated for added strength. Reinforced edge protects against cuts and abrasions, while the polymer-coated yarn provides extra strength and greater cut resistance.
NOTE: Do not use for lifting loads or towing vehicles.

Item #	Shop Supplies: Size	Material	Price
L1450	2"W x 20'L	Standard Webbing	\$35.99
145644	2"W x 20'L	Tuff-Edge Webbing	\$45.49
145645	2"W x 27'L	Tuff-Edge Webbing	\$47.99



Extreme-Duty Polypropylene Towing Rope

Tows between 125,000 to 150,000 lb.

Stronger, lighter and safer than other towing options. Designed for the sole purpose of towing. Polypropylene rope only stretches 10–14% of its length—other types of rope can stretch up to 40%. This reduces dangerous recoil if the rope ever breaks. Resists diesel fuel, battery acid, oil, gasoline, hydraulic fluid and fertilizers. UV resistant. Ropes feature two extremely strong D-rings. 40'L.

NOTE: Never attach rope to a chain or to any attachment point with a lower rated strength than the rope.

Item #	Applications	Diameter	Rated Capacity	FO	Price
212618	Large Combines	4"	125,000 lb.	■	\$728.99
212619	Track Vehicles	5"	150,000 lb.	■	\$989.99

■ Oversize item: additional shipping charges will apply.



Bulk Twisted Polypropylene Rope

Twisted rope is formed by coiling three strands together in the same direction. Because of its light weight, polypropylene is the only rope that floats. It is not as strong as nylon or polyester, but is a good all-purpose rope that resists most chemicals, rot and mildew. Ideal for marking off areas at golf courses, nurseries and public events. Yellow color. Sold by the reel.

Item #	Length	Rated Capacity	Diameter	Price
226899	600'	1,130 lb.	1/4"	\$52.99
226898	600'	2,440 lb.	3/8"	\$58.99



Double-Braided Bull Rope

The toughest rope we've found! Nylon core is covered in a polyester jacket to exceed the breaking strength of double-braided polyester. Rope can be spliced.

Item #	Color	Diameter	Length	Price
124801	Blue	1/2"	150'	\$164.99
124802	Yellow	9/16"	150'	\$194.99
124803	Red	5/8"	150'	\$218.99
124804	Orange	3/4"	150'	\$242.99



Hollow-Braid Polypropylene Line

The perfect choice for marking off areas and in golf courses, nurseries, athletic fields and more. Tie knots easily. Can be hand spliced. 990-lb. breaking strength. Roll measures 1,000'L x 1/4-dia.

Item #	Price
156327	\$56.49



Endlessly Reusable



Chemical, UV & Water Resistant



Infinite Uses & Applications



Flexible & Reusable



Reusable Tie Straps

Say goodbye to single-use zip ties

Three lengths handle a wide variety of jobs around your home and workshop. So versatile that we stopped counting ways to use it after the first 2.718 bazillion uses. However you use it (or reuse it), one thing is certain: the ONE·TIE will come in handy.

Item #	Length	Qty./Pkg.	Price
230945	26"	2	\$14.99
230944	14"	10	\$15.99
230941	8"	4	\$3.99
230943	14"	2	\$3.99
230942	8"	10	\$7.99

-  Black
-  Red
-  Yellow



Premium Bungee Cords

Braided using first-quality, long-lasting rubber. A durable, multi-colored jacket gives added abrasion and sunlight resistance. Vinyl-covered hooks will not scratch and are strong enough to withstand abuse. Color may vary. Pkg. of 10.

Item #	Length	Price
G56014	13"	\$11.19
147763	18"	\$12.59
G56025	24"	\$15.99
G56037	36"	\$17.99



Bulk Cable Ties

Perfect for all of your fastening applications. These nylon zip ties feature finger grips for easy handling and allow the tie to be partially closed without engaging the pawl. One-piece design, transition rails and teeth provide a low insertion force, while maintaining a high-tensile strength. Specify color: black or natural.

Item #	Length	Qty./Pkg.	Price
G51351	5"	1000	\$18.49
G51352	7"	1000	\$27.49
G51353	11"	500	\$30.49
G51354	14"	500	\$35.49
G51350	4"	1000	\$9.99

-  Black
-  Natural



Multipurpose Ball Bungees

Will not rust. No metal parts to worry about harming yourself or your things. Pkg. of 50.

Item #	Length	Price
G53702	6"	\$15.99
G53701	8"	\$19.99

Did the world need a better bungee? Darn right!



- Black
- Military Green
- Safety Green
- Yellow
- Red
- White
- Blue
- Orange

The Better Bungee™ Cords

Safer and stronger than traditional bungees. Improved cold-weather performance, high-temp and humid-conditions performance, stretch, longevity and color stability. Larger over-molded and stronger hook ends for easier anchoring and durability. Super strong, flexible polyurethane allows for safe stretching—more than twice its original length. And since there's no rubber, bungees won't crack, break, split, become brittle or stiff. Withstand exposure to UV rays, oil, salt water, gasoline/diesel fuel and most household chemicals. High-strength plastic hooks/slots prevent fraying. **Item Nos. 228219 and 228220** feature a slot opening that allow the strap to be adjusted to your desired length and are available in black only.



Item No.	L	Price
A		
Poly Strap with Galvanized Hooks		
228211	72"	\$3.49
228212	18"	\$3.99
228213	24"	\$4.29
228214	30"	\$4.99
B		
Poly Strap with Nylon Hooks		
228215	30"	\$4.29
228216	18"	\$4.59
228217	24"	\$4.99
228218	30"	\$3.99
C		
Slotted Poly Strap with Galvanized Hooks		
228219	30"	\$4.89
D		
Slotted Poly Strap with Nylon Hooks		
228220	30"	\$4.89
E		
Poly Cord with Nylon Hooks		
228221	12"	\$3.49
228222	18"	\$3.79
228223	24"	\$4.29
F		
Poly Cord with Loop and Nylon Hook		
228224	30"	\$4.29



Stretch Wrap

Clear and purple-tint high-performance stretch wrap offers good clarity to see exactly what's on each pallet. Pkg. of 4 rolls.

Item #	Length	Color	Gauge	Type	Width	Price
215071	1,000'	Clear	70	Blown	20"	\$114.99
55706	1,000'	Clear	70	Cast	20"	\$134.99
219235	1,000'	Clear	80	Cast	30"	\$195.99
215072	1,000'	Purple	80	Blown	30"	\$203.99
219641	1,000'	Clear	80	Cast	3"	\$22.49
219642	1,000'	Clear	80	Cast	5"	\$31.49
219234	1,000'	Clear	70	Blown	10"	\$69.99



Multipurpose Duct Tape

Great for emergency repairs. Can also be used to seal gloves and boots to suits and/or take "blousing" out of large protective garments. Silver color. 2"W x 180'L roll.

Item #	Price
GW219	\$8.49



8"L Double-Loop Steel Wire Ties

These black annealed steel wire ties are easy to twist and hard to break, making them ideal for tying bags, fences, wire mesh, reinforcing bars and anywhere strength is necessary. Made of 16-ga. steel wire that's been heated and cooled to improve strength without adding brittleness. Pkg. of 100.

Item #	Price
G56868	\$7.49



12"L Double-Loop Galvanized Steel Wire Ties

These 16-ga. steel wire ties are strong and easy to use. Galvanized annealed ties are made from corrosion-resistant zinc-coated wire for long life. Use for pre-stressed concrete, marine use and any application where length of service is important. Pkg. of 100.

Item #	Price
160251	\$8.99



Wrap-It™ Storage Strap

Just place Wrap-It around item, secure the hook-and-loop closure and use the grommet to hang item. Heavy-duty ballistic nylon with commercial-grade hook-and-loop.

Item #	Size	Width	Length	Price
224919	Small	1"	9"	\$2.49
224922	Medium	1-1/2"	10-1/2"	\$2.99
224923	Large	2"	12"	\$3.49
224924	XL	2-1/2"	16"	\$4.49
224927	Jumbo	3"	24"	\$6.49



Gas-Powered Post Drivers

Save time and labor—drive posts, rods and stakes in seconds! Rhino® gas-powered post drivers are powered by rugged and dependable Honda® 4-cycle engines and are lightweight for easy handling and transporting. Rhino's CIS Vibration Dampening System makes using more comfortable.

Note: not for sale in (AL;GA).

Item #	Description	HM	Price
224975	Ranch Pro Driver	▲	\$1,699.00
224976	Fence Pro Driver	▲	\$2,069.00
224977	Multi-Pro Driver	▲	\$2,549.00
230205	Ranch Pro Service Kit		\$42.99
230206	Fence Pro Service Kit		\$42.99
230207	Multi-Pro Service Kit		\$45.99

▲ Requires special handling due to DOT regulations. Additional shipping charges will apply. Cannot be shipped by air.



Description	Ranch Pro	Fence Pro	Multi-Pro
T-Posts	X	X	X
Ground Rods	X	X	X
Form Posts	X	X	X
1 - 1.5/8" dia. Posts	X	X	X
1.3/4" - 2.1/8" dia. Posts	X	X	X
Tent Stakes	X	X	X
1-1/2" - 2-1/2" Square Posts	X	X	X
1.2" - 4" U-Channel Posts	X	X	X



Heavy-Duty Post Puller

Easily removes stubborn, bent or broken posts. With the addition of the Chain and Slip Hook Accessory (sold separately below), this jack quickly removes construction stakes, galvanized fence posts, wood posts, U-channel posts and more. Constructed of heavy-duty, 1.5" square tubing.

Item #	Description	Price
HA35	Chain and Slip Hook Accessory	\$23.99
LJ27	Heavy-Duty Post Jack	\$89.99



Handyman® Jacks

This timeless lifting jack was originally designed more than 100 years ago and is the only all-cast jack made. Handyman Jacks lift, winch, clamp, pull and push. Feature a powder-coated finish to protect against rust, zinc-plated hardware and a top winch connector clamp. Rated load capacity is 4,660 lbs. with a tested load capacity of 7,000 lbs.

Item #	Height	FO	Price
270862	48"	■	\$87.99
270864	60"	■	\$89.99

■ Oversize item: additional shipping charges will apply.



"We have felled very large elm trees using the Puller. It works better than expected. The fact the line is "unlimited" keeps one from running out of pulling power as one would using fixed length cable."
—dsusdive

3/4-Ton Unlimited-Length Rope Puller

Heavy-duty come-along features an innovative feed-through design that lets you pull an unlimited length of 1/2"-dia. rope. Unlike traditional cable, rope is safer to use, is non-conductive and will not scratch surfaces. Comes with 20' of highway approved 1/2" Dacron™ polyester rope with snap hooks or use your own rope to reach the distance you need.

Item #	Price
125983	\$96.99



Jake's Wire Tighteners™ Fencing Tool

Repair fences quickly without expensive tools or having to cut wire. To replace broken wire, simply splice in a small piece of new wire, insert a Jake's wire-tightening clip, tighten. Standard 1/4" clip accommodates up to 12-ga. barbed wire. 5/16" clip works on wire up to 9-ga. bull wire and 12-ga. high-tensile wire.

Item #	Description	Qty. / Pkg.	Price
219437	1/4" Clips	20	\$15.49
219441	Wire Tightener Handle		\$16.99
219439	5/16" Clips	15	\$21.49
219438	1/4" Clips	300	\$229.99
219440	5/16" Clips	225	\$310.99

Easy to Use



1. Insert clip



2. Turn crank



3. Hook over wire



Compact Fence Cutter

Handheld 8"L wire cutter is built like a bolt cutter. Requires 60% less effort than traditional fence cutters. Unique lever action mechanism easily cuts through metal that's up to 1/4" thick. Straight design provides excellent leverage; notched head cuts through thick materials; angled head cuts flush to the surface.

Item #	Type	Price
224838	Straight Cutter	\$59.99
224839	Notched Head Cutter	\$65.99
224840	Angled Cutter	\$69.99



Automatic Twisting Tool

Heavy-duty galvanized steel construction and a unique spring return action require little effort and eliminate tired wrists from manual twisting. To tie wires, simply insert hook of twister into both tie loops of wire, pull handle and tool automatically twists wire tightly. Knurled handle for a slip-free grip. 11.5"L.

Item #	Price
159871	\$26.49



Gate Wheel

Eliminate sagging gates

Gates will swing easily with this easy-to-install gate wheel. Includes all hardware to mount onto the gate. Adjusts to any height up to 24" for those areas where the gate is on an incline or uneven ground. Wheel is 9"H x 1.5"W. Fits standard tubing up to 2" in diameter.

Item #	Price
G52248	\$59.99



GRIPPLE Torq Tool

Handheld, lightweight and compact. Features a built-in tension gauge to ensure you are applying the right amount of tension (up to 400kg of load with minimal effort) when joining two pieces of wire fencing.

Item #	Price
224791	\$82.99



Three-Hook Wire Stretcher

Perfect for a variety of jobs, including splicing, stretching, stapling and to raise and lower wire. Features a third hook that allows you to stretch an unlimited amount of wire without having to reset the entire fencing tool. It holds the wire while the traveling hook is repositioned. Can be used for high-tensile barbed and smooth wire. 35"L.

Item #	Price
126023	\$63.99



TENAX Heavy-Duty Utility/
Snow Fence

Utility/snow fence is made of polyethylene with UV inhibitors for long outdoor life. 270-lb./ft. tensile strength. 1" x 4" elliptical pattern aperture.

NOTE: For effective snow control, snow fence should be placed a minimum of 135' upwind of the area to be protected. A 4" to 6" gap between the fence and ground should be maintained for maximum efficiency.

Item #	Length	Shop Supplies : Color	Height	FO	Price
G51919	50'	Orange	4'	■	\$35.99
G51920	50'	Black	4'	■	\$45.99
G51921	100'	Orange	4'	■	\$82.99

■ Oversize item: additional shipping charges will apply.

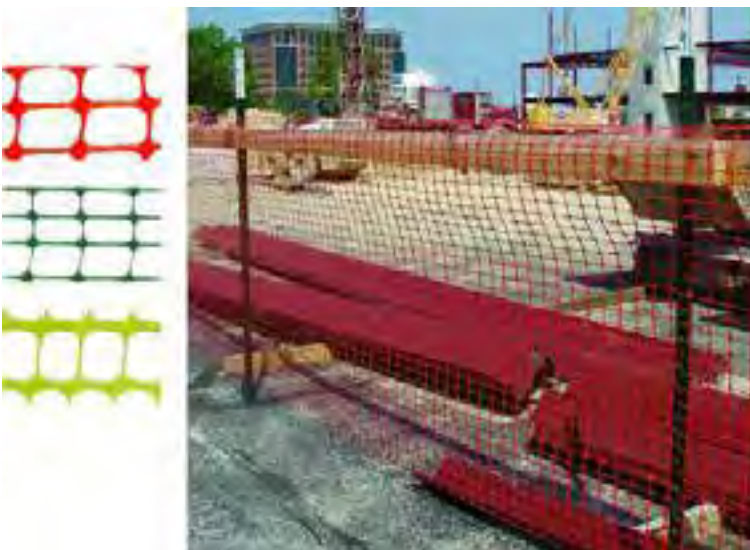

TENAX Safety Fencing

Lightweight, yet durable polypropylene fencing resists sagging and is UV-stabilized for long outdoor life. 240 lb./ft. tensile strength. 3.5" x 1.5" aperture size.

Item #	FO	Price
G51912	■	\$22.49
G51913	■	\$29.99
G51914	■	\$54.99

■ Oversize item: additional shipping charges will apply.

- Orange
- Green



TENAX Diamond Mesh Safety
Fence

The durable, rigid diamond mesh of this safety fence adds aesthetic appeal compared to ordinary fencing. Ideal for enclosing work sites, crowd control, barricades and other temporary barriers. Fence is constructed from a strong UV-stabilized polyethylene to ensure long life. 160-lb./ft. tensile strength. Specify color: orange or green.

Item #	FO	Price
145622	■	\$52.99

■ Oversize item: additional shipping charges will apply.

- Green
- Orange



Knife and Tool Sharpener

Flexible belt technology conforms to a blade as it sharpens. Ideal for serrated knives. Works great on tools like scissors, axes and hatchets, mower blades, garden shears and shovels. Includes (2) P80 coarse grit belts, (2) P220 medium grit belts and (2) 6000 fine grit belts.

Item #	Description	Price
176956	Replacement Belt Kit	\$11.49
176955	Tool and Knife Sharpener	\$84.99



LEATHERMAN Wave+ Multi-Tool

An old favorite, upgraded with replaceable wire cutters. Outside-accessible tools can be used in the closed position. **17 functions.**

Item #	Price
123530	\$99.95



LEATHERMAN Surge™

One of the largest multi-tools in the Leatherman line-up—a real powerhouse, with Leatherman's largest pliers. **21 functions.**

Item #	Price
133608	\$119.95



LEATHERMAN Super Tool® 300

The multi-tool for the working man—designed to be used when wearing gloves. **19 functions.**

Item #	Price
163990	\$89.95



Wiss Folding Pocket Knife

Titanium-coated blade is 3x stronger than steel and includes two different cutting edges and a piercing tip. Features spring assist opening with dual thumb studs and thumb hole for quick blade access. Full metal handle is slim and ergonomic for maximum comfort.

Item #	Price
230604	\$18.99



Crescent X6 Pass-Thru Socket Set

The innovative pass-thru design of this socket set allows you to reach any fastener, no matter how long it is. X6 sockets fit six different fastener types: square, 12 pt., E-Torx, Hex, partially rounded hex and spline. Each pass-thru socket replaces one standard and one deep well socket. Sockets fit SAE: 3/8", 7/16", 1/2", 9/16", 5/8", 11/16", 3/4", 13/16", 7/8" and MM: 10, 11, 12, 13, 14, 15, 17, 18, 19. Set includes a 3/8" ratchet and adapter.

Item #	Price
223434	\$39.99



Chan-A-Lock Xtra Slim Jaw Adjustable Wrenches

Longer jaws grip better, avoiding slippage or nut roundoff. Unique Slim Jaw profile is considerably thinner than most wrenches of the same size and capacity, allowing for greater access in tight spaces. Jaw capacity is greater than standard wrenches of the same size. 4"L version has 1.33" joint width, 6"L version has 1.98" joint width. Chrome Vanadium steel construction.

Item #	Length	Price
230146	4"	\$18.79
230145	6"	\$20.79



Crescent 170-pc. Crescent Tool Set

Set contains a carefully selected assortment of hand tools needed for most industrial, mechanical, and consumer applications. Tools are made of Crestoloy® alloy steel for strength and durability. These upgraded kits include a heavy-duty blow mold case with steel hinges and two latches to keep your tools organized and secure. Kit meets stringent ANSI and ASME specifications and come with a full satisfaction guarantee. Go online to see kit's specific contents.

Item #	Price
230295	\$149.99



Crescent 148-pc. Crescent Tool Set

Set contains a carefully selected assortment of hand tools needed for most industrial, mechanical, and consumer applications. Tools are made of Crestoloy® alloy steel for strength and durability. These upgraded kits include a heavy-duty blow mold case with steel hinges and two latches to keep your tools organized and secure. Kit meets stringent ANSI and ASME specifications and come with a full satisfaction guarantee. Go online to see kit's specific contents.

Item #	Price
230296	\$119.99



Heavy-Duty Pry Bar

Built to withstand even the most demanding prying tasks. Efficient blade angle and 55.5" total length provide high leverage as a crowbar and nail-and-spike puller, even in awkward positions. Forged and hardened alloy blade with a keyhole nail-pulling slot in center and V-notch in tapered edge. 3" blade width protects concrete when stripping forms. Use pry bar to help align walls during tilt-up construction, roll and align large pipe, remove shingles or flooring, and more.

Item #	FO	Price
230624	■	\$132.99

■ Oversize item: additional shipping charges will apply.



CRESCENT 18-oz. Flex Pry Bar Hammer

Handle and claw are forged of carbon steel and finished with a clear coat to prevent corrosion and rust. Extra-large striking face provides solid contact when driving nails. Magnetic nail starter makes it quick and easy to start nails with one hand. TPR grip offers comfort while prying and prevents slippage while swinging. Claw rotates to four unique positions for added leverage when prying nails and boards.

Item #	Price
230301	\$39.99



Annihilator Wrecking Bars

The most versatile utility bars ever—real time-savers for demolition and building tasks. These hybrid tools include a demolition hammer, axe, wrench, chisel, nail puller, wire stripper and a handy bottle opener. A rubber grip gives you a secure, slip-free hold.

Item #	Length	Price
230648	18"	\$45.99



NKP Industrial-Grade 36"L Bolt Cutters

Ideal for cutting fence, chain, bolts and more and have the leverage to turn 50 lbs. of hand pressure into 4,000 lbs. of cutting pressure. Heat treated to provide increased wear resistance and longer blade life. The drop-forged jaws have center-cut blades. Lockplate keeps jaws from loosening. Soft metal cutting capacity 9/16"; hard metal cutting capacity 7/16".

Item #	Price
103666	\$163.99



Bucketeer Tool Organizer

Perfect for the jobsite. Turns a 5-gal. bucket into a revolutionary tool organizer that holds more than a tool bag. Includes 30 assorted pockets to fit a wide range of tools and supplies, while leaving the bucket open for cords, drills or other bulky items. 600 poly ripstop fabric stands up to hard use.

Item #	Price
230879	\$19.99



Carhartt 14" Tool Bag

The perfect size bag to carry in the field. Main compartment is big enough for a cordless drill and with 17 pockets (10 inside, 7 outside) there is plenty of room for your hand tools. Rugged 1200-denier polyester with Rain Defender water-repellent finish that keeps gear dry in light rain. Dual comfort handles, abrasion-resistant base for longer wear and a metal inner frame for easy access. Measures 14" x 10.5" x 9". Specify color: black or brown.

Item #	Price
260105	\$49.99

- Brown
- Black



Parachute Bag

Gives you a simple, but effective way to store and carry small tools, supplies and fasteners. Perfect for the jobsite, shop or garage. Ripcord drawstring with barrel-lock closure cinches bag closed to keep stored items inside. There are 13 exterior and six interior pockets and a center carry handle that balances the load for easy transport. Bottom and pockets are made of reinforced poly ripstop. Three or four will fit inside a 5-gal. bucket.

Item #	Price
230880	\$19.99



SuperBib Apron

Functions as a tool belt and an apron. Heavy-duty duckwear canvas stands up to hard use and padded shoulder straps support weight without cutting into your shoulders. Includes 16 pockets and dual hammer loops. Quick-release belt fits waists up to 52". Measures 23"W x 23.5"H.

Item #	Price
230887	\$23.49



Tough-as-can-be, water-repellent Carhartt bags and tool belts are so heavy duty you'll be packing them today...tomorrow...forever.



Tools not included



Carhartt 14" Tool Bag

The best size bag to carry in the field, big enough for a cordless drill, with 17 pockets for your hand tools. Rugged 1200-denier polyester, with Rain Defender finish, dual comfort handles, abrasion-resistant base, metal liver frame for easy access. 14"x10.5"x9". Buckram back.

260105 \$49.99

Carhartt 20" Gear Bag

Holds everything you need for a day's work: tools, cords, batteries, chargers, you name it. Rugged 1200-denier polyester, with Rain Defender finish, abrasion-resistant base, tough top and side haul handles. 20"x10.5"x10". Brown or black.

100291 \$54.99

Build-Your-Own Tool Belt Carhartt® Legacy customizable belts & add-on components

1

CHOOSE YOUR BELT



Legacy Work Belt for lighter loads

Heavy-duty, water-repellent polyester webbing, with metal belt slat and metal gunnybells for reinforcement. Waist adjusts from 32" to 48"

107801 \$12.99



Legacy Padded Work Belt for heavier loads

High padded panel with breathable mesh backing, so even your heaviest tools fall easy and don't hang or rub. Heavy-duty, water-repellent polyester webbing. Waist adjusts from 30" to 48"

358420 \$24.99

2

ADD-ON HOLSTERS & POUCHES

Find full product descriptions at gemplers.com



Legacy Beverage Holster
275300 \$12.99



Legacy Pliers Holster
272100 \$12.99

Tools not included



Legacy Hammer Holster
358310 \$9.99



Legacy Cell Phone Holster
17601 \$12.99



Tools not included

Legacy Drill Holster
107701 \$19.99



Legacy Suspenders
261500 \$19.99



Legacy Carpenter's Pouch
107201 \$19.99

Tools not included



Legacy Framers' Pouch
107401 \$29.99

Tools not included



Legacy Electrician's Pouch
106601 \$39.99

Workwear

The first thing anyone who works outdoors needs is a good pair of gloves. Call us at 1-800-882-8473 and we'll help you get the right pair. Plus, we're your best source for Carhartt® workwear for both men and women — shop t-shirts, sweatshirts and the most easy-moving jeans and jackets around.



NEW

Columbia® Men's Utilizer™ Jacket

1771571 on pg. 434



Carhartt® Midweight Hooded Logo Sweatshirt

K288 on pg. 438



Gempler's® Cowhide Gloves with Drawstring Wrist

650L on pg. 393

GEMPLER'S® carhartt 



TOP BRANDS



Gloves	393-407
Accessories	408-412
Rainwear	413-432
Outerwear	429-436

Shirts & Sweatshirts	437-447
Pants & Shorts	448-454
Bibs & Coveralls	455-459
Base Layer	460



GEMPLER'S 100% Waterproof Insulated Pigskin Work Gloves

No more worrying about cold, wet hands

Three-layer technology blocks out water before it reaches your hands or the Heatkeep® lining insulation. Unlike other waterproof/insulated gloves, ours are constructed of pigskin.

Item #	Size	Description	Price
21938	S-XL	Knit Wrist	\$19.49
21939	S-XL	Safety Cuff	\$21.29



GEMPLER'S Cowhide Leather Gloves

These quality gloves are generously sized. A keystone leather thumb ensures the best possible dexterity. Drawstring back can be pulled snug around the wrist to keep out debris and reduce slippage.

Item #	Size	Price
650L	S-XL	\$14.99



GEMPLER'S Cowhide Fencing Gloves

Exclusive gloves are great for fencing or any other job that requires long-lasting, durable gloves. Two-ply leather palm is nearly indestructible. The entire glove is constructed of side split-leather cowhide. Reinforced thumb and forefinger.

Item #	Size	Price
G22718	M-XL	\$8.99



KINCO Women's Deerskin Leather Gloves

These women's gloves are made from the most supple and flexible deerskin available. Keystone thumb provides exceptional dexterity. Elasticized wrist for a secure fit.

Item #	Size	Price
G20190	S-L	\$20.99



KINCO Women's Goatskin Gloves

Goatskin leather is known for its soft feel. Naturally rich in skin-conditioning lanolin—an effective skin conditioner. Compared to other leathers, you'll find this to be one of the best combinations of flexibility and comfort. Keystone thumb and shirred wrist.

Item #	Size	Price
214503	M-L	\$13.99



NEW



Waterproof Insulated Gloves

All-purpose winter gloves

High-quality, insulated, rubber-coated jersey work gloves are dipped in soft, natural rubber for a liquid- and cold-proof barrier. Natural rubber provides you with great grip and excellent performance in cold and wet conditions. Wrinkle finish surface provides additional grip for extra slippery objects.

Item #	Size	Price
A511	M-2XL	\$24.99



NEW



Insulated Suede Work Gloves

Insulated gloves with cowhide palm and knuckle protection

Chop, stack or carry firewood without beating up your hands. Durable cotton duck with suede cowhide palm, palm patch and knuckle. Brushed polyester lining and C100 3M™ Thinsulate™ insulation for maximum warmth and comfort. Knit wrist blocks out debris.

Item #	Size	Price
A512	M-2XL	\$17.99



NEW



Work Flex Lined Gloves

High-dexterity gloves for workdays and weekends

Textured, breathable spandex with a synthetic palm for all-day comfort. FastDry® technology lining wicks away sweat. Reinforced finger and thumb saddle, synthetic wrist pull, side vent cuff.

Item #	Size	Price
A547L	M-2XL	\$24.99



NEW



Flexer Insulated Gloves

Breathable, fleece-lined winter gloves

These men's everyday gloves keep you warm through winter, without sacrificing grip or dexterity. Made of fleece-lined spandex that's stretchy and breathable, they come with a waterproof insert to ward off the snow. Synthetic leather adds grip and durability where you need it most. Breathable spandex with synthetic leather palm, fingers and thumb.

Item #	Size	Price
A729	M-2XL	\$31.99



NEW



Pile Fencer Gloves

Tough as nails outer, sherpa lining for comfort

Gloves are made of durable cowhide suede with a reinforced palm and thumb patch. Hands stay warm with C40 3M™ Thinsulate™ insulation along with brushed poly lining on the palm and sherpa pile lining on the back of hand. Ventilated cuff.

Item #	Size	Price
A748	M-2XL	\$24.99



NEW



Waterproof/Breathable Suede Gloves

C100 3M™ Thinsulate™ insulation for maximum warmth

Insulated for warmth and have a waterproof and windproof insert for protection against the elements. Storm Defender® waterproof/breathable technology stops water from getting in but lets sweat get out. Knit wrist keeps out debris.

Item #	Size	Price
A705	M-2XL	\$29.99



KINCO Full-Grain Buffalo Driver's Gloves

Durability and softness combined, more flexible than cowhide

Unlined gloves are made of grain buffalo leather, the strongest glove leather available. Feature a keystone thumb, leather wrist hem and shirred elastic back for a snug fit.

Item #	Size	Price
192931	M-XL	\$14.79



KINCO Insulated Buffalo Leather Driver's Gloves

Heatkeep® thermal lining to keep your hands warm on cold days

Full-grain buffalo leather is the strongest leather available in a glove, yet has a softness similar to cowhide. Feature a keystone thumb, leather wrist hem and shirred elastic back for a snug fit.

Item #	Size	Price
225937	M-XL	\$17.99



KINCO Goatskin Leather Driver's Gloves

Goatskin leather is known for its soft feel. Naturally rich in skin-conditioning lanolin—an effective skin conditioner. Compared to other leathers, you'll find this to be one of the best combinations of flexibility and comfort. Ergonomic keystone thumb and shirred elastic wrist.

Item #	Size	Price
8250	S-XL	\$15.99



KINCO Deerskin Leather Driver's Gloves

Soft and supple deerskin leather

You will appreciate the dexterity that you get due to the flexibility of the leather and the way in which these gloves are sewn. Keystone thumb improves range of movement. Only grade-A leather is used so you won't find the imperfections that are common in lesser-quality gloves. Elastic at the wrist provides a snug, comfortable fit.

Item #	Size	Price
21190	M-XL	\$21.99



KINCO Insulated Deerskin Driver's Gloves

Keep warmth in and the cold out

Soft, flexible and lined with Heatkeep® insulation, making them more comfortable than most winter gloves you'll find. Keystone thumb for improved dexterity. Elasticized wrist keeps out debris and cold air.

Item #	Size	Price
21090	M-XL	\$26.99



KINCO Axeman® Insulated Cowhide Mitts

Warmth of a mitt, feel of a glove

Durable, soft and flexible cowhide leather protects against abrasions. Thermal Heatkeep® insulation keeps your hands warm even on the coldest of days with the added comfort of an inner-glove lining. Shirred elastic back gives you a snug fit.

Item #	Size	Price
125718	L-XL	\$18.99



KINCO Insulated Pigskin Gloves

Compared to cowhide, pigskin leather stands up to twice the abrasion and wear. That's what makes these gloves super durable for tough jobs, yet soft and flexible for all-day comfort. Heatkeep® lining provides extra insulation and warmth. Choose knit wrist style that keeps cold and debris out, or elasticized wrist with safety cuff that protects your wrist.

Item #	Size	Description	Price
1927K	S-XL	Knit Wrist	\$17.99
1927S	S-XL	Safety Cuff	\$17.99
1927K	XXL	Knit Wrist	\$22.99



KINCO Unlined Pigskin Gloves

Exceptional hand protection is within your grasp! Made with grain pigskin, which is softer and more flexible than cowhide. Pigskin leather on palm, over fingertips and on knuckle strap gives your hands added protection. Safety cuff style protects wrist area. Dry soft even after getting wet.

Item #	Size	Price
1917	S-XL	\$10.89



KINCO Insulated Pigskin Gloves

Tough, flexible pigskin leather and extra-warm insulation will make these work gloves your favorite cold weather investment. Fully lined with Heatkeep® insulation that keeps hands toasty warm in the coldest conditions. Enjoy greater durability, flexibility and softness compared to cowhide gloves. Knit wrist keeps out debris and cold air.

Item #	Size	Price
22760	M-XL	\$15.99



NEW **KINCO** Economy Suede Cowhide Palm Gloves

Cotton blend canvas on back of hand and cuff provides lightweight, breathable coverage. Cowhide palm and fingers for dexterity and abrasion resistance. Cowhide knuckle strap gives you extra protection from bumps and cuts. Safety cuff protects wrist area.

Item #	Size	Price
231176	M-XL	\$4.99



NEW **KINCO** Suede Cowhide Double-Palm Gloves

Cotton blend canvas safety cuff is rubberized to provide additional protection. Extra cowhide patches on palm, thumb and index finger reinforce high-wear areas, while extra-strength Drayton thread prevents thread failure.

Item #	Size	Price
231177	L-XL	\$12.99



KINCO Pigskin Gloves with Hi-Vis Mesh

Hi-vis nylon mesh back is breathable, form-fitting and wicks away moisture while maintaining its shape. Plus, a 3M™ Scotchlite™ reflective strip keeps you visible at night. Abrasion-resistant pigskin leather is soft, yet extremely durable. Ergonomic keystone thumb lets you move freely. Elastic wrist keeps out debris.

Item #	Size	Price
160390	M-XL	\$14.99



NEW



HydroFlector™ Cowhide Driver's Gloves

Premium grain cowhide with innovative aquaHIDE water-resistant technology for protection in wet conditions. Shirred elastic wrist and ergonomic keystone thumb. Outseam index finger for a smoothseamless interior. For lightweight warmth, choose gloves lined with Heatkeep® thermal insulation.



NEW



Lined Black Deerskin Driver's Gloves

Soft, flexible premium deerskin leather, lined with Heatkeep® insulation, for a bulk-free feel that's more comfortable than most winter gloves. Keyhole thumb for improved dexterity. Elasticized wrist locks out debris and cold air.

Item #	Size	Price
231174	M-XL	\$34.99



NEW



Lined Cowhide Driver's Gloves

Durable grain cowhide gloves are lined with Heatkeep® insulation providing a bulk-free feel that is more comfortable than most winter gloves. Keyhole thumb for improved dexterity. Elasticized wrist keeps out debris and cold air.

Item #	Size	Price
231175	M-XXL	\$19.99



NEW



Cowhide Driver's Gloves

Unlined grain cowhide leather gloves are soft and supple with a shirred elastic wrist for easy on/off and to lock out debris. Keystone thumb for full range of motion. Outseam index finger provides the smooth, comfortable feel of a seamless interior.

Item #	Size	Price
231170	S-XL	\$15.99
231170	XXL	\$16.99



NEW



Pro™ Deerskin & Synthetic Hybrid Gloves

Maximum dexterity and comfort. Abrasion-resistant grain deerskin palm and fingers with a polyester/spandex back for a form-fitting feel. Neoprene pull strap lets you snug 'em up, as much as you want.

Item #	Size	Price
231181	M-XL	\$26.99



Unlined Pigskin Driver's Gloves

Porous, premium-grain pigskin offers superior breathability compared to other leathers - keeping you comfortably cool even on the warmest days. Keystone thumb gives you better comfort and longer wear. Gloves provide an excellent sense of touch and feature a self-hemmed cuff. Shirred wrist provides a snug fit around wrist to keep dirt and debris out.

Item #	Size	Price
218964	L-XL	\$4.99



Kevlar-Lined Cowhide Driver's Gloves

Provides ANSI Cut Level A2 protection

Premium-grade cowhide gloves are sewn and lined with DuPont™ Kevlar® for superior cut resistance. Ideal for a variety of applications including farming, landscaping and construction. Keystone thumb fits the natural curvature of your hand for added comfort. Shirred elastic back.

Item #	Size	Price
230018	S-2XL	\$19.99

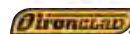

Ranchworx® Gloves

Top-of-the-line gloves handle tough, gnarly jobs in the most abrasive conditions. Constructed of Bullwhip® leather with Kevlar® and Duraclad® reinforcements to protect critical areas. Patented fingertip and palm designs give you superior dexterity, whether you're roughing it out on the ranch or working a precision task. Machine-washable leather won't harden or shrink.

Item #	Size	Price
218664	S-2XL	\$45.29



Heavy Utility™ Gloves

Combine long-wearing toughness with the tactile feel and dexterity you need. Duraclad reinforcements are 8X more durable than normal synthetic leather. Hybrid cuff fits securely and has a quick-release safety feature. Cuff puller for easy on/off. Terry cloth sweat wipe on back of thumb. Synthetic leather palm and finger sidewalls. TPR knuckle protection.

Item #	Size	Price
218904	S-2XL	\$24.99



Women's Pigskin Leather Palm Gloves

Soft fleece lining for comfort

Pigskin is a more durable leather and dries soft after getting wet. The wing thumb allows flexibility and improved dexterity. Shirred (elastic) back keeps the glove securely in place. Safety cuff provides added protection.

Item #	Size	Price
G24102	S-L	\$6.99



Women's Cowhide Driver's Gloves

Grain cowhide gloves have a shirred elastic wrist for easy on/off and to lock out debris. Ergonomic keystone thumb provides a full range of motion. Outseam index finger provides the smooth, comfortable feel of a seamless interior.

Item #	Size	Price
231172	S-L	\$15.99



GEMPLERS Cotton Knit Gripper Dot Gloves, Dozen Pair

Vinyl dots provide additional grip

For greater wear and better grip, try these gloves with vinyl gripper dots. Perfect for handling small parts, picking fruits and vegetables, gardening and chore work. Ambidextrous gloves conform to any hand size and are much cooler than leather gloves. Vinyl impregnations on both sides of glove double your wear and the life of the glove. Machine washable. Size Medium and Jumbo are currently out of stock. Shop G1777 as a replacement.

Item #	Size	Price
M59X	M-Jumbo	\$14.99



NEW

Waterproof Neoprene Gloves

These Glacier Glove Waterproof Neoprene gloves are perfect for cold, wet jobs like packing vegetables in ice or power washing machinery in cold weather

Glacier Glove Kenai™ Waterproof Gloves have a supple, neoprene outer shell (1/16") which acts as an excellent thermal barrier - making them the perfect protection for all of your cold, wet jobs. Available sizes: M (7.5-8), L (8.25-9) or XL (9.25-10).

Item #	Size	Price
K16	M-XL	\$23.99



NEW



Pro™ Lined Deerskin & Synthetic Hybrid Gloves

The grain deerskin palm and fingers you like for abrasion resistance, with a polyester/spandex back for a form-fitting feel. Gloves provide maximum dexterity and comfort. Heatkeep® thermal insulation adds warmth without bulk.

Item #	Size	Price
231184	M-XL	\$28.99



Brown Jersey Work Gloves, Dozen Pair

Perfect for light jobs, these gloves are made of 9-oz. two-way stretch jersey material that is form-fitting, breathable and protects your hands in cool comfort. Soft, 60% polyester/40% cotton blend won't stretch out of shape. Snug fitting knit wrist.

Item #	Size	Price
27507	L	\$17.99



Cotton Chore Gloves, Dozen Pair

Economical hand protection

Lightweight 8-oz. cotton work gloves for hand protection in warm weather. Knit wrist is snug fitting to keep debris out. Gloves protect against dirt and abrasions.

Item #	Price
I80C	\$16.29



GEMPLERS Latex-Coated Work Gloves

Excellent performance with an economical price

According to our field test, these are the best, most durable coated gloves available. Knit material is a soft, yet durable, blend of cotton and polyester that completely conforms to your hand. You may even forget you are wearing gloves! Thick, textured, latex-coated palm and fingers are chemical and water resistant, provide incredible grip, and are designed to fit the natural shape of your hand.

Item #	Size	Price
109868	S-XL	\$4.49



NEW

Original Kenai Gloves

Fleece-lined neoprene for warmth

Versatile, water-resistant glove designed to keep you outdoors while still giving dexterity where you need it. Crafted to withstand any adventure, these gloves are perfect for the outdoorsman. Seamless palm design won't fray. Glacier's best value gloves. 2mm neoprene with a grippy sharkskin texture and cozy fleece lining.

Item #	Size	Price
231187	M-XL	\$19.99



NEW

Perfect Curve Waterproof Gloves

Pre-curved fingers reduce fatigue

The one that started it all! Designed with premium neoprene, pre-curved fingers and a fleece lining, these gloves will help you last outdoors all day. Cinch down wrist strap when submerging hands in water above glove cuff.

Item #	Size	Price
231188	M-XL	\$49.99



NEW

Elite Tactical Gloves

Perfect for fall and spring

Lightweight gloves are made of a water-resistant material that features a form-fitting design and reinforced palm that provide a combination of comfort and durability.

Item #	Size	Price
231189	M-XL	\$29.99



NEW

Alaska Pro™ Waterproof Gloves

Unsurpassed combination of warmth and dexterity

Made of a breathable, 100% waterproof material to keep hands comfortable and dry. Genuine leather palm provides extra durability.

Item #	Size	Price
231192	M-XL	\$39.99



Ninja® Flex Latex-Coated Gloves

Crinkle-coated gloves combine the best of durability and flexibility. Breathable, 15-ga. nylon/spandex shell helps keep your hands cool. Features latex coating on fingers and palm for a secure grip. Excellent dexterity for parts counting, assembling and multiple outdoor tasks. Treated with Actifresh® to kill bacteria and promote freshness.

Item #	Size	Price
150637	S-XL	\$3.59



NEW



Ninja® Ice Hi-Vis HPT-Coated Nylon Gloves

These hi-vis gloves feature a 15-ga. lime nylon shell with a 7-ga. acrylic terry interior liner for warmth. HPT coating goes beyond the palm and fingertips to over the knuckles for added protection. Coating repels liquids, remains soft in temperatures as low as -58°F and gives you a strong wet or dry grip.

Item #	Size	Price
231199	M-XL	\$6.99



NEW



Ninja® Lite Polyurethane-Coated Gloves

Get that "second skin" feeling wearing these featherlight gloves - 30% lighter for greater tactile sensitivity. Feature an 18-ga., athletic-grade blue nylon shell with a black PU coated palm and fingertips. Latex free.

Item #	Size	Price
231194	M-XL	\$2.99



NEW



Ninja® BNF with NFT® Coating Gloves

These gloves feature a 15-ga. nylon/spandex shell that has a BNF (breathable nitrile foam) with NFT® coating on the palm and fingertips providing great dexterity, flexibility and movement. Palm and fingertips also covered with dots for excellent wet or dry grip. Ergonomic design reduces hand fatigue.

Item #	Size	Price
231197	M-XL	\$3.49



NEW



Ninja® Ice HPT-Coated Nylon Gloves

Ninja® gloves are engineered to provide the greatest assortment of dexterity, sense of touch and protection. Ice gloves feature a 15-ga. black nylon shell with a 7-ga. acrylic terry interior liner for warmth. HPT coating on palm and fingertips repels liquids, remains soft in temperatures as low as -58°F and gives you a strong wet or dry grip.

Item #	Size	Price
231198	M-XL	\$6.49



NEW



**Cut Pro™
Polyurethane-Coated
Gloves**

Worth the money from day one. Cut Pro gloves provide high dexterity and comfort with an 18-ga. Hypermax™ shell. Polyurethane coated on the palm and fingers for excellent cut protection.

Item #	Size	Price
231204	M-XL	\$4.99



**Ultratech® Kevlar®
Nitrile-Coated
Gloves**

The superior fit, comfort and protection you need to complete the task. DuPont™ Kevlar® fiber provides high tensile strength relative to its weight—up to 5X stronger than steel! Textured, nitrile-coated palm. Seamless knit gives you a comfortable fit and allows manual dexterity.

Item #	Size	Price
224308	S-XL	\$8.39



**Polyurethane-Coated
Nylon Gloves**

MCR Safety Polyurethane-Coated Gloves provide excellent dexterity for handling packages and small parts

Rugged-yet-comfortable nylon shell and polyurethane palm/finger coating provide tactile sensitivity and grip for package handling or small parts handling. Knit wrist has a color-coded hem that helps workers quickly identify the size of glove they need.

Item #	Size	Price
224313	S-2XL	\$2.29



**Memphis™ Foam
Nitrile-Coated Nylon
Gloves**

Nitrile dip over the palm, fingers and knuckle add extra protection that's great for highly abrasive jobs like construction, farming and landscaping. Nylon shell is rugged and flexible giving you excellent dexterity. Knit wrist gives you a secure fit while protecting your wrist.

Item #	Size	Price
224316	S-L	\$3.89



NEW



**Cut Pro Hypermax™
Nitrile-Coated
Gloves**

These gloves offer cut protection that is lightweight, comfortable and has excellent dexterity. 18-ga. Hypermax™ shell is coated on the palm and fingers with a thin layer of nitrile and also features a reinforced thumb crotch for added durability.

Item #	Size	Price
231256	M-XL	\$7.49



**Foam Nitrile-Coated
Nylon Gloves**

Excellent dexterity and comfort are the trademarks of these tough gloves. Seamless nylon shell and black foam nitrile-dipped palm and fingers give you a comfortable fit and excellent grip. Ideal for abrasive applications like brick handling, farming, landscaping, general maintenance and more. Knit wrist.

Item #	Size	Price
224315	S-XL	\$3.29



Abrasion-Resistant Gloves

Ideal for stone work, pruning, packing and more

Cotton polyester shell is cool and offers excellent comfort and fit. Choose between Thermal for added warmth, Traditional rubber-coated glove or Extended version when the job requires additional protection. Deeper dip on the extended version provides superior knuckle and finger protection.

Item #	Size	Description	Price
PF300	S-XL	Traditional	\$4.99
109642	M-XL	Extended	\$4.99
105128	S-XL	Thermal	\$6.99



Biodegradable Nitrile-Coated Gloves

A more-eco-friendly way to repel oils, greases and abrasions

Eco Best Technology® defends against oils and greases, then biodegrades in the landfill after you've thrown gloves out. Abrasion resistant and flexible, with a great fit and excellent dexterity. Grip is long lasting and reliable. Breathable back of hand. Lightweight, 15-ga. liner. Meets EN388, Level 4.

NOTE: EN388 abrasion-resistance rating is not guaranteed after washing.

Item #	Size	Price
225824	S-XL	\$4.99



Reinforced Latex Grip Gloves

Double-layered thumb crotch for extended wear

Outstanding abrasion resistance and a sure grip while handling rough or slippery materials. Cotton/polyester shell is cool wearing and offers excellent comfort and fit. Gloves conform snugly to the natural shape of your hands for longer use and less fatigue, making them ideal for work or any weekend project.

Item #	Size	Price
138386	M-XL	\$4.99



Atlas 317 Hi-Vis Latex-Dipped Gloves

Greater visibility in diminishing-light conditions

High-visibility glove features a bright lime-green cotton polyester blended shell and a contrasting orange latex dip. The textured latex dip, which provides outstanding grip, is perfect when working with long-handled tools, rope, landscaping stone or anything that requires added hand protection. Form-fitting shell conforms to the shape of your hand.

Item #	Size	Price
156550	M-XL	\$4.99



Atlas KV300 Cut-Resistant Gloves

Gloves combine the high tensile strength of a Kevlar® seamless liner with the resiliency of a natural rubber coating. This coating gives you outstanding puncture resistance, excellent wet or dry grip, and high flexibility. Level A3 ANSI cut-resistance.

Item #	Size	Price
156551	S-XL	\$12.99



Double-Dipped Cut-Resistant Gloves

A top choice for work requiring cut and abrasion resistance, like recycling, sheet metal work, handling thorny shrubs, stone work and more! Gloves are double-dipped when made. The first layer is natural rubber and the second is nitrile rubber, combined they provide excellent cut resistance and flexibility. Outer nitrile rubber coating resists oil and grease and has an aggressive wrinkle finish for exceptional wet and dry grip. Cotton liner. 2.5" rubberized safety cuff.

Item #	Price
3910	\$6.99



Insulated Rubber-Coated Jersey Gloves

Excellent for cold and wet outdoor jobs. Triple-layer construction of foam insulation sandwiched between a layer of cotton jersey and cotton interlock to lock out cold and seal in warmth. Chemical resistant—use when natural rubber is recommended. A 2.5" safety cuff helps to protect your wrist and keep debris out. Wrinkle-finish surface provides additional grip.

Item #	Price
96NFW	\$11.69



Liquidproof Insulated PVC-Coated Gloves

Appropriate for handling anhydrous ammonia

These gloves outperform lined leather winter work gloves down to temperatures of 10°F. PVC coating provides long-lasting durability and is 100% waterproof. Extra-long knit wrist.

Item #	Price
G23491	\$11.59



KINCO Frost Breaker® Latex-Coated Gloves

7-ga. acrylic thermal knit shell repels the cold

Crinkle latex coating on the palm and thumb provides abrasion, puncture and tear resistance, plus a great grip. Acrylic thermal knit shell wicks away moisture with seamless, form-fitting comfort. Elastic knit wrist.

Item #	Size	Price
214499	S-XL	\$6.69



KINCO Warm Grip® Latex-Coated Gloves

10-ga. acrylic thermal knit shell locks in warmth

The light insulation and latex-coated palm of this glove allow for excellent grip and abrasion resistance, even in cold conditions. Gloves conform to the natural curves of your hands, giving you the flexibility and dexterity you need to handle a variety of tools and materials. Knit wrist for a snug fit.

Item #	Size	Price
125697	S-XL	\$6.99



KINCO 18-oz. Heavyweight Chore Gloves

These work gloves are made of a heavyweight, breathable chore material with an angled wing thumb design, which is seamless between palm and thumb, that adds flexibility and comfort. Snug-fitting knit wrist keeps out debris, while holding in warmth.

Item #	Size	Price
139515	M-2XL	\$5.99



KINCO Alyeska® Unlined Ragg Wool Gloves

Keep hands warm and toasty with wool gloves that don't itch

You'll be pleasantly surprised at the warmth, comfort and fit of these wool/acrylic blend gloves. A snug fit and PVC dots make this the perfect work glove for outdoor projects. Elastic knit, seamless design for dexterity and comfort.

Item #	Size	Price
122068	M-XL	\$10.99



KINCO Women's Latex-Coated Knit Gloves

Light layer of insulation for colder conditions

Coating on palm and fingers gives superior abrasion resistance and incredible grip when handling cold tools and materials. Designed to conform to the natural curvature of your hands.

Item #	Size	Price
134134	S-L	\$6.19



KINCO Women's Latex-Coated Knit Gloves

Protects without adding bulk that can interfere with dexterity

Polyester knit glove is highly breathable and durable. The latex coating on the palm and fingers allows you to grip things securely and acts as a barrier to water, dirt and grime.

Item #	Price
21791	\$4.29



NEW

Ironclad Grip Touch Gloves

Gloves feature a silicone fused grip palm with touchscreen conductive palm and fingers. Neoprene padded knuckles, terry cloth sweat wipe and hook-and-loop closure for a secure fit.

Item #	Size	Price
193218	M-XL	\$19.99



NEW

Ironclad Impact Touch Gloves

These gloves have impact-absorbing palm pads and full back-of-hand TPR protection. Ventilated flex panel on back of glove provides breathability. Touchscreen palm and fingers. TPR hook-and-loop closure for a secure fit. Terry cloth sweat wipe.

Item #	Size	Price
193219	M-XL	\$24.99



Ironclad

I-Viz® Reflective Utility Gloves

Ideal for working in high-traffic areas or anywhere extra visibility is needed. Hi-vis accents and reflective indicators increase conspicuity. Padded synthetic-leather palms. Breathable ribbed-nylon and spandex shell provides even greater dexterity. Hybrid cuff has a hook-and-loop closure and quick-release safety feature. TPR knuckle strip provides added protection. Specify color.

Item #	Size	Price	Color
222403	S-2XL	\$23.99	Orange
			Lime



Ironclad

General Utility™ Gloves

These work gloves will soon become your go-to high-performance utility gloves! Feature synthetic leather reinforcements in critical areas to give you lasting durability and protection. Hybrid cuff with quick-release feature. Patented palm provides dexterity and durability.

Item #	Size	Price
224226	S-2XL	\$22.99



KINCO

Pro™ Waterproof Insulated Utility Gloves

Form-fitting, stretchable polyester/spandex fabric back provides a snug fit, while durable MiraX2™ suede synthetic leather provides flexible, long-lasting palm protection. EVA anti-vibration and shock-absorbing palm pads help reduce blisters and hand fatigue. aquaNOT!® waterproof insert lines the entire interior keeping hands dry. Heatkeep® thermal insulation locks in warmth.

Item #	Size	Price
163267	S-2XL	\$29.99



womenswork
along with women
building a gentler world

Digger Gloves

Best-fitting chore glove for women

Made of machine washable material with colorful spandex on the back. Ideal for chores requiring dexterity and comfort. Terry brow wipe on thumb helps wipe away sweat. Reinforced fingertips add durability and prevent tears and cuts.

Item #	Size	Price	Color
230239	S-L	\$15.99	Purple
230238	S-L	\$15.99	Green



Disposable Cotton Glove Liners, Dozen Pair

Glove liners are worn inside rubber/chemical gloves to absorb perspiration. 100% cotton lisle for strength and durability. Unhemmed and reversible.

Item #	Gender	Size	Price
229930	Female	M-L	\$6.99



Guard-Tex® Cut-Resistant Safety Tape

Form-fitting hand protection that's great for handling small items

Help protect your hands and fingers against sharp edges, hot surfaces and abrasive materials without having to wear bulky gloves. This self-adhering safety tape molds to fit any size finger or hand and doesn't leave a gummy residue. Open-mesh design allows skin to breathe. 1"W x 90'L roll.

Item #	Price
GT30	\$4.99



Hand Cream

This white, odorless hand cream is not greasy and absorbs quickly to give you prompt relief from the most seriously dry, chapped hands. Its concentrated formula repairs skin dried out from water and chemical exposure. Includes 15 natural B-complex vitamins to promote healthy tissue growth. 4.5-oz. tube that's perfect for bags, cars or near the kitchen sink.

Item #	Price
1776	\$7.49



O'Keeffe's Working Hands Cream

Treats dry, cracked, split hands and feet. It's glycerin-based to penetrate deep into your skin, unlike oil-based products that form a greasy barrier on the skin's surface. Odorless. 3.4-oz. tub.

Item #	Price
109875	\$7.49



NEW



Bloody Knuckles Hand Repair Balm

Dry, cracked hands are like living testaments to a man's hard work and ingenuity. Made with lanolin, it provides much-needed moisture without leaving the hands feeling sticky or greasy (like that stuff in the green jar). Unscented.

Item #	Price
193144	\$9.99



Tiger Breakaway Glove Clip

Clip locks gloves and PPE to your tool belt, vehicle or work station. Great for securing earmuffs, knee/elbow pads and small respirators. Breakaway clip separates at 15 lbs. of force for added safety around machinery. Durable thermoplastic construction. Locking cam lock-loaded jaws. Tiger clips open to 3/4" and hold up to 5 lbs.

Item #	Price	
225802	\$10.99	Lime
		Black



PERSONALIZE

carhartt **A18 Watch Cap**

Protects your head and ears from the cold and wind

Thick acrylic yarn makes this timeless watch hat a warm option for the colder months. Keeps you focused on the job at hand, instead of the cold. Soft acrylic won't itch like wool and the stretchy rib knit creates a stay-put fit. Fold-up cuff with Carhartt patch. Specify color.

Item #	Price
CH55	\$14.99

- Red Navy
- Heather Gray
- Brown
- Lime
- Black
- Dark Brown
- Charcoal
- Orange
- Navy



PERSONALIZE

carhartt **2-in-1 Fleece Hat with Face Mask**

Keeps your head and face warm in all kinds of weather

100% fleece polyester outer shell with a 90% polyester/10% spandex pull-down face mask. With the mask tucked away, the bomber-style design keeps your head and ears warm. Mask pulls down to provide additional face protection. A202 and 100795. Specify color.

Item #	Price
139164	\$14.99
139164	\$19.99

- Black
- Lime
- Orange
- Charcoal
- Dark Brown
- Heather



PERSONALIZE

carhartt **A205 Knit Beanie Hat**

Will last longer than cheap look-alikes

Hat can be worn comfortably under a hard hat, hoodie or ear protection to keep your head warm on cold days. Soft acrylic rib knit has just the right amount of stretch and doesn't make your forehead itchy. Specify color.

Item #	Price
214137	\$14.99

- Black
- Brown
- Navy
- Gray



Outback-Style Sun Hat

Lightweight and comfortable for scorching summer days

A 3"W brim keeps the sun off your head, ears and neck. Open-weave mesh crown allows air to circulate freely. Durable cotton twill construction. Adjustable chin strap keeps hat securely in place on windy days. Specify color.

Item #	Size	Price	
G23016	S-3XL	\$32.99	Green Khaki



PERSONALIZE



Blitzing 3.0 Cap

Don't be a hothead - wicking HeatGear® sweatband keeps you drier, cooler

Under Armour's most popular cap, in stretchy and breathable polyester, with wicking HeatGear sweatband keeps you drier and cooler. Low-profile fit. Head size: S/M (20-7/8" to 21-1/2"), M/L (22" to 23"), L/XL (23" to 24-1/4"), XL/XXL (24-1/4" to 25-1/2").

Item #	Size	Price	
231020	S/M-XL/2XL	\$25.00	Black Graphite Midnight



NEW



Men's Truckstop Beanie 20

The ribbed 100% acrylic knit is super comfortable - great for kicking back, but great for work too. It wicks away sweat to keep your hardworking head dry. One size fits most. Specify color.

Item #	Price	
231127	\$22.00	Academy / Black Trial Green Black Steel



NEW

Columbia Bora Bora™ II Booney Hat

Stay safe and comfy three ways

The workhorse of Booney hats, the Columbia Bora Bora II combines UPF 50 protection, an ultra-sweat-wicking band, and a mesh vent panel. Adjustable drawcord and toggle at back. Fits adult hat sizes from 6-5/8 to 7-3/4 (or adult head sizes 21-1/4" to 24-1/2").

Item #	Price	
231091	\$22.50	Grill Fossil



BRONER Solarweave® Breezer Hat

Specially treated for superior sun protection

Outback-style design features a mesh crown to help keep your head cool on the hottest days. Brim and crown are made from treated Solarweave® material that reduces 99% of the sun's harmful UVB rays. Features reinforced stitching on the 3" brim and a leather chinstrap with adjustable toggle. Specify color.

Item #	Size	Price	
224184	M-XL	\$24.99	<div style="display: flex; justify-content: space-between;"> <div style="width: 20px; height: 10px; background-color: #c08040; border: 1px solid black;"></div> Khaki</div> <div style="width: 20px; height: 10px; background-color: #806040; border: 1px solid black;"></div> Olive



BRONER Lindu Straw Ultimate Shade Hat

Loose woven straw for ventilation

Huge 5" brim really throws off shade, giving you protection from the sun. Features a leatherette band, adjustable chin cord for a secure fit and an inside cloth sweatband to help prevent sweat from dripping into your eyes.

Item #	Price
218794	\$10.99



Unisex Sun Cap with Neck Guard

Coolmax® lining wicks away moisture and keeps you cool

Stay out all day if you want - we've got you covered! 4-5/8" front brim keeps sun off your face, while the extended back shade protects your neck. Adjustable toggle customizes your fit. Specify color.

Item #	Price	
224307	\$18.99	<div style="display: flex; justify-content: space-between;"> <div style="width: 20px; height: 10px; background-color: #c08040; border: 1px solid black;"></div> Fossil</div> <div style="width: 20px; height: 10px; background-color: #806040; border: 1px solid black;"></div> Khaki



Pith Helmet

Keeps its shape in the rain

Keep the sun's burning rays off your head and neck. Lacquered so that it holds its shape in wet conditions. Vinyl bill cord can be used as a chin strap. Vinyl headband adjusts to fit most head sizes and includes a terry cloth sweatband on the forehead. Weighs just 5.5 oz.

Item #	Price
182057	\$24.99



Signature Webbing Belt

Adjust or cut for a perfect fit

Made of durable heavy-duty webbing in a signature Carhartt graphic print. The plastic buckle pulls tight and holds the belt in place. Leather tip. Size XL only (up to 49" waist). Cut to fit. Specify color.

Item #	Price
CH2260	\$29.99



Clip-On Suspenders

Suspender clips stay locked in place for solid performance

Reliable suspenders hold tight and keep your pants in place. 2"W elastic straps flex and adjust for a custom fit. Heavy-duty metal clips. One size fits most. A109.

Item #	Price	Color
G20109	\$21.99	Black
		Khaki
		Navy
		Red



Detroit Leather Work Belt

Triple-stitched belt measures 1-3/8"W and is constructed of full-grain crazy horse leather, with triple-row contrast stitching. Snap fasteners on antique-nickel-finish buckle allow for easy buckle changes. Heat-stamped Carhartt logo on belt loop. Specify color and size.

Item #	Size	Price	Color
167547	34"-46"	\$29.99	Black
167547	48"-54"	\$32.99	Brown



Reversible Belt

Made of full-grain, oil-finished 1.5"W leather. Black/brown reversible. CH-22503.

Item #	Price
228010	\$34.99



Hamilton Belt

Top-grain, 1.5"W leather with snap fasteners that allow quick buckle changes. CH-22504. Specify color.

Item #	Price	Color
228011	\$26.99	Brown
		Black



Leather Work Belt

Constructed of full-grain, 1.5"W waxed bridle leather with saddle stitching. Specify color.

Item #	Size	Price	Color
167546	34"-46"	\$26.99	Black
167546	48"-54"	\$29.99	Brown



PERSONALIZE

Ansell Midweight PVC Apron

Get protection from moderate-toxicity pesticides without restricting movement

Apron is a low-cost choice offering excellent chemical protection and tear resistance. Constructed of 18-mil vinyl that's heavy enough so the wind won't blow it around yet light enough for ease of movement. Extremely durable grommets are electronically heat sealed. Includes extra-long nylon string ties. 44"L x 33"W.

Item #	Price
PVC45G	\$7.99



Ansell Lightweight, Neoprene Apron

Create a protective barrier that saves your clothes from damage when working with acids, oils, chemicals and more

This yellow Neoprene Apron is an excellent barrier to acids, oils, greases, chemicals and more. Lightweight apron is latex free. 45" x 35". Weights 1 lb. One size fits most.

Item #	Price
6181	\$18.49



Ansell Hycar® Nitrile Apron

Heavy-duty protection that saves your clothes and skin from grease, animal fats and certain chemicals

The tough, durable Hycar nitrile blend of this heavy-duty apron make it great for everyday wear during food processing, chemical processing, industrial maintenance or meat packing applications.

Item #	Price
219187	\$17.99



PERSONALIZE

KAREWEAR Denim Breakaway Shop Apron

This apron is designed for maximum safety—it won't pull you into dangerous machinery, even if it gets entangled. Ergonomic straps crisscross in back, evenly distributing the weight across your shoulders. Thick 10-oz. blue denim features two lower patch pockets and one chest pocket with pencil slots. Measures 24"W x 30"L.

Item #	Price
122866	\$25.99



PERSONALIZE

GEMPLER'S Cotton Duck Aprons

Protect work uniforms and project a professional appearance

Breathable cotton duck is abrasion and stain resistant for long wear. Heavy-duty stitching plus reinforced corners and stress points. Full apron measures 26"L x 21.5"W with adjustable neck buckle, plus two patch pockets and a narrow pocket for smaller items. Half apron measures 10.25"L x 22.25"W and has three pockets. 28"L waist ties on both. Specify color.

NOTE: For information on Heat Press options, visit our . To order this item Heat Press, please call 1-800-382-8473.

Item #	Description	Price
24353	Half Apron	\$10.99
24352	Full Apron	\$16.99

- Black
- Forest Green
- Red
- Navy
- Brown



Premium features — under \$45
A difference you can see and feel

Gempler's PVC: Lightweight and flexible. Plus it won't stick to your skin!

Typical PVC: Heavy, inflexible material that sticks to your skin when you sweat





PERSONALIZE

GEMPLERS Economical PVC Rainsuits

Premium quality, affordable price

Durable .20mm PVC-on-nylon material is reinforced with rivets in high-wear areas. Zip-front jacket has a snap-closure 2" storm flap. Hook-and-loop closures at the wrist. Oversized, attached hood has an adjustable tab on the back so you can wear it with or without a hard hat. Underarm and back vents. Bib overalls have a snap fly plus industrial-grade suspenders and clasps, while the pants have an elastic waist and drawstring with a stay-tight clasp. Leg openings on bibs/pants have 12"L zipper closures to open twice as wide as other suits on the market. 30.5"L. NOTE: Yellow and blue rainsuits are available only with jacket and bibs.

Item #	Description	Size	Price	
167460	Green Jacket with Pants	XS-5XL	\$44.99	 Green
167461	Green Jacket with Bibs	XS-5XL	\$44.99	 Yellow
167462	Yellow Jacket with Bibs	XS-5XL	\$44.99	 Blue
224317	Blue Jacket with Bibs	XS-5XL	\$44.99	

Need more info? Visit gemplers.com or call 800-382-8473 for product details.



PERSONALIZE

GEMPLER'S Stretch-Knit PU-Coated Rainsuit

Unique fibers stretch in all directions

Lightweight polyester liner with outer polyurethane coating is lighter and more comfortable than stretch-nylon styles. Strong outer PU coating stands up to scrapes, snags and abrasions better than traditional PVC. Sized for plenty of room. Full-zip front with storm flap. Vented cape back. Soft neoprene inner cuff prevents rain from soaking your arms or shirt. Pants have elastic waist with drawcord. Large leg openings allow easy on/off. Hook-and-loop ankle closure adjusts for a snug fit. Right rear pass-through pocket with flap allows access to your jeans. 100% breathable.

Item #	Size	Price
167463	S-2XL	\$82.99
167463	3XL	\$86.99

PERSONALIZE
GEMPLER'S Breathable Nylon Rainwear
High-stress areas reinforced with bar-tacks

Jacket has a two-way heavy-duty zipper front with hook-and-loop closure storm flap. Two outside covered slant pockets and an inside chest pocket. All three pockets have a zipper closure. Three-piece hood with drawstring. Inside locker loop for hanging jacket. Pants have an elastic waist with internal drawcord. Extra-long leg zippers at the bottom make putting on or taking off pants easier. Extra-deep side pockets are set on the side seams to help prevent rain from getting in. Zippered back pocket with storm flap. Both jacket and pants are fully lined.

Item #	Size	Description	Price
167437	M-3XL	Pants	\$54.99
167436	M-3XL	Jacket	\$59.99

Need more info? Visit gemplers.com or call 800-382-8473 for product details.



PERSONALIZE

GEMPLERS Breathable Ripstop Nylon Rainwear

Best packable, ripstop rain protection for the money

Ultra-durable ripstop nylon is waterproof and breathable. PU coating with taped seams for watertight protection. Both the jacket and pants are packable. Jacket features two slash-style hand warmer pockets. Left side has a zippered chest pocket and a drawcord at the hem. Attached hood also has drawcord. Adjustable cuff snaps on pants let you customize a short inseam or add a snug fit around boots. Feature elastic waist with drawcord and a rear zipper security pocket. Specify color.

Item #	Size	Description	Price	Color
214443	S-2XL Reg.	Pants	\$29.99	Green
214443	3XL-4XL Reg., LT-3XLT Tall	Pants	\$32.99	Gray
214442	S-2XL Reg.	Jacket	\$54.99	Red
214442	3XL-4XL Reg., LT-3XLT Tall	Jacket	\$59.99	Black



PERSONALIZE

TINGLEY Icon™ Hi-Vis Breathable Rainwear

Excellent freedom of movement

300-denier polyester canvas with a polyurethane coating for 100% waterproof protection. 2"W silver reflective tape provides 360° visibility in low-light conditions. **Class 3 Jacket** – D-ring access for fall protection, a storm fly front, elastic cuffs, a full-vented cape back with mesh/taffeta lining for better air circulation and a hood that rolls into the collar. Meets ANSI Class 3. **Class E Bibs** – Sturdy adjustable suspenders and quick-release buckles. Take-up snaps for an adjustable fit. Hook-and-loop straps on leg cuffs. Meets ANSI Class E; Class 3 when worn with jacket.

NOTE: For information on Heat Press options visit our . To order this item heat press please call 1-800-382-8473.

Item #	Size	Description	Price	Color
150	S-L	Lime	\$64.99	Lime
746	5X	Bibs		Orange
214	M-L	Orange Bibs	\$64.99	Orange
257	5X	L Jacket		
150	S-L	Lime Jacket	\$84.99	Lime
761	5X	L Jacket		
214	M-L	Orange Bibs	\$84.99	Orange
256	5X	L Jacket		



PERSONALIZE

TINGLEY Icon LTE™ Hi-Vis Rainwear

This rainwear keeps you comfortable, dry and visible in the darkest conditions. Waterproof/breathable polyurethane on 75-denier ripstop polyester resists tears, adds durability and allows for flexibility. 2"W silver reflective tape reflects light for 360° nighttime visibility. Dark-colored bottom helps hide dirt. **Jacket** has a drawcord-adjustable waist and D-ring access for a fall-protection harness. Zipper front with storm flap. Stitched and taped seams seal out wind and cold, adjustable hood tucks neatly into the collar. Hand warmer pockets, easy-access front cargo pockets and a front radio pocket with a clear ID holder. Meets ANSI/ISEA 107 Type R Class 3. **Pants** have an elastic waist with adjustable drawcord and take-up straps on ankle cuffs. Lower leg zippers allow easy on/off. Snap fly. Meets ANSI/ISEA 107 Class E.

Item #	Size	Description	Price
227959	S-XL	Pants	\$42.99
227958	2XL-5XL	Jacket	\$84.99



PERSONALIZE

TINGLEY Vision™ Breathable Hi-Vis Rainwear

Fluorescent yellow-green helps you stay visible, while 2"W silver reflective tape wraps around and reflects light for 360° nighttime conspicuity. Waterproof/breathable fabric keeps you comfortable in all weather and seasons. Stitched and taped-seams. Meet ANSI/ISEA 107. **Class 3 Jacket** – Storm fly front and roll-a-way hood. Full-cut shoulder. Hook-and-loop take-up straps on sleeves. Easy-access cargo pockets with hook-and-loop closure. **Class E Pants** – Elastic waist, adjustable drawcord and hook-and-loop take-up straps on the ankle cuffs allow a proper fit. Side openings on pants have a flap closure. Mildew resistant. Meet Class 3 when paired with jacket.

Item #	Size	Description	Price
150749	S-5XL	Pants	\$32.99
150747	S-5XL	Jacket	\$59.99



PERSONALIZE

TINGLEY Comfort-Brite™ Hi-Vis PVC Rainwear

Constructed of 0.35mm-thick, PVC-coated polyester for great chemical and flame resistance. Meet ANSI/ISEA 107-2010. **Class 3 Jacket** – Zipper front, hook-and-loop take-up straps, vented back with fall-protection access. **Class E Bibs** – Hook-and-loop take-up straps and heavy-duty suspenders with quick-release buckles. Meets Class 3 when combined with jacket or raincoat. **Class 3 Knee-Length Raincoat** – 48”L zipper/storm front that seals out wind, rain and contaminants.

Item #	Size	Description	Price
92640M	M	Bibs	\$29.99
92640XXL	2XL	Bibs	\$29.99
92640L	L	Bibs	\$29.99
92640S	S	Bibs	\$29.99
92640XL	XL	Bibs	\$29.99
92639	M-3XL	Jacket	\$54.99
125420	S-3XL	Raincoat	\$62.99



PERSONALIZE

TINGLEY PVC Rainsuit

Takes on jobs that chew up inferior rainwear

Made by laminating waterproof, chemical-resistant 0.35mm PVC onto a durable, puncture-resistant polyester base. Jacket has a storm flap front, attached hood, covered patch pockets and adjustable cuffs. Bib overalls have snap fly, adjustable suspenders and snap-adjustable leg cuffs. All hardware is non-conductive and noncorrosive. Welded seams have reduced bulk compared to stitched seams.

Item #	Size	Price
160286	S-3XL	\$24.99



NEW

TINGLEY Storm-Champ® Rainsuit

The ideal multipurpose rainsuit
Designed for 100% waterproof protection, this rainsuit is generously cut for ease of movement and comfort. Made of 20mm PVC-on-nylon. Features electronically welded seams, attached hood, easy-access cargo pockets, vented cape back and heavy-duty zipper--great for work or play. Two-piece suit includes hooded jacket and pants. Specify color.

Item #	Size	Price	Color
566218	S-XXL	\$41.99	Green
			Blue





PERSONALIZE

StormHide™ Down Pour Stretch Nylon Rainwear

Stays supple in cool temperatures

Nylon-coated with polyurethane to deliver outstanding durability without restricting your movement. 100% waterproof and lighter weight than conventional PVC rainwear. **Jacket** – Full front placket with snaps. Back vent and underarm grommets provide breathability. Cuffs feature an elastic inner cuffs and an adjustable outer cuff. Two large cargo pockets with hook-and-loop closures. Attached, stowable hood. **Pants** – Wide elastic waist. Adjustable snap cuffs are designed to accommodate shorter inseams. **Bibs** – Wide, easy-to-adjust shoulder straps with quick-connect buckles. Left-side adjustable hook-and-loop panel. Inside zippered security pocket. Leg zips with adjustable cuffs. Specify color.

Item #	Size	Description	Price	
163283	M-XL	Pants	\$29.99	 Loden
163283	2XL-4XL	Pants	\$32.99	 Navy
163284	M-XL	Bibs	\$34.99	
163282	M-XL	Jacket	\$39.99	
163284	2XL-4XL	Bibs	\$39.99	
163282	2XL-4XL	Jacket	\$42.99	



PERSONALIZE

TINGLEY StormFlex® Polyester Rainwear

Lightweight .40mm polyurethane on stretch knit polyester is cut to give you excellent freedom of movement and comfort. 100% waterproof. **Jacket** – Convenient roll-a-way hood-in-collar design stores the hood on nice days. Tapered hemline has an adjustable elastic drawcord for a customized fit. Front zipper closure with inner storm flap, plus hook-and-loop take-up straps at the sleeves help keep out rain. **Pants** – Comfortable, elasticized waist has an adjustable drawcord to give you the right fit. Convenient pass-through openings give you access to your trouser pockets. Hook-and-loop take-up straps at ankle cuffs.

Item #	Size	Description	Price
224201	S-2XL	Pants	\$29.99
224200	S-2XL	Jacket	\$44.99



PERSONALIZE

Hi-Vis Black-Bottom Rainsuit

This rainsuit protects you against wet, sloppy conditions while keeping you visible on the job. Reflexite® prismatic reflective tape gives you 360° visibility. Black bottom on jacket and pants helps to hide dirt. **Jacket** is constructed of 150-denier polyester with a polyurethane coating and sealed seams to repel water. Features full-length zipper front with snap-close storm flap, adjustable double-snap cuffs, cinch bottom and vented cape back. Chest cell phone pocket and two snap-close patch pockets keep your phone and other belongings secure and at hand. Jacket collar stores the hood to keep it out of your way when conditions are dry. ANSI Class 3 compliant. **Pants** have adjustable double-snap cuffs, pocket access slits and an elastic waistband for a better fit. ANSI Class E compliant. Specify color.

Item #	Price	
163263	\$82.49	 Lime/Black
		 Orange/Black





PERSONALIZE

carhartt Shoreline Waterproof Breathable Rainwear

Carhartt staked its reputation on building long-lasting gear that stands up to the toughest jobs. Constructed with a nylon oxford shell with durable Storm Defender™ water-repellent finish for long-lasting dryness and comfort. **Jacket** keeps you covered against the toughest weather with a fully taped design that's waterproof, breathable and made to last. Features a heavy-duty front zipper, removable three-piece hood and a handy left chest pocket with a waterproof zipper. It has stretchy inner cuffs which you can pull over your hands for extra coverage, plus a cut that layers well over sweatshirts and hoodies. Carhartt J162. Specify color. **Rain bibs** features fully taped waterproof seams, mesh lining and nylon taffeta lining from the knee down. Chap-style double-front construction means these bibs will really last. Ankle-to-waist two-way leg zippers have storm flaps. Reinforced nylon kick panels and snap-adjustable leg openings. Durable triple-stitched main seams. Zipper fly. Carhartt 100735. Regular sizes have a 32" inseam; Tall sizes have a 34" inseam.

Item #	Size	Description	Price	Color
145944	S-2XL Reg.	Jacket	\$129.99	Black
218971	S-2XL Reg.	Bibs	\$139.99	Olive
145944	LT-3XLT Tall	Jacket	\$144.99	Black
218971	3XL Reg., LT-2XLT Tall	Bibs	\$154.99	Olive



carhartt Rainstorm Coat and Bib Overalls

Whether you're hosing down the barn or digging an irrigation ditch, this rainwear keeps you working through it all. **Jacket** is constructed of tough midweight polyester with a waterproof poly/vinyl coating that locks out water. Adjustable drawcord hood, double storm flaps and internal rib-knit cuffs add to the protection. Two snap-close front pockets. **Bibs** are made of the same rugged, waterproof material as the coat, to take you through the toughest jobs and fiercest storms. Adjustable suspenders and snap-adjust waist let you personalize the fit for comfort in action. Zippers down each leg making it easier to get your boots on and off. Roomy zip-close bib pocket (good place to stash your phone). Specify color.

Item #	Size	Description	Price	Color
103505BLK	S-2XL Reg.	Bibs	\$79.99	Black
103508BLK	3XL-4XL Reg., LT-3XLT Tall	Coat	\$89.99	Black
103505YEL	3XL-4XL Reg., LT-3XLT Tall	Bibs	\$89.99	Yellow
103508YEL	3XL-4XL Reg., LT-3XLT Tall	Coat	\$89.99	Yellow

carhartt Dry Harbor Coat and Cargo Pants

Waterproof yet breathable is the key here: Storm Defender technology locks out water, yet lets sweat escape so you stay dry on the job. **Coat** is made of a lightweight nylon for easy-moving comfort. Features adjustable visored hood, front zipper with storm flaps, adjustable cuffs and hem, three outside pockets and drop-in inside pockets. **Cargo pants** are the same waterproof/breathable nylon as the coat, to keep you dry and comfortable even in a downpour. Large cargo pockets keep your tools close at hand, while the double layer knees have openings for knee pads. Drawcord elastic waist lets you bend, squat and stretch with ease. Specify color for coat.

Item #	Size	Description	Price	Color
103510TAR	S-2XL Reg.	Coat	\$79.99	Tarmac
103507BLK	S-2XL Reg.	Pants	\$79.99	Black
103510TAR	3XL Reg., LT-2XLT Tall	Coat	\$89.99	Navy
103507BLK	3XL Reg., LT-2XLT Tall	Pants	\$89.99	Orange



PERSONALIZE



Impertech™ Deluxe Stretch Polyurethane Rainwear

200% "stretch factor" is excellent for outdoor work

Lightweight and extremely durable, with a generous cut and stretchability. MicroWeld™ seams are stronger than the fabric itself and are great for preventing blowouts. **Jacket** – Zippered front with a storm flap, vented back and stowable hood. Waterproof pockets and adjustable cuffs. **Pants** – Elastic waistband with drawcord, 13" zippers on legs with snaps, and a double layer of Impertech™ on seat and knees. Take-up snaps at hem. **Bibs** – Higher cut in front and lower cut in back. Internal front pocket with hook-and-loop closure. Heavy-duty elastic suspender with click-type connectors. Snap take-up adjustment at waist. Zip from cuff to knee. Double layer of Impertech on seat and knees. Specify color.

Item #	Size	Description	Price	
160285	S-2XL	Pants	\$59.99	Black
160285	3XL-4XL	Pants	\$69.99	Dark Olive
160284	2XL	Jacket	\$71.97	Navy
160284	S-2XL	Jacket	\$74.99	
222306	S-2XL	Bibs	\$74.99	
160284	3XL-4XL	Jacket	\$84.99	
222306	3XL-4XL	Bibs	\$84.99	



PERSONALIZE



Impertech™ Stretch Polyester Guide Coat

Breathable protection from the rain

Knit polyester with stretch polyurethane coating flexes with you. MicroWeld™ seams prevent leaks, and the back cape is ventilated for greater dryness. Hood tucks into collar when not in use. Side zippers allow access to inner garments, and hook-and-loop cuffs adjust for a custom fit. Coat extends to the knees to keep your upper legs dry. Features two waterproof pockets and two hand-warmer pockets. 0.24mm stretch polyester backing with stretch polyurethane coating. Size Large back length is 42".

Jacket is more brown than green.

Item #	Size	Price
214521	S-2XL	\$89.99
214521	3XL-4XL	\$99.99



PERSONALIZE



Mandal PVC Rainwear

Unsurpassed seam strength helps eliminate tearouts

MicroWeld™ seams are stronger than the original fabric. 0.35mm PVC is coated on each side of a polyester base fabric for flexibility and durability. Resists spray/pesticides, as well as acetic acid, benzyl alcohol, hydrochloric acid and phosphoric acid. **Jacket** – Generously cut. Snap front closures with overflap and added internal placket. Collar snaps closed up to the chin. Two front-entry pockets with storm flaps. Attached three-piece hood, plus elastic drawcords with cord locks. Take-up cuff snaps. “Helly Hansen” print on left sleeve; “HH” logo on bottom-right front. **Bibs** – Extra front and back length. Inner chest pocket with zipper. Narrow cut. Adjustable elastic suspenders. “Helly Hansen” print at bottom of left leg. **Pants** – Drawcord waist adjustment and take-up snaps at the hem. Wide leg openings. 33” inseam. Specify color for jacket and bibs.

Item #	Size	Description	Price	
222248	4XL	Pants	\$28.37	Army Green
222248	S-2XL	Pants	\$32.99	Navy
222248	3XL-4XL	Pants	\$39.99	Orange
222246	S-4XL	Jacket	\$40.97	Yellow
222247	XS-2XL	Bibs	\$42.99	
222246	XS-2XL	Jacket	\$44.99	
222246	3XL-6XL	Jacket	\$49.99	
222247	3XL-6XL	Bibs	\$49.99	



Waterproof/Breathable Waterloo Rainwear

Keeps you bone dry even in a downpour

Revolutionary Helly Tech 100% polyester locks out water, but lets sweat vapors escape to keep you dry. **Jacket** - Adjustable hood, YKK zip front with storm flap, adjustable cuffs, hand-warmer pockets, drop tail and back vent for extra breathability. **Pants** - Elastic waist, Velcro® adjustment at leg bottoms and polyester lining for comfort. Specify color for jacket.

Item #	Size	Description	Price	
70427	S-2XL	Pants	\$50.00	Black
70127	3XL-4XL	Jacket	\$98.00	Racer Blue



Ultra-Lite Fabric

Outer Layer: DriPore Gen 2 film exposed directly to the elements, making this fabric the lightest of all Frogg Toggs materials. Soft, supple and extremely lightweight.

Inner Layer: Lightweight and performance matched blend of exclusive nonwoven fabrics designed to promote air flow and breathability while offering a smooth, soft touch when worn.

frogg toggs® Ultra-Lite2™ Breathable Polypropylene Rainsuit

Low-cost option great for crews

Sweat-free rainwear has patented bi-laminate technology with “welded” waterproof seams. Ultra-lightweight nonwoven polypropylene is totally waterproof and highly breathable. Pants have wide bottoms to fit over boots. Folds down to storage-pocket size - handy insurance against Mother Nature for workdays in the field, at the landscaping site or manicuring the golf course. Includes carrying pouch. Specify color.

Item #	Size	Price	
224183	S-2XL	\$21.99	<div style="display: flex; flex-direction: column; gap: 5px;"> <div> Blue</div> <div> Forest Green</div> <div> Khaki</div> <div> Yellow</div> </div>



Men's Overlook Rain Jacket

Everybody needs a great waterproof jacket close at hand - in your truck, pack or tool shed. 100% waterproof and breathable polyester, with taped seams, zip front with storm flap, adjustable hem and hood, full mesh lining, elastic cuffs and lined hand-warmer pockets. Two-layer bonded fabric with a durable, smooth exterior.

Item #	Size	Price
231030	S-3XL	\$90.00



Women's Overlook Rain Jacket

Everyone needs to keep a go-to, 100% waterproof rain jacket close by just in case Mother Nature isn't playing nice. UA Storm technology repels water without sacrificing breathability. Two-layer construction with fully taped seams. Generous three-piece hood, mesh drop liner and zippered hand pockets with warm, brushed lining.

Item #	Size	Price
231033	S-L	\$90.00

Stay cooler on the job
 with sweat-wicking apparel from
Under Armour
 Tech T's and Polos • Hats
 Baselayer • Shirts and more!



NEW

Columbia Men's Top Pine™ Insulated Rain Jacket

A full-zip hooded jacket built to keep you dry and warm in wet and chilly conditions. Featuring waterproof/breathable fabric, 60g insulation, zippered hand pockets, and adjustable hood and cuffs. Omni technology, ultrasonic bonding and a drop tail to keep you extra warm.

Item #	Size	Price
1798722	S-2XL	\$130.00



Columbia Men's Glennaker Lake™ Rain Jacket

The perfect quick-fix layer for unpredictable days. It stuffs in its own pocket for easy transport. Omni-Shield™ technology helps you stay clean and dry by resisting absorption of liquids. Waterproof, 100% nylon with mesh lining, stowaway hood, zip pockets, adjustable cuffs and drawcord hem. Specify color.

Item #	Size	Price	Color
231072	S-XXL Reg.	\$39.99	Black
231072	LT-2XLT Tall	\$49.99	Tusk



Columbia Men's Watertight™ II Rain Jacket

Stay cooler and drier while working, hiking or biking. Omni-Tech™ technology provides protection that's waterproof and breathable, guaranteed. Stuffs in its own pocket so you can keep it close by when bad weather blows in. Mesh lining, adjustable storm hood, zip pockets, drawcord hem, abrasion-resistant chin guard and a drop tail for additional coverage. Specify color.

Item #	Size	Price	Color
231073	S-XXL Reg.	\$59.99	Graphite
231073	LT-2XLT Tall	\$69.99	Collegiate Navy



Columbia Men's Rebel Roamer™ Rain Pants

Stay cool and dry in these waterproof/breathable rain pants. Nylon locks out rain, but lets sweat escape. Drawcord elastic waist provides easy-moving comfort. Adjustable leg openings for easy on/off with any kind of footwear.

Item #	Size	Price
231074	S-XXL	\$50.00



NEW

Columbia Women's Top Pine™ Insulated Rain Jacket

Weather turning wet and cold? No problem, in this waterproof/breathable rain jacket with lightweight insulation. The front and pocket zippers are treated to keep moisture out, while the brimmed hood shields against a surprise shower.

Item #	Size	Price
1800351	XS-XL	\$130.00



Columbia Women's Switchback™ III Jacket

This jacket is the perfect quick-fix layer for unpredictable days. Plus, it stuffs in its own pocket for easy transport. Waterproof 100% nylon with a mesh lining. Stowaway hood, zip pockets, adjustable cuffs and drawcord hem. Specify color.

Item #	Size	Price	Color
231082	XS-XL	\$39.99	Black
231082	2XL-3XL	\$49.99	Fuchsia
			Miami



Columbia Women's Arcadia™ II Rain Jacket

You stay cooler and drier while working, hiking or biking in this waterproof/breathable rain jacket. Omni-Tech™ technology locks out rain, but lets sweat escape. Stuffs in its own pocket so you can have it close by when bad weather blows in. Mesh lining, adjustable storm hood, zip pockets, drawcord hem and more. Fully seam sealed. Specify color.

Item #	Size	Price	Color
231083	XS-XL	\$59.99	Geyser
231083	2XL-3XL	\$69.99	Columbia Navy
			Black



Columbia Women's Storm Surge™ Rain Pants

Constructed of Omni-Tech™ nylon that locks out rain, but lets sweat escape - keeping you dry, cool and comfortable. Drawcord elastic waist provides easy-moving comfort. Adjustable leg openings for easy on/off with any kind of footwear.

Item #	Size	Price
231084	XS-3XL	\$50.00



Disposable Rain Ponchos, Pkg. of 12

Great for sudden weather changes

Low price will keep your budget on track. Lightweight, 100% waterproof, one-time-use, polyethylene ponchos are perfect for emergencies. Store easily in your vehicle, tool bag or pocket. One size fits most. Specify color.

Item #	Price	
167410	\$14.99	Blue
		Yellow
		Clear
		Orange



PERSONALIZE



Air Weave® Breathable Polyurethane Poncho

Universal sizing makes it easy to outfit crews

Now here's a rain poncho that lasts! The patented, breathable Air Weave material handles repeated washings, resists snags and tears, and won't mildew. Unique, one-piece design provides full protection with no restriction of movement. Drawstring hood protects your face and head from cold, wet conditions. This is a great spare behind your truck seat or in your tractor cab. 45"L. Specify color.

NOTE: Not recommended around moving machinery.

Item #	Price	
973SR	\$54.99	Black
		Yellow
		Green
		Orange



PERSONALIZE



PVC Riding Slicker/Pommel Coat

Thicker .35mm PVC-over-polyester material, with welded seams to protect against rip-outs. Cape back features two mesh holes for ventilation. Legs are split with snaps to form leg openings for ATV or saddlewear. Left or right snap-front option with front storm flap. Convenient patch-type front storage pockets on outside right and inside left. Corduroy collar is soft against the neck. Back length is 58". Detachable hood included.

Item #	Color	Size	Price
G22600	Yellow	M-5XL	\$29.99



PERSONALIZE

carhartt **Full Swing® Armstrong Jackets**

Allow full range of motion without the jacket riding up

12-oz., 100% cotton sandstone duck canvas is wind resistant and lined with fleece for warmth. Stretch panels between the shoulders and at the elbows allow full range of motion. Features include two lower front pockets, chest pocket with zipper and rib-knit storm cuffs. **230784** (Carhartt 103371) has an attached, fleece-lined hood with adjustable drawstring closure, rib-knit waist and 28" back length (Large Regular). **230785** (Carhartt 103370) has an open waist, a corduroy collar and a 29.5" back length (Large Regular). Specify color for 230784.

Item #	Description	Size	Price
230784	Hooded Active Jac	S-2XL Reg.	\$129.99
230785	Unhooded Jacket	S-2XL Reg.	\$129.99

CARHARTT FULL SWING

Engineered to maximize range of motion and comfort

Full Swing workwear fits closer to the body but moves with you while you swing, lift and crouch.

- Rugged Flex™** stretch technology provides better freedom of movement.
- Freedom Gasset™** underarms and bi-swing back give shoulders and arms room to move freely.
- Flex Elbow™** technology increase range of motion.
- Mighty Back™** stretch technology between the shoulders provides instant fabric recovery.



PERSONALIZE

carhartt **Full Swing® Traditional Coat**

A Carhartt classic with high tech features

Constructed of 10-oz., 100% ringspun washed cotton duck. Nylon quilted lining has 80g of 3M™ Thinsulate™ insulation for warmth. Mighty Back® bi-swing technology across the shoulders for instant recovery and non-binding comfort. Two-way center front zipper with snap and hook-and-loop flap to seal out the elements. Finishing touches include a corduroy collar. Back length 29.5" (Large Regular) and 31.5" (Large Tall). Carhartt 103283. Specify color.

Item #	Size	Price	
230783	3XL Reg., LT-2XLT Tall	\$164.99	<div style="display: flex; flex-direction: column; gap: 5px;"> <div> Black</div> <div> Dark Brown</div> <div> Brown</div> </div>



PERSONALIZE



J140 Firm Duck Flannel-Lined Active Jac

Keeps you warm in a wide range of temperatures

Features 100% polyester quilted flannel lining and quilted nylon-lined sleeves. This water repellent jacket has a heavy-duty metal zipper that's super durable and easy to handle. Roomier fit gives you a better range of motion. Rib-knit cuffs and bottom band help this coat keep the cold air out and warm air in.

Item #	Size	Price	
G20140	3XL-5XL Reg., MT-4XLT Tall	\$109.99	Dark Navy
	S-2XL Reg.	\$99.99	Brown
			Black
			Red



PERSONALIZE



J130 Sandstone Duck Flannel-Lined Active Jac

Prewashed cotton duck for a comfortable fit that feels broken in from the start

Soon to be your favorite work coat for its supreme durability and broken-in comfort. Durable 12-oz. cotton duck outer material stands up to tough conditions. Quilted flannel lining keeps you warm on the coldest days. Inside pocket with zipper closure on the right side allows you to securely store your wallet, cell phone or other valuables, plus additional inside patch pocket on the left provides added space for storage. Specify color.

Item #	Size	Price
G22130	S-2XL Reg.	\$74.99
G22130	3XL-5XL Reg., MT-4XLT Tall	\$82.49

- Brown
- Black
- Dark Brown
- Moss
- Frontier Brown
- Brown



PERSONALIZE



J131 Firm Duck Thermal-Lined Active Jac

Keep warm in spring, summer and fall

Protect yourself in tough work environments with this lightweight, thermal-lined jacket. Durable 12-oz. firm cotton duck outer material. Four pockets, including front hand-warmer pockets and two inside pockets—one with a zipper to hold your valuables. Stretch nylon rib-knit cuffs and waistband. Drawstring hood help keep the cold out. Specify color.

Item #	Size	Price	
20131	S-6XL Reg.	\$79.99	Brown
	3XL-5XL Reg., LT-4XLT Tall	\$89.99	Dark Navy
			Black



PERSONALIZE



Rigby Rugged Flex® Canvas Shirt Jac

Provides an easier-moving feel

It's a classic shirt jac like your Grandpa wore, but Carhartt packs it with work-friendly features. Plus, it is made out of the softest feeling material around. Stretches in all the right places with 98% cotton/2% spandex stretch canvas. Keeps you warm on chilly mornings with a full fleece lining. And, organize your gear with two lower pockets, two chest pockets - left one zips closed to keep your phone secure. Specify color.

Item #	Size	Price	
102851	M-2XL Reg.	\$69.99	Dark Khaki
			Shadow

**NEW****Carhartt Gilliam Jacket**

It has a real easy-moving feel and Carhartt's reliable Rain Defender® finish if you get stuck in a storm. Rugged, yet supple, 100% nylon with drawstring hood, hand-warmer pockets, interior pockets and a chest pocket for your cell phone. Machine wash. Specify color.

Item #	Size	Price	
102208	3XL Reg., LT-2XLT Tall	\$109.99	Black
102208	S-2XL Reg.	\$99.99	Shadow

**NEW****Carhartt Hubbard Sherpa-Lined Flannel Shirt Jac**

It's Carhartt's beefy Hubbard cotton flannel shirt, warmed up with a faux shearling fleece lining. Bet you won't even need your coat. Chest pockets, plus side pockets to warm your hands. Snap front with nylon-lined sleeves for easy on and off. Roomy cut; relaxed fit. Machine wash. Specify color.

Item #	Size	Price
103821	S-2XL Reg.	\$59.99
103821	3XL-4XL Reg., LT-3XLT Tall	\$67.49

**PERSONALIZE****Carhartt Firm Duck Arctic-Lined Work Coat**

Stay toasty with Carhartt's warmest arctic quilt lining

Traditional unwashed 12-oz. cotton duck makes it a customer favorite. Roomy slash pockets, chest patch pockets, rib-knit cuffs and internal drawcord at waist. Bi-swing back provides a wide range of movement. Brass zipper has a protective flap with hook-and-loop closure. Large regular is 31"L; tall is 33"L. C003. Specify color.

Item #	Size	Price	
193091	S-2XL Reg.	\$119.99	Black
193091	3XL-4XL Reg., LT-3XLT Tall	\$129.99	Brown
			Dark Navy



NEW

carhartt Women's Utility Coat

Hardworking as you'd expect, with water-repellent nylon shell, sherpa fleece lining, adjustable hood and seven pockets. It's got a style all its own - you'll reach for it every time you go out the door. Mid-thigh length - goes over big sweaters and sweatshirts. Full zip front with snap storm flap, internal rib-knit cuffs, cinch-adjust waist and much more.

Item #	Price
103908	\$97.49



NEW

carhartt Women's Shoreline Jacket

There's a reason why the Shoreline is the most popular waterproof jacket we make, it features Storm Defender® technology. This women's jacket not only keeps you dry in heavy rain, it's also breathable, versatile and equipped with plenty of pockets. Weighing 4.8 oz., this lightweight layer has thumbhole cuffs that can be tucked into sleeves. Features zip pockets, flap pockets and inner pockets for your essentials.

Item #	Size	Price
102382	XS-2XL	\$119.99



NEW

carhartt Women's Smithville Jacket

Are work jackets supposed to feel this good? Carhartt thinks so. Rugged Flex® technology for all-day, easy-moving comfort. 64% cotton/36% nylon ripstop. Eight pockets, adjustable drawcord waist, adjustable cuffs and zip front with button storm flap.

Item #	Size	Price
103053	XS-2XL	\$59.99



PERSONALIZE

carhartt WJ130 Women's Flannel-Lined Active Jac

This women's active jac has a 12-oz. cotton duck outer that is prewashed for a softer, more comfortable feel. Quilted flannel lining keeps you warm. Three-piece hood, rib-knit cuffs and waistband help seal in warmth and block the elements. Size medium back length is 27.5". Specify color.

Item #	Size	Price	
145980	XS-2XL	\$74.99	<div style="display: flex; align-items: center;"> <div style="width: 15px; height: 15px; background-color: #4b3621; margin-right: 5px;"></div> Dark Brown </div> <div style="display: flex; align-items: center;"> <div style="width: 15px; height: 15px; background-color: #8b6914; margin-right: 5px;"></div> Brown </div> <div style="display: flex; align-items: center;"> <div style="width: 15px; height: 15px; background-color: #4b3621; margin-right: 5px;"></div> Dusty Plum </div>



NEW **PERSONALIZE**

Wrangler Chore Jacket

It's got the kind of laidback look you like. With a weather-resistant ripstop cotton shell and Heatseeker poly-fill insulation to keep you warm and dry on all the crummiest days. Snap chest pocket for your cell, plus hand-warmer pockets. Zip front, stand-up collar, elasticized cuffs. Machine wash.

Item #	Size	Price
231223	M-2XL Reg., LT-2XLT Tall	\$79.99





NEW **PERSONALIZE**

Men's Telemark Softshell Jacket

High-performance waterproof softshell

Great features at an unbeatable price! Waterproof fabric to 1,000mm. Breathable fabric with bonded microfleece lining. Adjustable Velcro® cuffs. Full zip. Specify color.

Item #	Size	Price	
193193	M-2XL	\$50.00	 Navy
			 Black
			 Pistol



NEW **PERSONALIZE**

Women's Telemark Softshell Jacket

High-performance waterproof softshell

Great features at an unbeatable price! Waterproof fabric to 1,000mm. Breathable fabric with bonded microfleece lining. Adjustable Velcro® cuffs. Full zip. Specify color.

Item #	Size	Price	
193194	S-XL	\$50.00	 Black
			 Navy
			 Fog



NEW



Men's Steens Mountain™ 2.0 Full Zip Fleece Jacket

The next generation of our Steens Mountain™ line, this outdoor staple features a finely tuned fit and a soft, durable polyester fleece to keep you warm no matter what. Modern classic fit. Zippered security pocket for small items. Specify color.

Item #	Size	Price	
1476671	S-2XL	\$39.99	Charcoal Heather
1476671	3XL-5XL	\$39.99	Collegiate Navy
			Black, Grill
			Black



NEW



Men's Utilizer™ Jacket

Water-resistant 100% nylon shell sheds light rain, while the 100% polyester microfleece lining and 100% polyester 60g Microtemp XF II Insulation keeps you warm. Three pockets, all with zipper closures, are well-placed for storage and hand-warming. This Columbia jacket is finished with adjustable, partial-elastic cuffs and a drop tail for extra coverage in back. Specify color.

Item #	Size	Price	
1771571	S-2XL	\$59.99	City Grey
			Black



NEW



Women's Benton Springs™ Full Zip

This modern-classic fleece zip-up is perfect to layer on top or underneath other layers. Zippered hand pockets keep small items secure. Perfect to keep you warm in the winter! Specify color.

Item #	Size	Price	
1372111	XS-XL	\$34.99	Black
			Charcoal Heather
			Dark Seas



NEW



Women's Canyon Point™ II Shirt Jac

Soft, comfortable flannel button up meets cozy hoodie on this staple piece of the cool-weather season. Features a flattering cut that's great for layering, with drawcord adjustability at the hood. Specify color.

Item #	Size	Price	
1739321	XS-XL	\$54.99	Black Check
			Crystal Blue



carhartt Gilliam Vest

Cordura® nylon is a tough, lightweight warmer

A vest can be your best friend three seasons of the year - the little bit of warmth you need. This one is tough as they come with Cordura nylon that shrugs tears, scuffs and abrasions. Rain Defender® finish keeps you dry in a light drizzle. Quilted nylon lining adds insulation. Three pockets outside, two inside (one zips closed). Droptail hem. Specify color.

Item #	Size	Price	
102286	S-2XL	\$79.99	Black
			Blue



PERSONALIZE

carhartt Sandstone Duck Arctic-Lined Vest

Prewashed for a softer feel right out of the box

Nylon lining quilted to arctic-weight polyester insulation keeps you warm, while durable 12-oz., 100% cotton sandstone duck outer provides long wear. Generous, insulated front pockets. Metal zipper front, soft rib-knit collar and an inside left pocket with hook-and-loop closure. 3.5" extended tail. Large regular is 27.25"L, Tall is 29.25"L. V02. Specify color.

Item #	Size	Price	
125631	XL	\$59.99	Brown
125631	4XL	\$64.99	Dark Brown
			Midnight Blue



PERSONALIZE

carhartt Quick Duck® Nylon-Lined Jefferson Vest

Durable 8.5-oz., 60% cotton, 40% polyester Quick Duck canvas vest with Rain Defender® durable water-repellent finish. 30% lighter and ounce for ounce as durable as sandstone. Nylon lining is quilted to 80g 3M™ Thinsulate™ insulation. Two-way center front zipper has an inner storm flap. Two inside pockets. Drop tail for extra coverage. Large regular back length is 28.5L; large tall is 30.5"L. Carhartt 101494. Specify color.

Item #	Size	Price	
225711	M	\$67.49	Black
225711	3XL	\$74.99	Canyon Brown
			Charcoal



NEW

carhartt Women's Mock Neck Vest

Tough, toasty and a Carhartt standby for years. 100% cotton sandstone duck with mock neck and sherpa fleece lining. Four pockets and a zip front with inside storm flap. Drop tail for added coverage.

Item #	Price
WV001	\$52.49



PERSONALIZE



Class 2 Hi-Vis Vest

Improved ventilation keeps you cool in hot conditions
 Ultra-Cool™ polyester mesh front and back keep you cooler. Feature 2"W VizLite® reflective material. 4"L zipper front closure and left-side chest pocket. Machine washable. Meet ANSI/ISEA 107 Class 2.

Item #	Size	Price	
109625	M-3XL	\$15.99	Orange Lime



PERSONALIZE



Class 2 Hi-Vis Breakaway Vest

Comes apart if caught or snagged
 The shoulders, side seams and front closure all break away if the vest gets entangled in machinery, hooked on a vehicle or snagged by a tool. Inside two-tier, four-division pencil pocket; inside lower-right patch pocket and inside-right cell phone pocket. 2"W silver reflective material with 4.5"W contrasting color. Meets ANSI Class 2.

Item #	Color	Size	Price	
157906	Lime	M-4XL	\$16.99	Lime Orange
157907	Orange	M-5XL	\$16.99	



PERSONALIZE



Class 2 Hi-Vis Black-Bottom Vest

Loaded with pockets
 Ultra-Cool™ 100% polyester mesh material with 2"W silver reflective material. Solid black polyester band on lower front helps hide dirt and grime. Features left and right chest mic tabs, two lower patch pockets with flaps, a left chest radio pocket, a right chest two-tier pocket, and two large lower inside pockets. Zipper-front closure. Meets ANSI/ISEA 107-2010 Class 2.

Item #	Size	Price
211838	M-5XL	\$15.99



PERSONALIZE



Class 2 Vest with Wide Reflective Striping

Ultra-Cool™ mesh front and back keeps you cool
 Brilliant base colors are overlaid with contrasting 4.5"W stripes with 2"W silver reflective material. Front zipper closure. Two-tier, four-division pencil pocket. Meets ANSI/ISEA 107 Class 2.

Item #	Color	Size	Price	
109629	Orange	M-2XL	\$15.99	Orange Lime
109630	Lime	M-3XL	\$15.99	



Water beads up and rolls right off

Stay drier ... longer!

Rain Defender™ Durable Water-Repellent Finish

Moisture simply beads up and rolls off the garment, meaning rain, mist and snow have met their match. Super tough—retains 70% of its strength even after 20 washings. This rugged, high-performance gear is a must for any outdoor worker!



PERSONALIZE

carhartt Rain Defender® Hooded Sweatshirts

Your three-season solution to cold and rain

Paxton Unlined - Heavyweight, 13-oz., 80% cotton, 20% polyester. Jersey-lined hood. One hand-warmer pocket. **Rutland Thermal-Lined Zip Front** - 12-oz., 50% cotton, 50% polyester. 100% polyester thermal lining throughout. Hidden security pocket in one hand-warmer pocket. Specify color.

Item #	Size	Description	Price
224413	S-2XL Reg.	Rutland Thermal-Lined Zip Front	\$52.49
224407	S-2XL Reg.	Paxton Zip Front	\$59.99
224409	S-2XL Reg.	Paxton Quarter-Zip Pullover	\$59.99
224413	3XL-4XL Reg., LT-3XLT Tall	Rutland Thermal-Lined Zip Front	\$59.99
224407	3XL-4XL Reg., LT-3XLT Tall	Paxton Zip Front	\$64.99
224409	3XL-4XL Reg., LT-3XLT Tall	Paxton Quarter-Zip Pullover	\$64.99
224413	S-2XL Reg.	Rutland Thermal-Lined Zip Front	\$69.99
224413	XLT Tall	Rutland Thermal-Lined Zip Front	\$74.99
224413	3XL-4XL Reg., LT-3XLT Tall	Rutland Thermal-Lined Zip Front	\$79.99



PERSONALIZE

carhartt Midweight Hooded Sweatshirts

Generously cut for cold-weather layering

Made from 10.5-oz., 50% cotton, 50% polyester fleece. Spandex-reinforced rib-knit cuffs and bottom band for strength and elasticity. **Pullover** – Attached drawstring hood and front hand-warmer pouch. K121. **Zip-Front** – Attached drawstring hood and two front hand-warmer pockets. K122. Specify color.

NOTE: Heather gray sweatshirt is 70% cotton/30% polyester.

Item #	Size	Description	Price
G20121	S-2XL Reg.	Pullover	\$39.99
G20121	3XL-4XL Reg., LT-3XLT Tall	Pullover	\$44.99
G21028	S-2XL Reg., XLT Tall	Zip Front	\$44.99
G21028	S-2XL Reg., XLT Tall	Zip Front	\$44.99
G21028	3XL-4XL Reg., LT-3XLT Tall	Zip Front	\$49.99

-  Black
-  Navy
-  Heather Gray
-  Dark Brown
-  Gray



NEW



Midweight Hooded Logo Sweatshirt

Beefy and comfortable 10.5 oz., 50% cotton/50% polyester fleece, great on its own or layered under your work jacket, rainsuit or parka. Drawcord hood, roomy front pocket, plus rib-knit cuffs and waistband. And, of course, that reassuring Carhartt logo on the sleeve. Original fit. Specify color.

Item #	Size	Price	
K288	S-2XL Reg.	\$33.74	Carbon Heather
K288	3XL Reg., LT-3XLT Tall	\$37.49	Black
K288	S-2XL Reg.	\$44.99	Bold Blue Heather
K288	3XL Reg., LT-3XLT Tall	\$49.99	



NEW



Crewneck Pocket Sweatshirt

It's the same kind of beefy cotton fleece sweatshirt you grew up with - 10.5 oz. 50% cotton/50% polyester. The extra warmth you need over a t-shirt or under a rainsuit. Relaxed fit. Specify color.

Item #	Size	Price	
103852	S-2XL Reg.	\$39.99	Black
103852	3XL-4XL Reg., LT-2XLT Tall	\$44.99	Carbon Heather
			New Navy



NEW



Force® Delmont Signature Graphic Hooded Sweatshirt

The high-tech 8.8 oz., 58% cotton/42% polyester fleece shrugs off stains and wicks away sweat. Drawcord hood, roomy front pocket, rib-knit cuffs and waistband. Relaxed fit. Specify color.

Item #	Size	Price	
103873	S-2XL Reg.	\$49.99	Moss Heather
103873	3XL-4XL Reg., LT-3XLT Tall	\$54.99	Navy Heather



NEW



Women's Clarksburg Crewneck Pocket Sweatshirt

Now you've got a place for your cell phone, keys or work orders. 55% cotton/45% polyester fleece is as beefy as the sweatshirts you remember and provide a cozy soft layer on extra-cold winter days. Rib-knit cuffs and waistband. Chest pocket. Relaxed fit. Specify color.

Item #	Size	Price	
103925	XS-2XL	\$29.99	Navy Space Dye
103925	XS-2XL	\$39.99	Fudge Heather
			Black



NEW



Men's Armour Fleece Hoodie

You expect Under Armour to create a great hoodie.. right? Well, this one is light, breathable and stretchy polyester with a full cut and an inner layer that traps heat for warmth in the coldest parts of winter. Adjustable hood, front kangaroo pocket, ribbed cuffs and hem. Specify color.

Item #	Size	Price	
231128	S-3XL	\$55.00	<div style="display: flex; flex-wrap: wrap;"> <div style="width: 50%;"> Black Steel Light Heather Academy </div> <div style="width: 50%;"> Calla Medium Heather Steel Medium Heather Level Purple </div> <div style="width: 50%;"> Black Onyx Steel Light Heather Black </div> </div>



NEW



Women's Rival Fleece Sportstyle Graphic Hoodie

What makes it so darn comfortable? 80% cotton/20% polyester and fleecy soft inside. Relaxed fit and raglan sleeves for extra freedom of movement. Drawstring hood, front kangaroo pocket, ribbed cuffs and hem. Specify color.

Item #	Size	Price
231130	XS-2XL	\$50.00
231130	XS-2XL	\$55.00

	Calla Medium Heather		Black Onyx
	Steel Medium Heather		Steel Light Heather
	Level Purple		Black



PERSONALIZE



Double-Thick Zip-Front Hooded Sweatshirt

They don't come any "beefier" than this

Wears like a thick, comfy jacket. Two layers of 12-oz. prewashed, preshrunk 100% cotton fleece for the ultimate in warmth. Gusseted armpit offers exceptional range of motion. Heavy-duty YKK zippered front is backed with a fabric storm flap that prevents cold air from entering. Two large side-entry front pockets, plus an interior zippered pocket. Specify color.

Item #	Size	Price	
162091	M-3XL	\$99.99	<div style="display: flex; flex-wrap: wrap;"> <div style="width: 50%;"> Forest Green Navy </div> </div>



NEW

PERSONALIZE

Pullover Hoodie

This sweatshirt is an 8-oz. cotton/polyester blend that keeps you warm and comfortable in the cooler months. Features a softer feel and reduced pilling, double-lined hood with matching drawstring and pouch pocket. Double-needle cuffs and waistband for extra durability. Specify color.

Item #	Size	Price	
195600	S-XL	\$19.99	
195600	2XL	\$24.99	
195600	3XL	\$27.49	



NEW



Hubbard Plaid Flannel Shirt

Long-sleeve shirt is constructed of a hearty 8-oz., 100% cotton flannel that is garment washed for immediate softness and shrink resistance. Shoulder pleats make it easier to bend, stretch and raise a hammer or an axe. Spread collar, adjustable cuffs and flap pockets. Original fit. Specify color.

Item #	Size	Price	
103822	S-2XL Reg.	\$33.74	Black
103822	3XL-4XL Reg., LT-3XLT Tall	\$37.49	Steel Blue
			Dark Crimson



NEW



Women's Rugged Flex® Hamilton Flannel Shirt

Better compare before you buy a flannel elsewhere! It's garment-washed for immediate softness. Has a little spandex stretch – 97% cotton/3% spandex, to be exact, and gives you the relaxed fit that makes bending, stretching and working easier. Chest pockets, adjustable cuffs and triple-stitched seams. Specify color.

Item #	Size	Price	
103226	XS-2XL	\$29.99	Gravel
			Henna



NEW



Women's Rugged Flex® Hamilton Fleece-Lined Flannel Shirt

Always shivering - get a fleece-lined flannel

All the great comfort features of our regular Rugged Flex flannel - garment-washed softness, 97% cotton/3% spandex stretch, relaxed fit - plus a fleece lining that'll keep you toasty indoors or out. Can be worn as a light jacket or as your all-day work shirt. Two chest pockets, plus hand-warmer pockets for cold fingers. Button front with straight collar. Specify color.

Item #	Size	Price	
103239	XS-2XL	\$44.99	Balsam Green
			Sparrow



PERSONALIZE



Premium Twill Shirts

Rugged durability and professional appearance
 These premium uniform shirts are built for hard work, but they also contain a stain-release finish and moisture-wicking properties to keep your crew looking professional. Made from 5.25-oz., 65% polyester/35% cotton twill that has a generous fit in the shoulder and sleeve for comfort and a greater range of motion. Specify color.

Item #	Size	Sleeve	Price	Color
218876	S-2XL Reg.	Short	\$24.99	Black
218877	S-2XL Reg.	Long	\$26.99	Desert Sand
218876	3XL-5XL Reg., XLT-3XLT Tall	Short	\$26.99	Navy
218877	3XL Reg., MT-4XLT Tall	Long	\$29.99	Navy



PERSONALIZE



Basic Industrial Work Shirts

Made of 4.25-oz., 65% polyester/35% cotton poplin, these dependable work shirts are fade and wrinkle resistant. Feature a lined, two-piece collar with permanent stays and a snap closure. Pencil division on left pocket. Specify color.

Item #	Size	Sleeve	Price	Color
218878	S-2XL Reg.	Short	\$17.99	Black
218879	S-2XL Reg.	Long	\$19.99	Desert Sand
218878	3XL-5XL Reg., LT-3XLT Tall	Short	\$21.99	Navy
218879	3XL-5XL Reg., MT-3XLT Tall	Long	\$21.99	Navy



PERSONALIZE



Cotton Twill Long-Sleeve Shirt

Shirt has a side gusset designed to move when you move. You can lift, twist, reach or make any movement without your shirt fighting back. 7-oz., 100% cotton twill material has a relaxed-fit design and extended tail that will make this your most comfortable work shirt. Features button-down collar, button-adjustable cuffs and two chest pockets. Specify color.

Item #	Size	Price	Color
109910	M-2XL Reg., XLT-2XLT Tall	\$36.99	Forest Green
			Khaki



Columbia PFG Tamiami™ II Long-Sleeve Shirt

Lightweight fishing shirt has UPF 40 sun protection
 Shirt is cool and quick to dry. Provides UPF 40 sun protection - just what you need out on the water. Two vertical back vents are mesh lined for extra cooling power. Sleeves roll up and secure with tabs. Two front pockets, each with a smaller Velcro® pocket on top. Rod holder above the left pocket. Specify color.

Item #	Size	Price	Color
231078	S-XXL	\$48.00	Vivid Blue
			Collegiate Navy
			Gray



Carhartt Force® Delmont Pocket Polo Shirt

Quick-drying fabric keeps you comfortable while working your hardest

Force FastDry® technology wicks away sweat to dry you fast, while Stain Breaker® shrugs away stains. 5.75-oz. 65% cotton/35% polyester plaited jersey knit. Specify color.

NOTE: Heather gray polo contains 59% cotton/41% polyester.

Item #	Size	Price	
103569	S-2XL	\$34.99	Navy
103569	3XL	\$39.99	Heather Grey
			Black



PERSONALIZE

Carhartt Contractor's Pique Polo

Made of 6-oz., 65% polyester/35% cotton pique knit that is colorfast with a stain-release finish for a bright appearance, wash after wash. Features a no-roll knit collar that lays flat and non-banded sleeves to fit your arms more comfortably. Three-button front and square bottom with side vents. K570. Specify color.

NOTE: Because of the pocket on the left side of this shirt, we can only accommodate 1 line of embroidery above pocket.

Item #	Size	Price	
198293	M-2XL Reg.	\$29.99	Moss
198293	3XL-4XL Reg., LT-3XLT Tall	\$34.99	Navy



PERSONALIZE



Men's Tech Polo Shirt

Cool wearing and fights stink, too!

Performance polyester knit wicks away sweat. Antimicrobial to fight odor. Looser, fuller fit for greater freedom of movement. Specify color.

Item #	Size	Price
231029	S-4XL Reg., XLT-2XLT Tall	\$39.99

- Black
- Graphite
- Midnight Navy
- Red
- Royal



NEW

Men's Spin Half-Zip Pullover

Wear it working, running or hiking. It's soft 100% polyester and spin dyed in a sustainable way that's better for the environment. Provides UPF 50+ sun protection and wicks away moisture to keep you dry. Vent the half-zip neck for extra cooling. Machine wash. Specify color.

Item #	Size	Price	
193195	M-2XL	\$20.00	Pistol
			Black
			Navy

PERSONALIZE
carhartt Premium Heavyweight Shirts

Prewashed 6.75-oz., 100% cotton is great for year-round wear. Wide range of sizes provide an excellent value for crews. Handy left-front chest pocket with Carhartt patch. Rib-knit collar. Traditional three-button Henley gives you a more finished appearance. Specify color.

NOTE: Heather gray shirt is 90% cotton/10% polyester.

Item #	Size	Description	Price
G21087	S-2XL	K87 Short-Sleeve T-Shirt	\$16.99
109702	S-2XL Reg.	K84 Short-Sleeve Henley	\$19.99
21126	S-2XL Reg.	K126 Long-Sleeve T-Shirt	\$22.99
125954	S-2XL Reg.	K128 Long-Sleeve Henley	\$24.99
109702	3XL-4XL Reg., LT-3XLT Tall	K84 Short-Sleeve Henley	\$24.99
21126	3XL-4XL Reg., LT-3XLT Tall	K126 Long-Sleeve T-Shirt	\$27.99
125954	3XL-4XL Reg., LT-3XLT Tall	K128 Long-Sleeve Henley	\$29.99

 Black	 Port	 Charcoal
 Heather Gray	 Dark Brown	 Red
 Hunter Green	 Desert	 Stream Blue
 Navy	 Bluestone	 Army Green

Need more info? Visit gemplers.com or call 800-382-8473 for product details.



Force® Delmont Graphic Moisture Wicking T-Shirt

Midweight shirt made of sweat-fighting fabric

Force FastDry® technology wicks away sweat to dry you fast, while Stain Breaker® shrugs away stains. Specify color.

NOTE: Black T-shirt contains 65% cotton/35% polyester.

Item #	Size	Price	
102549	S-2XL	\$24.99	Light
102549	3XL-4XL	\$29.99	Huron
			Heather
			Carbon
			Heather
			Black



PERSONALIZE

Force® Delmont Moisture Wicking T-Shirt

Two-layer, 5.75-oz. plaited jersey knit—cotton/polyester blend on the outside—that draws moisture away from your skin and wicks it away. Stain-release finish. Carhartt 100410. Specify color.

Item #	Size	Price
214600	S-2XL Reg.	\$21.99
214600	3XL-4XL Reg., LT-3XLT Tall	\$26.99



NEW

Signature Logo Long-Sleeve T-Shirt

This long-sleeve T-shirt bears the name proudly on the sleeve. It's made of heavyweight cotton jersey and cut generously for a roomy fit. Rib-knit crewneck and cuffs hold their shape. Tagless neck label. K231. Specify color.

Item #	Size	Price
231123	S-2XL Reg.	\$18.74
231123	3XL-4XL Reg., LT-3XLT Tall	\$22.49
231123	S-2XL Reg.	\$24.99
231123	3XL-4XL Reg., LT-3XLT Tall	\$29.99



PERSONALIZE

Class 3 Force® Hi-Vis Long-Sleeve T-Shirt

Designed to keep you cool, dry and visible on the worksite. 4-oz. bird's eye knit fabric wicks sweat away and features stain-fighting technology. 3M™ Scotchlite™ reflective material is also vented, allowing more body heat to escape. Plus, rips and snags only damage a small portion of the tape (solid strips often peel when snagged). ANSI Class 3, Level 2 compliant. Carhartt 100496.

Item #	Size	Price	
214478	M-2XL Reg.	\$36.99	Lime
214478	3XL-4XL Reg., LT-3XLT Tall	\$41.99	Orange



PERSONALIZE



Long-Sleeve Henley Shirt

Roomy fit and vented side seams give you the perfect amount of climate control when you're working up a sweat in cooler spring or fall temperatures. Hidden front-pocket utility loop keeps small tools handy. 7-oz., 100% cotton jersey. Tagless neck label for a comfortable feel.

Item #	Size	Price	
218697	M-2XL	\$23.99	Ash Heather
218697	3XL-4XL	\$26.99	Oatmeal Heather



PERSONALIZE



Short-Sleeve Pocket T-Shirt

7-oz., 100% cotton-jersey T-shirt is sure to be your new favorite. Features a roomy relaxed fit, sturdy rib-knit crewneck collar, left chest pocket and vented side seam construction. Features a hidden utility loop inside the left chest pocket which is great for keeping track of your construction pencil, sunglasses or any other small items. Tagless neck label. Specify color.

Item #	Size	Price
151345	M-2XL Reg., LT-2XLT Tall	\$19.99
151345	M-2XL Reg.	\$21.97

Ash Heather	Lime
Burgundy	Forest Green
Black	Navy



PERSONALIZE



Pocket T-shirts

Heavyweight 6.75-oz., 100% cotton jersey knit construction gives these T-shirts the durability needed to hold up, wear after wear. Relaxed fit gives you plenty of room to move. Tagless neck label for comfort. Left chest pocket. Short-sleeve version has a moisture-wicking fabric that helps to keep you cool and dry in the hot sun. Specify color.

Item #	Size	Sleeve	Price
219005	3XL Reg., LT Tall	Short	\$12.97
219005	M-2XL Reg.	Short	\$12.99
219005	3XL Reg., LT-3XLT Tall	Short	\$14.99
219006	3XL Reg., LT-2XLT Tall	Long	\$14.99

Dark Navy	Ash Gray
Heather Gray	White
Hunter Green	



PERSONALIZE

TINGLEY Hi-Vis Class 2 and 3 T-Shirts

Job Sight™ hi-vis fabric and 2"W reflective tape keep you seen in all conditions. Bird's-eye moisture-management polyester wicks away perspiration to keep you feeling cool and dry. Left chest pocket. Meets ANSI/ISEA 107: short-sleeve is Class 2, long-sleeve is Class 3. Specify color.

Item #	Size	Sleeve	Price
225599	5XL	Long	\$18.74
225598	S-5XL	Short	\$19.99
225599	S-3XL	Long	\$24.99

Lime
Orange



Tech™ 2.0 T-Shirts

Tech tee is your new go-to summer tee

You know how clammy and heavy cotton tees can get? Well this performance polyester knit has a looser, fuller fit for comfort, along with a performance polyester knit that wicks away sweat, even fights odor. Specify color.

Item #	Size	Price
231031	S-5XL	\$25.00

- Academy
- Black
- Red
- Royal
- Steel Light
- Heather



Freedom Flag T-Shirt

Just the bold kind of T-shirt you'll wear the most. Super-soft 60% cotton/40% polyester blend, fully cut for comfort in action. What is UA Freedom? UA Freedom has a singular mission: support & inspire the brave men & women who are dedicated to protecting us, every day. Every time you wear this logo, you're showing your support for those who devote their lives to defending their country helping their communities. Specify color.

Item #	Size	Price	
231037	S-3X	\$25.00	 Green
			 Black
			 Steel
			 Academy



Men's PFG Terminal Tackle™ Long Sleeve T-Shirt

The perfect sun-blocking Fishing Tee

You'll wear this Columbia PFG Terminal Tackle T-shirt for outdoor work, too. It works away sweat using Omni-Wick technology to keep you dry and comfortable. UPF 50 sun protection for those long hours in the sun. Constructed of high-tech 100% polyester. Men's chest size: S (29-32), M (32-35), L (36-39), XL (40-43) or XXL (44-47).

Item #	Size	Price	
231077	S-XXL	\$35.00	 Vivid Blue
			 Green



NEW

carhartt Women's Short-Sleeve Logo T-Shirt

The Carhartt K87 T-shirt debuted in 1992, and it became a fast favorite among the hard-working folks who pulled it on. This women's tee is crafted using the same heavyweight cotton (6.75-oz. cotton jersey), but now with a cut that's all you. Carhartt's signature logo is proudly displayed on the front. Specify color.

Item #	Size	Price	
231119	XS-2XL	\$19.99	<div style="display: flex; flex-wrap: wrap;"> <div style="width: 50%;"> Black Heather Gray </div> <div style="width: 50%;"> Black Gray </div> </div>



PERSONALIZE

carhartt Women's Short-Sleeve Pocket T-Shirt

An old standby, sized for women. Crafted using 6.75-oz. cotton jersey and a cut that's all you. Side-seamed construction minimizes twisting. Rib-knit crewneck, left-chest pocket, tagless neck label. Carhartt 103067. Specify color.

Item #	Size	Price
230854	XS-2XL	\$16.99

Deep Wine	Navy
Black	White
Heather Gray	



PERSONALIZE

carhartt Women's Long-Sleeve Pocket T-Shirt

This long-sleeve shirt is constructed of 6.75-oz. cotton jersey and offers plenty of room to move when working. Side-seamed construction minimizes twisting. Rib-knit crewneck, left-chest pocket, tagless neck label. Carhartt 103244. Specify color.

Item #	Size	Price	
230855	XS-2XL	\$19.99	<div style="display: flex; flex-wrap: wrap;"> <div style="width: 50%;"> Deep Wine Black Navy Heather Gray </div> <div style="width: 50%;"> Black Gray </div> </div>



Women's Tech™ Twist V-Neck T-Shirt

Loose, light and it keeps you cool

Your new go-to tee, for working or working out. Four-way stretch polyester knit moves with you, and wicks away sweat to keep you dry and cool. Antimicrobial to fight odors. Deep v-neck and twist effect for go-anywhere style. Relaxed fit. Specify color.

Item #	Size	Price
231035	XS-XXL	\$24.99

Green Haze	Black
Pitch Gray	Purple
Blue Haze	



NEW

Carhartt Rugged Flex Relaxed Straight Jean

Double shifts or 14-hour days. These jeans are made of durable, abrasion-resistant denim with stretch for easy movement. Straight-leg jeans are cut for a relaxed fit, with extra room in the seat and thigh. Specify color.

Item #	Waist Size	Inseam	Price	Color
231107	30"-44"	30"-36"	\$44.99	Superior
231107	46"	30"-32"	\$49.99	Coldwater



NEW

Carhartt Men's Loose Fit Work Dungaree

Built in our roomiest fit, these men's jeans have a full seat and thigh to keep you comfortable on the job. They're made of midweight denim for long-lasting durability. Multiple pockets give you plenty of storage for your tools.

Item #	Waist Size	Inseam	Price
231121	28"-44"	28"-36"	\$39.99
231121	46"-54"	28"-34"	\$44.99



NEW

Carhartt Relaxed Fit Holter Jeans

These men's jeans are made with a tough, midweight denim. Relaxed-fit jeans have a straight leg opening that fits over boots. Specify color.

Item #	Waist Size	Inseam	Price	Color
231101	28"-44"	28"-36"	\$34.99	Bed Rock
231101	46"-54"	30"-32"	\$39.99	Frontier



NEW

Straight Traditional Fit Elton Jeans

These jeans have a trim yet easy-moving fit, with enough room at the bottom to go over most boots. Midweight 12-oz. denim in a special 82% cotton/18% polyester blend that wears as hard as many 15-oz. jeans. Five handy pockets. Let's face it, you'll just plain feel better in them! Straight fit.

Item #	Waist Size	Inseam	Price
101496	30"-44"	30"-36"	\$34.99
101496	46"	30"-32"	\$39.99



carhartt Loose Fit Washed Dungarees

Broken-in fit and feel

11.75-oz., 100% cotton denim dungarees are looser-fitting with more room in the legs. Triple-stitched seams prevent tear-out and hold their shape. Stand up to dirt and repeated washings. Plenty of pockets. Zipper fly. 19" leg opening fits over work boots. Darkstone. B13.

Item #	Waist Size	Inseam	Price
WU388	28"-46"	28"-36"	\$39.99
WU388	46"-54"	30"-32"	\$44.99



carhartt Loose Fit Logger Jeans

Double-layer knees wear longer

Heavy-duty, 15-oz. coarse-weave cotton denim has a broken-in feel and is excellent for work in brush or cool temperatures. Chap-type double-layer front extends from bottom of waist pockets to below the knee. Three tool pockets and hammer loop. 19" leg opening. Darkstone. B73.

Item #	Waist Size	Inseam	Price
20300	28"-44"	30"-36"	\$44.99



carhartt Relaxed Fit Tapered Leg Jeans

15-oz. 100% cotton denim is prewashed for a broken-in feel. Relaxed fit provides more room in the seat and legs for better range of motion while working. 15.25" tapered leg opening. Plain front with traditional front and rear pockets. Stonewash. B17.

Item #	Waist Size	Inseam	Price
95W	28"-44"	30"-38"	\$34.99
95W	46"-54"	30"-32"	\$39.99



carhartt Traditional Fit Straight Leg Jeans

Prewashed for comfort the first time you put them on. Made of durable, 15-oz., 100% cotton denim, they sit slightly below the waist and feature a slim seat and thigh. Two reinforced back pockets. 17.5" leg openings fit over most work boots. Deepstone. B480.

Item #	Waist Size	Inseam	Price
214153	31"-42"	32"-36"	\$29.99



NEW

carhartt Rugged Flex® Rigby Dungarees

Midweight pants that offer a full range of motion

When your daily routine keeps you on the move, these pants offer a relaxed fit that maintains an unrestricted range of motion to work on your to-do list. Cotton canvas material offers the perfect amount of stretch for easy movement. They've got all the traditional jean pockets plus a secure thigh pocket for your phone or trusty knife. Constructed of 8-oz. 98% cotton/2% spandex. Specify color.

Item #	Waist Size	Inseam	Price	
102291	30"-42"	30"-32"	\$44.99	Gravel
				Dark Khaki



NEW

carhartt Rugged Flex® Rigby Double-Front Pants

When the job keeps you on your knees, these purpose-built pants feature the added durability of a double-front design and the convenience of knee pad compatibility. Midweight canvas blend offers the perfect amount of stretch for easy movement. All the traditional jean pockets plus a secure right thigh phone pocket and a left thigh utility pocket. Constructed of 8-oz. 98% cotton/2% spandex canvas. Specify color.

Item #	Waist Size	Inseam	Price	
102802	30"-42"	30"-32"	\$49.99	Shadow
				Hickory



NEW

carhartt Rugged Flex® Rigby Knit-Lined Dungarees

These rugged pants give you the range of motion you need when climbing ladders, crawling through brush, or working under the car. Made with cold weather in mind, they have a canvas construction lined with warm fleece. Large pocket on the leg gives you a place to stash your phone. Specify color.

Item #	Waist Size	Inseam	Price	
231113	30"-44"	30"-36"	\$41.24	Gravel
231113	46"	30"-32"	\$44.99	Dark Khaki



carhartt Rugged Flex® Rigby Cargo Pants

Carhartt does it again! Rugged Flex stretch technology creates the most comfortable, easy-moving cargo pants ever. Midweight 98% cotton/2% spandex canvas stands up to the toughest jobs, yet won't weigh you down. Extra room through the seat and thigh. Side, back and cargo pockets, including secure storage for your phone. Specify color.

Item #	Waist Size	Inseam	Price	
103574	30"-44"	30"-36"	\$44.99	Dark Khaki
				Shadow
				Khaki



carhartt Rugged Flex® Rigby Five-Pocket Pants

Made from a tough, stretchable material that keeps you movin’

These pants give you the flexibility to work without tightness and restriction. 8-oz., 98% cotton, 2% spandex canvas sits at the waist, with a relaxed seat and thigh. Strong, sewn-on-the-seam belt loops. Straight leg opening. Carhartt 102517. Specify color.

Item #	Waist Size	Inseam	Price	
228728	30"-44"	30"-36"	\$44.99	<div style="display: flex; gap: 5px;"> <div style="width: 15px; height: 15px; background-color: #444; border: 1px solid #000;"></div> Gravel <div style="width: 15px; height: 15px; background-color: #8B4513; border: 1px solid #000;"></div> Hickory </div>



carhartt Canvas Work Dungarees

Constructed of 7.5-oz., 100% cotton canvas fabric that is prewashed so they're comfortable from the first wear. Left leg hammer loop and ruler pocket, right leg has a handy pocket for a cell phone or tools. Reinforced belt loops and a utility loop on the right side seam for securely storing your tape measure. B151. Specify color.

Item #	Waist Size	Inseam	Price	
G20151	30"-38"	30"-36"	\$39.99	<div style="display: flex; gap: 5px;"> <div style="width: 15px; height: 15px; background-color: #A0522D; border: 1px solid #000;"></div> Light Brown <div style="width: 15px; height: 15px; background-color: #C98033; border: 1px solid #000;"></div> Tan <div style="width: 15px; height: 15px; background-color: #8B4513; border: 1px solid #000;"></div> Dark Khaki <div style="width: 15px; height: 15px; background-color: #333; border: 1px solid #000;"></div> Fatigue </div>



carhartt Rugged Khaki Work Pants

Unlike traditional khakis, these work trousers are made from 9.25-oz., 100% cotton ringspun peached twill for durability. Pants sit comfortably at the waist, with a relaxed seat and thigh. Strong sewn-on-the-seam belt loops. Cell phone pocket on right leg and two back welt pockets. Straight leg opening. Carhartt 100095. Specify color.

Item #	Waist Size	Inseam	Price	
225708	30"-44"	30"-36"	\$39.99	<div style="display: flex; gap: 5px;"> <div style="width: 15px; height: 15px; background-color: #8B4513; border: 1px solid #000;"></div> Dark Khaki <div style="width: 15px; height: 15px; background-color: #A0522D; border: 1px solid #000;"></div> Field Khaki </div>



carhartt Relaxed Fit Washed Twill Dungarees

9.25-oz., 100% ringspun cotton twill fabric looks and feels great, but doesn't shy away from hard work. Ringspun cotton is softer and more durable than traditional cotton fibers. Left-side hammer loop, right-side tool and utility pockets, reinforced back pockets. 19" leg opening. B324. Specify color.

Item #	Waist Size	Inseam	Price	
163288	30"-31"	30"-32"	\$23.00	<div style="width: 15px; height: 15px; background-color: #6B8E23; border: 1px solid #000;"></div> Army Green
163288	30"-44"	30"-34"	\$39.99	<div style="display: flex; gap: 5px;"> <div style="width: 15px; height: 15px; background-color: #333; border: 1px solid #000;"></div> Black <div style="width: 15px; height: 15px; background-color: #8B4513; border: 1px solid #000;"></div> Dark Khaki <div style="width: 15px; height: 15px; background-color: #A0522D; border: 1px solid #000;"></div> Field Khaki </div>



Ranger Ripstop Cargo Pants

Roomy cargo pockets for carrying your tools

10-oz., 100% cotton ripstop fabric stands up to the most grueling work conditions without weighing you down. Reinforced knees with bottom vent and roomy bellowed-style cargo pockets. The room-2-move™ relaxed fit provides a better fit throughout the seat, thigh and knee. Specify color.

Item #	Waist Size	Inseam	Price
145855	30"-42"	30"-36"	\$46.99
145855	44"-52"	30"-36"	\$49.99



Relaxed Fit Prewashed Jeans

Easy-entry, extra-deep front pockets

Added room in the seat, thighs and knees so you will never feel restricted while working. Wide leg openings make them fit comfortably over your work boots. Constructed of durable 14.5-oz., 100% cotton denim. Extra-deep front pockets with right front coin pocket and two rear pockets. 16.5" leg opening. Vintage indigo.

Item #	Waist Size	Inseam	Price
20351	28"-42"	30"-36"	\$34.99
20351	44"-54"	30"-36"	\$38.99



Relaxed Fit Room2Move™ Jeans

Feature a motion fit that has more room in the seat, thigh, knee and bottom so you won't be constrained by your jeans. 14.5-oz. 100% cotton denim is treated with durashield™ to retain its color and durability wash after wash. Back pockets are lined with 1,000-denier Cordura®; right front pocket is reinforced with leather so your tape measure won't wear it out. Features a right-side hammer loop and a gusseted crotch. Antique indigo.

Item #	Waist Size	Inseam	Price
G29138	32"-42"	30"-34"	\$39.99
G29138	44"-52"	30"-34"	\$44.99



Technician Pants

You'll feel a difference as soon as you slip them on. Lightweight, yet tough, 7-oz. 100% ripstop cotton with a Room2Move™ fit that gives you extra room in the seat and thighs. Action crotch gusset lets you crouch and bend without constriction. Right-side cell phone pocket and leather tape measure reinforcement. Triple-stitched seams. Extra-deep front and rear pockets. Specify color.

Item #	Waist Size	Inseam	Price	
231220	30"-44"	30"-34"	\$39.99	<div style="display: flex; flex-direction: column; gap: 5px;"> <div> Loden/ Dark Green</div> <div> Charcoal</div> <div> Dark Khaki</div> </div>



Columbia Silver Ridge™ Convertible Pants

From pants to shorts in a zip!

Columbia makes these Silver Ridge convertible pants especially for hiking, rafting and kayaking, but we think they're great for work, too. When you get too hot on the job, just a quick zip, zip and you've got a pair of shorts with a 10" inseam. Tough ripstop nylon wicks away sweat (Omni-Wick™ technology) and blocks harmful rays with UPF 50 protection. Partial elastic waist, three pockets (one zips closed) and easy-moving fit. Specify color.

Item #	Waist Size	Inseam	Price	
231076	30"-44"	30"-34"	\$60.00	<input type="checkbox"/> Tusk <input type="checkbox"/> Gravel



Columbia Women's Saturday Trail™ II Stretch Convertible Pants

From pants to shorts in a zip!

Columbia Women's Convertible Stretch Pants are made especially for hiking, rafting and kayaking, but we think they're great for work, too. When you get too hot on the job, just a quick zip, zip and you've got a pair of shorts with a 10" inseam. 96% nylon/4% elastane wicks away sweat and blocks harmful rays with UPF 50 protection. Partial elastic waist, zip security pocket and articulated knees for freedom of movement. Women's even size 2-16.

NOTE: Columbia's sizing chart shows the following information. Size XS/2 (waist 25.5-26.5, hips 34.5-35.5), S/4-6 (waist 27.5-28.5, hips 36.5-37.5), M/8-10 (waist 29.5-30.5, hips 38.5-40), L/12-14 (waist 32-33.5, hips 41.5-43), XL/16-18 (waist 35.5-37.5, hips 45-47).

Item #	Size	Price	
9231085	2-16	\$65.00	<input type="checkbox"/> Tan <input type="checkbox"/> Black



Performance Comfort 5-Pocket Jeans

These blue jeans are rugged and hold up to tough jobsites. 12-oz. cotton denim blend is long lasting. Comfortable relaxed fit gives you plenty of room to bend, crouch and work. Feature an antique brass button waistband and contrast stitching. Indigo blue.

Item #	Waist Size	Inseam	Price
225569	30"-44"	32"-36"	\$21.99



Columbia Silver Ridge™ Cargos Shorts

The coolest cargo shorts you've ever worn

In lightweight ripstop nylon, you'll barely notice you have these shorts on. They wick away sweat when you're working or playing hard using Omni-Wick™ technology. UPF 50 sun protection keeps you safer on hot, sunny days. Side-elastic waist for easy-moving comfort, plus three pockets (one zips closed). 10" inseam. Specify color.

Item #	Waist Size	Price	
231075	30"-42"	\$45.00	<input type="checkbox"/> Boulder <input type="checkbox"/> Fossil



Carhartt Rugged Flex® Rigby Shorts

No matter your job, these shorts provide the freedom of movement you need. 8-oz., 98% cotton/2% spandex canvas sits at the waist, plus has a relaxed seat and thigh. Front slash pockets are reinforced for added strength. Durable, sewn-on-the-seam belt loops. Right-leg cell phone pocket. 10" inseam. Carhartt 102514. Specify color.

Item #	Waist Size	Price	
228733	30"-44"	\$29.99	Gravel
			Hickory
			Tan



Carhartt Force Extremes™ Cargos

Innovative material helps maintain your ideal body temperature

FastDry® with 37.5° technology accelerates the drying process, adding comfort to your workday. Feature Rugged Flex® stretch technology, plus a relaxed seat/thigh and gusseted crotch. 6-oz., 53% cotton, 25% polyester, 22% Cocona® 37.5 polyester. 10" inseam. Carhartt 101973. Specify color.

Item #	Waist Size	Price	
228730	32"-44"	\$49.99	Dark Khaki
			Shadow



Carhartt Rugged Flex® Rigby Cargos

Squat, stretch, do the boogaloo in Rugged Flex cargo shorts

These shorts feel so good, you might feel like dancing, thanks to Carhartt's Rugged Flex stretch technology. 98% cotton/2% spandex canvas, with work-worthy 11" length, extra ease through the seat and thigh, all the handy pockets you need. Left leg cargo pocket with cell phone compartment, right leg cargo pocket with utility pocket. Specify color.

Item #	Waist Size	Price	
103542	30"-44"	\$26.24	Dark Khaki
103542	46"	\$29.99	Tan
103542	30"-44"	\$34.99	Tarmac
103542	46"	\$39.99	Shadow



Ranger Shorts

Stand up to grueling work conditions

Constructed of 10-oz. cotton, military-style ripstop fabric for durability and long wear. A roomier fit through the seat, thigh and knee area, plus a gusseted crotch. Bellowed-style cargo pockets, hammer loop and leather-reinforced tape measure pocket on right side with Cordura®-lined back pockets and wider front pockets. 10.5" inseam. Specify color.

Item #	Waist Size	Price	
211641	30"-44"	\$36.99	Black
			Navy
			Slate



carhartt Duck Bib Overalls

Carhartt took their most popular unlined bib overalls and made them even better with suggestions from the hardworking Carhartt crew. Now, there's extra stretch around the waist, front-to-back kick panels on the cuffs, and many more improvements that make these the best bibs you'll ever work in. 12-oz., 100% ringspun cotton duck with adjustable elastic suspenders, double-layer knees and triple-stitched seams. Multi-compartment bib pocket with zip closure, large front ledge pockets, reinforced back pockets, right leg hammer loop. Specify color.

Item #	Waist Size	Inseam	Price
102776	32"-44"	28"-36"	\$79.99
102776	46"-54"	28"-36"	\$89.99



carhartt Washed Denim Bib Overalls

11.75-oz., 100% cotton denim bibs are washed to a soft, slightly faded texture that feels like an old favorite from the start. Adjustable, high-back suspenders won't slide off your shoulders. Also feature a large bib pocket, watch pocket, right front coin pocket, two quarter top pockets at waist, right leg tool pocket and left leg hammer loop. Zipper fly. Darkstone. R07.

Item #	Waist Size	Inseam	Price
SW566	28"-44"	28"-36"	\$59.99
SW566	46"-54"	28"-34"	\$64.99



PERSONALIZE

carhartt Sandstone Duck Bib Overalls

These bibs are very comfortable and need no breaking in thanks to a unique factory prewash process. Made of the same rugged 12-oz., 100% cotton duck famous in Carhartt outerwear. Double knees have cleanout bottoms and accommodate knee pads. Zipper fly and adjustable waist. Reinforced rear pockets, right leg tool pockets, left leg hammer loop and ruler pocket. R06. Specify color.

Item #	Waist Size	Inseam	Price	
G21016	30"-42"	30"-36"	\$52.50	Dark Brown
G21016	44"-50"	30"-34"	\$59.99	Brown



carhartt Women's Crawford® Double-Front Bibs

These bib overalls give you plenty of room to bend and crouch. Double-front, 8-oz., 98% cotton/2% spandex with Rugged Flex® technology and triple-stitched seams. Zippered multi-compartment bib pocket, two lower-front pockets, plus multiple utility pockets and a hammer loop. Carhartt 102438. Specify color.

Item #	Inseam	Size	Price	
228740	30"-32"	XS-2XL	\$69.99	Dark Brown
				Brown



carhartt **Quilt-Lined Cotton Duck Bibs**

Ankle-to-thigh leg zips with storm flaps

12-oz., 100% ringspun cotton duck bib has a midweight polyester lining from the waist down. Chap-style, double-front panels and Cordura® kick panels for greater durability and wear. Zipper fly. Specify color.

Item #	Waist Size	Inseam	Price	
156349	46"-50"	28"-34"	\$109.99	Black
156349	30"-44"	28"-36"	\$99.99	Brown



carhartt **Arctic Cotton Duck Bibs**

Quilted arctic lining for the coldest conditions

Constructed of durable 12-oz., 100% ringspun cotton duck for long wear. Feature a heavy arctic lining to keep you warm when the temperature plummets. Carhartt's warmest lining option. Ankle-to-knee leg zippers. Double-layer knees that accommodate knee pads. R03. Specify color.

Item #	Waist Size	Inseam	Price	
21185	46"-50"	28"-34"	\$109.99	Black
21185	32"-44"	28"-36"	\$99.99	Brown



PERSONALIZE

carhartt **Yukon Extremes® Zip-Front Bibs**

Stay warm and dry in the coldest weather

Made of 1000-denier Cordura® nylon that's guaranteed to wear 10 times longer than cotton duck. Warm and water-resistant bib overalls are loaded with features, including leg zippers that open to the waist for easy on/off, double-layer knees, rear patch pockets, two zippered chest pockets, hammer loop and side tool pockets. R33.

Item #	Waist Size	Inseam	Price
20033	46"-50"	28"-34"	\$108.74
20033	32"-44"	28"-36"	\$97.49



PERSONALIZE

carhartt **Zip-Front Quilt-Lined Duck Bibs**

Full-length chest and leg zippers

These 12-oz. cotton duck bibs have a midweight red quilt lining from chest to cuff - giving you added warmth on cold days. Plus, the chest zipper features a wind flap and snap closures at waistband and top of bib to help keep cold, drafty air out. Adjustable elastic suspenders and plenty of pockets. R38. Specify color.

Item #	Waist Size	Inseam	Price	
125627	32"-44"	28"-34"	\$119.99	Black
125627	46"-50"	28"-34"	\$129.99	Brown



PERSONALIZE

carhartt Women's Full Swing® Cryder Bibs

Suspender back and side zippers let you use the restroom without undressing

Soft, yet durable 8.5-oz., cotton/poly/spandex blend shell with warm 60g quilted 3M™ Thinsulate™ insulation. Rain Defender® water repellent keeps you dry. Double knees that can fit kneepads. Adjustable leg openings accommodate boots. Carhartt 102740.

Item #	Inseam	Size	Price
230820	30"-34"	XS-2XL	\$149.99



PERSONALIZE

carhartt Women's Wildwood Insulated Bibs

Insulated for warmth and reinforced in all the right places

Full-featured bibs designed to fit hard-working women. 12-oz., 100% cotton duck with warm 100% nylon quilted lining. Double-front knees with cleanout bottoms to accommodate knee pads. Ankle-to-hip leg openings have storm flaps and adjustable cuffs to make it easy to put on boots. Carhartt 102743. Specify color.

Item #	Inseam	Size	Price	
230819	29"-33"	XS-2XL	\$109.99	<input type="checkbox"/> Black <input type="checkbox"/> Dark Brown



Prewashed Denim Bib Overalls

These deep blue garment-washed bibs are constructed of a heavy-duty, 11.75-oz., 100% cotton denim. Triple-stitching and bar-tacks on critical stress points for unsurpassed wear. The rugged shoulder straps adjust for a perfect fit. Keys, tools or other valuables have a place in the deep front pockets, right-side tool pocket or numerous front chest pockets. Zipper fly front.

Item #	Waist Size	Inseam	Price
148063	30"-50"	30"-34"	\$44.99



Hickory-Stripe Denim Bib Overalls

Made of unwashed 11.5-oz., 100% firm cotton denim with triple-needle stitching and bar-tacked stress points for greater durability and longer life. Feature double oversized bib pockets with right-side button closure, adjustable shoulder straps, zipper fly and left-side hammer loop. Right-side utility pockets, oversized rear pockets and the deep front pockets offer plenty of storage for your tools, change, phone or whatever you need to carry.

Item #	Waist Size	Inseam	Price
148062	30"-50"	30"-34"	\$44.99



PERSONALIZE

Carhartt Yukon Extremes® Arctic-Lined Coveralls

The warmest, strongest, most durable coveralls Carhartt makes. 1,000-denier Cordura® nylon has excellent abrasion, tear and puncture resistance. Quilted arctic-grade lining keeps you warm in the harshest weather. Water-resistant coveralls have rear patch pockets, front waist and chest pockets, hammer loop and side tool pockets. Two-way covered leg zippers open to the waist for easy on/easy off. X06.

Item #	Size	Price
G26266	34-58 Reg, 40-54 Short	\$127.49
G26266	34-58 Reg, 40-54 Short	\$142.49
G26266	38-54 Tall	\$142.49



PERSONALIZE

Carhartt Women's Wildwood Insulated Coveralls

Insulated for warmth and reinforced in all the right places

Full-featured coveralls designed to fit hard-working women. 12-oz., 100% cotton duck with 100% nylon quilted lining. Ankle-to-hip leg openings have storm flaps and adjustable cuffs making it easy to put on boots. Multiple utility pockets and a hammer. Carhartt 103382.

Item #	Size	Price
230818	XS-L	\$112.49



PERSONALIZE

KEY Zip-to-the-Knee Unlined Coveralls

Zip to the knees for easier on/off

These coveralls have a two-way, full-zippered front with a snap-down storm flap. 8.5-oz., 55% cotton/45% polyester blend. Short fits 5'4"-5'7"; Regular fits 5'8"-5'11"; Tall fits 6'0"-6'3". Specify color.

NOTE: Short length is not available in 3XL-4XL.

Item #	Size	Price	
156311	MS-4XL Reg., MT-4XLT Tall	\$54.99	<input type="checkbox"/> Fisher <input type="checkbox"/> Stripe <input checked="" type="checkbox"/> Navy



PERSONALIZE

KEY Short-Sleeve Unlined Poplin Coveralls

Rugged, with a stain- and water-repellent finish so you can maintain a professional look, even after hours of dirty work. Full, relaxed fit and pleated back make it easy to move around comfortably. Two oversized reinforced rear pockets, two snap-close exterior chest pockets and two side utility pockets. 5.25-oz., 55% cotton/45% polyester poplin. Specify color.

NOTE: It is recommended that you order one size larger to accommodate clothing under this coverall.

Item #	Size	Price	
198352	M-2XL Reg., MT-2XLT Tall	\$36.99	<input checked="" type="checkbox"/> Navy <input type="checkbox"/> Tan



Long-Sleeve Poly/Cotton Twill Coveralls

Cool-wearing, stain-resistant coveralls are excellent for shop work, outdoor crews and any job where you need extra protection from dirt, splashes or spills. Eight pockets—two on the chest (left side has pencil pocket), two set-in hip pockets, two tool pockets on the right side and two deep back pockets. Side vent openings allow access to inside pants pockets. Two-way brass zipper front. 7.5-oz., 65% polyester/35% cotton blend. Specify color.

Item #	Price
G20010	\$49.99



Short-Sleeve Poplin Coveralls

Stay cool and clean even on hot summer days

Lightweight coveralls are constructed of a 65% polyester/35% cotton blend. Bi-swing action back allows greater freedom of movement. Soil-release fabric wards off stains. Two chest pockets, two set-in hip pockets and two deep back pockets. Two-way brass zipper front.

Item #	Size	Price
21040	S-XL Reg.	\$42.99
21040	2XL-3XL Reg., LT-2XLT Tall	\$47.99



Long-Sleeve Cotton Coveralls

Oversized 100% cotton coveralls make sure you have the flexibility and range of movement necessary. Side vent openings allow easy access inside pants pockets. Wide leg openings easily fit over your work boots. Specify color.

Item #	Size	Price	
G22014	M-3XL Reg., MT-2XLT Tall	\$59.99	Blue
			Fisher Stripe
			Navy



Basic Long-Sleeve Coveralls

Keep dirt and grime off your clothing

Maintain a professional appearance while working a variety of dirty jobs. Durable 7.5-oz., 65% polyester/35% cotton coveralls feature a stain-release finish for longer wear, plus a bi-swing back for better freedom of movement. Elastic at the waist for a better fit. Include handy ruler pocket, two large back pockets and concealed neck and waist snap. Brass two-way zipper.

Item #	Size	Price
219004	S-2XL Reg.	\$42.99
219004	3XL-4XL Reg., MT-4XLT Tall	\$46.99



NEW

Carhartt Base Force® Heavyweight Poly-Wool Base Layer

Temperature-regulating 6.5-oz., 80% polyester/20% wool blend to keep you warm, dry and odor free on the coldest days. Rugged Flex® fabric moves with you. FastDry® technology wicks away sweat. Specify color.

Item #	Size	Description	Price	
MBL121	S-2XL Reg.	Bottom	\$44.99	Black Heather
MBL120	S-2XL Reg.	Shirt	\$49.99	Navy Heather
MBL121	3XL-4XL Reg., LT-3XLT Tall	Bottom	\$55.99	
MBL120	3XL-4XL Reg., LT-3XLT Tall	Shirt	\$61.99	



NEW

Carhartt Base Force® Heavyweight Thermal Base Layer

7.7-oz., 95% polyester/5% spandex, this base layer works as hard as you do to keep you warm, dry and odor free on the coldest days. Rugged Flex® fabric moves with you. FastDry® technology wicks away sweat. Specify color.

Item #	Size	Description	Price	
MBL112	S-2XL Reg.	Bottom	\$44.99	Navy Heather
MBL111	S-2XL Reg.	Shirt	\$49.99	Shadow
MBL112	3XL-4XL Reg., LT-3XLT Tall	Bottom	\$55.99	
MBL111	3XL-4XL Reg., LT-3XLT Tall	Shirt	\$61.99	



NEW

Carhartt Base Force® Midweight Thermal Base Layer

Features classic 6-oz. polyester waffle-knit fabric that traps your body's heat on those cold days. Rugged Flex® fabric moves with you and FastDry® technology wicks away sweat. **Crewneck Shirt** - Concealed thumb loops keep your sleeves in place. **Bottom** - Y-Split elastic waistband with concealed stitching and contoured front for comfort. Specify color.

Item #	Size	Description	Price	
MBL113	S-2XL Reg.	Shirt	\$29.99	Black
MBL115	S-2XL Reg.	Bottom	\$29.99	Navy
MBL115	3XL-4XL Reg., LT-3XLT Tall	Bottom	\$39.99	Shadow
MBL113	3XL-4XL Reg., LT-3XLT Tall	Shirt	\$39.99	



NEW



Men's Packaged Base 3.0

78% polyester/22% elastereil knit has a brushed grid interior that traps sweat without the bulk. Four-way stretch material for super mobility and sweat-wicking technology keeps you dry when you're active. Scent control.

Item #	Description	Size	Price
231131	Shirt	S-3XL	\$70.00
231132	Bottom	S-3XL	\$70.00



NEW



Women's Base Layer

This women's base layer is constructed of 78% polyester/22% elastereil knit and has a brushed grid interior that traps sweat without the bulk. Four-way stretch material for super mobility. Sweat-wicking technology keeps you dry when you're active. Scent control.

Item #	Description	Size	Price
231133	Shirt	S-XL	\$70.00
231134	Bottom	S-XL	\$70.00

Footwear

The first thing anyone who works outdoors needs is a good pair of boots. Call us at 1-800-882-8473 and we'll help you get the right pair. Plus, we're your best source for leather and rubber/pvc boots - shop Carhartt®, Timberland Pro®, Muck® Boots and more!

NEW

Muck® Boots Edgewater Classic Hi Vis Boots
231232 on pg. 478



Timberland Pro® Men's Powertrain Low-Height Work Shoes
A1B6S on pg. 463



Keen Utility® Pittsburgh Series Plain Toe Waterproof Boots
219028 on pg. 472



Gempler's® 16"H Brown Bear™ PVC Boots
139026 on pg. 480

GEMPLER'S®



UTILITY

TOP BRANDS

carhartt



WOLVERINE

LACROSSE®

Boots & Shoes..... 462-485
Waders..... 486

Socks487-490
Accessories491-494

NEW**Drivetrain Composite Toe Mid Boots**

Low-profile, lightweight-yet-tough ripstop nylon upper and a composite safety toe. TPU soles are slip, oil and heat resistant up to 248°F. Resilient anti-fatigue footbeds with dynamic arches and open-cell polyurethane covers for moisture management. Meets ASTM standards. Specify Men's size: Medium and Wide widths in whole and half sizes 7-15 (no half sizes 12-15).

Item #	Price
A1X16	\$134.95

**Classic Wheat Boots**

Waterproof full-grain nubuck leather, latex-sealed seams, proven direct-attach construction, 200g Thermolite® insulation and Timberland PRO Series comfort technology come together in these outstanding work boots. Removable cushioned sock liner is contoured for greater comfort. Padded collar. Non-marking, slip-resistant lug outsole. Steel toe meets ASTM standards. Specify Men's size: Medium (D) or Wide (EE) width and Size.

Item #	Size Range	Toe Type	Height	Price
109758	7-15	Plain	6"	\$139.95
109757	7-15	Steel	6"	\$144.95

**Titan® Work Boots and Oxford Shoes**

Resilient cushioning and high-rebound heel make them extra comfortable for all-day wear. Footbed regulates temperature. Rubber outsole resists slipping, oils and abrasions and provides electrical hazard protection. Alloy toe meets ASTM standards. Specify Men's Size and Width Medium (D) or Wide (EE).

Item #	Size Range	Toe Type	Height	Price
134430	7-15	Alloy	4"	\$119.95
125724	7-15	Alloy	6"	\$129.95
145860	7-15	Alloy	8"	\$159.95





Powertrain Low-Height Work Shoes

Work in the same kind of lightweight, cushioned comfort you enjoy in your athletic shoes. Ripstop nylon uppers, polyurethane midsoles for electrical hazard resistance, polyurethane soles that are oil, abrasion and heat resistant to 248°F. Anti-fatigue technology. Meet ASTM standards. Specify Men's Size and Width, Medium or Wide.

Item #	Size Range	Color	Toe Type	Height	Price	
A1B6S	7-15	Orange	Alloy	5"	\$99.95	Black/Orange
A1HRU	7-15	Blue	Alloy	5"	\$99.95	Black/Blue
A1I4S	7-15	Black	Alloy	5"	\$99.95	Black



Powertrain Mid-Height Work Shoes

Work in the same kind of lightweight, cushioned comfort you enjoy in your athletic shoes. Ripstop nylon uppers, polyurethane midsoles for electrical hazard resistance, polyurethane soles that are oil, abrasion and heat resistant to 248°F. Anti-fatigue technology. Meet ASTM standards. Specify Men's Size and Width: Medium or Wide.

Item #	Price
A1JYQ	\$104.95



NEW



Drivetrain Composite Toe Work Shoes

Low-profile, lightweight-yet-tough ripstop nylon upper and a composite safety toe. TPU soles are slip, oil and heat resistant up to 248°F. Anti-fatigue footbeds and open-cell polyurethane covers for moisture management. Meets ASTM standards. Specify Men's Size and Width: Medium or Wide.

Item #	Price
A1XH7	\$99.95



Athletic-Style Steel Toe Shoes

Aggressively designed Mudsill safety toe work shoes have all the details of an industrial boot. The 24/7 system disperses the shock felt by your heels and legs and the overall pressure applied to your feet. Leather and fabric uppers are abrasion resistant and breathable. Elastic pulls on the heel and tongue for easy on/off. Removable antimicrobial cushioned insole. Meets ASTM standards. Specify Men's size: Medium (D) or Wide (EE) width in whole and half sizes 7-15 (no half sizes 12-15).

Item #	Price
134431	\$115.99



Pit Boss Work Boots

Oiled full-grain leather upper with 24/7™ comfort system that provides unparalleled support and cushioning. Slip-, oil- and abrasion-resistant rubber sole. Steel toe version features a much roomier toe box than most other boots for a less-restrictive fit. Features electrical-hazard protection to provide protection from open circuits. Goodyear welt allows you to resole these boots. Steel toe meets ASTM standards. Specify Men's size: Medium (D) or Wide (EE) width in whole and half sizes 8–14 (no half sizes 12–14).

Item #	Size Range	Toe Type	Height	Price
G33046	8-14	Plain	6"	\$125.00
G33034	8-14	Steel	6"	\$130.00



Helix 9.5\"/>

Cement construction for flexibility and reduced break-in time. Anti-fatigue midsole absorbs shock as you walk, keeping you comfortable during long days on your feet. Unique "fingerrip" pull-on feature for easy on/off. Mesh lining with antimicrobial treatment controls odor. Nylon shank offers structural support. Meets ASTM standards. Specify Men's size: Medium (D) or Wide (EE) width in whole and half sizes 7–14 (no half sizes 12–14).

Item #	Price
214331	\$218.00



PowerWelt 6\"/>

Specially impregnated Ever-Guard™ leather is extremely abrasion resistant and withstands temperatures up to 248°F. Constructed with premium full-grain waterproof leather and a durable membrane that allows your feet to breathe. Goodyear welt construction and a lightweight polyurethane outsole. Temperature regulating and antimicrobial footbed provides all-day comfort while on the job. Unique Ladder Lock™ outsole design and internal steel shank prevents arch fatigue when standing on extension ladders. Meets ASTM standards. Specify Men's size: Medium (D) or Wide (EE) width in whole and half sizes 7–14 (no half sizes 12–14).

Item #	Price
139241	\$173.50



Endurance 6\"/>

Anti-Fatigue Technology features thick polyurethane midsoles that act like shock absorbers for your feet and provide that spring in your step for all-day comfort. Rugged full-leather uppers, rubber backstays and abrasion-resistant double toes extend the life of the boot. Flexible Steel-Flex® puncture-resistant plate gives your feet unparalleled protection on the jobsite. Slip- and oil-resistant rubber outsole. Fiberglass shank. Meets ASTM standards. Specify Men's size: Medium (D) or Wide (EE) width in whole and half sizes 7–15 (no half sizes 12–15).

Item #	Size Range	Waterproof	Toe Type	Height	Price
167487	7.5-15	No	Steel	6"	\$149.95
224273	7-15	Yes	Steel	6"	\$169.95



Women's Hightower Work Boots



Supple full-grain leather uppers with anti-fatigue footbeds make for a kind of comfort you may never have experienced. The leather itself is waterproof, and has a waterproof membrane that locks out water and bloodborne pathogens. Antimicrobial for odor control. TPU outsoles are slip, oil and heat resistant to 248°F. Alloy toe meets ASTM standards. Specify Women's size: Medium width in whole sizes 6-12.

Item #	Size Range	Toe Type	Price
A1RUJ	6-12	Plain	\$134.95
A1KIT	6-12	Alloy	\$139.95



Women's Powertrain Sport Work Shoes

As lightweight and comfortable as they look, yet plenty tough, and packed with high-performance features. Ripstop nylon uppers, with polyurethane outsoles that resist oil, abrasion and heat to 248°F. Footbeds mold to your feet for a custom fit and feel. Alloy safety toes for lightweight protection. Meets ASTM standards. Specify Women's size: Medium and Wide widths in whole sizes 6-11.

Item #	Size Range	Color	Toe Type	Height	Price	
A1H1S	6-11	Purple	Alloy	5"	\$99.95	 Black/Purple
A1I54	6-11	Blue	Alloy	5"	\$99.95	 Black/Blue



Women's Direct Attach Work Boots

Timberland has designed these especially for women! Features include: seam-sealed waterproof leather uppers, 200 grams of Thermolite® insulation, rubber lug outsoles that resist oil and slipping. Antimicrobial for odor control. Perfect for work outdoors in a cold climates. Steel toe meets ASTM standards. Specify Women's size: Medium width in whole sizes 6-12.

Item #	Size Range	Toe Type	Height	Price
A1RWC	6-12	Plain		\$124.95
A1KJ8	6-12	Steel	6"	\$134.95



NEW



Women's Drivetrain Composite Toe Work Shoes

Low-profile, lightweight-yet-tough ripstop nylon upper is a refreshing change from stiff, heavy work boots. TPU soles are slip, oil and heat resistant up to 248°F. Anti-fatigue footbeds with dynamic arches and open-cell polyurethane covers for moisture management. Meets ASTM standards. Specify Women's size: Medium width in whole and half sizes 5.5-12 (no half sizes 10-12).

Item #	Price
A1XJE	\$99.95



Carhartt **Bison Work Boots**

Oil-tanned brown leather upper with a 100% waterproof membrane for superior dryness and comfort. Cushioned polyurethane insole absorbs shock. Feature direct-attach welt construction and a dual-density polyurethane outsole for added durability. Molded heel guard with Achilles flex joint for impact resistance and a natural range of motion. Steel toe meets ASTM standards. Specify Men's size: Medium (D) width in whole and half sizes 8–13 (no half sizes 12–13) or Wide (EE) width in whole and half sizes 8–15 (no half sizes 12–15).

Item #	Size Range	Toe Type	Height	Price
211723	8-14	Plain	6"	\$154.99
211777	8-14	Steel	6"	\$159.99
211729	8-15	Plain	8"	\$164.99
211778	8-15	Steel	8"	\$169.99



Carhartt **Force® Work Boots**

Coated leather with breathable, 3D-forming Ariaprene™ foam collar and tongue that's wear-resistant for continued performance. Storm Defender™ waterproof membrane keeps feet dry and comfortable. Dual-density high-performance EVA midsole is light and absorbs shocks. Fatigue- and odor-fighting insoles. Rubber outsole has medial and lateral traction tread. Meets ASTM standards. Specify Men's size: Medium (D) or Wide (EE) width in whole and half sizes 8–14 (no half sizes 12–14). NOTE: Plain toe available in medium sizes 11 and 14 only.

Item #	Size Range	Toe Type	Height	Price
224460	11-14	Plain	6"	\$144.99
224459	9-14	Composite	6"	\$149.99



Carhartt **Rugged Flex™ Work Boots**

Lightweight work boot that's built with comfort in mind. Five-layer sole-up comfort platform includes an EVA midsole with cushioned polyurethane insole for support and shock absorbance. Rubber outsole for durable traction and flexibility. Brown oil-tanned leather upper. Composite toe meets ASTM standards. Specify Men's size: Medium (D) width in whole and half sizes 8–14 (no half sizes 12–14) or Wide (EE) width in whole and half sizes 9–15 (no half sizes 12–15).

Item #	Size Range	Toe Type	Height	Price
218946	8-15	Plain	6"	\$124.99
218945	8-15	Composite	6"	\$129.99

**NEW****carhartt 4" Slip On Plain Toe Boot**

Feature a rugged, walled rubber outsole for all-surface traction. Waterproof, breathable membrane works with sweat-wicking, odor-fighting liner to keep your feet dry. Resilient cushioning dampens vibration and shock for day-long comfort. Meets ASTM F2892-11 EH standards. Specify Men's size: Medium (D) width in whole and half sizes 8-14 or Wide (EE) width in whole and half sizes 8-15.

Item #**CMS4100****Price****\$114.99****carhartt****Force® 4"H Composite Toe Slip-On Boots**

Comfortable, lightweight, black leather boots stay dry and cool inside. FastDry® lining and Storm Defender® waterproof/breathable membrane keep your feet dry. Dual-density EVA midsole with PU strobel pad cushions impacts and PU cushion insole fights odors. Rubber outsole is oil, chemical, abrasion, heat and slip resistant. Meets ASTM standards. Specify Men's size: Medium (D) or Wide (EE) width in whole and half sizes 8-13 (no half sizes 12-13).

Item #**225664****Price****\$129.99****NEW****carhartt****Lightweight Safety Toe Work Hikers**

These carbon nano toe hikers are easy on your feet. High-cut leather and nylon upper with waterproof/breathable membrane to keep feet dry. Footbed provides maximum arch support to reduce foot fatigue. FastDry® technology lining wicks away sweat. Rubber outsole. Meets ASTM standards. Specify Men's size: Medium (D) width in whole and half sizes 8-14 (no half sizes 12-14) or Wide (EE) width in whole and half sizes 8-15 (no half sizes 12-15).

Item #**CMH4480****Price****\$139.99****NEW****carhartt****Lightweight Safety Toe Work Shoes**

Low-cut work shoes have a waterproof/breathable membrane that keeps feet dry. Leather/nylon upper and rubber outsole. Footbed provides arch support to reduce foot fatigue. FastDry® technology lining wicks away sweat. Carbon nano toe meets ASTM standards. Specify Men's size: Medium (D) width in whole and half sizes 8-14 (no half sizes 12-14) or Wide (EE) width in whole and half sizes 8-15 (no half sizes 12-15).

Item #**CMO3481****Price****\$134.99**



Square Toe Wellington Boots

Roomy square toe wellingtons are constructed of dark bison brown oil-tanned leather and abrasion-resistant 1200D ballistic nylon. Moisture-wicking, breathable lining. Shallow tread design helps keep mud and dirt outside. Ladder lock-grips, with a reinforced shank and 90° heel to help during climbing jobs. Compression-molded EVA midsole for flexible comfort. Meets ASTM standards. Specify Men's size: Medium (D) or Wide (EE) width in whole and half sizes 8-14 (no half sizes 12-14).

Item #	Size Range	Toe Type	Height	Price
224458	8-14	Plain	11"	\$164.99
224457	8-14	Steel	11"	\$169.99



Wellingtons

Classic Wellington design is loaded with premium features. These waterproof Wellingtons are made of oil-tanned leather with an abrasion-resistant Cordura® upper shaft. Feature durable direct-attach welt construction and a dual-density polyurethane outsole for oil, chemical and slip resistance. Waterproof membrane. Meets ASTM standards. Specify Men's size: Medium (D) width in whole and half sizes 8-13 (no half sizes 12-13) or Wide (EE) width in whole and half sizes 8-14 (no half sizes 12-14).

Item #	Size Range	Toe Type	Height	Price
211779	8-14	Plain	11"	\$169.99
211780	8-14	Steel	11"	\$174.99



Ground Force 10"H Composite Toe Wellington Boots

Lightweight design helps maintain all-day comfort. Composite toe and heel reinforcements add impact resistance. Waterproof/breathable membrane works with the sweat-wicking liner to keep your feet dry. Resilient cushioning and enhanced arch support reduce foot fatigue. Meets ASTM standards. Specify Men's size: Medium (D) width in whole and half sizes 8-14 (no half sizes 12-14) or Wide (EE) width in whole and half sizes 8-15 (no half sizes 12-15).

Item #	Price
CME1355	\$169.99



carhartt **10"H Composite Toe Leather Pac Boots**

These cold-weather boots are insulated with 1,000g of LiteFire™ insulation, which gets sprayed onto the boot lining as a gas. When it dries, it's super-thin and equivalent to having 1,000g of heavyweight thermal insulation (Thinsulate™-type insulation without the bulk). Oil-tanned, PU-coated leather with heel, ankle and toe reinforcements. Waterproof/breathable membrane keeps feet dry. Foam cushioned insole with TPU arch support. Rubber outsole. Meets ASTM standards. Specify Men's whole and half sizes 9-14 (no half sizes 12-14).

Item #	Price
214235	\$199.99



NEW

carhartt **Lightweight Steel Toe Hikers**

These hiking boots cross the boundary between work and trail. No-sew nylon mesh/synthetic upper along with a rubber outsole provide lightweight comfort. FastDry® lining wicks sweat and fights odors. Footbed has maximum arch support to reduce foot fatigue. Cushioned polyurethane insole absorbs shock. Meets ASTM standards. Specify Men's size: Medium (D) width in whole and half sizes 8-14 (no half sizes 12-14) or Wide (EE) width in whole and half sizes 8-15 (no half sizes 12-15).

Item #	Price
CMH4251	\$109.99



carhartt **6"H Plain Toe Wedge Sole Boots**

Classic wedge design with a Goodyear welt and a dual-density rubber outsole, which is known for maximum comfort. Waterproof/breathable membrane keeps feet dry on the job. Thick insole offers extra support. FastDry® lining wicks sweat and fights odor. Brown oil-tanned leather upper. Meets ASTM F2892-17 EH standards. Specify Men's size: Medium (D) width in sizes 8.5-14 (no half sizes 12-14) or Wide (EE) width in sizes 9, 9.5, 10.5, 11, 11.5, 12, 15.

Item #	Price
218800	\$149.99



NEW

carhartt **4"H Plain Toe Wedge Chukka**

Work-quality boots for the jobsite or off the clock. Lace-up chukkas are made of premium oil-tanned leather with a sweat-wicking lining and a lightweight rubber outsole. Foam-cushioned polyurethane insole absorbs shock for all-day comfort. Specify Men's size: Medium (D) width in whole and half sizes 8-14 (no half sizes 12-14) or Wide (EE) width in whole and half sizes 8-15 (no half sizes 12-15).

Item #	Price
CMX4033	\$124.99

**NEW**

Outback 6"H Plain Toe Hikers

Chukka-style, moc-toe boots are constructed of full-grain leather with a Gore-Tex® lining for 100% waterproof/breathable protection. Deep-tread rubber outsoles provide superior traction on slick or rugged terrain. Terra suspension footbeds are perforated for better circulation. Specify Men's size: Medium or Wide widths in whole and half sizes 8-12 (no size 12.5).

Item #	Price
G8723	\$119.99

**NEW**

Legacy 32 6"H Plain Toe Boots

They have a great casual look, but are plenty tough enough for work, hunting, hiking, you name it. They deliver Rocky's driest experience, with Vapor Pass waterproof protection. Full-grain leather uppers, Vibram® outsoles, fiberglass shank, cushion midsole and footbed. Specify Men's size: Medium or Wide widths in whole and half sizes 8-12 (no size 12.5).

Item #	Price
RKS0431	\$139.99



FLXpoint Next 6"H Plain Toe Boots

Georgia FLXpoint Next boots have a dual-density polyurethane and rubber outsole that offers superior flexibility and cushioning while adding outstanding abrasion resistance. Waterproof system allows your feet to breathe and keeps them dry and comfortable—guaranteed. Full moisture-wicking liner, cushioned insole and padded collar. Specify Men's size: Medium (D) or Wide (EE) width in whole and half sizes 8-13 (no half sizes 12-13).

Item #	Price
167471	\$159.99



Lacer 8"H Plain Toe Boots

Lacer boots are 100% waterproof and guaranteed to keep your feet dry. Full-grain leather upper is great for working in the mud and slop around the barn, in the field or for running errands in town. No more tired and aching feet, thanks to the Rocky Ride comfort system. Eight-layer comfort system provides stability and extra cushioning. Speed lacing system, padded collar and steel shank. Specify Men's size: Medium (D) or Wide (EE) width in whole and half sizes 8-14 (no half sizes 12-14).

Item #	Price
211673	\$179.99

**NEW****WOLVERINE**  **Floorhand 6"H Steel Toe Boots**

Floorhand boots are built with surprising features like a waterproof full-grain leather upper, moisture-wicking mesh lining to keep feet cool and removable full-cushion footbed that molds to your foot. Rubber midsole, nylon shank and sure-gripping rubber outsole. Meets ASTM standards. Specify color: black, dark brown or wheat; and Men's size: Medium width in whole and half sizes 7.5-14 (no half sizes 12-14) or Extra Wide width in whole and half sizes 8-13 (no half sizes 12-13).

Item #	Price
W10633	\$94.95

**NEW****WOLVERINE**  **Rancher Steel Toe Wellingtons**

These souped-up Wellingtons are perfect for anyone who works outdoors. Stay dry with a 100% waterproof, premium full-grain leather upper. Other features include full-cushioned footbed, moisture-wicking lining and steel shank. Sure-gripping rubber and compression molded outsole. Meets ASTM standards. Specify Men's size: Medium and Extra Wide widths in whole and half sizes 8-13 (no half sizes 12-13).

Item #	Price
W10765	\$124.95

**WOLVERINE** **Buccaneer 6"H Plain Toe Work Boots**

Contour Welt™ delivers flexibility and comfort. Multishox™ rubber outsole has individual compression pads in the heel and foot to absorb impact. Full-grain leather upper and mesh lining that pulls perspiration away from your feet. Lightweight polyurethane midsole and removable comfort gel insole. Specify Men's size: Medium (D) or Extra wide (EEE) width in whole and half sizes 7-13 (no half sizes 12-13).

Item #	Price
160299	\$139.95

**NEW****WOLVERINE**  **I-90 6"H Composite Toe Boots**

The Wolverine I-90 is made for long hours and many miles. A highly abrasion resistant TPU outsole lasts 3x longer than other boots, and is resistant to splitting, chemicals and oils. BOA® Fit system allows for fast on/off, and a custom fit. Fatigue-fighting footbed, moisture-wicking mesh waterproof lining and nylon shank. Meets ASTM standards. Specify Men's size: Medium width in whole and half sizes 7-14 (no half sizes 12-14) or Extra Wide width in whole and half sizes 8-13 (no half sizes 12-13).

Item #	Price
W191063	\$159.95



Pittsburgh Series 6"H Waterproof Boots

Waterproof nubuck leather upper with a Keen.Dry waterproof/breathable membrane that lets moisture and sweat escape while keeping water out. Oil- and slip-resistant, non-marking rubber outsole that wraps up and over the toes for protection and abrasion resistance. Footbed provides excellent arch support and comfort. Steel toe meets ASTM standards. Specify Men's size: Medium (D) or Wide (EE) widths in whole and half sizes 8-15 (no half sizes 12-15).

Item #	Size Range	Toe Type	Height	Price
219028	8-15	Plain	6"	\$175.00
214341	8-15	Steel	6"	\$180.00



Mt. Vernon Steel Toe Work Boots

Features KEEN.Dry waterproof/breathable membrane, TPU shank for midfoot support, removable EVA footbed, locking metal lace hooks and a direct-attach PU midsole. Oil- and slip-resistant non-marking outsole, left and right asymmetrical steel toe. Meets ASTM standards. Specify Men's Size and Width: Medium (D) or Wide (EE).

Item #	Size Range	Toe Type	Price
225671	8-14	Steel	\$200.00
225672	8-15	Steel	\$210.00



NEW



San Jose 6"H Work Boots

Step into one of our lightest work boots yet. Air-infused, PU midsole provides weightless comfort. Unlined waterproof leather upper means no break-in period. Oil- and slip-resistant rubber outsole disperses liquids quickly for increased traction. TPU shank. Aluminum toe meets ASTM standards. Specify Men's size: Medium (D) or Wide (EE) widths in whole and half sizes 7-15 (no half sizes 12-15).

Item #	Size Range	Toe Type	Height	Price
1020146	7-15	Plain	6"	\$150.00
1020055	7-15	Aluminum	6"	\$155.00



Milwaukee Series 6"H Steel Toe Boots

Full-featured Milwaukee Series boots are built with a waterproof, full-grain leather upper, along with a Keen-Dry waterproof/breathable membrane to keep feet dry and comfortable. Oil- and slip-resistant rubber outsole. TPU stability shank. Left and right asymmetrical steel toe. Meets ASTM standards. Specify color: black or dark earth; and Men's size: Medium (D) or Wide (EE) widths in whole and half sizes 8-15 (no half sizes 12-15).

Item #	Price	
219026	\$175.00	 Black
		 Dark Earth

**NEW****Detroit XT Mid Boots**

Waterproof/breathable membrane lets vapor out without letting water in. Metatomical footbed for excellent arch support. Reflective webbing and Cleansport NXT™ odor control. Oil- and slip-resistant, non-marking rubber outsole. Steel toe meets ASTM standards. Specify Men's Size and Width: Medium (D) or Wide (EE).

Item #	Size Range	Toe Type	Price
1020039	7-17	Plain	\$150.00
1020085	7-17	Steel	\$160.00

**Atlanta Cool Steel Toe Shoes**

A great alternative to heavy work boots that can leave your feet feeling hot and sweaty. These shoes let your feet breathe without sacrificing safety. Oil- and slip-resistant with a non-marking rubber outsole. Meets ASTM standards. Specify Men's size: Medium (D) width 8, 8.5, 9, 11-13 or Wide (EE) width 9.5, 10.5, 11, 11.5, 12.

Item #	Price
214333	\$89.99

**NEW****Sparta ESD Aluminum Toe Work Shoes**

Electro Static Dissipative (ESD) footwear constructed to reduce excess static electricity. Breathable mesh, non-mutilating upper reduces the chance of marking or scratching. Oil- and slip-resistant, non-marking rubber outsole. Compression-resisting midsole. Left and right asymmetrical aluminum toes. TPU shank. Removable footbed. Meets ASTM and non-slip testing standards. Specify Men's size: Medium (D) or Wide (EE) widths in whole and half sizes 7-15 (no half sizes 12-15).

Item #	Price
1021349	\$115.00

**NEW****Women's Sparta ESD Aluminum Toe Shoes**

Electro Static Dissipative (ESD) footwear constructed to reduce excess static electricity. Breathable mesh and non-mutilating upper. Oil- and slip-resistant, non-marking rubber outsole. KEEN.ReGEN lightweight, compression-resisting midsoles. TPU shank. Removable metatomical PU footbed. CLEANSPOORT NXT™ odor protection. Meets ASTM and non-slip testing standards. Specify Women's Size and Width.

Item #	Price
1021350	\$115.00

**NEW**

Edge LTE Chukka 6"H Composite Toe Boots

Superior lightweight flexibility with comfort and support. Constructed of premium leather with a mesh lining. 4LR™ technology includes comfort footbed with rebound, lightweight stabilizing shank for support, plus an oil- and slip-resisting Bantamweight™ outsole for maximum wear resistance. Meets ASTM standards. Specify Men's size: Medium (D) or Wide (EE) width in whole and half sizes 8-13 (no half sizes 12-13).

Item #	Price
231155	\$129.95

**NEW**

Turbo 6"H Carbon Toe Waterproof Boots

Waterproof Pro™ construction with full-grain leather. Includes rebound foam insole, mesh lining and 90° heel. Oil- and slip-resistant, dual-density PU/TPU outsole. Carbon toe is 100% non-metallic and meets ASTM standards. Specify Men's size: Medium (D) or Wide (EE) width in whole and half sizes 8-13 (no half sizes 12-13).

Item #	Price
231154	\$139.95



Workhog 11"H Square Toe Work Boots

These high-quality customer-favorites are made of premium full-grain leather with a mesh lining and oil- and slip-resistant Duratread™ outsole. Feature a Goodyear welt, stability chassis, 90° heel and a shock-absorbing EVA midsole. Self-cleaning, non-tracking outsole tread. Meets ASTM standards. Specify Men's size: Medium (D) width in whole and half sizes 7-14 (no half sizes 12-14) or Wide (EE) width in whole and half sizes 8-13 (no half sizes 12-13).

Item #	Size Range	Toe Type	Height	Price
228014	7-14	Plain	11"	\$169.99
228015	7-14	Steel	11"	\$179.99

**NEW**

Trail Crazyhorse Steel Toe Work Boots

Built with Goodyear® welt construction, so they can be resoled. Trail Crazyhorse full-grain leather uppers, removable shock-absorbing footbeds and slip-resistant outsole. Fiberglass shank. Meets ASTM standards. Specify Men's size: Medium (D) or Wide (EE) width in whole and half sizes 8-13 (no half sizes 12-13).

Item #	Size Range	Toe Type	Height	Price
231151	8-13	Steel	6"	\$210.00
231150	8-13	Steel	8"	\$220.00



NEW
Danner

Vicious 4.5"H Plain Toe Boots

Top-of-the-line materials like Gore-Tex® and Vibram® with a weight-saving platform. Dual-density EVA midsole for extra shock absorption. Oil- and slip-resistant outsole has a low-profile 90° heel. Abrasion-resistant heel cap, all-leather upper, floating metatarsal guard and waterproof/breathable Gore-Tex liner. Specify Men's Size and Width: Medium (D) and Wide (EE).

Item #	Price
13858	\$179.95



NEW
Danner

Vicious 4.5"H Composite Toe Boots

Top-of-the-line materials like Gore-Tex® and Vibram® with a weight-saving platform. EVA midsole for extra shock absorption. Oil- and slip-resistant 90° heel. Abrasion-resistant heel cap, all-leather upper, floating metatarsal guard and waterproof/breathable Gore-Tex liner. Non-metallic composite toe meets ASTM standards. Specify Men's Size and Width: Medium (D) and Wide (EE).

Item #	Price
13860	\$189.95



NEW
Danner

Radical 452 5.5"H Plain Toe Boots

As light as it is tough, this boot features TERRA FORCE technology which provides exceptional support and stability without the traditional weight. Durable nubuck leather upper with a Gore-Tex 100% waterproof/breathable liner to keep water out. Supportive midsole and sturdy footplate provide comfort. TPU shank. Men's Medium (D) or Wide (EE) width in whole and half sizes 9-13 (no half sizes 12-13).

Item #	Price
45254	\$179.95



Work Boots

Oil-resistant rubber bumper guard and slip-resistant, non-marking polyurethane outsole. Full-grain leather upper, steel shank, covered cushion insole to absorb impact. Steel toe meets ASTM standards. Specify Men's size: Medium (D) width in whole and half sizes 7-17 or Wide (EE) width in whole and half sizes 7-15.

Item #	Size Range	Toe Type	Height	Price
G6274	7-16	Plain	6"	\$119.99
G6374	7-17	Steel	6"	\$124.99
G8274	7-17	Plain	8"	\$129.99
G8374	7-17	Steel	8"	\$134.99



TINGLEY Profile® 15"H PVC Knee Boots

Durable on the outside, comfortable on the inside

High-quality PVC resins and low temperature additives provide abrasion resistance and excellent flexibility in cold temperatures. Injection-molded seamless construction for 100% waterproof protection. Composite safety-toe does not transfer cold or set off metal detectors. 1.5" of Calf Relief Expansion (CRE)™ adds comfort. Cleated outsole spits out debris for excellent gripping action and absorbs shock when walking. Removable polyurethane contour insole features three layers to wick away perspiration and promote fast drying. Composite toe meets ASTM standards. Specify Men's whole sizes 3-14. Order two sizes smaller for Women's (for example: Women's 7 = Men's 5).

Item #	Size Range	Toe Type	Height	Price
230322	3-14	Plain	15"	\$32.99
230323	3-14	Composite	15"	\$34.99



TINGLEY EVA Ultra Lightweight 15"H Plain Toe Boots

It's time to meet your new favorite chore boots. EVA seamless waterproof construction is 70% lighter than other rubber and PVC knee boots, without sacrificing long-wearing comfort or durability. Self-insulating tiny air bubbles keep your feet cooler in the heat and warmer in the cold without losing flexibility. Cleated outsole tread design for good traction and a removable polyurethane contour insole. Specify Men's whole sizes 6-13.

Item #	Price
211674	\$44.99



TINGLEY Economy Knee Boots



Everything you demand from a work boot at an honest value. Injection-molded PVC offers 100% waterproof protection and resists fats, certain acids, hydrocarbons, caustics and more. Sweat-wicking, removable insole dries and cushions feet. Tough, cleated outsole spits out debris and stands up to rough abrasion. Upper made from 30% recycled material stays supple in cold temps. Steel toe meets ASTM standards. Specify Men's whole sizes 7-14.

Item #	Size Range	Toe Type	Height	Price
224197	7-14	Plain	15"	\$17.99
224198	7-14	Steel	15"	\$19.99



TINGLEY Flite™ Knee Boots



Anti-fatigue boots are made with a unique polymer material that is chemical resistant against fats, oils, alcohols, acids, ketones and caustics. Liquid proof seamless upper with extra calf space for easy on/off. Black pair features cleated outsoles and blue pair has outsoles better suited for wet or contaminated surfaces. Beveled heel helps reduce leg and back strain. Self-insulating, tiny air bubbles keep feet warm when it's cold and cool when it's hot. Meets ASTM standards. Specify Men's whole sizes 7-15. Order two sizes smaller for Women's (for example: Women's 7 = Men's 5).

Item #	Size Range	Color	Toe Type	Height	Price	
230320	7-15	Blue	Composite	15"	\$84.99	 Blue
230321	7-15	Black	Composite	15"	\$84.99	 Black



Muckster II Shoes and Ankle Boots

Added stability on wet surfaces, greater comfort and better fit. Slip them on and kick them off. 4mm neoprene insulation and breathable Muck Airmesh lining keep feet dry and comfortable. High-traction rubber outsoles. Specify color: bark or black; and Men's whole sizes 7-15.

Item #	Size Range	Toe Type	Height	Price	
225752	7-15	Plain	6"	\$115.00	 Black
225750	11	Plain	4"	\$86.99	 Bark
225750	7-15	Plain	4"	\$95.00	



Chore Boots

Thick CR flex-foam bootie has a triple-reinforced toe and quadruple-reinforced heel for maximum protection and durability. Wide heel base provides greater stability. Flexible upper forms to virtually any calf height and can be rolled down to a shorter height. Removable cushioned insole. Steel toe meets ASTM standards.

Item #	Size Range	Toe Type	Height	Price
214543	5-16	Plain	12"	\$109.95
214542	6-16	Plain	16"	\$114.95
214544	5-14	Steel	16"	\$139.95



Cool Series All-Conditions Chore Boots

XpressCool™ lining pulls moisture away from your skin and speeds evaporation. Waterproof boots have a CR flex-foam bootie with four-way stretch nylon and a sockliner lining that reduces friction and heat buildup. Triple-reinforced toe and quadruple-reinforced heel are diamond textured to fight off scuffs and scratches. Vibram® outsole. Steel shank. Brown. Steel toe meets ASTM standards. Specify Men's whole sizes 5-16 (218917 & 218916), 5-14 (218915).

Item #	Size Range	Toe Type	Height	Price
218917	5-16	Plain	12"	\$134.95
218916	5-16	Plain	16"	\$139.95
218915	5-14	Steel	16"	\$154.95



Arctic Sport™ Extreme Conditions Boots

The cold-weather protection of a traditional pac boot plus the ease and convenience of a slip-on. Thick 5mm CR flex-foam bootie and a 2mm thermal foam underlay. Lightweight and flexible. Specify Men's whole sizes 5-15. No size 5 in 16"H boots.

Item #	Size Range	Toe Type	Height	Price
162021	5-15	Plain	12"	\$164.95
214541	6-15	Plain	16"	\$169.95



Edgewater II Multi-Purpose Boots

Protective, warm and one of the easiest tall boots to put on and take off. Features 5mm CR Flex-Foam, breathable Airmesh lining, extended rubber coverage, Achilles reinforcement and an aggressive waffle high-traction outsole. Specify color: black or green; and Men's whole sizes 7-15.

Item #	Toe Type	Height	Price	
227940	Plain	12"	\$119.99	 Black
227941	Plain	14"	\$129.99	 Green



NEW



Edgewater Classic Hi-Vis Boots

100% waterproof and durable as can be, Muck boots slog through anything. Now they're great for low-light conditions, too. Just turn down the top to show the hi-vis yellow lining. Rubber and neoprene upper with breathable Airmesh lining for comfort. Nzyme treatment for odor control. Toe and heel reinforcement. All-terrain outsole. Plain toe. Specify Men's whole sizes 8-14.

Item #	Price
231232	\$140.00



Muckster II Women's Waterproof Shoes

Added stability on wet surfaces, greater comfort and better fit. Slip them on and kick them off. 4mm neoprene insulation and Muck breathable Airmesh lining keep feet dry and comfortable. Self-cleaning, high-traction rubber outsole. Plain toe. Green color. Specify Women's whole sizes 5-11.

Item #	Price
225751	\$90.00



Woody Max 16"H Insulated Boots

Woody Max boots are the ultimate outdoor boots. Aggressive outsole provides maximum protection and stability. 5mm CR flex-foam bootie with four-way stretch nylon is 100% waterproof. Fleece lining, plus 2mm thermal foam underlay added to instep area for additional warmth. EVA molded midsole with contoured footbed. Plain toe. Specify Men's whole sizes 7-14.

Item #	Price
139295	\$184.99



SERVUS MAX™ 15" H Plain Toe Boots

These over-the-sock boots have a soft molded footbed that hugs your foot comfortably like a shoe. Injection molding technology puts softer, more flexible material in the uppers while the soles have a harder, high-durability material. Seamless construction, replaceable insoles and a steel shank. Long-wearing, slip-resistant outsoles. Specify Men's whole sizes 7-15.

Item #	Price
G75120	\$38.00



SERVUS 14" H Plain Toe PVC Boots

Step-in work boots that stand up to everyday chores. Crack-resistant PVC compound resists chemicals and barnyard wastes. Removable and hand-washable insole improves foot hygiene. Anti-skid outsole is not deep cleated; rather, it has many biting edges for traction. Specify Men's whole sizes 6-13.

Item #	Price
18822	\$20.00



NEW
XTRATUF Swingsaw 15" H Plain Toe Boots

How do you stay secure on wet ice, or a wet, icy, rolling deck? You wear these boots. Their outsoles feature GlacierTrek™ PRO, a superior ice traction technology paired with SRC slip-resistance for enhanced traction. Boots are 100% waterproof and the rubber uppers are oil, acid and chemical resistant. Spandura® covered 5mm neoprene bootie keeps feet warm down to -20°F. Ideal for commercial fishermen and recreational ice fishermen alike. Specify Men's whole sizes 8-13.

Item #	Price
231236	\$179.95



NEW
XTRATUF Women's 6" H Ankle Deck Boots

Not commercial-grade boots, but comfortable and sure-gripping for recreational fishing. 100% waterproof rubber uppers, with front and rear pull loops for easy on/off. Chevron outsoles provide a sure grip without marking or tracking. Ankle height for walking comfort. Plain toe. Specify color: navy/pink or seafoam; and Women's whole sizes 5-11.

Item #	Price	Color
231235	\$89.95	Navy/Pink
		Seafoam



SERVUS Women's MAX™ 15" H Plain Toe Boots

These women's over-the-sock boots have a soft molded footbed that hugs your foot comfortably like a shoe. Injection molding technology puts softer, more flexible material in the uppers while the soles have a harder, high-durability material. Seamless construction, replaceable insoles and a steel shank. Long-wearing, slip-resistant outsoles. Specify Women's whole sizes 5-11.

Item #	Price
G75126	\$38.00



NEW
XTRATUF 6" H Ankle Deck Boots

Not commercial-grade boots, but comfortable and sure-gripping for recreational fishing. 100% waterproof rubber uppers, with front and rear pull loops for easy on/off in the wettest conditions. Chevron outsoles provide a sure grip without marking or tracking. Plain toe. Specify Men's whole sizes 8-13.

Item #	Size Range	Color	Color
231233	8-13	Black	Black
			Mossy Oak Bone Fish
231234	8-13	Mossy Oak	
			\$99.95



GEMPLERS Brown Bear™ Boots

A thick, removable, cushioned insole surrounds feet like a broken-in pair of sneakers. Self-cleaning outsole provides the perfect combo of traction and stability without the weight of heavy-soled leather boots. Shock-absorbing heel pads add comfort. Molded ladder bar shank. Ideal for agriculture, grounds maintenance, construction and other general-use applications. Steel toe meets ASTM standards. Specify Men's whole sizes 7-14.

Item #	Size Range	Toe Type	Height	Price
139026	7-14	Plain	16"	\$36.99
139027	7-14	Steel	16"	\$37.99



DUNLOP 6"H Plain Toe Lace-Up PVC Boots

Whether it's the dairy barn, processing floor, nursery or greenhouse, these lace-up boots provide all-day comfort and safety. Dunlop PVC boots are waterproof, chemical resistant and economical. Feature self-cleaning, non-slip sole and a removable, washable cushion insole. Steel shank. Specify Men's whole sizes 6-13.

Item #	Price
G86103	\$31.99



DUNLOP White Waterproof Boots

These PVC boots are ideal for working in wet, slippery conditions such as food processing, shrimping and commercial fishing. Slip-resistant safety-loc outsole for superior traction on slippery surfaces. Steel shank. Steel toe meets ASTM standards. Specify Men's whole sizes 7-13.

Item #	Size Range	Toe Type	Height	Price
G81011	7-13	Plain	16"	\$27.99
G81012	7-13	Steel	16"	\$29.99



NEW BAFFIN Women's Prime Plain Toe Boots

These comfortable, all-season knee boots will be your new favorite. Constructed of a durable, oil- and acid-resistant ultra-flex compound. Rippled outsole. Black with amber outsole. Specify Women's whole sizes 5-10.

Item #	Price
231164	\$50.00

**NEW****BOGS® Women's Neo-Classic 13"H Farm Boots****Seamless Construction = 30% Lighter Boots**

Snow, slush, mud, manure - these boots stride through it all, and your feet stay 100% dry and warm. Seamless rubber shell with 7mm Neo-Tech waterproof insulation. Gel-cushioned EVA footbeds, slip-resistant Bio-Grip outsoles and Flex-Width insole system that adapts to foot width. Comfort rated to -58°F. Plain toe. Specify Women's whole sizes 6-12.

Item #
231162

Price
\$130.00

**NEW****BOGS® Bedrock 6"H Composite Toe Waterproof Boots**

Finally, waterproof BOGS Boots with the leather uppers you like. Loaded with the company's usual innovative features, like the seamless heel/outsole combo, composite safety toes that are custom built to each size, the Flex-Width insole system that adapts to wide feet and Bogs Max-Wick and EverDry that move sweat away to keep feet dry. Slip- and chemical-resistant Bio-Grip outsoles. Meets ASTM standards. Specify Men's whole and half sizes 8-15 (no half sizes 12-15).

Item #
231163

Price
\$170.00

**NEW****BOGS® Workman 13.5"H Plain Toe Insulated Boots****Seamless Construction = 30% Lighter Boots**

Your feet stay warm and dry with a 100% waterproof rubber shell and inner Neo-Tech stretch bootie for insulation. Rebound cushioning returns energy to your feet. Bio-Grip soles fight slippage, while EVA midsoles wick sweat and fight stink. Flex Width insole system adapts to wider feet. Comfort rated to -72°F. Specify Men's whole sizes 7-15.

Item #
231159

Price
\$150.00



LACROSSE' Grange 18"H Plain Toe Rubber Boots

These famous boots are still made from proven ZXT rubber that remains durable and waterproof year after year. Comfortable, snug "ankle fit" prevents these boots from being pulled off in the mud and muck. Removable EVA footbed, top strap with buckle adjustment and fiberglass shank for arch support. Specify Men's whole sizes 5-15.

Item #	Price
15004	\$89.99



LACROSSE' 16"H Insulated Rubber Knee Boots

High-quality rubber over-the-sock work boots for farming or industrial use in temperatures down to 0°F. Cellular foam insulation in first 6" of boots (along with wool felt midsole) protects ankles and feet. Removable EVA footbed. Fiberglass shank and aggressive non-slip outsole. Plain toe. Specify Men's whole sizes 8-15.

Item #	Price
18901	\$94.99



LACROSSE' Burly 18"H Insulated Rubber Boots

These waterproof boots are a favorite of hunters and trappers because they stand up to hard wear. Made of thick, high-grade rubber that resists tears and punctures. Insulated with polymeric foam to keep your feet and ankles warm. Chevron cleated sole provides optimal traction. Snug "ankle fit" design prevents boots from being pulled off in the mud. Features removable EVA footbed, top strap with buckle adjustment and fiberglass shank. Plain toe. Specify Men's medium width in whole sizes 8-15.

Item #	Price
G26604	\$99.99



LACROSSE' 18"H Two-Buckle Insulated Rubber Boots

Over-the-sock insulated boots provide 100% waterproof protection on the coldest of days. Made of ozone-resistant rubber with two buckle closures for a quick, snug fit. Nylon lining. Non-slip Trac-Lite™ tread. Removable EVA footbed and fiberglass shank. Plain toe. Specify Men's whole sizes 8-14.

Item #	Price
G26704	\$109.99



NEW

BAFFIN Titan Plain Toe Winter Boots

These winter boots will keep you warm in the coldest conditions with a -148°F comfort-rated inner boot system. Aggressive, long-wearing and self-cleaning outsole design. Fully moulded waterproof boots include a 1" snow cuff and a micro cellular waffle footbed that traps air and moisture. Lightweight, flexible TR compound material. Specify Men's whole sizes 8-13.

Item #	Price
231165	\$165.00



NEW

BAFFIN Workhorse Composite Toe Pac Boots

These safety toe winter boots are temperature rated down to -76°F. Feature a polyurethane-coated leather upper, micro cellular waffle footbed that traps air and moisture and metal-free, non-detectable safety components and hardware. Rubber outsole, polyurethane base and stitching are oil and acid resistant. Meets ASTM standards. Specify Men's whole sizes 8-13.

Item #	Price
231166	\$259.00



NEW

BAFFIN Impact Plain Toe Pac Boots

These winter boots provide your feet extreme weather protection and warmth down to -148°F. Waterproof nylon snow collar with Diamond-Lite insulated nylon uppers. Arctic rubber shell, EVA midsole and polar rubber outsole. Double-buckles keep them secure, while B-Tek insulation keeps your toes extra warm. Removable multi-layer inner boot system. Specify Men's whole sizes 8-13. NOTE: Boots run small, consider ordering a size up.

Item #	Price
231169	\$256.00



SERVUS 10\"/>

Rated to -75°F, these steel toe pac boots tackle cold weather applications like a champ - especially where toe protection is required. Built with a rugged leather top and 100% waterproof natural rubber bottom. Feature removable, washable and replaceable Thermolite® foam insulation for warmth. Cleated soles provide traction in snow and mud. Steel shank. D-ring lacing system. Meets ASTM standards. Specify Men's whole sizes 7-14.

Item #	Price
A442	\$117.99



Workbrutes® Size Guidelines for Various Footwear				
Overshoe Size	Low Profile Oxford & Sport Style Work Shoes		Work Boot & Hiker Boot Styles	
	Men's	Women's	Men's	Women's
XS	6.5-7	7.5-9	8.5	9.5-11
S	7.5-9	9.5-11	9.5-11	11.5-13
M	9.5-11	11.5-13	11.5-13	13.5-15
L	11.5-13		13.5-15	15.5-17
XL	13.5-15			
2XL	15.5-17			



TINGLEY Workbrutes® G2 PVC Overshoes

Protect your leather work boots from liquids, mud and harsh chemical environments with these injection-molded, seamless PVC overshoes. More room in the toe to fit easily over steel toe boots and other large shoes. Expansion pleats and a unique thumb pocket for easy donning. Heel kicks for hands-free removal! Remain flexible in cold temps. Increased thickness in high wear areas for longer life. Slip-resistant cleated outsoles. Specify Men's size XS-2XL.

Item #	Size Range	Toe Type	Height	Price
45811	XS-2XL	Plain	5.5"	\$28.92
45821	XS-2XL	Plain	10"	\$34.82
45851	XS-2XL	Plain	17"	\$38.38



DUNLOP PVC Overboots

Protect your expensive boots and shoes from muck with these super durable overboots. PVC Flex-O-Thane construction provides superior chemical resistance and cold-weather flexibility. One-piece construction means no failed seams and total waterproof protection. Slip-resistant sole keeps you firmly on your feet. Wide-opening top with snap-down flap. Kick-off lugs help you slip in and out of boots without hassle. Fit over most boots and shoes. Specify Men's shoe size: XS (4-5), S (6-7), M (8-9), L (10-11), XL (12-13) or 2XL (14-15).

Item #	Size Range	Toe Type	Height	Price
G86020	XS-2XL	Plain	10"	\$23.99
G86030	XS-2XL	Plain	17"	\$29.99



SERVUS PVC Overboots

Heavy-duty overboots fit comfortably over popular leather styles with padding, insulation, wedge outsoles and wide toe spaces. Injection-molded PVC with a seamless design guaranteed to be 100% waterproof. Dual-compound material permits a light, stretchable upper to be molded to a high-abrasion and slip-resistant sole. Reinforced bumpers on toes and heels. Large tabbed button closures so you won't need to take off gloves when putting boots on or taking them off. Specify Men's shoe size: S (6-8), M (9-10), L (11-13) or XL (14-15).

Item #	Size Range	Toe Type	Height	Price
G31102	S-XL	Plain	12"	\$29.99
G31100	S-XL	Plain	4"	\$34.00



LACROSSE Utah Brogue II 13"H Rubber Overboots

These overboots have been the contractor's friend for years. They are designed to fit over your work boots/shoes and are guaranteed to keep you 100% dry. Non-insulated, natural, ozone-resistant rubber. Diamond chevron pattern sole for traction. Rubber take-up straps adjust to fit. Nylon lining for easy on/off. Made for boots with larger soles. Specify Men's whole sizes 7-16.

Item #	Price
G30030	\$69.99



NEOS OVERSHOES
STABILicers® Voyager™
11"H Overshoes

Perfectly combines an anti-skid outsole with a 100% waterproof protectant—you'll stay on your feet and your boots will look good longer. The 500-denier nylon upper is long-wearing and opens wide to accommodate all kinds of footwear, including steel toe work boots. Hook-and-loop front and adjustable strap across the vamp ensure a proper, snug fit. Lightweight and easy to store. Convenient back pull strap. Specify Men's shoe size: M (7.5–9), L (9.5–11), XL (11.5–13) or 2XL (13.5–15). NOTE: We recommend going up a size when wearing these overshoes over work boots.

Item #	Price
139251	\$102.99



Adventurer 15"H
Heavy-Duty
Overshoes

Calf-high coverage protects your footwear and pant legs in mud or snow. Overshoes keep your feet warm down to 0°F. Tough 500-denier nylon upper with 100% waterproof membrane shields you from the elements. Duraflex® quick-release buckle ensures a snug fit and allows for easy on and off. Specify Men's shoe size: M (7.5–9), L (9.5–11), XL (11.5–13) or 2XL (13.5–15).

Item #	Size Range	Toe Type	Height	Price
211655	XL	Plain	15"	\$109.99
211655	M-2XL	Plain	15"	\$115.00



Navigator -20°F
Insulated Overshoes

Built-in 5"H extendable gaiter gives you adjustable protection up to 20"H when trekking through deep snow. Aggressive tread pattern helps keep you on your feet. Durable 840-denier polyester. Lightweight, waterproof overshoes deliver a superior fit and a warm layer of insulation in frigid temperatures (down to -20°F). Duraflex® quick-release closure for easy on/off. Specify Men's shoe size: M (7–8.5), L (9–10.5), XL (11–12.5) or 2XL (13–14.5).

Item #	Price
211656	\$115.00



Contractor 15"H
Overboots

Extremely flexible, 100% waterproof, all-rubber and oversized to fit comfortably over work boots and shoes. Feature a slip-, abrasion-, chemical- and oil-resistant outsole with Cross Rib™ tread pattern for secure footing. Ozone-resistant rubber fights cracking for longer wear. Adjustable snug-up side strap gives you a better fit. Cotton duck lining for easy on/off. Specify Men's whole sizes 8–16.

Item #	Price
218914	\$60.00



DUNLOP
Steel Toe Chest Waders

Durable, heavy-duty PVC upper has a polyester backing for comfort while you're in wet or sloppy conditions. Injection-molded seamless boot construction is designed to keep water out and offer excellent cold-weather flexibility. Can be folded or rolled for storage without cracking. Features adjustable polyester nylon strap, built-in belt loops and non-absorbent lining. Resist oil, grease, gasoline, saltwater and ozone. Meets ASTM standards. Specify Men's whole sizes 8-13.

Item #	Price
218849	\$129.99



DUNLOP
35\"/>

Flexible PVC upper is welded to injection-molded PVC boots for a hip boot that has excellent resistance to oil, grease, saltwater and ozone. Lightweight, durable and pliable in cold weather. Won't crack when folded or rolled up. Polyester lining provides abrasion resistance and quick on/off. Steel shank. Plain toe. Specify Men's whole sizes 7-13.

Item #	Price
G86055	\$83.99



NEW

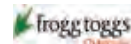

Brush Hogg Heavy-Duty Nylon Hip Waders

These hip waders have a waterproof/breathable nylon outer shell for excellent abrasion resistance. Rubber 4mm neoprene Outlander boot with cleated outsole and EVA midsole offers durability and flexibility. Removable shoe bed for added comfort. Integrated adjustable belt leash. Fully taped seams. Plain toe. Specify Men's whole sizes 7-14.

Item #	Price
231090	\$159.99



NEW



Rana II™ PVC Chest Waders

Non-insulated 2mm PVC boot with cleated outsole. Nylon-reinforced PVC upper with waterproof boot attachment and 100% taped seam construction that will keep you dry year after year. Adjustable H-back web suspenders with durable quick-release buckles. Flip-out chest pocket and top drawcord. Dark brown. Specify Men's whole sizes 7-13.

Item #	Price
231086	\$74.99



NEW



Amphib Neoprene Chest Wader

Designed to keep you in the field 3.5mm neoprene upper with hi-back upper design. Adjustable neoprene suspenders. Features 200-gram Thinsulate™ insulated rubber boots, reinforced knees and a hand-warmer pocket. Dark green. Specify Men's whole sizes 7-14.

Item #	Price
231087	\$149.99



NEW



Classic Rubber Hip Wader

All seams are stitched and taped and are 100% waterproof. Adjustable belt leash and contoured leg opening ensures a comfortable fit. Brown. Specify Men's whole sizes 7-13.

Item #	Price
231089	\$69.99



Hiker Boot Socks With Full Cushion

"Must pack" durability meets undeniable comfort in a full cushion sock that absorbs the rigors of any terrain. Sits mid-calf for added protection and warmth. No slipping, bunching or blisters. High-density cushioning throughout the entire sock. Pulls moisture from skin. Repels bacteria and odors. 66% Merino wool, 32% nylon, 2% Lycra® spandex. Specify color and Men's size: M (8-9.5), L (10-12) or XL (12.5-14.5).

Item #	Price	
230999	\$25.00	Charcoal
		Olive



William Jarvis Boot Socks with Full Cushion

Take your boots from fairly comfortable to amazing with the best socks you'll ever own. Named for the man who first brought Merino Wool to Vermont. High-density cushioning throughout entire sock. Naturally antimicrobial to repel bacteria and odors. Sits mid-calf. 67% Merino wool, 31% nylon, 2% Lycra® spandex. Specify Men's size: M (8-9.5), L (10-12) or XL (12.5-14.5).

Item #	Price	
231000	\$25.00	



Hiker Ankle Socks

Legendary Darn Tough construction for when "equipment failure" is not an option. Mid-level cushion density under foot. Performance fit means no bunching, no slipping, no blisters. All-weather performance - cool in the summer, warm in the winter. Pull moisture away from skin, plus naturally antimicrobial to repel bacteria and odor. 61% Merino wool, 37% nylon, 2% Lycra® spandex. Specify color and Men's size: S (5.5-7.5, black only), M (8-9.5), L (10-12) or XL (12.5-14.5).

Item #	Price	
1959	\$18.00	Black
		Oatmeal
		Denim



Steely Micro Crew Socks

Feel as good at the end of the day as they do when you first put them on. Full cushion toe box is designed to provide comfort while wearing steel toe boots. Mid-level cushion under foot. A shorter version than your traditional crew sock - peeks just above the top of a standard hiking boot. Naturally antimicrobial to repel bacteria and odors. 55% Merino wool, 42% nylon, 3% Lycra® spandex. Specify Men's size: M (8-9.5), L (10-12) or XL (12.5-14.5).

Item #	Price	
231006	\$21.00	



Uncle Buck Boot Socks

Uncle Buck mid-calf socks handle the most unpredictable terrain in comfort with a mid-level cushion density under foot. Sock pulls moisture away from skin and is naturally antimicrobial. Cool in summer, warm in the winter. Undetectable seam for a smooth, invisible feel. 60% Merino wool, 38% nylon, 2% Lycra® spandex. Specify Men's size: M (8-9.5), L (10-12) or XL (12.5-14.5).

Item #	Price	
1949	\$24.95	



ABC Boot Socks

Sock design includes aliens, bears and camels, everything you're likely to see on an un-average hike. Built with a mid-level cushioning to keep you cozy when the going gets weird. Sits mid-calf. Like other Darn Tough socks there is no slipping, bunching or blisters when wearing this sock. 60% Merino wool, 38% nylon, 2% Lycra® spandex. Specify Men's size: M (8-9.5), L (10-12), XL (12.5-14.5).

Item #	Price	
1964	\$24.95	



NEW



Women's Treeline Micro Crew Socks

From pines to alpine, the Treeline micro crew is a trail staple hike sock designed to pound out elevation and distance. Cushy Merino wool construction absorbs impact and minimizes moisture so the only thing between you and the summit is rugged determination, not rugged terrain. Mid-level cushion density under foot. Micro crew height peeks just above the top of a standard hiking boot. 63% Merino wool, 35% nylon, 2% Lycra® spandex. Specify Women's size: S (4.5-7), M (7.5-9.5), or L (10-11.5).

Item #	Price	USA★ MADE
1971	\$22.95	



NEW



Women's Bear Town Micro Crew Socks

This is the only bear your feet will want to encounter when you're exploring the great outdoors. Light and strong with a thin layer of cushioning along base of foot. Micro crew is a shorter, more concise take on the traditional crew height - peeks just above the top of a standard hiking boot. 54% nylon, 43% Merino wool, 3% Lycra® spandex. Specify Women's size: S (4.5-7), M (7.5-9.5), or L (10-11.5).

Item #	Price	USA★ MADE
1970	\$20.95	



Women's Micro Crew Hiker Socks

A shorter, more concise take on the traditional crew height. Peeks just above the top of a boot. Medium cushion density under foot provides cushioning without bulk. No slipping, bunching or blisters. 59% Merino wool, 39% nylon, 2% Lycra® spandex. Specify Women's size: S (4.5-7), M (7.5-9.5) or L (10-11.5).

Item #	Price	USA★ MADE
231007	\$22.00	



Women's Her Spur Boot Socks

Merino Wool keeps them desert dry, while silky, light cushion adds miles to any journey from one climate to the next. True Seamless™ construction gives you an undetectable seam fusion for an ultra smooth, invisible feel. Sits mid-calf for added protection and warmth. 52% nylon, 45% Merino wool, 3% Lycra® spandex. Specify Women's size: S (4.5-7), M (7.5-9.5) or L (10-11.5).

Item #	Price	Denim	Taupe
1969	\$22.00		

USA★
MADE



Women's Full Cushion Hiker Boot Socks

Merino wool blend provides breathable comfort in all conditions. Extra cushioning designed to fit smaller, female feet. Pulls moisture away from your skin. Naturally antimicrobial to repel bacteria and odors. Mid-calf height. 69% Merino wool, 27% nylon, 4% Lycra® spandex. Specify Women's size: S (4.5-7), M (7.5-9.5) or L (10-11.5).

Item #	Price	USA★ MADE
231001	\$25.00	



NEW



Women's Mountaineering Extra Cushion Socks

Go all day strong with these women's over-the-calf socks. Extra cushion is perfect for long-distance hiking through sub-zero wind chills. Designed simple. Built tough. 72% Merino wool, 26% nylon, 2% Lycra® spandex. Specify Women's size: S (4.5-7), M (7.5-9.5) or L (10-11.5).

Item #	Price	USA★ MADE
1954	\$29.95	



NEW



Norsk Classic Ragg Wool Crew Socks

Classic ragg wool adds thermostatic insulation and has been keeping hikers warm and comfortable for centuries. Technical know-how adds performance and durability while retaining that classic ragg look. Memory-knit construction keeps shape, wash after wash. Reinforced toe and heel for longer sock life. 80% wool, 19% nylon, 1% spandex. Specify Men's size: M (6-8.5), L (9-11.5) or XL (12-14.5).

Item #	Price
231216	\$17.00



NEW



Outlander Heavyweight Wool Boot Socks

Thermalined construction provides warmth all day. Exceptionally soft and cushiony for comfort and to absorb shocks. Wick Dry® technology keeps feet dry. Reinforced toe and heel, plus a smooth, flat comfort toe seam. Mid-calf length. 65% acrylic, 20% worsted wool, 14% stretch nylon, 1% spandex. Specify color and Men's size: M (6-8.5), L (9-11.5) or XL (12-14.5).

Item #	Price	Color
231217	\$12.00	Gray
		Navy
		Olive
		Drab



Worsted Wool Boot Socks

Worsted wool is woven tighter, softer and more durable than regular wool. Full elastic rib leg to prevent them from falling down inside your boots. Over-the-calf length. 84% worsted wool, 9% acrylic, 6% nylon, 1% spandex. Specify Men's size: M (6-8.5), L (9-11.5) or XL (12-14.5).

Item #	Price
FR726	\$17.99



NEW



Force® Performance Steel Toe Crew Socks

When you wear steel toe boots on the job, you'll appreciate the cushioning and durability of these socks. Sweat-wicking, odor-fighting and double-cushioned on the toes and top of the foot for protection. Reinforced heel and toe. 63% polyester, 34% nylon, 3% spandex. A0001. Pkg. of 2 pair. Size L only. Specify color.

Item #	Price	Color
A0001	\$15.99	Red
		Black



NEW



Force® Performance Crew Socks

Everyday socks you can wear year round. These comfortable crew socks are 96% polyester/4% spandex with a reinforced heel and toe to help protect against blisters. Wicks sweat and fights odors. Reinforced arch and spandex add stability and holds sock in place. A442. Pkg. of 3 pair. Size L only. Specify color.

Item #	Price	Color
A442	\$15.99	White
		Charcoal
		Black



Arctic Wool Heavyweight Boot Socks

Designed to keep you warm through the coldest conditions. Wicks sweat and fights odors. Abrasion-resistant reinforcement throughout the entire sock. 68% wool, 24% nylon, 1% spandex, 7% other fiber. A3915. Specify Men's shoe size: L (6-12) or XL (11-15).

Item #	Price
193128	\$16.99



**Crosspoint
Lightweight
Waterproof Socks**

Lightweight construction is ideal for active days and hot conditions. Three-layer construction (knit exterior, waterproof/breathable membrane, moisture-wicking anti-bacterial lining) keeps water out while preventing heat buildup. Reinforced toe and heel for comfort and durability.

Item #	Price	 Pink
230611	\$35.00	 Black
		 Gray



**Crosspoint
Midweight
Waterproof Socks**

Constructed for moderate activity and temperate conditions. Three-layer construction (knit exterior, waterproof/breathable membrane, moisture-wicking anti-bacterial lining) keep your feet dry—not sweaty. Reinforced toe and heel for comfort and durability. Look like normal socks, but protect like rain boots. Specify color and size.

Item #	Price	 Black/Gray
230612	\$36.00	 Black/Red



**Crosspoint Wool
Waterproof Socks**

Sock lining provides insulation that's ideal for cooler temperatures. Three-layer construction (knit exterior, waterproof/breathable membrane, Merino wool anti-bacterial lining) keeps your feet dry, not sweaty. Reinforced toe and heel. Look like normal socks, but protect like rain boots - with all the natural benefits of Merino wool. Specify size: S/M (men's 6-7, women's 7-9), M/L (men's 7-10, women's 9-12), L/XL (men's 10-12) or 2XL (men's 12-15.5).

Item #	Price
230613	\$39.00



**WIGWAM At Work Crew
Socks**

Treated with Odor Guard®. Stay-put leg and cuff. White: 86% ring-spun cotton, 9% stretch nylon, 3% rubber elastic, 2% polyester; black and gray: 67% ring-spun cotton, 17% acrylic, 13% stretch nylon, 3% rubber elastic. Three-pair pack. Specify color and Men's size: M (5-9), L (9-12) or XL (12-15).

Item #	Price	 Gray
223486	\$19.99	 White
		 Black



**WIGWAM Diabetic Thermal
Socks**

Warm 65% acrylic, 20% Merino wool, 10% stretch nylon, 5% stretch polyester insulates and helps wick moisture away from the foot. Relaxed-fit leg. Long-wearing, reinforced sole. Accepted by the American and Canadian podiatric medical associations. Specify color and Men's shoe size: M (5-9), L (9-12) or XL (12-15).

Item #	Price	 Gray/Black
224471	\$13.99	 Gray/Denim



**Ultimate Rubber Boot
Socks**

A perfect sock to team with your rubber boots. These heavyweight socks provide maximum comfort due to their outlast fibers that regulate and control temperature. Shin of sock is cushioned so boot isn't uncomfortable against the skin. Features stay-put leg and top, plus seamless toe closure. Black. Specify size: M (men's 5-9.5, women's 6-10), L (men's 9-12, women's 10-13) or XL (men's 12-15).

Item #	Price
P0477	\$20.00





Boot Dryer with Glove Dryer Accessory

Thermal convection drying process lets warm air rise through dryer tubes, drying boots and gloves without shrinkage or stiffness. It also prevents damage to leather footwear and gloves from heat. Simply attach either the boot drying attachment or the glove drying attachment to the dryer. Silent operation is ideal for everyday household use. Includes dryer plus boot and glove drying attachments (one pair each).

Item #	Price
21863	\$54.99



Forced-Air Boot Dryer with Timer

Quiet fan for maximum air movement results in faster drying times. Includes a timer that can be set for as little as 10 min. or up to 180 min.—with or without heat. Four DryPorts allow you to dry two pairs at the same time. 12" L boot extensions (Item # H2) and glove attachments (Item # 24211) are sold separately. Plugs into standard household service (115V, 60 Hz).

Item #	Price
156307	\$89.99



Standard Boot/Shoe Dryer

Extend the life of expensive leather footwear by allowing leather to breathe and retain its natural oils. Thermal convection drying process lets warm air rise through dryer tubes, drying boots without shrinkage or stiffness. Removes perspiration, wetness and odor from any type of shoe or boot. Designed for use with leather, vinyl, plastic, cloth/canvas and Gore-Tex®. For pac boots, you can even leave boot liners in and dry both overnight. Silent operation is ideal for everyday household use.

Item #	Price
E16W	\$39.99



Glove Dryer Accessory

Glove dryer accessory connects to the PeeT Boot and Shoe Dryer (Item #s E16W, E16W2 or 156307) to dry your gloves and mittens from the inside out. Removes cold, wet and sweat from gloves and mittens with ease and is shaped like a hand so fingers are separated for fast, complete drying. Unique thermal convection drying process lets warm air rise through dryer tubes to dry gloves without shrinkage or stiffness. One pair.

Item #	Price
24211	\$19.99



Standard Boot Dryer with 12" H Extensions

Boot dryer uses a thermal convection drying process to remove perspiration, wetness and odor from any type of shoe and boot. With the included 12" H extensions, you can dry taller boots. Does not blow hot air, so all footwear is dried without shrinkage or stiffness. Silent operation is ideal for everyday household use.

Item #	Price
E16W2	\$49.99



Ultra Compact Dryer and Deodorizer

Dries moisture (water or sweat) from footwear. O3 technology destroys odor and pollution molecules for good. Makes boots last longer and smell fresh. Compact enough to take with you or store for later use. Insert directly into footwear.

Item #	Price
228107	\$49.99



GEMPLER'S Chore Boot Rack

Extend the life of expensive boots by reducing the bending and cracking that breaks them down. Boots dry faster when they're spread out and off the ground. Install one in your mud room, shed or near the heater. 1/4" rust-resistant galvanized steel form easily handles four pairs of heavy rubber waders, hip boots or chore boots. Includes three screws and three brackets for mounting. Measures 35"W x 4.75"H x 10.5"D.

Item #	Price
222236	\$19.99



EAGLE Small-Scale Spill Containment Tray

You'll want to use this multipurpose HDPE containment tray in your workshop, mud room or under your machinery - anywhere you need to contain fluids and debris. Holds four pairs of boots or 5 gallons of liquid. Ribbed bottom. Black color. Measures 36"L x 18"W x 2"D.

Item #	Price
150179	\$25.99



Extended-Length Shoe Horns

Slip into your shoes or boots without crushing the heels. Durable steel has a smooth, powder-coat finish that won't snag on your socks. Red color.

Item #	Length	Price
159865	23"	\$13.99
159864	12"	\$8.99



Kevlar® Boot Laces

You won't find a more durable boot/shoe lace. These laces are so strong, they will outlast your work boots. Constructed of the same Kevlar material that bulletproof vests are made from. One pair. 54" boot laces fit most 6"H work boots and 72" boot laces fit most 8"H work boots.

Item #	Length	Price
KV54	54"	\$4.99
KV72	72"	\$6.99



O'Keeffe's Healthy Feet Cream

Provides maximum relief for your dry, cracked and split feet (or hands). This glycerin-based formula allows the cream to penetrate your skin to soften and heal damaged skin without feeling greasy. Odorless formula is great for sensitive skin and noses. 3.4-oz. tub.

Item #	Price
125894	\$7.49



NEW



Trench Warfare Grunt Powder Foot and Boot Spray

Hard working men know they need to take care of what protects them most. That's why Duke Cannon Grunt Powder is designed to keep your feet dry, friction-free, and smelling correct. This product is built for 12 hour work days, not 30 minute webinars.

Note: not for sale in (AL;GA).

Item #	HM	Price
193148	▲	\$8.99



▲ Requires special handling due to DOT regulations. Additional shipping charges will apply. Cannot be shipped by air.



Pro Traction Device for Shoes and Boots



Work with confidence while on hard-packed snow or ice without fear of slipping or falling. No "learning to walk" as this traction device offers the same stability as your natural walk. SkidLock coil system creates secure footing without any feeling of slippage either side to side or front to back. Specify Men's shoe size: S (5-8.5), M (9-11), L (11.5-13.5) or XL (14+).

Item #	Price
134432	\$32.99



Hike XP Traction System

Strap on STABILicers original traction cleats that feature STABILicers Surefit™ binding system and contoured insoles for a secure fit and better performance. Provide superior traction and stability in slippery conditions. Thermoplastic elastomer won't weigh you down. Specify size: S (men's 6.5-7.5, women's 8.5-10), M (men's 8-10, women's 11+), L (men's 10.5-12) or XL (men's 12.5-14).

Item #	Price
225797	\$37.49

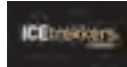

Winter Traction Chains

Comfortable to wear during long hours on the job. Case-hardened steel square links are individually TIG welded to provide reliable traction. Fit a variety of winter footwear. Unisex sizing: S (Men's 5-6, Women's 5-7), M (Men's 6.5-9, Women's 7.5-10), L (Men's 9.5-12.5, Women's 10.5 and up) or XL (Men's 13 and up). NOTE: For uninsulated hiking/work boots, add one size to your shoe size to ensure a proper fit. For oversized/insulated boots, add two sizes to your shoe size to ensure a proper fit.

Item #	Price
225659	\$23.99



Diamond Grip™ Winter Traction Gear

These ICEtrekkers® fit any shoes and boots to give you a reliable, diamond grip when traveling over ice, snow, gravel, rock and mud. Patented "diamond beads" with hundreds of biting edges grip in all directions and are strung on steel aircraft cable. Grips are riveted to a rubber sling that remains flexible in subzero temperatures. Specify size: S (men's 5-6, women's 5-7), M (men's 6.5-9, women's 7.5-10), L (men's 9.5-12.5, women's 10.5 and up), XL (men's 13 and up) or 2XL (men's 13 oversized and up).

Item #	Price
225658	\$43.99



Walk Traction Devices

Feature a traction tread outsole and molded-in, multi-directional, heat-treated steel ice cleats that grip ice, so you can walk naturally on virtually any winter terrain. Easy to put on and take off. Secure fitting for shoes and boots. Fold up to store when not in use. Specify color: black or orange; and size: S (men's 4-7, women's 5-8), M (men's 7.5-10, women's 8.5-12), L (men's 10.5-13) or XL (men's 13.5-16).

Item #	Price	Color
228691	\$14.24	Black
		Orange



Toe Warmers

An adhesive on the bottom of each Heat Factory Toe Warmer allows you to stick it to the bottom of your sock, giving you 6+ hr. of 124°F warmth. Each soft, lightweight toe warmer pouch contains an inert mixture of iron powder, charcoal, salt, water and vermiculite that activate when exposed to air. Odorless and nontoxic. Pkg. of 8 pair.

Item #	Price
214448	\$9.99



Deluxe Boot/Shoe Brush with Scraper

Two 11"L x 6"W V-shaped contour brushes clean all types of footwear with more than 100 sq. in. of sanitary plastic bristles. Plus, with the tip of your toe, you can flip the brushes to expose the steel scraper bar to easily remove accumulations from the sole and instep. One foot secures the unit while the other is being cleaned; or, you can secure the unit through anchor holes provided.

Item #	Price
2900	\$57.99



Mud Chucker™ Boot Scraper

Effectively removes dirt, grass, snow, salt, sand or other debris that should be left outside. Pliable rubber fingertips clean easily. Dirt and debris get shaken off, while melted snow and ice filters down the front and back edges. 100% rubber. 12-3/8"L x 15-1/4"W. Front edge is 1" thick and sides are 2-3/8".

Item #	Price
61628	\$45.99



Boot Scrubber

Removes heavy mud, dirt, grass, sand, snow and debris from footwear. Includes three rows of stiff bristles for maximum cleaning. Heavy-duty steel frame won't bend or break. Can be mounted to any flat service or carried for portable convenience. Protective rubber sleeves protect bolt holes to prevent corrosion. 9.5"W x 7.25"H x 9.5"D.

Item #	Price
230537	\$39.99



Spenco Polysorb® Insoles

Feature a SpenCore® layer that cushions heel and forefoot impact. Cushioning PolySorb® polyurethane supports the arch to fight fatigue and help relieve foot pain. Four-way stretch nylon top cloth reduces shear and friction that cause hot spots and blisters. Specify size: XS (Women's 5-6.5), S (Men's 6-7.5, Women's 7-8.5), M (Men's 8-9.5, Women's 9-10.5), L (Men's 10-11.5, Women's 11-12.5), XL (Men's 12-13.5) or 2XL (Men's 14-15.5).

Item #	Price
222333	\$19.99



NEW Carhartt Insite Insoles

Carhartt footbeds with Insite® Technology are engineered to align the foot in the most natural position. AX™ suede top cover material increases slip resistance and reduces the build up of heat. Provides maximum rebound and distributes foot compression to help prevent fatigue during long work days. Specify Men's whole sizes 8-15.

Item #	Price
CMI9000	\$29.99



Brush-On Boot Protection

Repairs holes in the toe cap of your favorite boots. Brush-on toe protection is easy to use, and it won't crack or peel. It bonds to leather, Cordura®, vinyl and even exposed steel. Keeps out water, barnyard waste and all sorts of debris. Dries overnight. 4.5-oz. jar typically provides enough coverage for three applications. Specify color. Note: not for sale in (AL;GA).

Item #	HM	Price	Color
160318	▲	\$14.99	Black
230055	▲	\$9.99	Brown

▲ Requires special handling due to DOT regulations. Additional shipping charges will apply. Cannot be shipped by air.

Outdoor Lifestyle

You know we've got everything you need to get the job done outdoors, from workwear to safety gear — the best brands, the best prices. But we're not just about workdays. We've got gear for your weekends too. Whether you're partial to hunting, hiking, fishing or just taking it easy, get equipped with Gempler's. Every product tried, tested and approved by us before we offer it to you!

YETI® Tundra 65 Cooler
YTUN65 on pg. 496



NEW

Oakley® Split Shot Polarized Glasses

94160564 on pg. 500



NEW

Carhartt® Pet Hunting/Tech Chore Coat

231143 on pg. 505



NEW

Osprey® Daylite Sling Pack

231093 on pg. 504

YETI®

carhartt

TOP BRANDS

OAKLEY

OSPREY

STANLEY

DUKE CANNON SUPPLY CO.

Coolers..... 496-497
Drinkware & Hydration 498-499
Sunglasses500-503

Packs, Bags & Totes 504
Pet.....505
Personal Care..... 506



YETI Tundra Haul 50 Cooler

Designed and tested by outdoor adventurers!

First-ever YETI cooler on wheels delivers Tundra's legendary toughness and cooling power. Two wheels and a tow handle make it easy to haul, even if you fill it to its 45-can capacity. Rolls easily over sand, grass, rocks and unpaved areas. PermaFrost insulation is commercial-grade polyurethane insulation to keep food, drinks cooler longer. 19-1/2"H x 18-5/8"W x 28-1/4"D. Specify color.

Item #	Price	
YTUNH50	\$399.99	<input type="checkbox"/> White <input type="checkbox"/> Tan <input checked="" type="checkbox"/> River Green <input type="checkbox"/> Charcoal



YETI Tundra 65 Cooler

A bigger hard-sided outdoor cooler for you and your crew, it holds 42 cans of beer or 52 pounds of ice. Rugged Fatwall shell with two inches of Permafrost insulation for pure ice-cold pleasure. 16"H x 30.625"W x 14.75"D.

Item #	Price	
YTUN65	\$349.99	<input checked="" type="checkbox"/> USA MADE



YETI Tundra 35 Cooler

The YETI Tundra® 35 is the right size for personal hauls or food for a small crew. It boasts up to three inches of PermaFrost™ Insulation and a rugged rotomolded construction for optimum performance. 15.375"H x 21.375"W x 13.375"D. Specify color. This Tundra cooler comes with one dry goods basket.

Item #	Price	
YTUN35	\$249.99	<input type="checkbox"/> Charcoal <input type="checkbox"/> Tan <input checked="" type="checkbox"/> White



NEW YETI Tundra 45 Cooler

The YETI Tundra® 45 combines versatility with durability. This premium cooler is infused with legendary YETI toughness — a durable rotomolded construction and up to two inches of PermaFrost™ Insulation. Which is to say it's built to last and will keep your contents ice-cold even in sweltering conditions. No bowing, cracking, or melting here. Specify color.

Item #	Price	
231104	\$299.99	<input checked="" type="checkbox"/> River Green <input type="checkbox"/> Charcoal





YETI Hopper Flip 8 Soft Sided Cooler

The ultimate personal cooler: rugged and waterproof, with amazing cooling power. Wide-mouth opening for easy loading. Detachable shoulder strap, side handles. 8-can capacity. 10.5"H x 11.5"W x 8"D.

Item #	Price	Color
YFLP8	\$199.99	Gray
		Charcoal



YETI Hopper Flip 18 Soft Sided Cooler

They're tough as can be, with a DryHide shell that's waterproof and resists punctures and abrasions. Keep food and drinks colder than ordinary coolers, with closed-cell foam insulation. And lock out moisture with a 100% waterproof zipper. Holds 20 cans of beer, 24 lbs. of ice. 13"H x 16.25"W x 10.75"D.

Item #	Price	Color
YFLP18	\$299.99	Gray
		Charcoal



YETI Hopper Backflip 24 Backpack Cooler

Yeti's first cooler engineered to carry as a backpack, using the best tech of both worlds

Built taller and wider than its Hopper Flip counterparts, Hopper Backflip distributes weight, while ergonomic shoulder straps make the journey comfortable. Removable chest strap and waist belt are included for added stability. Gray or Charcoal.

Item #	Price	Color
YBFLP	\$299.99	Charcoal
		Gray



YETI Camino Carryall 35

The perfect go-anywhere bag. Waterproof and puncture-proof, with a wide mouth opening for easy access. Rugged high-density Thickskin nylon, with waterproof molded EVA base. 14.875"H x 18.125"W x 9.875"D.

Item #	Price	Color
CAMINO35	\$149.99	Storm Gray
		Everglade Sand
		Reef Blue



NEW YETI Hopper M30

Yeti's carry-the-day, tough-as-nails Hopper soft cooler has one big update. They've re-engineered the opening to offer a wide mouth for easy loading and unloading. It closes almost on its own with our HydroShield™ Technology – a strip of ultra-strong magnets – then is secured with two Quick-Release Buckles to ensure it can withstand being tossed around.

Item #	Price	Color
231097	\$299.99	Charcoal
		Navy
		River Green



YETI Hopper Flip 12 Soft Sided Cooler

They're tough as can be, with a DryHide shell that's waterproof and resists punctures and abrasions. Keep food and drinks colder than ordinary coolers, with closed-cell foam insulation. And lock out moisture with a 100% waterproof zipper. Holds 12 cans of beer, 16 lbs. of ice. 11.5"H x 12.625"W x 10"D.

Item #	Price	Color
YFLP12	\$249.99	Charcoal
		Gray



YETI Rambler 20-oz. Tumbler

Made from rugged kitchen-grade stainless steel, with double-wall vacuum insulation keeping drinks colder. MagSlider Lid slides smoothly back and forth and prevents heat or cold from escaping. The magnetic component is not leakproof and will not prevent spills. 6-7/8"H.

Item #	Price
YRAM20	\$29.99

- Navy
- Clay
- Seafoam
- Peak Purple
- Stainless Steel
- River Green
- Black



YETI Rambler 26 oz. Bottle

Rambler Bottles take a licking
Pretty much indestructible, so they're ideal for job sites, truck cab, Bobcat. 18/8 stainless steel, with double-wall vacuum insulation keeping drinks ultra hot or cold. Leakproof TripleHaul cap with handy 3-finger grip. 10.25"H x 3.375"W.

Item #	Price
YRAM26	\$39.99

- Silver
- Clay
- Black
- Peak Purple
- Navy
- River Green
- Seafoam



YETI Rambler 30 oz. Tumbler

Bash 'em, bang 'em - you can't hurt these 18/8 stainless steel tumblers. Double-wall insulation keeps cold drinks cold, hot drinks hot to the last sip. While the magnet on the included MagSlider™ Lid adds an additional barrier of protection for keeping drinks contained and preventing heat or cold from escaping, please note - this magnet component is not leakproof and will not prevent spills. 7.875"H x 4"W. Base is 2.75"W and Top is 4"W.

Item #	Price
YRAM30	\$34.99

- Seafoam
- Clay
- Silver
- Peak Purple
- Black
- River Green
- Navy



YETI Rambler 14 oz. Mug

Tough-as-nails Rambler Mug
Bash 'em, bang 'em - you can't hurt these 18/8 stainless steel, camp-style mugs. Double-wall insulation keeps cold drinks cold, hot drinks hot to the last sip. Full loop TripleGrip handle is comfortable for bigger hands. 3.75"H x 5"W. Do not place mug over external heat source or open flame. Vacuum seal or other damage may occur.

Item #	Price
YRAM14	\$24.99

- Black
- Navy
- Seafoam
- Silver



YETI Rambler 18 oz. Bottle

Rambler Bottles take a licking
Pretty much indestructible, so they're ideal for job sites, truck cab, Bobcat. 18/8 stainless steel, with double-wall vacuum insulation keeping drinks ultra hot or cold. Leakproof TripleHaul cap with handy 3-finger grip. 9.5"H x 3"W.

Item #	Price
YRAM18	\$29.99

- Silver
- Seafoam
- Navy
- Black
- Clay
- Peak Purple
- River Green



YETI Rambler 1 gal. Jug

If you work outside when it's broiling hot, you better drink plenty of water. These jugs make sure you do. They'll keep liquids icy cold (or hot) not just for hours, but for days. Yeti's trademark tough 18/8 stainless steel, with double-wall vacuum insulation, leakproof cap, much more. Stainless. 12.375"H x 6.375"W.

Item #	Price
YRAM1G	\$129.99



Stanley® A Brand Of PMI Classic One-Hand Vacuum Mug

Fits most vehicle cup holders

Thermal push button lid is easy to open with one hand and disassembles for deep cleaning. Mug is double-wall vacuum insulated and leak proof. BPA free and dishwasher safe. Green. 16-oz.

Item #	Price
230965	\$21.00



Stanley® A Brand Of PMI Classic Vacuum Bottle

Insulated lid doubles as a cup

There's a reason Stanley kept this bottle simple and classic: don't fix what ain't broken. Double wall vacuum insulated with a locking handle. BPA free. Green. 1.4-qt. capacity.

Item #	Price
230961	\$33.75



Stanley® A Brand Of PMI Classic Vacuum Food Jar

Makes soup portable again

Perfect for your next outdoor adventure. Double wall insulation with an insulated lid. BPA free. Green. 24-oz. capacity.

Item #	Price
230963	\$30.00



Stanley® A Brand Of PMI Classic Vacuum Pint

Don't leave home without it

Perfect for your favorite beer, soda or coffee. Double wall vacuum insulation. 18/8 stainless steel. BPA free. Green. 16-oz. capacity.

Item #	Price
230969	\$17.25



Stanley® A Brand Of PMI Master Flask

Stainless-steel interior won't retain flavors or smells

Features a convenient, wide mouth for easy filling and pouring. BPA free and dishwasher safe. Black. 8-oz. capacity.

Item #	Price
230973	\$26.25



Stanley® A Brand Of PMI Adventure Cooler

Keeps things cool 40% longer than a typical cooler

Foam insulated lid and body. Keeps your lunch cool and fresh, even if you end up eating it on the way home. BPA free. Green. 13"L x 11"W x 8-1/2"H. 7-qt. capacity.

Item #	Price
230978	\$37.50



NEW



Flak 2.0 XL

Standard size frame with enhanced lens coverage. Optimized with High Definition Optics™ in a durable yet lightweight design that takes performance and style to the next level.

Item #	Color	Frame Color	Price
91888659	Prizm Ruby	Black Camo	\$176.00
91887359	Prizm Black	Matte Black	\$176.00
9188C859	Prizm Jade	Matte Black	\$196.00
91885859	Prizm Deep Water Polarized	Matte Black	\$206.00
91887259	Prizm Black Polarized	Polished Black	\$206.00





NEW



Gascan

We traded soft curves for straight edges and hard lines to sculpt our very first high-wrap lifestyle shades. The toric lens design became known as Gascan™.

Item #	Color	Frame Color	Price
90144460	Prizm Ruby	Polished Black	\$136.00
90144360	Prizm Black	Matte Black	\$136.00
12	Black Iridium Polarized	Matte Black	\$156.00

-  Matte Black
-  Black Iridium Polarized
-  Polished Black
-  Prizm Ruby
-  Prizm Black



NEW



Split Shot Polarized

The ultimate eyewear for the waterman, this hat-compatible, high wrap frame with a detachable leash gives you a wide view of the world that's designed to block glare.

Item #	Color	Frame Color	Price
94160564	Prizm Shallow Water Polarized	Polished Black	\$216.00
94160664	Prizm Deep Water Polarized	Matte Black	\$216.00
94160864	Prizm Ruby Polarized	Matte Heather Gray	\$216.00



NEW



Half Jacket 2.0 Polarized

If you're trying to keep up with the competition, you need to keep up with changing light. We engineered Half Jacket 2.0 to let you swap out the lenses with ease.

Item #	Frame Color	Color	Price
91440162	Polished Black	Black Polarized	\$136.00



NEW

**Holston**

A proud salute to the Oakley design original known as Jupiter Squared, Holston takes a clean, modern approach to the classic styling of rectangular shaping.

Item #	Color	Frame Color	Price
93340858	Prizm Grey	Black	\$136.00
93341158	Prizm Black Polarized	Dark Gray	\$186.00



NEW

**Holbrook**

Inspired by the screen heroes from the 1940s, 50s, and 60s, this design epitomizes the spirit of exploration and adventure. The iconic American frame design is accented by metal rivets and Oakley icons.

Item #	Color	Frame Color	Price
9102E955	Prizm Ruby	Black Camo	\$156.00
9102M155	Prizm Black	Matte Black	\$176.00
9102F055	Prizm Sapphire Polarized	Matte Black	\$186.00
9102B755	Prizm Daily	Woodgrain	\$186.00



NEW

**Silver Edge**

Smooth curvature that extends the peripheral range of view. The side-to-side contour adds to the sleek styling of sculptural lines, and with its architecture of thin cross sections, the frame is comfortably lightweight.

Item #	Color	Frame Color	Price
94130265	Prizm Ruby	Matte Black	\$156.00



NEW

**Mainlink XL**

Unobtainium™ is integrated into the classic styling of this OMatte™ frame inspired by Oakley™ Crosslink™, blending sculpture with versatility that keeps up with active lifestyles.

Item #	Color	Frame Color	Price
92644561	Prizm Black Polarized	Matte Black	\$206.00
92644761	Prizm Deep Water Polarized	Polished Black	\$206.00

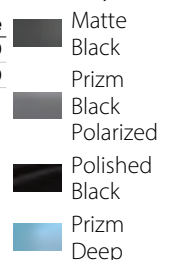



NEW

Daylite Sling Pack

Great when you're on the move - just sling it over your shoulder and go. Tough ripstop nylon, with roomy zippered compartment and adjustable strap. Black, Amulet Purple, Petrol Blue.

Item #	Price
231093	\$40.00



NEW

Daylite Waist Pack

A wallet or purse just isn't as secure as this pack you strap to your waist - especially if you're wearing lightweight hiking, bicycling or travel shorts. Tough rip-stop nylon, with zippered compartment and adjustable strap.

Item #	Price
231094	\$30.00



NEW

Daylite Plus Backpack

The Daylite Plus features a removable foam frame sheet suspension, with a center stiffener allowing dynamic body movement. The mesh-covered die cut foam panel allows for additional comfort and ventilation. The Daylite Plus is lightweight, durable and comfortable... the perfect pack for traveling!

Item #	Price
231245	\$65.00



Legacy Work Pack

Roomy, water-repellent backpack with a reinforced base

Work, travel, outdoor rec - this pack does it all. Tough 1200-denier polyester, with Rain Defender® finish, zip main compartment, two pockets front and sides. Contoured shoulder strap and padded air mesh back panel for comfortable carrying. 12" x 18" x 11". Specify Color: Black, Carhartt Brown or Gray.

Item #	Price
190231	\$69.99



Legacy North South Tote

Water-repellent tote keeps gear dry in light rain

No fancy pants tote - just load it up with your work gear and toss it in the truck. Main compartment holds laptop, file folders, books, while two side pockets and inner organizer handle the small stuff. Tough 600-denier polyester with Rain Defender® finish. Snap closure. 15-1/2" x 14" x 5-1/2". Specify Color: Black or Carhartt Brown.

Item #	Price
131121	\$49.99



NEW

Women's Hybrid Backpack

This women's versatile bag can be worn as a backpack or slung over your shoulder as a tote. Well-suited for your daily commute, the top-loading main compartment includes a padded pocket for your laptop. It also has two drop-in pockets plus an outer zip pocket for the small stuff. Rugged and water-repellent, this hybrid pack is designed to shrug off dirt, stains, and light rain. Specify Color: Black, Carhartt Brown or Wine.

Item #	Price
137901B	\$54.99



NEW



Hunting/Tech Chore Coat

It's Carhartt's classic cotton canvas duck, with a water-repellent coating to keep your dog dry in wet, windy weather. Quilted liner adds warmth, while improved tabs at the neck and chest make it easy to get on and off. Corduroy collar, two pockets for treats, poop bags, etc. Sizes S-XL. Specify Size and Color: Black, Army Green, Carhartt Brown or Hunter Orange.

Item #	Size	Price
231143	S-XL	\$39.99



NEW



Journeyman Leash

Reflective triple-needle stitching and Carhartt word-mark for low-light safety. You can work the metal claw clasp even with gloves on and the metal D-ring slides up and down for attachment options. Perfect for hardworking dogs. 6' long. Carhartt Brown. Specify Size Small or Large.

Item #	Size	Price
231142	S-L	\$29.99



NEW



Walking Harness

This rugged on-leash training harness is built with two attachment points: one on the back for everyday walks and one on the chest for increased control, that helps you work against pulling. Nylon webbing has reflective triple stitching for low light visibility. Cushioned for comfort. Sizes based on dog chest girth. Sizes S-XL. Specify Size.

Item #	Size	Price
231147	S-XL	\$39.99



NEW



Shock Absorbing Control Leash, Carhartt Brown

Training a rambunctious pup can be tiring, but this leash makes it easier. It has an elastic shock-control zone for greater flexibility, a lined handle for comfort and a bottom handle for sure control. Rugged nylon webbing, with reflective triple stitching for low-light visibility for late night walks with your dog. You can work the metal trigger claw clasp even with gloves on. One Size.

Item #	Price
231149	\$29.99



NEW



Lighted Collar

If you walk your dog after dark, this is the ultra-bright collar you need. It has a 3-mode, red LED light built in to the quick-release buckle and the battery is easily replaceable. Rugged nylon webbing, fully adjustable, with reflective triple-needle stitching and slotted metal D-ring to hold license and tags. Specify Size M or L.

Item #	Size	HM	Price
231140	M-L	▲	\$19.99

▲ Requires special handling due to DOT regulations. Additional shipping charges will apply. Cannot be shipped by air.



NEW



Pet Beds

Made from the same tough cotton duck as the Carhartt jackets and bibs you wear, for a lifetime of use. Washed so it's an immediately comfy resting place. When your dog gets it dirty, just zip off the cover and wash it clean. 12 oz. cotton canvas duck with water-repellent coating. Specify Color and Size: Carhartt Brown or Dark Brown.

Item #	Size	Price
231136	L	\$119.00
231135	M	\$99.99

DUKE CANNON SUPPLY CO.

In a world of weak handshakes, here's a finger-crushing introduction

NEW

USA MADE

Duke Cannon's purpose is simple: to make superior-quality grooming goods that meet the high standards of hard-working men. Our products are tested by soldiers, not boy bands. And they're made in a little place we like to call the United States of America.



Bloody Knuckles Hand Repair Balm
Item #193144 \$8.99



Grunt Powder Foot and Boot Spray
Item #193148 \$8.99



Trench Warfare Dry Ice Foot Powder
Item #193142 \$8.99

Cannon Balm
\$40 Lip Balm - \$25.13
Item # 193147 \$6.99



Big American Bourbon Soap
Item #193146 \$6.99



Antiperspirant & Deodorant - Sandalwood & Amber
Item #193161 \$7.99



Antiperspirant & Deodorant - Bergamot & Black Pepper
Item #193160 \$7.99



Big Ass Beer Soap
Item #193145 \$6.99

Cold Showers Cooling Field Towels - 25 ct.
Item #193150 \$6.99





Footwear
Pages 461-494

Footwear

Accessories

Boot Dryers	491
Brushes & Repair	492-494
Foot Care.....	492
Insoles & Liners.....	494
Shoehorns	492
Traction Devices	485, 493
Trays & Racks.....	492

Boots & Shoes

Overboots.....	484-485
Rubber/PVC Boots	476-482
Winter Boots	483
Work Boots & Shoes	462-475

Socks

Ankle.....	487
Boot.....	487-490
Compression	490
Crew	487-490
Waterproof	490

Waders

Chest.....	486
Hip.....	486



Landscape & Nursery Supplies
Pages 155-276

Landscape & Nursery

Brush Clearing

Chainsaw Clothing & Accessories	216-219
Controlled Burn Equipment	220-221
Tools & Accessories.....	215

Equipment

Carts & Wheelbarrows.....	200-205
Fences & Trellises	199
Gardening Hand Tools	
Composting.....	198
GPS System.....	213
Lawn Rollers & Aerators	210
Lawn Sweepers	210-211
Mower Accessories	214
Scales	212-213
Spreaders.....	206-209
String Trimmer Racks.....	168, 214
Plant Covers & Frost Protection..	199

Landscape Tools & Supplies

Edging & Accessories	161
Hardscape Accessories	163
Hoes & Cultivators	178-179
Landscape Fabric & Anchors	156-160
Lawn Sweepers.....	210-211
Leaf & Trash Pickup.....	164-167
Mulch	162-163

Landscape Tools & Supplies cont.

Pitchforks	180
Post Hole Diggers & Augers	172
Rakes.....	181-182
Scrapers.....	171
Spades & Shovels	173-177
Tool Racks & Hooks	168-171

Marking Supplies

Flagging Tape	238-240
Marking Flags	236-237
Plant Markers & Tree Tags ..	230-235

Pruning Equipment

Grass & Hedge Shears.....	183
Hand Pruners	186-193
Loppers	184-185
Pruning Saws	195-197
Scissors	193
Telescoping Pruners & Saws	194-195

Snow & Ice Removal

Scrapers.....	171
Ice Melter	276
Shovels	275
Spreaders & Sweepers	208-209

Surveying Supplies

Clipboards	243
Measuring Tapes & Devices	240-242
Surveying Accessories	240-242

Table of Contents



Landscape & Nursery Supplies
Pages 155-276

Tree & Plant Care

- Tree & Plant Irrigation 228-229
- Tree & Shrub Fertilizers..... 227
- Tree Stakes & Anchors..... 222-225
- Tree Wraps & Guards..... 199, 226

Turf Management

- Moisture Meters251-253
- pH, EC & TDS Meters 250-251
- Refractometers..... 251
- Soil, Water & Nitrate Testing 244-249

Watering & Irrigation

- Hose Storage..... 264
- Irrigation 267
- Nozzles & Wands..... 260-263
- Pump 267
- Sprinklers & Timers..... 265
- Valves..... 266
- Water Hoses 256-260
- Watering Cans 267

Weather Monitoring

- Rain Gauges 271
- Temperature & Humidity ...270, 272
- Windsocks & Weathervanes..... 268



Outdoor Lifestyle
Pgs. 495-504

Outdoor Lifestyle

- Coolers 496-497, 499
- Drinkware & Hydration.....498-499
- Packs, Bags & Totes502
- Pet..... 503
- Sunglasses..... 500-501



Outdoor Lifestyle
Pgs. 495-504



Outdoor Lifestyle
Pgs. 495-504



Pest Management
Pages 277-306

Pest Management

Animal Repellents & Live Traps

- Animal Repellents..... 287-290
- Live Traps 291

Bird & Goose Control

- Bird Netting & Fencing284-286
- Bird Repellents 278-284
- Decoys 280-281
- Flash Tape & Scare Balloons 284
- Live Traps 291
- Pyrotechnics..... 279

Insect Control

- Insect Repellents..... 298, 300-303
- Insect Traps300-302, 304-305
- Pheromone Lures.....304-305
- Sweep Nets..... 306

Mole & Gopher Control... 292-295

Netting & Fencing

- Fencing.....285-286
- Netting 285

Rodent Control

- Rodent Bait & Bait Stations..... 296-297
- Rodent Traps & Glue Boards..... 297-298

Snake Control

- Snake Repellents..... 299
- Snake Tongues & Protection 299



Safety Supplies · Pgs. 22-109

Safety Supplies

Chemical Storage & Handling

- Safety Cabinets92
- Spill Cleanup & Sorbents.....93-95

First Aid & Emergency Response

- Decontamination Supplies.....77
- Eye Wash Supplies55-57
- Fire Safety Supplies 109
- First Aid Supplies 86-89
- Hydration & Drinkware..... 84-85
- Sunscreen 90

Personal Protective Clothing & Equipment

- Eye Protection.....43-53
- Head Protection78-79
- Hearing Protection 58-65
- Nitrile & Chemical Gloves.....23-30
- Pesticide Safety Kits76
- Protective Clothing.....66-75
- Respiratory Protection.....31-42

Signs, Labels & Traffic Control

- Barricades97
- Markers..... 99
- Signs.....96, 100-102, 104
- Traffic Cones & Accessories 96-99

Worker Safety & Compliance

- Globally Harmonized System.... 103
- OSHA Record Keeping 103

Worker Safety & Compliance cont.

- Right to Know Compliance..... 103
- WPS Resources 105-108



Shop Supplies Pgs. 307-391

Shop Supplies

Brooms, Mops & Brushes

- Brooms 309, 315-316
- Brushes.....308, 318
- Buckets & Dustpans.....309, 317, 329
- Mops & Squeegees.....317

Clean Up Supplies

- Garbage Bags.....319
- Hand Cleaners 320
- Industrial Cleaners & Detergents.....321
- Shop Towels & Wipes..... 320
- Waste Cans 310, 319

Facility Supplies

- Air Hoses & Tools..... 328
- Anti-Slip Tape..... 327
- Curbs, Posts & Guards 326
- Disinfectant Mats 323
- Floor Matting 323-325
- Generators..... 322
- Lighting & Electrical 330
- Pails, Tubs & Totes 329
- Park & Rec Supplies 333
- Property Markers 332
- Security331
- Stools & Creepers..... 327
- Transfer Pumps..... 329, 343-345
- Wraps & Tape 312-313, 382

Fencing Tools & Supplies

- Come Alongs..... 384
- Fence Repair.....384-385
- Fence Tools & Supplies 385
- Post Drivers & Pullers 383
- Snow & Utility Fencing 386

Fuel Storage & Lubrication

- Fuel Cans..... 338-341
- Fuel Transfer Pumps & Tanks..... 343-345
- Funnels..... 342
- Grease Guns & Supplies.....346-348
- Meters..... 345

Hand Tools & Supplies

- Bolt Cutters..... 389
- Knives & Multi Tools 387
- Pry Bars & Hammers..... 389
- Sharpeners 387
- Tool Belts, Boxes & Bags.....390-391
- Wrenches, Sockets & Tool Sets . 388
- Zip, Twist Ties & Bungee Cords..... 379-381

Table of Contents



Shop Supplies Pgs. 307-391



Shop Supplies cont.

Rust Control

Paint	363
Rust Converters & Removers	360-362
Rust Preventers	362

Storage & Material Handling

Bins & Bin Storage.....	334
Drums & Accessories.....	337
Storage Bags	335-336

Tarps, Ropes & Tie Downs

Bungees	380-381
Ropes	378
Stretch Wrap	382
Tarps.....	373-374
Tie-Downs	376-377
Wraps & Tape	312-313, 382

Tire Repair & Supplies

Air Gauges & Chucks	359
Assemblies & Rims.....	356-357
Flat Tire Prevention	349-351
Jacks.....	358
Liquid Ballast Supplies.....	355
Repair Supplies.....	352
Tire Bead Tools	353-355

Vehicle & Tractor Accessories

Cab Filters	366-367
Cables, Chargers & Testers.....	372
Dualing Parts	370
Hitches.....	370
Lights	371
Oil Changing Supplies	364
Tractor Canopies	365
Towing.....	368-369



Sprayers & Parts Pgs. 110-154

Sprayers

ATV & Spot Sprayers.....	127-129
Backpack Sprayers	113-123
Handheld Sprayers	113-115, 118, 124-126
Skid Sprayers.....	128-129, 135-138
Three-Point Sprayers	133-134, 136-137
Trailer Sprayers	130-132

Measuring & Calibration

Chemical Measuring	152-154
Sprayer Calibration	149

Sprayer Parts & Accessories

Defoamer, Colorants & Drift Retardants	145-146
Spray Guns, Hoses & Reels	126, 140-141, 144
Sprayer Parts	111-112, 117, 144
Sprayer Pumps & Tanks	142-144
Sprayer Rinsing.....	145-146

Workwear

Accessories

Aprons & Shop Coats	412
Belts & Suspenders.....	411
Headwear.....	408-410

Base Layer

460

Bibs & Coveralls

Bibs.....	455-457
Coveralls.....	458-459

Gloves

Accessories	407
Coated	400-405
General Purpose.....	399-405
Leather	393-398
Mechanics.....	399, 406

Outerwear

Coats & Jackets	429-434
Vests & Safety Vests.....	435-436

Pants & Shorts

Jeans & Pants	448-453
Shorts.....	453-454

Rainwear

Coats & Jackets	415-427
Pants & Bibs.....	415-427
Ponchos & Slickers.....	428
Suits.....	413-414, 418-419

Shirts & Sweatshirts

Button Up Shirts.....	430-431, 440-441
Polo Shirts.....	442
Pullover Shirts.....	442
Sweatshirts.....	437-439
T-Shirts.....	443-447



Workwear • Pages 392-460

PROBLEM SOLVERS

better products for working faster, smarter and safer

Best Value with premium features

GEMPLER'S

Gempler's Rain Jacket and Bib Overalls combination is the ultimate in rain gear. Rainsuit is constructed of rugged, .20mm PVC-on-nylon material with a second layer on the elbows and knees for added durability.

Item #	Description	Color	Price
167460	Jacket w/ Pants	Green	\$44.99
167461	Jacket w/ Bibs	Green	\$44.99
167462	Jacket w/ Bibs	Yellow	\$44.99
224317	Jacket w/ Bibs	Blue	\$44.99

167460
Green with
Pants



Elastic waist with drawstring and stay-tight clasp

Reinforced elbow and knee patches

A difference you can see and feel

GEMPLER'S PVC

Lightweight and flexible, plus it won't stick to your skin



Quality, tightly woven fabric is coated with just the right amount of PVC

TYPICAL PVC

Heavy, inflexible material sticks to your skin when you sweat



Loosely woven fabric is flimsier and requires more PVC to compensate for less strength

167462
Yellow
with Bibs



224317
Blue
with Bibs



Cheap tarps driving you mad? It's time to get Weather Tough.

Weather Tough tarps combine the best traits of polyester and canvas construction into one high-quality "super tarp." Rugged, 14.5-oz. polyester/canvas-blend tarps are waterproof like poly and breathable like canvas. Feature brass spur grommets approximately 2' apart on all sides that don't rust or tear out like standard grommets. **NOTE:** Actual finished tarp size may vary by up to 6" due to manufacturing process.

Item #	Size	Price
219367	3' x 6'	\$24.99
219368	4' x 4'	\$16.49
219369	4' x 8'	\$37.49
219370	6' x 8'	\$46.49
219371	8' x 10'	\$68.99
219372	8' x 12'	\$82.49
219373	10' x 12'	\$104.99
219374	10' x 20'	\$172.99

BLACK OR GRAY

Item #	Size	Price
227089	3' x 6'	\$28.49
227090	4' x 4'	\$18.99
227091	4' x 8'	\$38.49
227092	6' x 8'	\$56.99
227093	8' x 10'	\$74.99
227094	8' x 12'	\$99.99
227095	10' x 12'	\$124.99
227096	10' x 20'	\$199.99



Breathable fabric prevents moisture damage

From Back Cover : ID No. _____ Keycode No. _____

ORDERED BY: (Please print)

SHIP TO: (Only if different from ORDERED BY)

Name: _____
Company (if any): _____
Street Address: _____
City: _____ State: _____ Zip: _____
Daytime Phone: (_____) _____
Email Address: _____

Name: _____
Company (if any): _____
Street Address: _____
City: _____ State: _____ Zip: _____
Daytime Phone: (_____) _____
Email Address: _____

PAYMENT INFORMATION:

MasterCard Check Enclosed (payable to Gempler's)
 VISA SmartPay
 DISCOVER Card
 American Express

Card Number _____ Security Code _____ Expiration Date (MM/YY) _____
Signature: _____

ORDER INFORMATION:

Item #	Color/Size	Qty.	Page No.	Description	Price Each	Total

STANDARD SHIPPING RATES: Rates (shown at right) apply to standard ground shipping for orders within the contiguous 48 states that meet FedEx weight and dimension standards. For deliveries outside the 48 contiguous states, actual shipping charges will apply. Some items require motor freight and will be billed as actual freight—charges to be determined when order is placed.

SALES TAX:
GEMPLER'S is required to charge state and local tax on items shipped to addresses within the following state(s): **AL, AR, AZ, CA, CO, CT, GA, HI, IA, ID, IL, IN, KS, KY, LA, MA, MD, ME, MI, MN, MS, NC, ND, NE, NJ, NM, NV, NY, OH, OK, PA, RI, SC, SD, TX, UT, VA, VT, WA, WI, WV, WY.**
If applicable, please provide sales tax exemption certification and clearly state which items are tax exempt.

Purchase Total	Shipping Charge
\$00.01 – 29.99	\$9.95
\$30.00 – 49.99	\$20.99
\$50.00 – 99.99	\$25.99
\$100.00 – 149.99	\$30.99
\$150.00 – 199.99	\$35.99
\$200.00 – 299.99	\$40.99
\$300.00 – 399.99	\$45.99
\$400.00 – 499.99	\$50.99
\$500 and up	\$55.99

Merchandise Total: (Determines shipping charge)	
Shipping Charges: (See chart at left)	
Subtotal:	
Sales Tax: (Where applicable)	
Grand Total: <i>Thank you!</i>	

TERMS AND CONDITIONS:

Prices: Prices listed do not include freight or taxes and are subject to correction or change without notice. Market sensitive commodity products will be priced according to current market conditions. Customer should check online at gemplers.com for current pricing and shipping or call Customer Service at 1-800-382-8473. Gempler's Inc. reserves the right to accept or reject any order. Promotional offers and discounts do not apply to Gempler's Shipping Saver and Clearance items.

Payment Terms: Master Card, Visa, American Express, Discover, SmartPay accepted. COD payments are not accepted.
Terms: By placing an order, customers accept and agree to Gempler's Inc. Terms and Conditions.
A full statement of Gempler's Inc. Terms and Conditions is available at gemplers.com/pages/orders-shipment-returns and is incorporated by reference.

You choose – get a **FREE GIFT** with your qualifying order!

At Gempler's, we always treat you like a neighbor and not a number. This free gift offer is our way of saying thanks for trusting us with your order.

For **ONLINE** orders

Add the **FREE GIFT** item to your cart and apply the corresponding Discount Code before you checkout.

Tell your Customer Service Rep. the **FREE GIFT** item you'd like to add to your order and the corresponding Discount Code.

For **PHONE** orders



Carhartt® Trifold wallet features six card pockets and two side pockets. Gift tin may vary.
FG228036 Retail \$14.99
Discount Code: **37FGWLT**



Duke Cannon Big Ass Beer Soap smells like woody, sandalwood, and suds up like the beer that is in its name, while **Duke Cannon Bloody Knuckles Hand Repair Balm** is a non-greasy, unscented lanolin-based balm, containing no blood, just relief for your dry cracked knuckles.

FG230894 Retail \$16.98
Discount Code: **37FGSOP**

PICK YOUR GIFT WITH ELIGIBLE \$150+ ORDER*

FREE GIFT OFFER DETAILS

- Your order must meet the minimum purchase value before adding the **FREE GIFT**. Minimum purchase value excludes tax and shipping charges.
- Limit one **FREE GIFT** per qualifying order, while supplies last.
- Offer expires 2/29/20 and does not apply to previous purchases and cannot be combined with any other discount or promotion.
- Government employees are not eligible for free gift offers. Void where prohibited.

FREE GIFTS

Classic Stanley® Thermal Mug keeps drinks hot or cold for 7 hours or iced for 30 hours. 16 oz.
FG230965 Retail \$28
Discount Code: **37FGMUG**

Carhartt Case® Lock Blade Pocketknife has a locking 2-1/2" L stainless steel blade. 6-5/8" L open. 3-3/4" L closed.
FG228109 Retail \$26.99
Discount Code: **37FGKNF**

Ultra-bright 272 lumen
Mag-Lite® 2-AA LED Flashlight has a rugged aircraft-aluminum case and runs for 2.5 hours on your batteries. 6-5/8" L.
FG227755 Retail \$24.99
Discount Code: **37FGLGT**

Hori-Hori Digging Tool's 6 3/4" L rustproof digging blade knows its way around the garden. 11-7/8" L tool.
228503 Retail \$21.99
Discount Code: **37FGHOR**

PICK YOUR
GIFT
WITH ELIGIBLE
\$200+ ORDER*

PEET® Power Cell Boot Dryer warms and dries your boots to help eliminate odors caused by perspiration and bacteria.
FG8P425 Retail \$19.99
Discount Code: **37FGDRY**

2-PACK Retractable Ratchet Straps have a 500-lb. working-load limit. 6' L x 1" W.
217122 Retail \$22.99
Discount Code: **37FGRTC**

Ironclad® Touchscreen Utility Gloves are durable, breathable and feature touchscreen capability. Men's Large only.
FG218903-L Retail \$19.95
Discount Code: **37FGGLV**

Bucket Boss® Bucketeer Tool Organizer turns your 5-gal. bucket into a super storer that can stand up to hard use.
230879 Retail \$19.99
Discount Code: **37FGBKT**

1-gal. Gatorade® Personal Water Cooler keeps your beverages cold and resists impact like a champ.
83933 Retail \$20.99
Discount Code: **37FGBEV**

***SEE PAGE 511 FOR OFFER DETAILS**

FREE GIFTS



Merino Wool blend **Darn Tough® William Jarvis Full-Cushion Socks** are breathable and comfortable. Men's Large only.
FG231000L Retail \$25.00
Discount Code: **37FGSCK**

Bucket Boss® Gatemouth Tool Bag opens wide and features 16 pockets to keep your tools organized. 16"W x 12"H x 9"D.
FGBB11 Retail \$45.99
Discount Code: **37FGBAG**



Channellock® 16-pc Pass-Thru Socket Set fits 42 different styles and sizes of fasteners, both SAE and Metric.
230147 Retail \$41.59
Discount Code: **37FGSKT**

DeWalt® 45-pc Screwdriving Bit Set are ideal for use in a drill driver and feature a magnetic drive guide.
DW2166 Retail \$39.99
Discount Code: **37FGSCW**



Classic Stanley® Thermal Mug keeps drinks hot or cold for 28 hours or iced for 150 hours. 1.4-qt.
230961 Retail \$45.00
Discount Code: **37FGVAC**

Sync™ MP3-Compatible Earmuffs plug in your portable device so you can listen to what you'd like, with no batteries needed. 25dB NRR.
198387 Retail \$39.99
Discount Code: **37FGMUF**



DeWalt 21-pc Titanium Pilot Point Drill Bit Set features a patented point tip that starts on contact.
DW1361 Retail \$44.99
Discount Code: **37FGDRL**

PICK YOUR
GIFT
WITH ELIGIBLE
\$400+ ORDER*

*SEE PAGE 511 FOR OFFER DETAILS

FREE GIFTS



Rechargeable LED Work Light functions as both a flash light and a floodlight with 185 lumens total output. Measures 11.5"L and weighs 12 oz.
216495 Retail \$49.99
Discount Code: **37FGLMP**

Stanley® Adventure Cooler Keeps food and drink cold for 27 hours. 13"L x 11"W x 8-1/2"H. 7-qt. capacity.
230978 Retail \$50.00
Discount Code: **37FGCLR**

PICK YOUR
GIFT
WITH ELIGIBLE
\$500+ ORDER*



PICK YOUR
GIFT
WITH ELIGIBLE
\$600+ ORDER*

Peet® Boot Dryer with Glove Dryer Accessory features thermal convection drying to prevent shrinkage, stiffness and damage to your leather gloves and footwear.
21863 Retail \$54.99
Discount Code: **37FGDRG**



Multi-Angle and Swivel LED Work Light produces 2,200 lumens, yet remains cool to the touch. 6'L power cord.
227155 Retail \$61.49
Discount Code: **37FGLED**



*SEE PAGE 511 FOR
OFFER DETAILS

PICK YOUR GIFT WITH ELIGIBLE \$800+ ORDER*



Work Sharp® Knife and Tool Sharpener lets you restore knife and tool blades yourself saving you time and money.
176955 Retail \$84.99
Discount Code: **37FGSHP**



Crescent 70-pc. Tool Set is convenient, compact and loaded with tools to keep your equipment in running order.
230298 Retail \$85.99
Discount Code: **37FGCRS**



Transport your tools in style with the **Bucket Boss® Sling Pack Tool Organizer** featuring an impressive, 15L of storage space and heavy-duty, 1680 poly fabric that won't rip, tear or puncture.
230888 Retail \$109.99
Discount Code: **37FGORG**

PICK YOUR GIFT WITH ELIGIBLE \$1000+ ORDER*



LEATHERMAN® Wave+ Multi-Tool provides you with 17 tools in one. 100% stainless steel won't rust or corrode. Includes black nylon sheath.
123530 Retail \$99.95
Discount Code: **37FGMLT**

*SEE PAGE 511 FOR OFFER DETAILS

TO ORDER: GEMPLERS.COM
or 800-382-8473

When you order, include your ID No. and
Keycode No. (shown in the boxes below)
to save you time and make ordering easier.

ID No.

Keycode No.

If you would like to be removed from
this mailing, please email us at
customerservice@gemplers.com.

GEMPLER'S, P.O. Box 5175, Janesville, WI 53547-5175
© 2020 Gempler's Inc.
Printed in the USA. 3701

GEMPLER'S®
P.O. Box 5175
Janesville, WI 53547-5175

OR CURRENT OCCUPANT

PRESORTED
BOUND PRINTED MATTER
U.S. POSTAGE PAID
GEMPLER'S INC.

KINCO SPECIAL BUY on gotta-have gloves!

Hydroflector Lined Double-Coated Gloves, only \$5.99. The cure for cold, wet hands. Smooth latex coating provides a flexible waterproof barrier to keep entire hands warm and dry. Black sandy latex palm coating stays supple in low temps, offers abrasion protection and increases grip control in liquids. *Specify color: lime or orange.*

Hydroflector Cowhide Driver's Gloves, only \$9.99 - \$11.99. The classics you've trusted for years, in premium full-grain leather. They provide excellent protection in wet conditions and guard against punctures and abrasions. Easy-On cuff with shirred elastic wrist for comfort and quick on/off. Ergonomic keystone thumb design for flexible, full range of motion and less hand fatigue. *Available unlined or lined.*



NEW

Coated Suggested Use

- Irrigation & Pipe
- Marine & Fishing
- Recycling & Waste Management
- Snow & Ice Removal

40% off

Get great gloves at
an economical price

**Special
Buy**

Leather Suggested Use

- Construction & Hardware
- Farm & Ranch
- Material Handling

Style	Sizes	Item #	Was	NOW
Lime Coated	Men's M-XL	193220	\$9.99	\$5.99
Orange Coated	Men's M-XL	193440	\$9.99	\$5.99
Unlined Leather	Men's M-2XL	231171	\$16.99	\$9.99
Lined Leather	Men's M-XL	231173	\$19.99	\$11.99

GEMPLER'S is your glove headquarters [Shop
gemplers.com](http://Shop.gemplers.com)