

### Parts List - Underbed, MidLine & LoLine Drawers

Note: All of our Drawer Boxes assemble using the same steps, different parts.

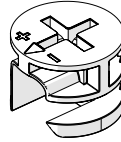

#### PINS

*Underbed - x36*  
*LoLine - x36*  
*MidLine - x60*

#### CAMS

*Underbed - x36*  
*LoLine - x36*  
*MidLine - x60*

#### MEASURING TUBE

*Underbed - x1*  
*LoLine - x1*  
*MidLine - x1*

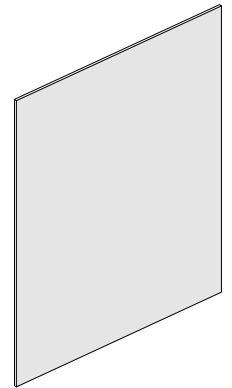
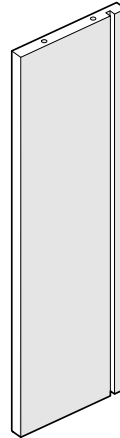
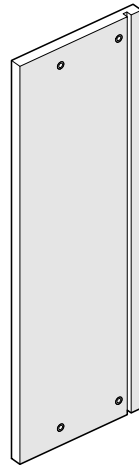
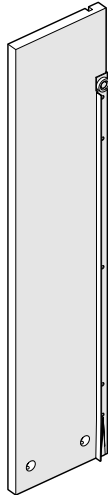
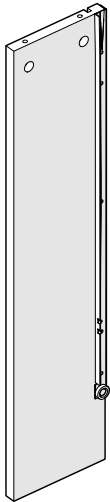

#### DRAWER LEFT WALL

*Underbed - x3*  
*LoLine - x3*  
*MidLine - x5*

#### DRAWER RIGHT WALL

*Underbed - x3*  
*LoLine - x3*  
*MidLine - x5*

#### DRAWER FRONT

*Underbed - x3*  
*LoLine - x3*  
*MidLine - x5*

#### DRAWER BACK

*Underbed - x3*  
*LoLine - x3*  
*MidLine - x5*

#### DRAWER BRACE

*Underbed - x3*  
*LoLine - x3*  
*MidLine - x5*

#### DRAWER BASE

*Underbed - x3*  
*LoLine - x3*  
*MidLine - x5*

Note: Drawer Boxes and Drawer Fronts packed in separate cartons

### Parts List - 45cm Drawers

Note: All of our Drawers assemble using the same steps, different parts.



**PINS**  
45cm - x24

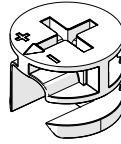

**CAMS**  
45cm - x24



**MEASURING TUBE**  
45cm - x1

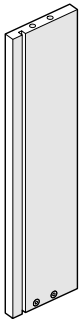

**SMALL DRAWER LEFT WALL**  
45cm - x2

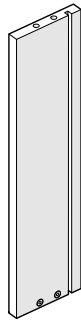

**SMALL DRAWER RIGHT WALL**  
45cm - x2

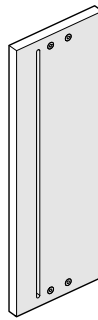

**SMALL DRAWER FRONT**  
45cm - x2

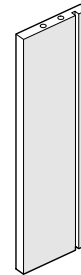

**SMALL DRAWER BACK**  
45cm - x2

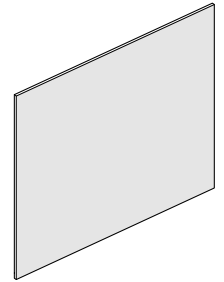

**DRAW BASE**  
45cm - x3

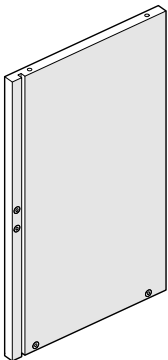

**LARGE DRAWER LEFT WALL**  
45cm - x1

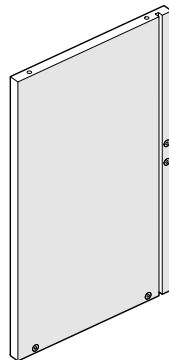

**LARGE DRAWER RIGHT WALL**  
45cm - x1

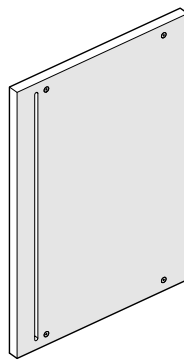

**LARGE DRAWER FRONT**  
45cm - x1

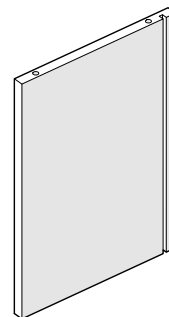

**LARGE DRAWER BACK**  
45cm - x1

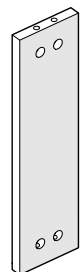

**LARGE DRAW BRACE**  
45cm - x1

Note: Drawer Boxes and Drawer Fronts packed in separate cartons

- 1** Screw Pins into nylon inserts in each Drawer Panel. Tighten until top of Pin is flush with 32mm Measuring Tube. Do not overtighten.

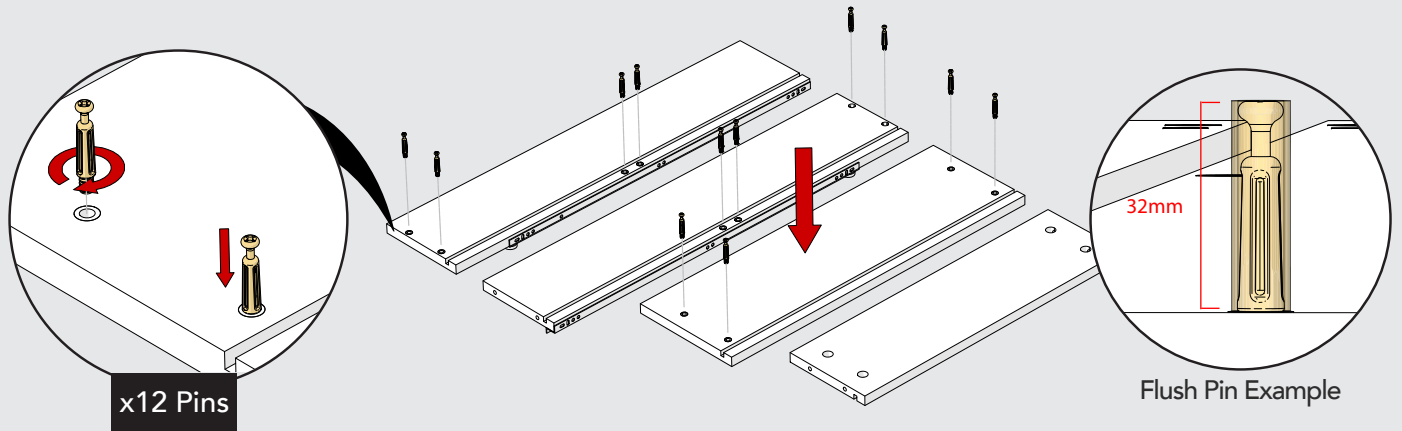

- 2**
- Place the Left Wall onto the ground, Pin side up. Align and lower the Back Wall and Brace onto the Pins.
  - Insert Cams into the holes and tighten.

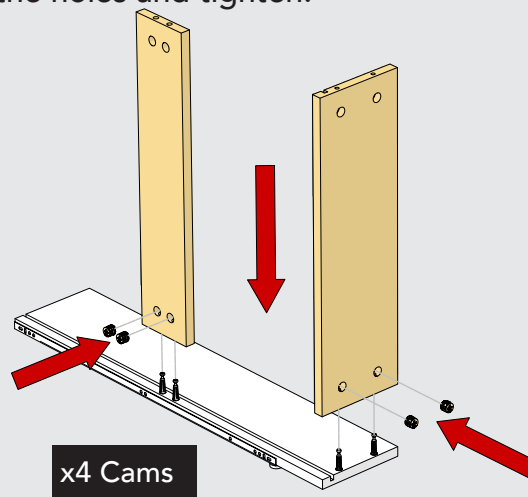

- 3** Slide Drawer Base into the channel in the Left & Back Wall.

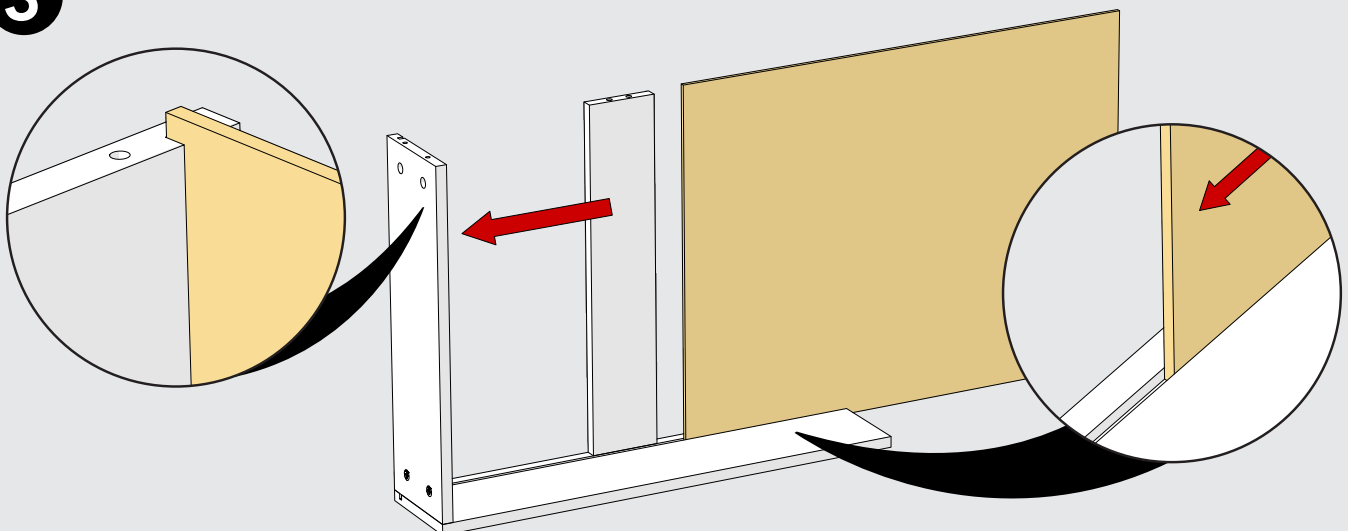

4

- Align Right Walls Pins and channel above Left Wall and Brace then lower.
- Insert Cams and tighten.

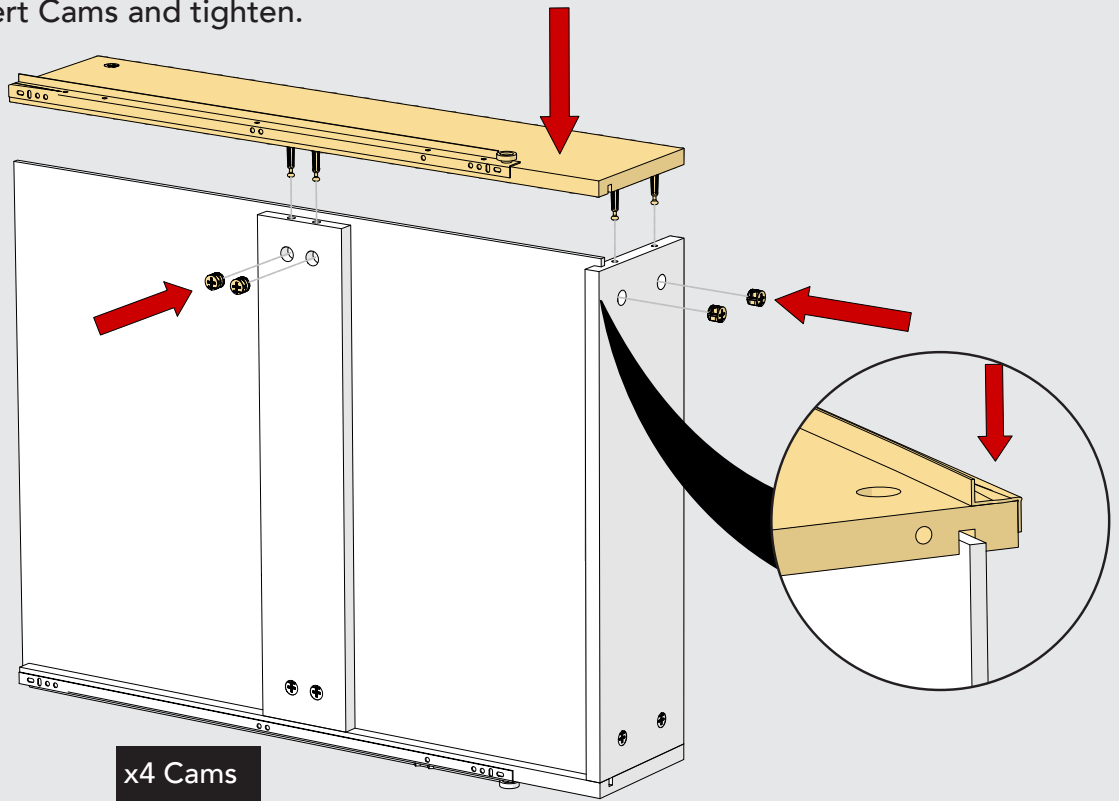

5

- Stand the draw upright. Align Pins on the Drawer Front and lower.
- Insert Cams and tighten.
- Repeat steps 1-5 (as many times as required for the drawer unit.)

