

# XRocker®

## MESH-TEK BY XRocker

# 5 CUBE UNIT TALL BLACK/RED

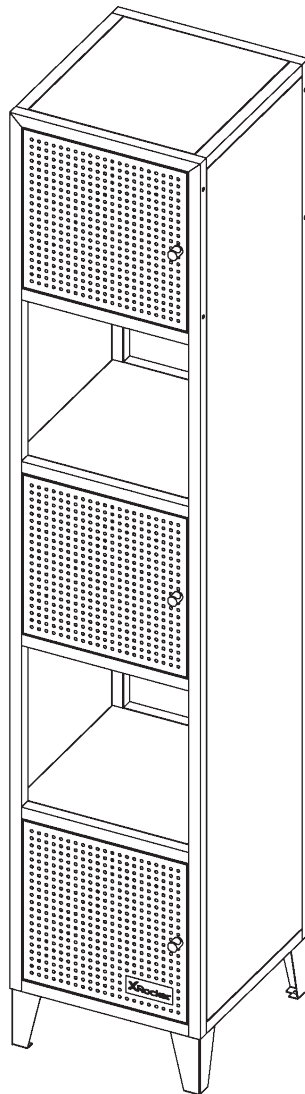

Need Help? Please visit the following webpage!

[www.xrockeruk.com/pages/support](http://www.xrockeruk.com/pages/support)

**IMPORTANT:** You must keep your original retail receipt as proof of purchase.



**ALL HOME FITTINGS ARE PERFORMED AT THE USERS OWN RISK.  
PLEASE CONSULT PROFESSIONAL ASSISTANCE IF NEEDED.**

**WARNING!** Serious or fatal crushing injuries can occur from furniture tip over. To prevent tip over this furniture must be used with the wall attachment device(s) provided. Screw(s) and plug(s) for the wall are not included. Do not climb or allow others to climb on the furniture once assembled. Use screw(s) and plug(s) suitable for your walls. If you are uncertain, seek professional advice. Read and follow each step of the instruction carefully. Please ensure components of the furniture are handled with care. Do not bend any parts. Improper handling may result in an unstable construction.

**ATTENTION!** Des blessures graves ou mortelles par écrasement peuvent survenir en cas de renversement de meubles. Pour éviter tout basculement, ce meuble doit être utilisé avec le(s) dispositif(s) de fixation murale fourni(s). Les vis et chevilles pour le mur ne sont pas incluses. Ne pas grimper ou permettre à d'autres de grimper sur les meubles une fois assemblés. Utilisez des vis et des chevilles adaptées à vos murs. Si vous n'êtes pas sûr, demandez conseil à un professionnel. Lisez et suivez attentivement chaque étape de l'instruction. Veuillez vous assurer que les composants du meuble sont manipulés avec soin. Ne pliez aucune pièce. Une mauvaise manipulation peut entraîner une construction instable.

**WARNUNG!** Durch das Umkippen von Möbeln können schwere oder tödliche Quetschverletzungen auftreten. Um ein Umkippen zu verhindern, müssen diese Möbel mit den mitgelieferten Wandbefestigungsvorrichtungen verwendet werden. Schraube(n) und Dübel(n) für die Wand sind nicht im Lieferumfang enthalten. Klettern Sie nicht auf die Möbel nach dem Zusammenbau und lassen Sie andere nicht darauf klettern. Verwenden Sie für Ihre Wände geeignete Schraube(n) und Dübel(n). Wenn Sie unsicher sind, suchen Sie professionellen Rat. Lesen und befolgen Sie jeden Schritt der Anleitung sorgfältig. Bitte achten Sie auf einen sorgsamem Umgang mit den Möbelteilen. Verbiegen Sie keine Teile. Unsachgemäße Handhabung kann zu einer instabilen Konstruktion führen.

**¡ADVERTENCIA!** Pueden producirse lesiones por aplastamiento graves o fatales si los muebles se vuelcan. Para evitar que se vuelque, este mueble debe utilizarse con los dispositivos de fijación a la pared proporcionados. Los tornillos y tacos para la pared no están incluidos. No se suba ni permita que otros se suban a los muebles una vez ensamblados. Utilice tornillos y tapones adecuados para sus paredes. Si no está seguro, busque asesoramiento profesional. Lea y siga cada paso de las instrucciones cuidadosamente. Asegúrese de que los componentes de los muebles se manipulen con cuidado. No doble ninguna pieza. Un manejo inadecuado puede resultar en una construcción inestable.

**WAARSCHUWING!** Ernstige of dodelijke verwondingen door beknelling kunnen ontstaan door het kantelen van meubels. Om kantelen te voorkomen, moet dit meubel worden gebruikt met de meegeleverde wandbevestiging(en). Schroeven en plug(gen) voor de muur zijn niet inbegrepen. Klim niet of laat anderen niet op het meubilair klimmen als het eenmaal is gemonteerd. Gebruik schroeven en plug(gen) die geschikt zijn voor uw muren. Als u niet zeker bent, zoek dan professioneel advies. Lees en volg elke stap van de instructie zorgvuldig. Zorg ervoor dat onderdelen van het meubel met zorg worden behandeld. Buig geen onderdelen. Onjuiste behandeling kan resulteren in een onstabiele constructie.

**AVVERTIMENTO!** Il ribaltamento del mobile può provocare lesioni da schiacciamento gravi o mortali. Per evitare il ribaltamento, questo mobile deve essere utilizzato con il/i dispositivo/i di fissaggio a parete in dotazione. Viti e tasselli per il muro non sono inclusi. Non salire o permettere ad altri di arrampicarsi sui mobili una volta montati. Usa viti e tasselli adatti alle tue pareti. Se non sei sicuro, chiedi una consulenza professionale. Leggere e seguire attentamente ogni passaggio delle istruzioni. Si prega di assicurarsi che i componenti dei mobili siano maneggiati con cura. Non piegare nessuna parte. Una manipolazione impropria può provocare una costruzione instabile.

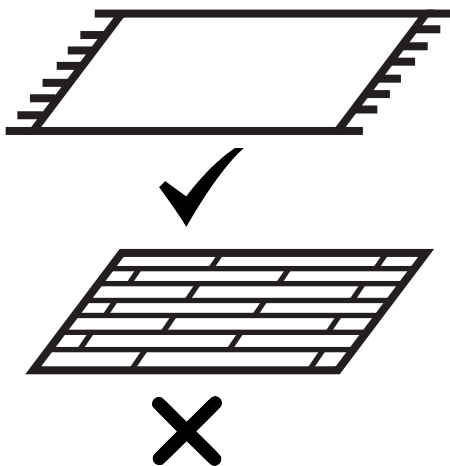

**PLACE FURNITURE ON SOFT SURFACE DURING ASSEMBLY**

**NEED HELP?**



**CONTACT**

[www.xrockeruk.com/pages/support](http://www.xrockeruk.com/pages/support)

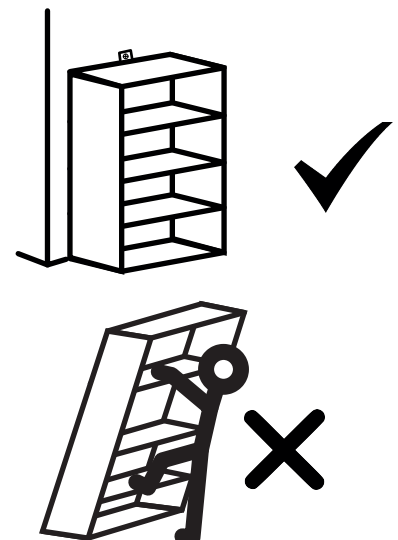

**DO NOT CLIMB ON FURNITURE**



1

X 1

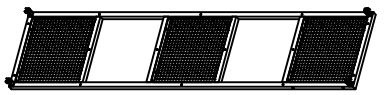

2

X 1

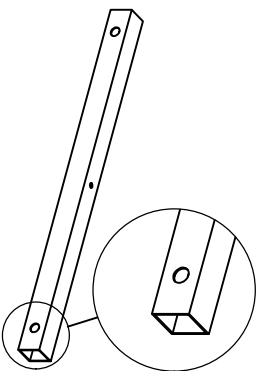

3

X 2

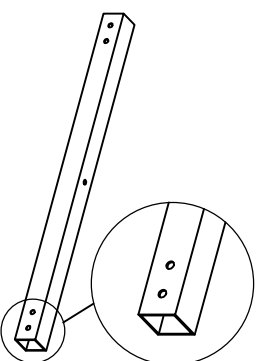

4

X 2



5

X 2

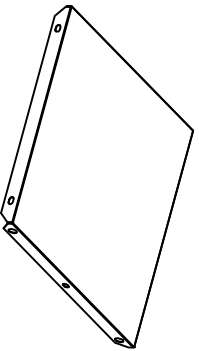

6

X 2

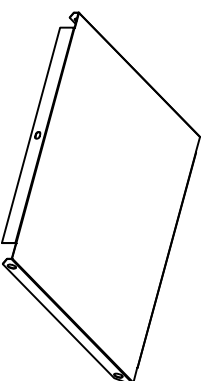

7

X 4

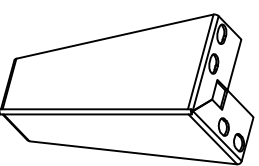

8

X 4

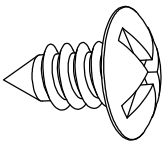

A

M5X12

X 48

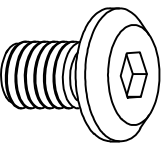

B

M6X10

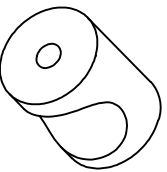

C

X 8

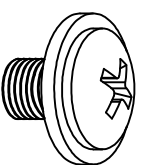

D

X 3 M4X4

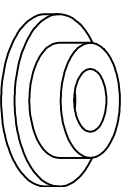

E

X 5

X 4

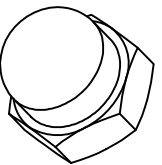

F

M4

X 2

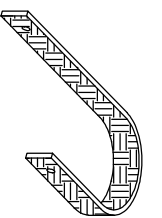

G

X 2

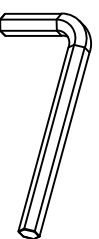

H

X 1

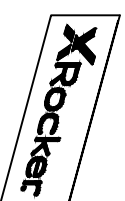

I

X 1

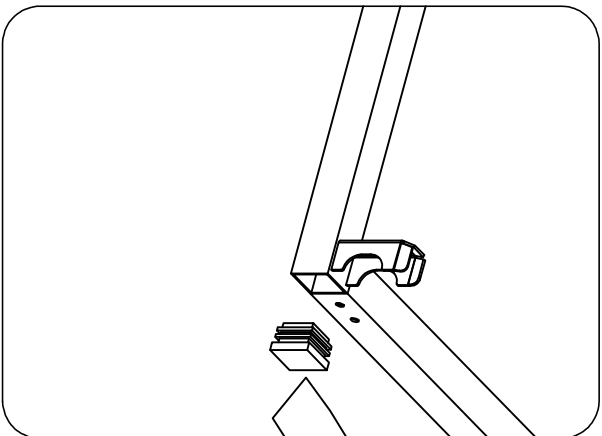
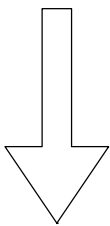
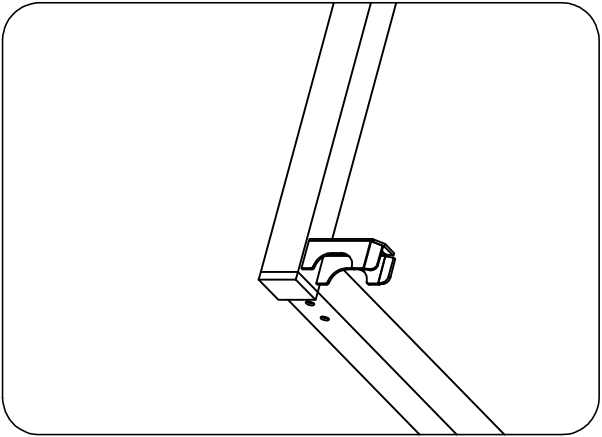

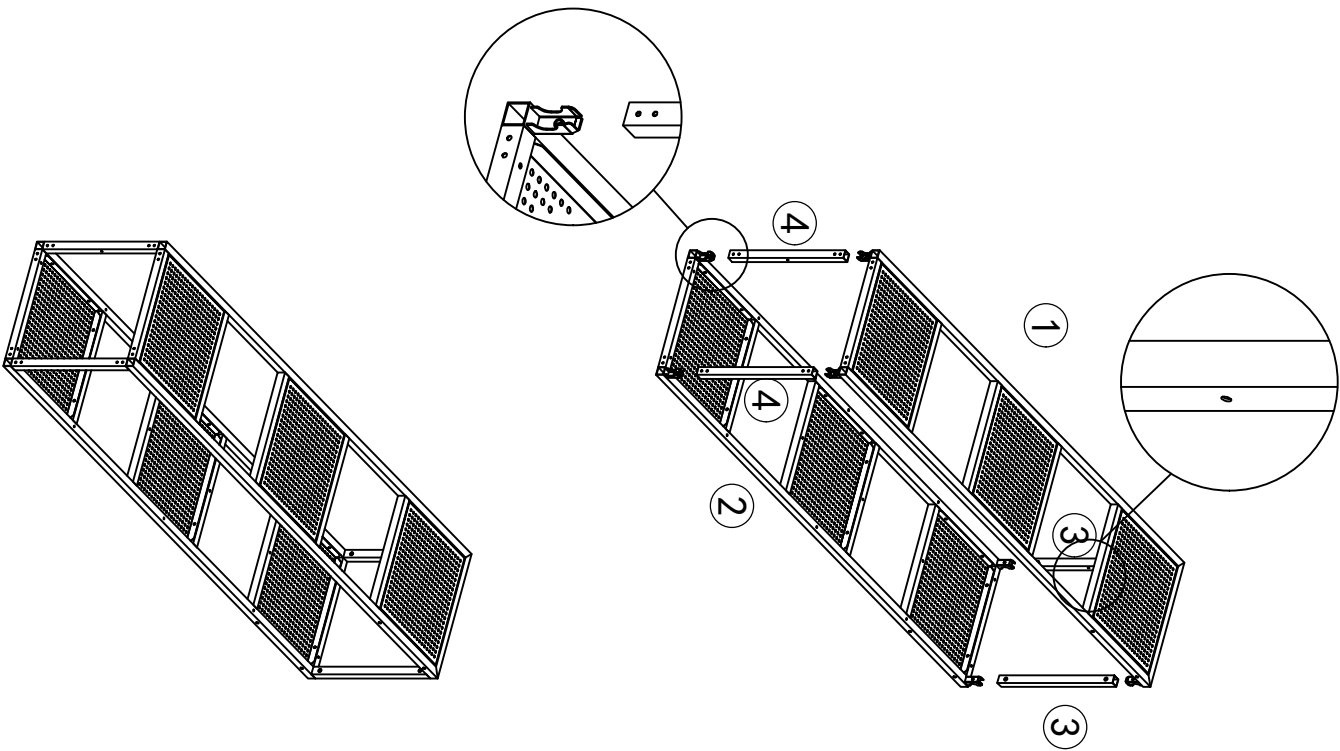

**Retain plastic caps for  
future use or product  
transportation**

1

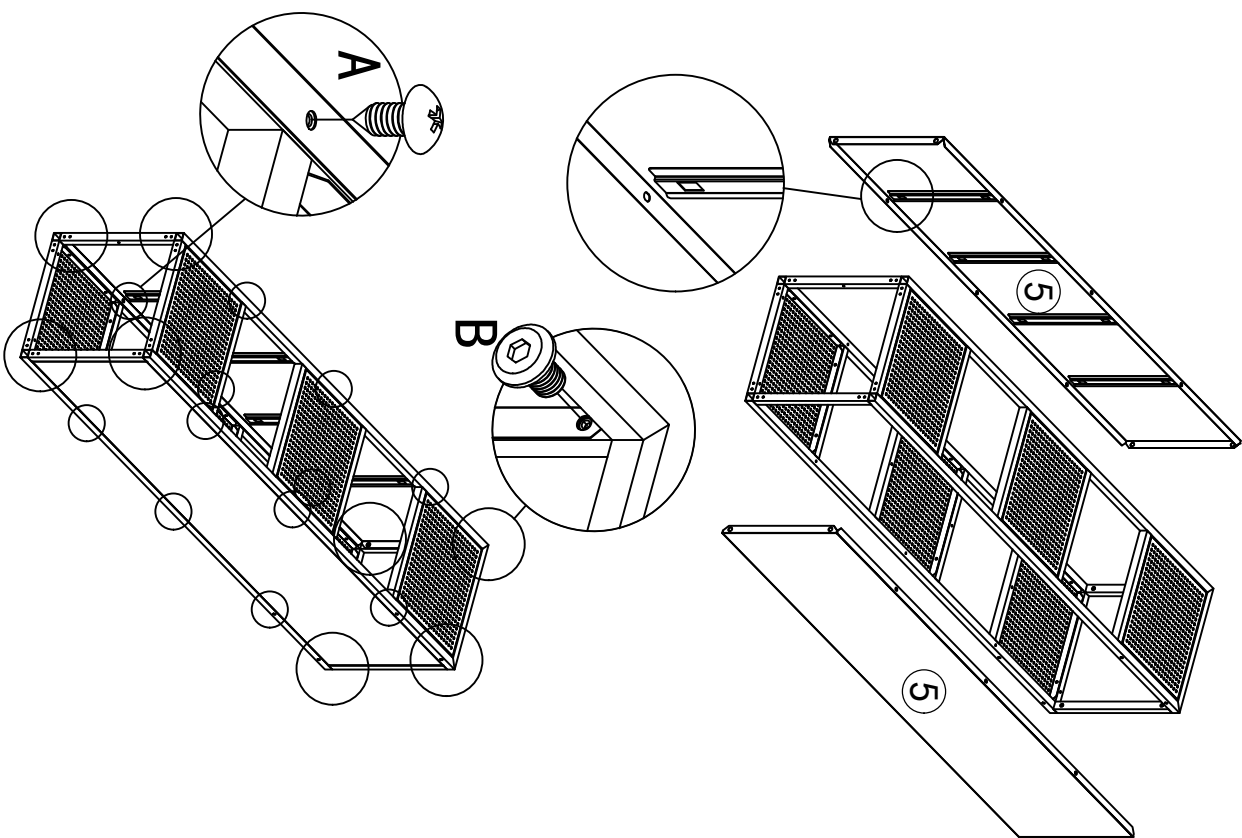

2



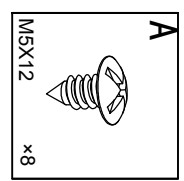
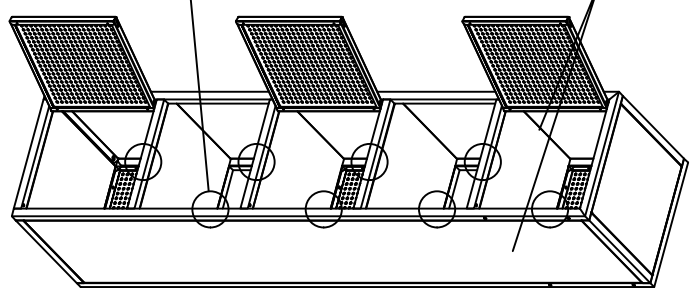
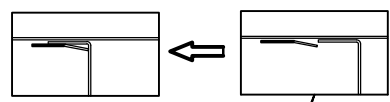
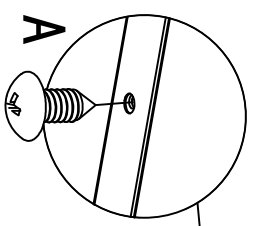
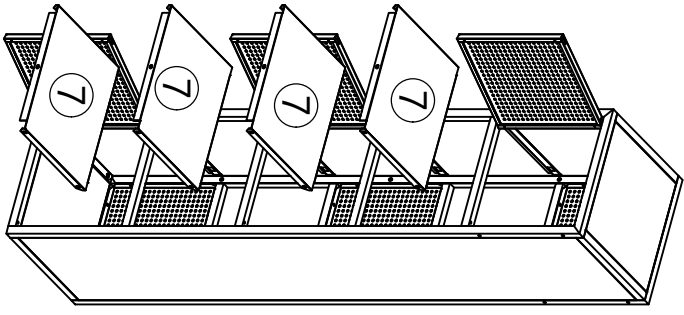
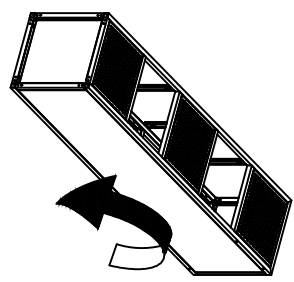
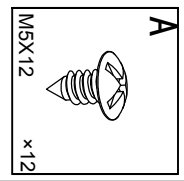
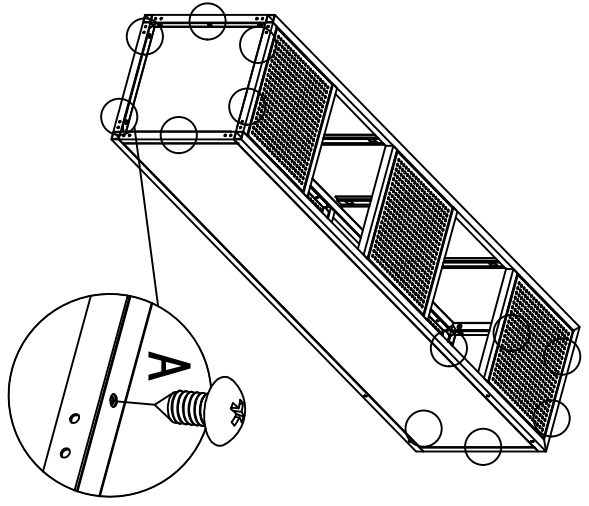
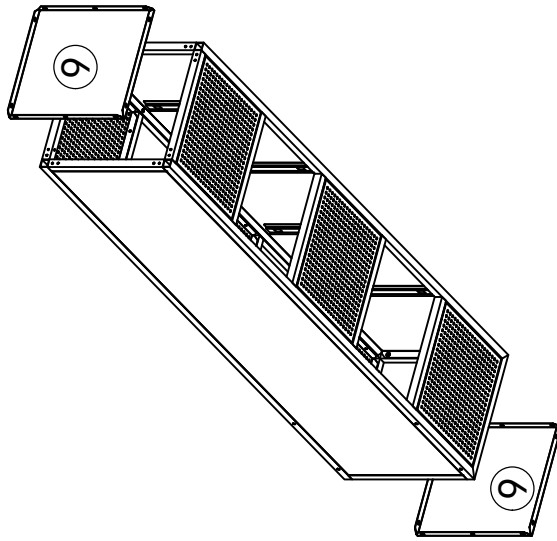

<p><b>A</b></p>  <p>MSX12</p>	<p><b>B</b></p>  <p>x12   M6X10 x8</p>
--	---



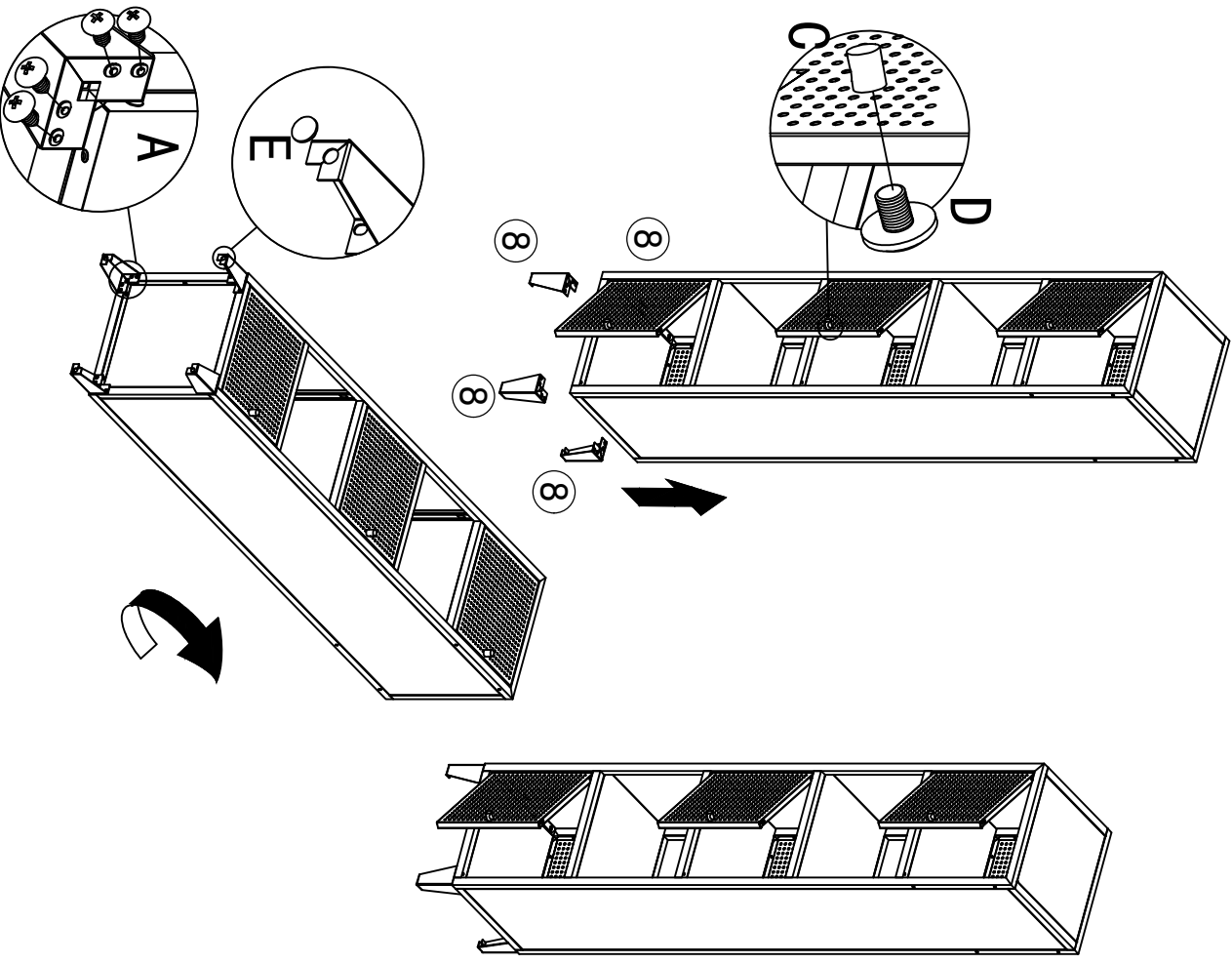

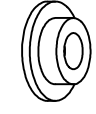
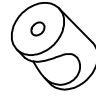

5

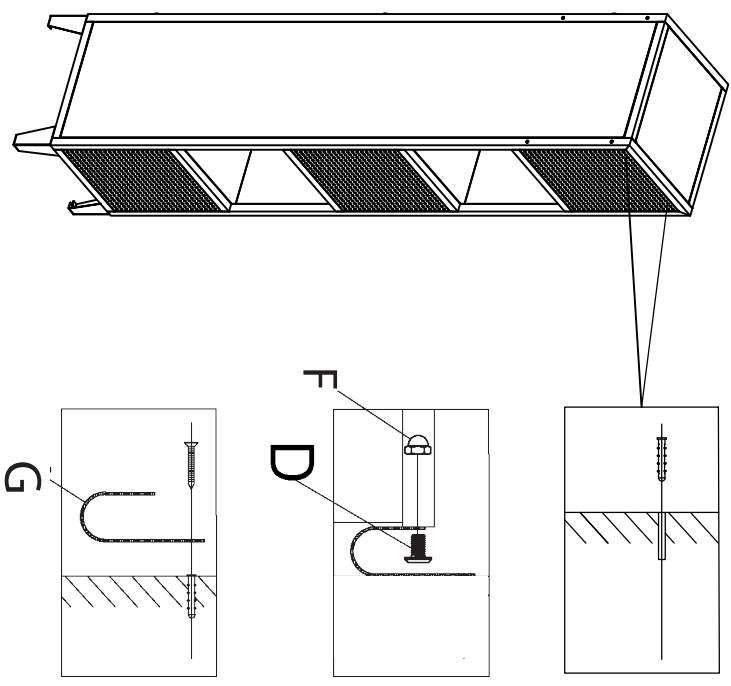

<p><b>A</b></p>  <p>M5X12 x16</p>	<p><b>D</b></p>  <p>M4X4 x3</p>	<p><b>E</b></p>  <p>x4</p>	<p><b>C</b></p>  <p>x3</p>
--	--	---	--

6



<p><b>D</b></p>  <p>M4X4 x2</p>	<p><b>F</b></p>  <p>x2</p>	<p><b>G</b></p>  <p>x2</p>
--	---	---

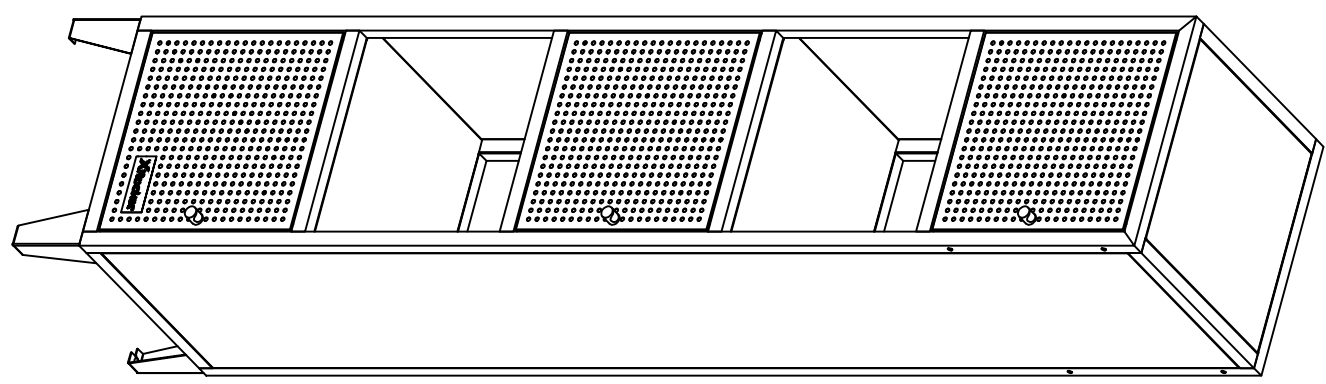
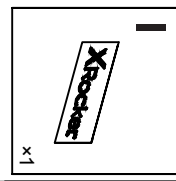
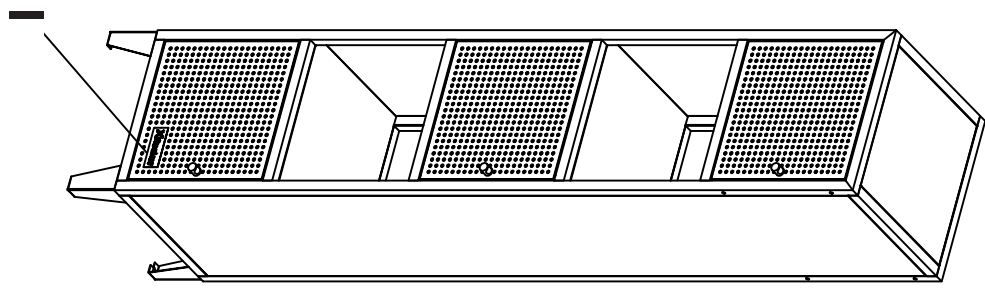



# A Guide to Wall Mounting & Fixings

If plastic wall plugs are supplied



These are only suitable for use in masonry walls

If you are in any doubt about the correct wall plugs for your wall, seek professional assistance.



**Important: When drilling into walls always check that there are no hidden wires or pipes.**

Make sure that the screws and wall plugs being used are suitable for supporting your unit.

Consult a professional assistance if you are unsure.

**ALL HOME FITTINGS ARE PERFORMED AT THE USERS OWN RISK. PLEASE CONSULT PROFESSIONAL ASSISTANCE IF NEEDED.**

## TYPES OF WALLS

**No.1 "General Purpose" wall plug**

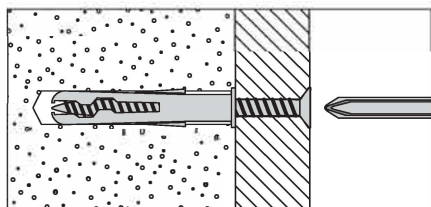

Generally aerated blocks should not be used to support heavy loads, use a specialist fitting in this case. For light loads, general purpose wall plugs can be used.

**No.2 "Plasterboard" wall plug**

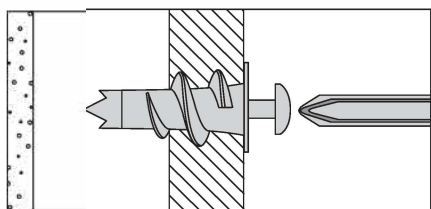

For use when attaching light loads on to plasterboard partitions.

**No.3 "Cavity Fixing" wall plug**

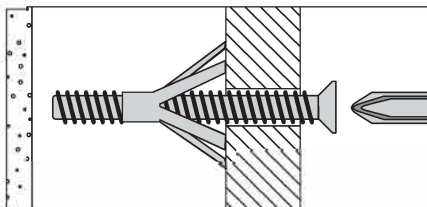

For use with plasterboard partitions or hollow wooden doors.

**No.4 "Cavity Fixing-Heavy Duty" wall plug**

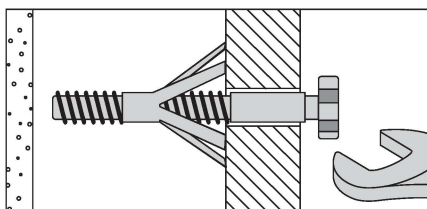

For use when fitting or supporting heavy loads such as shelving, wall cabinets and coat racks.

**No.5 "Hammer Fixing" wall plug**

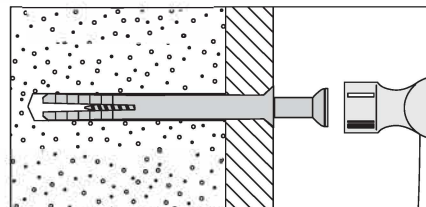

For use with walls stuck with plasterboard. The hammer fixing allows it to be fixed to the wall rather than the plasterboard. Always check the fixing is secure to the retaining wall.

**No.6 "Shield Anchor" wall plug Heavy loads**

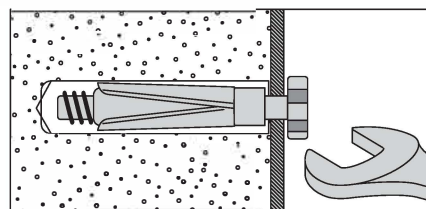

For use with heavier loads such as TV & HiFi speakers and satellite dishes etc.



### Care & Maintenance

Please check the location of the furniture to ensure safety before fitting to the wall.

Please check fittings periodically to ensure that they remain securely fastened to the wall.