

SWISS  
KUBIK



WHAT YOU VALUE  
DESERVES TO BE  
CARED FOR



## YOUR TIMEPIECES DESERVE TO BE LOOKED AFTER

### **It is the thought that counts...**

It is acknowledged that even complicated automatic mechanical watches operate on a simple principle: the movements of the person who is wearing the watch allow the oscillating weight to rotate and, in doing so, to rewind the movement. As long as the watch is being worn, the movement rewinds automatically. If the watch is not worn, the power reserve - 40 hours in most cases - runs out and the movement stops. If the stoppage time is prolonged, the lubricants can dry out, which in turn can cause the gear train to seize so altering the good functioning of the watch.

### **Complication: attentions...**

The mechanism of the perpetual calendar, for example, has a mechanical memory that allows it to automatically go from 28th, 30th or 31st of the month to the 1st of the following month. The same applies to leap years, that is to say every four years; the date passes from 29 February to 1 March by "jumping". The only manual adjustment required must be made during the years 2100 and 2400, which exceptionally are non-leap years. If the movement stops, restarting the mechanism requires an in-depth knowledge of watchmaking. That is why a complicated watch must always be in motion.

### **Maintenance and transmission**

The precise and regular maintenance of your timepiece makes it possible to protect the investment it represents in a possible transmission perspective.

## PROTECT. MAINTAIN. ENHANCE.

In order to preserve the value you attach to your timepiece, it is advisable to conjugate three verbs in the present tense.

### **Protect**

When a timepiece is not worn, the easiest way to protect it from shocks, scratches, water, dust, etc. is its case or its watch winder. Regular cleaning is also a good protection against daily aggression or the passage of time.

### **Maintain**

If the watch is not worn regularly, it is advisable to place the timepiece in a watch winder. In addition, a regular inspection of the seal by an authorised watchmaker guarantees it functions properly and maintains its value.

### **Enhance**

Sophisticated system of great precision, an automatic watch is also a beautiful piece of work that we like to wear and admire. Apart from your wrist, what better place to highlight it than a watch winder?



### The watch winder: it turns heads

At home or on the move, placing your automatic watch in a watch winder makes it possible to protect it, to maintain it by keeping it always on time and to enhance it. This is all the more justified if the owner owns several watches or watches with complications. Some programmable watch winders allow to set the winding time and the number of revolutions, the speed and the direction of rotation for an optimal setting according to the timepiece.

Thanks to invented, proven and recognised technologies, SwissKubiK offers a wide range of watch winders designed, developed and assembled in Switzerland.

### Swiss Made: the incontestable quality

All SwissKubiK watch winders meet the requirements of the Swiss Made label. Since the creation of the company in 2007, our products have been designed and assembled by hand in Switzerland, in our manufacture of Givisiez, three kilometres from Fribourg, in the canton of the same name.

Engraved on the back of each case, this simple mention is the guarantee of an immutable requirement and a flawless quality. It also reflects this clever marriage of respect for tradition and the great capacity for innovation that Switzerland can show.

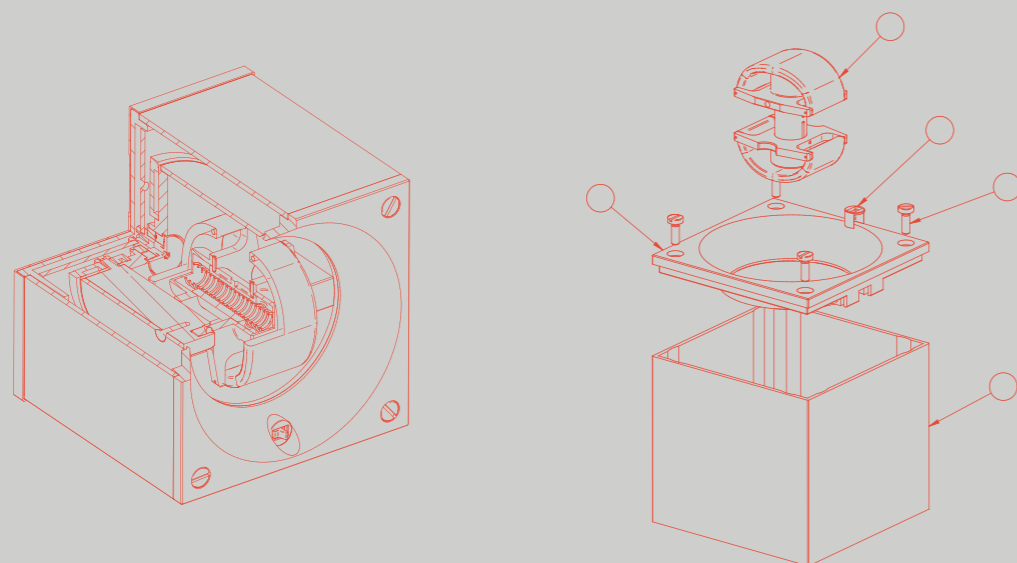

### Watch winders for connoisseurs

Our watch winders meet the highest standards, so as to better meet those of a clientele of connoisseurs.

Therefore, each watch winder features:

- a motor without magnetism,
- an ultra-silent system,
- a programming system (on Masterbox and Travelbox models) making it possible to define the number of revolutions, the speed and the direction of rotation according to the models,
- the counting of the revolutions,
- the repositioning of the watch at 12 o'clock after each rotation session so that the watch is always in the "case" position,
- an exceptional autonomy of approximately three years on batteries, thanks to low-energy motor and electronic circuit (1.2 mA).

In addition, our watch winders are particularly appreciated for:

- their irreproachable quality, thanks to an assembly being entirely carried out by hand by our teams and a quality control carried out on each piece,
- their unique mounting system allowing to replace in one gesture the external structure, to change style at will, but also to modify the mechanical parts,
- their reduced and optimised size - 12 x 12 cm for a Startbox or 10 x 10 cm for a Masterbox - for convenient storage in a safe,
- their timeless design that comes in multiple variations of materials and colours.

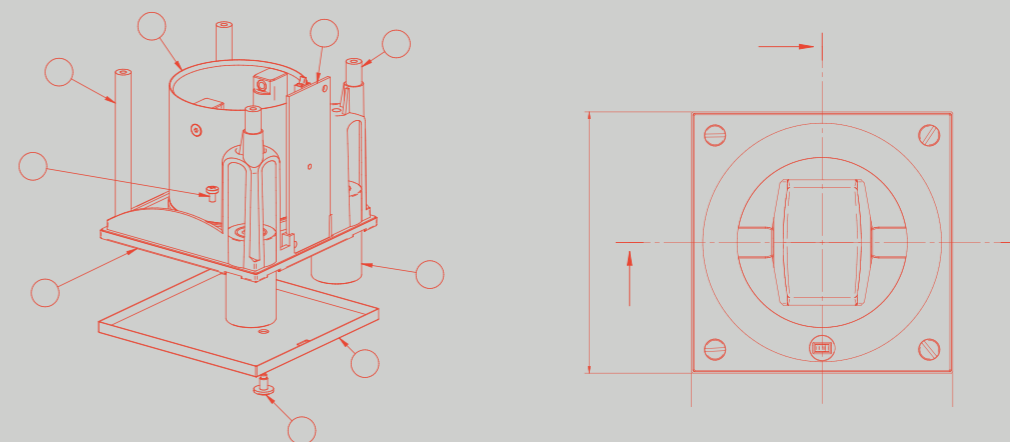



#### **Your timepiece merits a made-to-measure watch winder**

To meet all the requirements, the SwissKubiK watch winders are available in a wide range of materials - leather, with or without stitching, aluminium, wood, carbon, etc. -, colours and combinations of watch winders.

The customisation includes the printing of patterns, logos or photos on any type of material, whether UV, hot stamping or laser engraving, and this on the entire range.

#### **R&D: the origin of excellence**

Since its creation, SwissKubiK has continuously improved its system. Today, we present our sixth generation of rotation system, which includes both the mechanical and the electronic parts, that is to say the motor and the programming circuit.

Innovation is essential to create unique products that meet the needs of a demanding private clientele. In the same way, we collaborate with more than twenty watchmaking companies for which we integrate our motors in their watch winders.

#### **Strong ecological awareness**

In compliance with the Swiss Made quality label and in order to limit its carbon footprint, all SwissKubiK suppliers have been selected within a radius of 50 kilometres around its manufacture of Givisiez (FR) factory.

#### **A simple idea**

2007. SwissKubiK was created in Geneva, Switzerland, with a desire to innovate in the field of automatic watch winding by proposing small and autonomous watch winders.

#### **Traditional craftsmanship**

The first watch winders were entirely made by hand in the purest Swiss tradition and were manufactured in the same year (2007).

#### **Cutting-edge technology**

The SwissKubiK watch winders are equipped with an ultra-silent, non-magnetic, energy-saving motor - three years of autonomy - and programmable for the Masterbox and Travelbox range.

#### **100% Swiss Made**

Designed, developed and assembled in Switzerland, they meet the requirements of the Swiss Made label, synonymous with durability, reliability, quality and precision, to sum up "excellence".

#### **Made-to-measure watch winders**

Leather, wood, aluminium, stitching, engravings, made-to-measure: the SwissKubiK watch winders are available in a great variety of materials, colours and finishings for a unique experience. They are available in single or multiple versions – for up to 12 watches - with individual programming. Ideal for collectors.





**A brand of confidence**

SwissKubiK creations meet all the requirements of Swiss watchmaking. This is why the company is recommended by more than twenty Swiss watch companies which it collaborates regularly with.

**Intelligent collaboration**

In 2017, SwissKubiK joined forces with Scatola del Tempo, the Italian pioneer of watch winders, to expand its product range, create synergies and meet the demands of a growing market. Together, they now offer the best of design and technology.





SK01.STB001  
Black

SK01.STB002  
Green

# STARTBOX

The Starbox comes in 6 bright colors : red, blue, orange, green, grey or black. Its exterior cover has a Softtouch finish, pleasant to the touch, integrating a SwissKubiK mechanism for beautiful-watches lovers. This model functions solely on batteries and offers, as always, a minimum autonomy of 3-years.

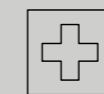

Made in Switzerland

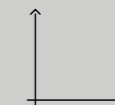

Dimensions :  
12 × 12 × 12 cm

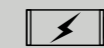

Powered by 2 standard  
«C-type» alkaline batteries  
with a lifespan of 3-years  
in steady operation



Material: ABS plastic



3-years international  
warranty



Stops in a vertical position



Exclusive, modern and  
contemporary design



1 standard program with  
1800 rotations per day

# STARTBOX



**SK01.STB005**  
Blue



**SK01.STB004.SWISS**  
Red/Swiss cross

# STARTBOX



SK01.STB001  
Black



SK01.STB002  
Green



SK01.STB004  
Red



SK01.STB010  
Orange



SK01.CV005  
Green Toledo

# MASTERBOX

## **Masterbox wood**

Alliance of design and precious wood, such as Macassar, Sycomore or Wenge, to reflect the quality and excellence of the SwissKubiK mechanism.

## **Masterbox aluminium**

Flagship product of the Masterbox range since the beginning, the aluminium finish offers new shades for its 10 years anniversary: a 13-colours palette to create a perfect harmony between the watch and its case.

## **Masterbox leather**

Elegant and masculine, our Masterbox collection has everything going for it: its Toledo leather casing, renowned for its exceptional quality, is available in several timeless shades. A Kubik with a unique natural touch, whose casing acquires a unique patina over time to reveal all its beauty. A true collectible item, to choose with white topstitch or tone on tone.

# MASTERBOX



Made in Switzerland



Dimensions:  
10 × 10 × 10 cm



Materials:  
Aluminium, Leather, Wood



Stops in a vertical position



Works on power supply and can be powered by 2 standard «C-type» alkaline batteries with a lifespan of 3-years in steady operation



3-years international warranty



Exclusive, modern and contemporary design



USB and/or Bluetooth connection offers a customisation of the program



Fully programmable



Window protection available as an option



Entirely customisable



Wood



Leather



Aluminium

# MASTERBOX

Wood



**SK01.BFG001**  
Shiny varnished gray



**SK01.BZ001**  
Zebra ash



SK01.BW001  
Natural Wenge



SK01.BYV001  
Yacht veneer

# MASTERBOX

Leather



SK01.CV003  
Black/Black stitches

SPECIAL

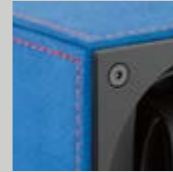

SK01.CA.BLEU CLAIR C/Rouge  
PASSION BLUE/RED STITCHES

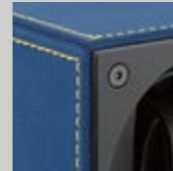

SK01.CA.BLEU Nuit C/Jaune  
WINDSOR BLUE/YELLOW STITCHES

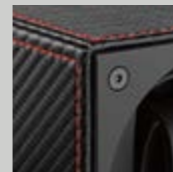

SK01.CV.CARBONE C/Rouge  
BLACK CARBON/RED STITCHES

RACING

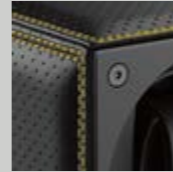

SK01.CV.RC.JAUNE  
BLACK/DOUBLE YELLOW STITCHES



SK01.CV.RC.VERT  
BLACK/DOUBLE GREEN STITCHES



SK01.CV.RC.BLEU  
BLACK/DOUBLE BLUE STITCHES

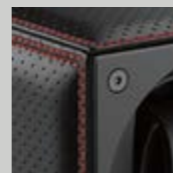

SK01.CV.RC.ROUGE  
BLACK/DOUBLE RED STITCHES

COUTURE



SK01.CV.COUTURE.BLANC MAT C/GRIS  
WHITE/GREY STITCHES

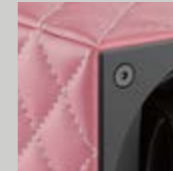

SK01.CV.COUTURE.ROSE C/BLANCHE  
PINK/WHITE STITCHES

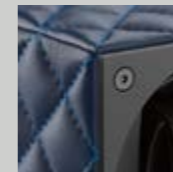

SK01.CV.COUTURE.BLEU NUIT C/BLEU  
DARK BLUE/BLUE STITCHES



SK01.CV.COUTURE.NOIR C/BLANCHE  
BLACK/WHITE STITCHES



SK01.CV.COUTURE.NOIR T/T  
BLACK/BLACK STITCHES

GT

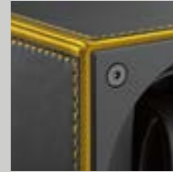

SK01.CV.GT.JAUNE  
BLACK/YELLOW EDGE & STITCHES



SK01.CV.GT.VERT  
BLACK/GREEN EDGE & STITCHES



SK01.CV.GT.VERT FONCE  
BLACK/DARK GREEN EDGE & STITCHES



SK01.CV.RC.BLEU  
BLACK/BLUE EDGE & STITCHES

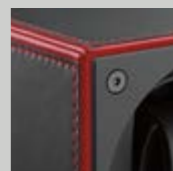

SK01.CV.GT.ROUGE  
BLACK/RED EDGE & STITCHES

CLASSIC



SK01.CV004  
BROWN/BROWN STITCHES



SK01.CV006  
DARK BLUE/BLUE STITCHES



SK01.CV001  
BLACK/WHITE STITCHES



SK01.CV002  
HONEY/ WHITE STITCHES



SK01.CV005  
GREEN/WHITE STITCHES





SK01.CV.COUTURE.NOIR T/T  
Black/Black stitches

#### Masterbox couture

A new "couture" collection inspired by the latest fashion trends: a variation of leathers stitched to showcase our watch winders. A noble cover available in several unique colours (Pink, White, Blue or Black), offering an unmatched elegance.

### Masterbox racing

Inspired directly from the world of car racing, the Masterbox, jewel of the SwissKubiK range, is covered in black Toledo leather, stitched in red, blue, green or yellow.

SK01.CV.RC.JAUNE  
Black/Double Yellow stitches

SK01.CV.CARBONE C/Rouge  
Black carbon/Red stitches



# MASTERBOX

Aluminium



SK01.AE001  
Black



SK01.AE000  
Brushed



SK01.AE002  
Silver



SK01.AE015  
Taupe

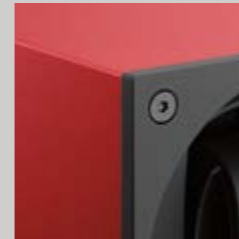

SK01.AE005  
Red

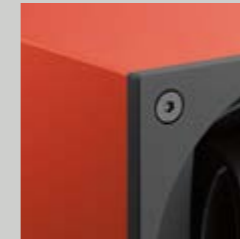

SK01.AE010  
Orange



SK01.AE009  
Pink

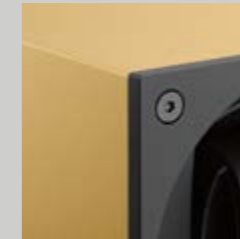

SK01.AE006  
Yellow Gold

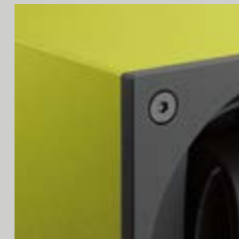

SK01.AE011  
Citrus

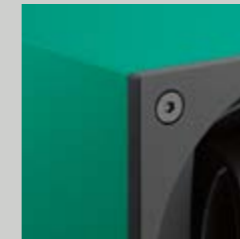

SK01.AE007  
Green

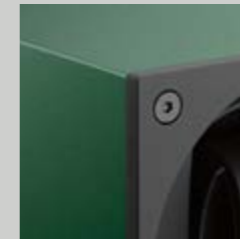

SK01.AE014  
Dark Green



SK01.AE008  
Sapphire blue



SK01.AE004  
Dark blue



SK01.AE001  
Black anodised aluminium

## INNOVATION FOR TRADITION...

Once again, 2019 is marked by innovation for SwissKubiK. The company launches its first watch winders equipped with the latest Bluetooth technology.

By means of a dedicated application that automatically recognises the SwissKubiK watch winders, the owner is able to:

- program his or her watch winder (s) remotely,
- adjust the light,
- check the condition of the batteries,
- individually program each watch winder in case of multiple watch winders,
- give a name to each winder according to the watch,
- save and preserve the batteries which will only work when the watch winder is activated by the application.



Bluetooth connection with phones offers a customization of the program



QR code to download the Bluetooth application.



Kubric



SK03.CV004  
Brown toledo leather

# MULTIPLE

Our Masterboxes are also available as multiples: you can thus create your own casings combinations according to your needs (up to 12 units) with different materials and styles.

# MULTIPLE



SK02.AE002  
Silver anodised aluminium



SK03.BW001  
Natural Wenge wood



SK06.CV001  
Black Toledo leather

A hand in a dark leather glove holds a black watch box. A silver metal piece, possibly a watch case back or a decorative element, is being held over the box. The metal piece is engraved with the word 'Kubik' and 'SWISS MADE'. The background is a blurred, dark blue-grey color.

# OPTIONS

## **Personalisation**

For our made-to-order experience, SwissKubiK offers to its customers the possibility to personalize their own watch-winder. We are able to offer such service by combining our Swiss Made legendary quality and the latest UV printing or laser technology. Once you have found the perfect model, you just have to choose the finish you love, the color that will make a difference, the technology to personalize your watch-winder and so on...

## **Window protection**

As an option for each of the KubiK models, the window protection enables an optimal conservation for each watch.





# TRAVELBOX

For those who like to take their watches on the road while preserving them, we've created Travelbox!

**Travelbox is both a storage case and a rotating case.**

Travelbox follows you on all your trips. Your watch is protected during transport in its dedicated spot and doesn't move. Once arrived at your destination, you just have to take out your watch and its cushion to place them on the winding part and activate your Travelbox. Thereby, the watch you don't wear is always on time and maintained wherever you are in the world, regardless of your travel conditions. And of course, Travelbox offers SwissKubiK quality with a 100% Swiss Made box.

Travelbox is available in different materials and colours.

# TRAVELBOX



Made in Switzerland



Dimensions:  
20 x 7 x 11,5 cm



Materials:  
Leather, Recycled Material



Stops in a vertical position



Works on power supply and/  
or rechargeable battery



3-years international warranty



Exclusive, modern and  
contemporary design



USB and/or Bluetooth connection  
offers a customisation of the  
program



Fully programmable



## TECHNICAL DESCRIPTION

MODEL	MATERIAL	DIMENSIONS	PROGRAM	POWER SUPPLY	BATTERY LIFE	WARRANTY
STARTBOX	ABS plastic	12 x 12 x 12 cm	1 STANDARD PROGRAM	Battery (2xLR14 - 1.5V)	3 YEARS	3 YEARS
MASTERBOX SINGLE	Aluminium, leather, wood	10 x 10 x 10 cm	FULLY PROGRAMABLE	Power supply and/or batteries (2xLR14 - 1.5V)	3 YEARS	3 YEARS
MASTERBOX DUO	Aluminium, leather, wood	20 x 10 x 10 cm	FULLY PROGRAMABLE	Power supply and/or batteries (2xLR14 - 1.5V)	3 YEARS	3 YEARS
MASTERBOX TRIO	Aluminium, leather, wood	30 x 10 x 10 cm	FULLY PROGRAMABLE	Power supply and/or batteries (2xLR14 - 1.5V)	3 YEARS	3 YEARS
MASTERBOX QUATTRO	Aluminium, leather, wood	20 x 20 x 10 cm	FULLY PROGRAMABLE	Power supply and/or batteries (2xLR14 - 1.5V)	3 YEARS	3 YEARS
MASTERBOX 6	Aluminium, leather, wood	30 x 20 x 10 cm	FULLY PROGRAMABLE	Power supply and/or batteries (2xLR14 - 1.5V)	3 YEARS	3 YEARS
MASTERBOX 8	Aluminium, leather, wood	40 x 20 x 10 cm	FULLY PROGRAMABLE	Power supply and/or batteries (2xLR14 - 1.5V)	3 YEARS	3 YEARS
MASTERBOX 12	Aluminium, leather, wood	40 x 30 x 10 cm	FULLY PROGRAMABLE	Power supply and/or batteries (2xLR14 - 1.5V)	3 YEARS	3 YEARS
TRAVELBOX	Leather, Recycled Material	20 x 7 x 11,5 cm	FULLY PROGRAMABLE	Power supply and/or rechargeable batteries	-	3 YEARS

Thanks to:

Dietrich Watches - [www.dietrich.com](http://www.dietrich.com)



DIETRICH

Teo Jakob – [www.teojakob.ch](http://www.teojakob.ch)

**teo jakob**

Einrichtung &  
Innenarchitektur

Photo credit: Nicolas Schopfer



printed in  
**switzerland**

The products and accessories as well as the trademarks and the trades names presented in this catalogue are protected and remain the exclusive property of SwissKubiK SA. Any attempts to counterfeit them will be prosecuted.

The models which appears in this catalogue are not all reproduced to exact size. In the same way, the colours may differ slightly from the original due to the effects of the reproduction.

