

FreeWheel™

Wheelchair Attachment



Set-Up Guide and Registration

- Pages 1-4: Steps to Set-Up your FreeWheel
- Page 5: Pinning Clamp Plate Footrests and TiLite™ Angle-Adjustable Footrest Requirements
- Page 6: Storage “Perch” Set-Up Guide
- Page 7: How to Adjust the Steering Mechanism
- Page 8: How to Maintain your FreeWheel
- Page 9: How to Remove Wheel for Tire/Tube Change
- Back: FreeWheel Warranty and Registration

A video of this Set-Up Guide is available at www.gofreewheel.com.



FreeWheel Wheelchair Attachment



On Instagram: GO_FREEWHEEL



On Twitter: GoFreeWheel

How To Set-Up Your FreeWheel

This Set-Up Guide provides step-by-step directions for setting up your FreeWheel to fit your wheelchair. (Note: start on page 5 if you have a clamp plate footrest or a TiLite Angle Adjustable footrest.)

1. Determine whether you need a cup shim? (page 1)
2. Does it need a straight shim and if yes, what thickness? (page 2)
3. Adjusting the angle based on how high your footrest is from the floor and whether it is angled. This adjustment is to make sure the FreeWheel properly lifts the front casters off the ground. (page 3)
4. Should you use a short or long rear end? (page 4)

Once your FreeWheel is set up, it is important to MAINTAIN it so it provides you with years of enjoyment. (page 8)

STEP 1: Cup Shim

(FreeWheel comes with cup shim installed.)

Check which footrest type you have and decide whether or not it needs a cup shim.

FOOTREST TYPES

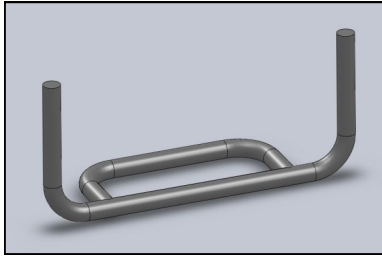

2 TUBE

2 Tube: YES, you need a cup shim.
Make no change and go to STEP 2 (page 2).

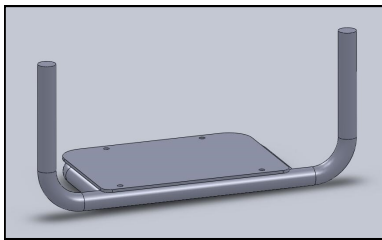
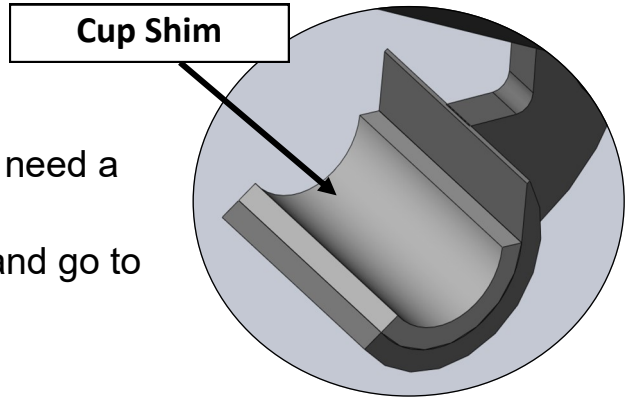

2 TUBE with PLATE

2 Tube with Plate: YES, you need a cup shim.
Make no changes and go to STEP 2 (page 2).

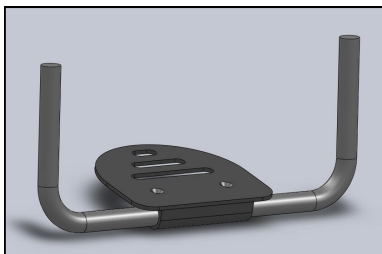

CLAMP PLATE

Clamp Plate: NO, you do not need a cup shim.
REMOVE CUP SHIM using small phillips-head screw driver to remove screws and GENTLY pry plastic cup shim out. Go to STEP 2 (page 2).



STEP 2: Which Straight Shim?

Your footrest type determines if you need a straight shim and if you do, which straight shim to use. Do NOT install the rear end during this step. Footrest depths less than 4", that require a straight shim, will need the shim cut to the depth of the footrest.

Footrest Types

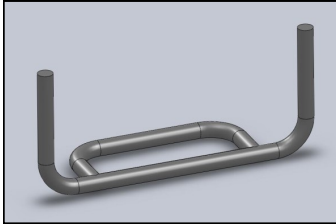

2 TUBE

2 Tube: Thick Straight Shim

Shim Types

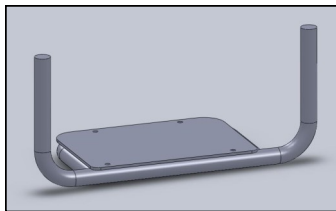
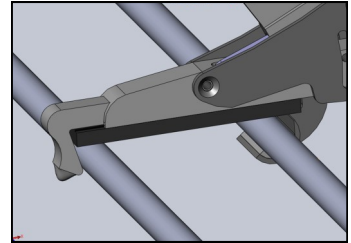

2 TUBE with PLATE

2 Tube with Plate:
Thinnest Straight Shim or
Medium Straight Shim
(depending on thickness of
footrest plate).

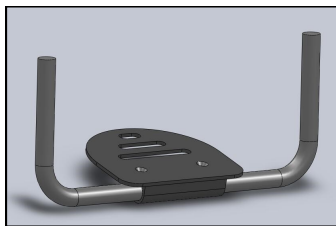
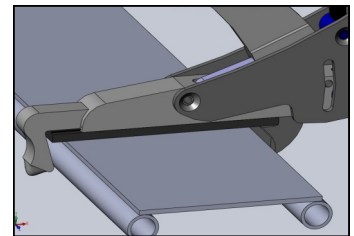

CLAMP PLATE

Clamp Plate:
NO Straight Shim

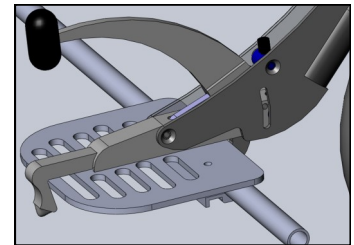

Insert straight shim into dove-tail
feature found in clamp base.

Rear end should be removed.

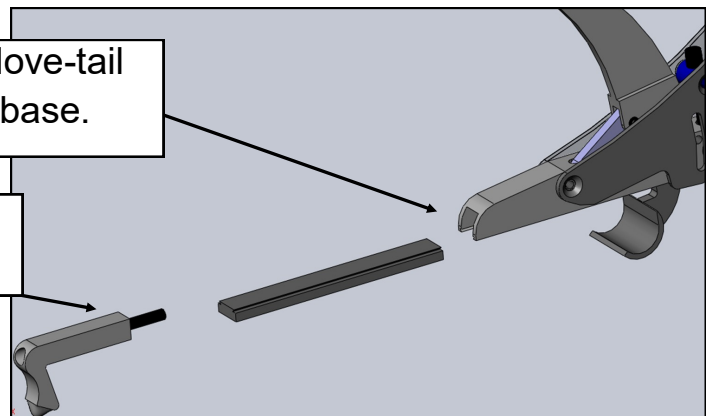

STEP 3: Angle Adjustment to Lift Front Casters

This adjustment makes sure the FreeWheel properly lifts the front casters. The adjustment is based on the height of your wheelchair's footrest from the ground (heights over 4-3/4" require a custom frame FreeWheel). Make sure you have completed the Set-up Guide STEPS 1 and 2, BEFORE you complete this step.

It is best if the person is in the chair, to take their weight into account.

1. Slightly loosen screws A, B and C, BOTH sides, using 5/32" or 4mm allen wrench. Do NOT remove the screws.

2. Find a flat/level floor. While holding the handle, arrange the FreeWheel in the "tail dragger" position (shown below at right).

3. Move your feet apart. The clamp requires 3/4" of space between your feet.

4. Lower the clamp over your footrest, setting it down with clamp cup just in front of the footrest tube.

5. Lock down by putting pressure on the handle. The locking action should feel very solid and secure.

6. The FreeWheel tire should be firmly touching the ground.

7. Tighten or loosen the Angle Bolt (3/16" or 5mm allen wrench) so NO threads are showing.

8. Re-tighten BOTH SIDES of bolts A, B and C.

9. Rotate the tire under the frame, casters will be lifted.

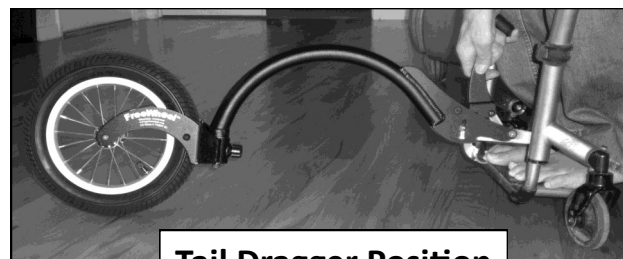
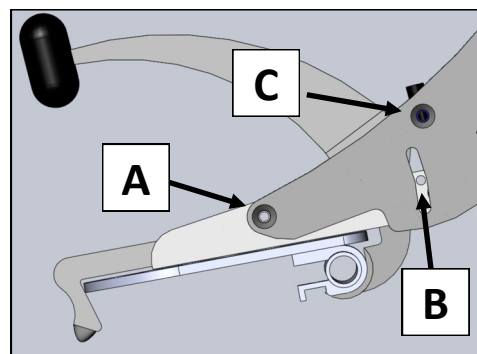

Tail Dragger Position

Angle Bolt

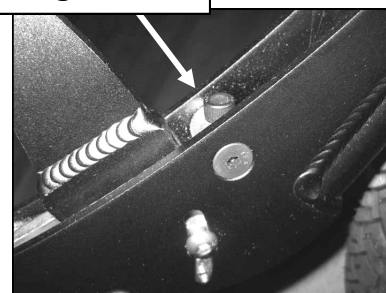

STEP 4: Which Rear End?

(ALL footrest types need a rear end.)

1. Measure from the front tube/plate to the back of the footrest to determine depth. SHORT Rear Ends are for footrest depths of 4" to 5". LONG Rear Ends are for footrest depths of 5" to 6-3/8".
2. With a SHORT Rear End use a hack saw to cut your straight shim the same length as the footrest depth (footrest depths 5" to 4").
3. With footrest depths from 4" to 3-1/2" use these instructions:
 - a. Remove circlip and the 2 1/2" bolt from the rear end.
 - b. Using a hack saw cut 1/4" off of the square end of the rear end then reassemble.
 - c. If a flat shim is used, cut it to the footrest depth.

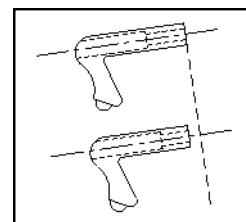
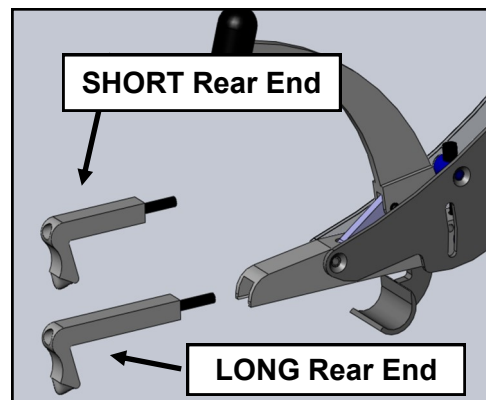

WARNING: Clamping the FreeWheel to your footrest with the Rear End set too short (overly tightened) can damage the Rear End. **Carefully follow Steps 4-6.**

4. Before attaching the FreeWheel to your footrest, insert correct size Rear End into silver brick and **SLIGHTLY TIGHTEN** using a 3/16" or 5mm allen wrench.
5. With the FreeWheel in the "tail dragger" position, clamp to your footrest by hooking the rear end first, then set down FreeWheel so the clamp is just in front of the footrest tube, press down on the handle.
6. Finish tightening the Rear End bolt with FreeWheel on your footrest, so the **Rear End just touches the back of the footrest tube/plate**. Do NOT over tighten. The strength of the front clamp is what holds the FreeWheel to your footrest.

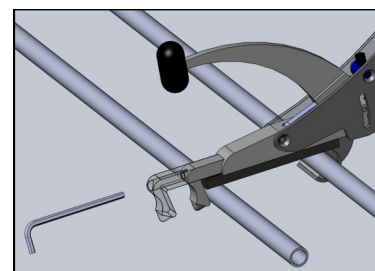

Pinning Instructions for Clamp/Angle Adjust Footrests

To make sure your Clamp Plate/Angle Adjust footrest does not rotate you will need to add 2 screws to lock the clamp holding your footrest plate to the tube. Use two #10-32 Self Threading machine screws, centered, and 3" apart.

Make pilots holes with a 5/32" drill bit. Using a lubricant such as WD40 helps with inserting the screw to lock the clamp (screws only needs to go through front of tube). **Maximum plate angle down is 12 degrees.**

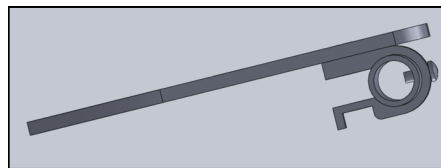
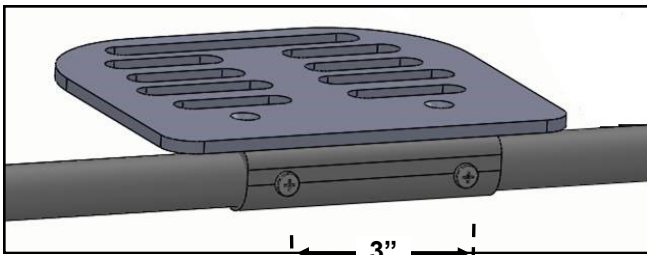

TiLite ONLY Clamp/Angle Adjust Footrest: Special Instructions

With a TiLite Clamp/Angle Adjust footrest it is CRITICAL to have the correct clamp. Your FreeWheel can be damaged if you force it to attach to an incorrect clamp. Part P102 includes the correct clamp, shim and pinning screws.

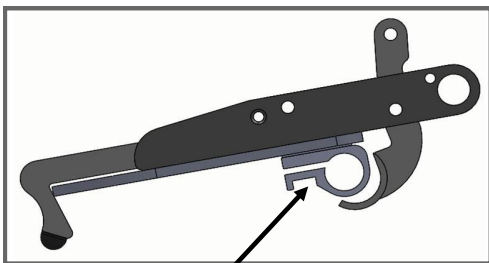

CORRECT TiLite Clamp

If your TiLite clamp looks like the clamp to the left, with a rounded bottom curve, you will only need a shim and pinning screws.

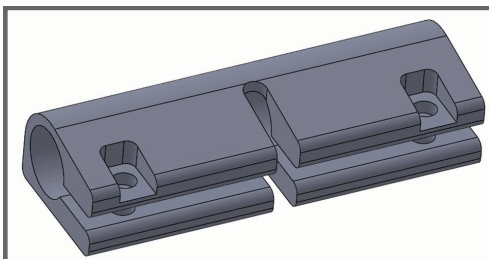
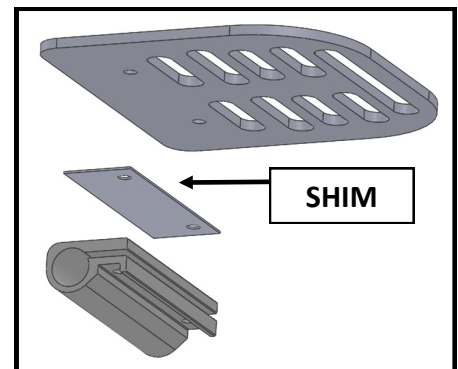

If your TiLite clamp looks like the clamp to the left, this WILL NOT WORK and you will need to order Part P102, which includes a clamp, shim, and pinning screws.

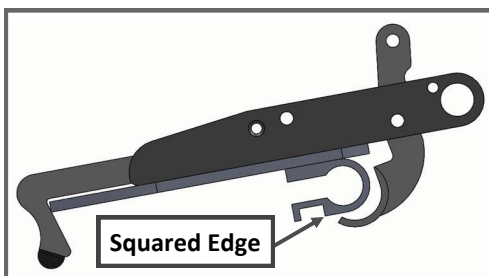

If your TiLite clamp looks like the clamp to the left, with a squared edge at the bottom, you will need to either replace with Part P102 or use a dremel and remove material and curve the bottom (see picture on right).

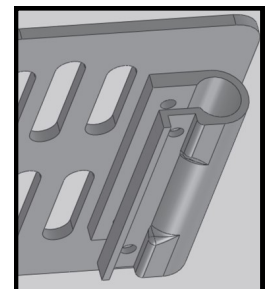

Perch Set-up Guide

To install the Storage Perch on the crossbar on the back of your chair, chose the perch post that matches your footrest set-up. Use a 3/16" or 5mm allen wrench to change post type and to tighten perch on to your cross bar.



ROUND Perch Post — Tube only footrest, with THICKEST straight shim and the cup shim has NOT been removed.

SMALL D Perch Post — Middle thickness straight shim and the cup shim has NOT been removed.

MIDDLE D Perch Post — Thinnest straight shim and the cup shim has NOT been removed.

BIG D — NO straight shim and the cup shim has been REMOVED.

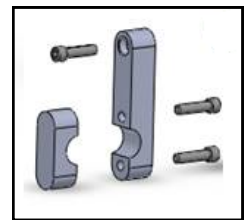

Perch

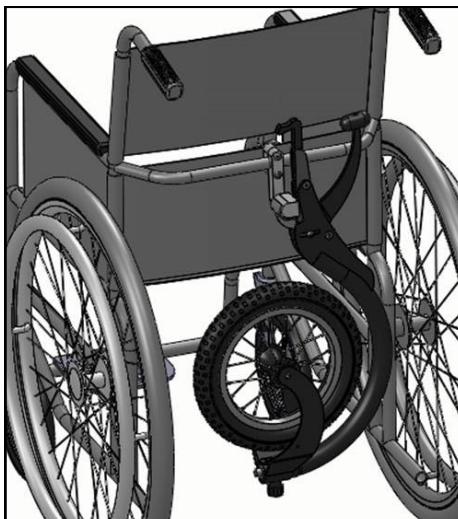

Low Cross Bar

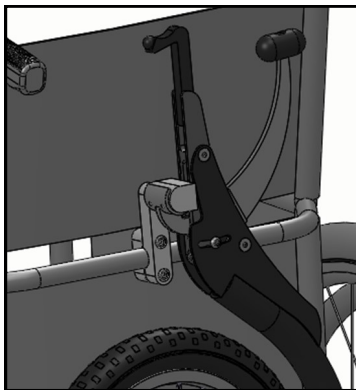

High Cross Bar

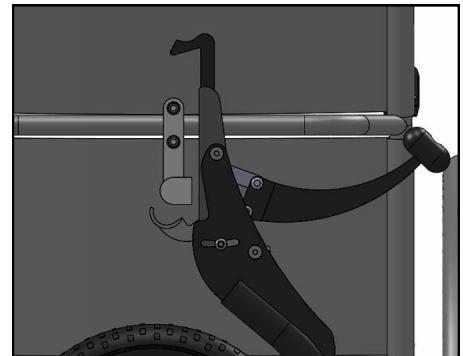

With one hand cupping the clamp of the FreeWheel, hold the clamp to the perch while the other hand grips the handle and firmly close the clamp onto the perch. This takes a little practice.



How to Adjust for Steering

If your Freewheel is not tracking straight when coasting forward on level ground, the steering should be adjusted. To do this you need to adjust two separate fasteners:

Front Set Screw, and; Main Steering Stem Bolt

1. The Front Set Screw secures the steering adjustment.
2. After loosening the Front Set Screw (2.5mm allen wrench) and Main Steering Stem Bolt (8mm allen wrench), rotate the fork to adjust the steering straight. It helps to rotate the tire under the frame 360° clockwise and counter-clockwise, to loosen up the internal mechanism.
3. If the internal bushing is not rotating relative to the frame, then tighten the ball adjuster knob to lock the fork to the internal bushing. Work the bushing loose from the frame. Re-grease this joint by inserting bearing grease under the spring, on the ball bearing, to keep it from binding.
4. Set the steering and then tighten the Front Set Screw.
5. Finish by tightening the Main Steering Stem Bolt. **It is IMPORTANT this bolt is tightened to 20 ft. lbs. with a torque wrench to avoid damaging your FreeWheel.**
6. Test for straightness by coasting on a flat/level surface.

Note: The front ball adjuster knob can be loosened for light steering action or screwed in (tightened) for heavier steering action.

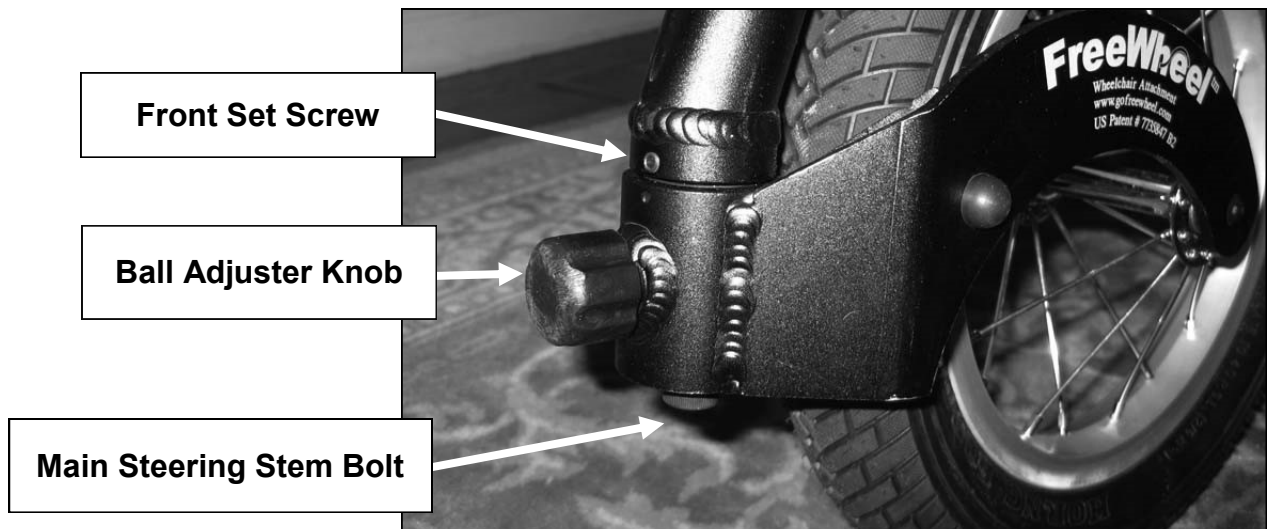

Maintaining your FreeWheel

It is important to maintain your FreeWheel so it continues to provide you with years of enjoyment. It is a good habit that on a regular basis, especially after a long work out, that you check the following:

1. Keep screws **A, B and C** tight using 5/32" or 4mm allen wrench and double checking both sides.
2. Make sure the **Angle Adjust bolt D** is in contact with the silver barrel (adjust with 3/16" or 5 mm allen wrench). You should NOT be able to see any of the Angle Adjust bolt threads
3. **CRITICAL** - Make sure the main **steering stem bolt** is tight. In some cases this bolt will loosen and the FreeWheel will not function properly. Using an 8mm allen torque wrench tighten to 20 ft. lbs. torque. It is important that you use a torque wrench to make sure this properly tightened.
4. Please keep your Freewheel free of dirt, mud and grim, as well as immediately wash off any saltwater should you be near the ocean.
5. Occasionally you may want to put bearing grease on the ball bearing under the front knob (and under the spring).

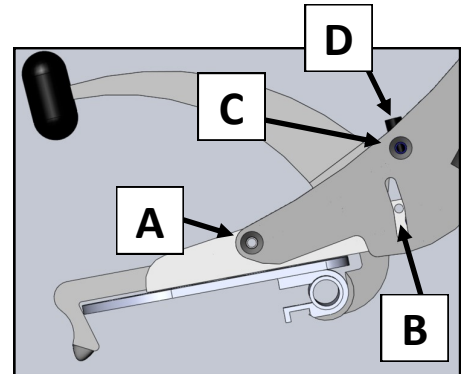

Please do not hesitate to contact us if you have any issues. Our goal is to make sure your FreeWheel is always functions properly.



Wheel Removal for Tire/Tube Change*

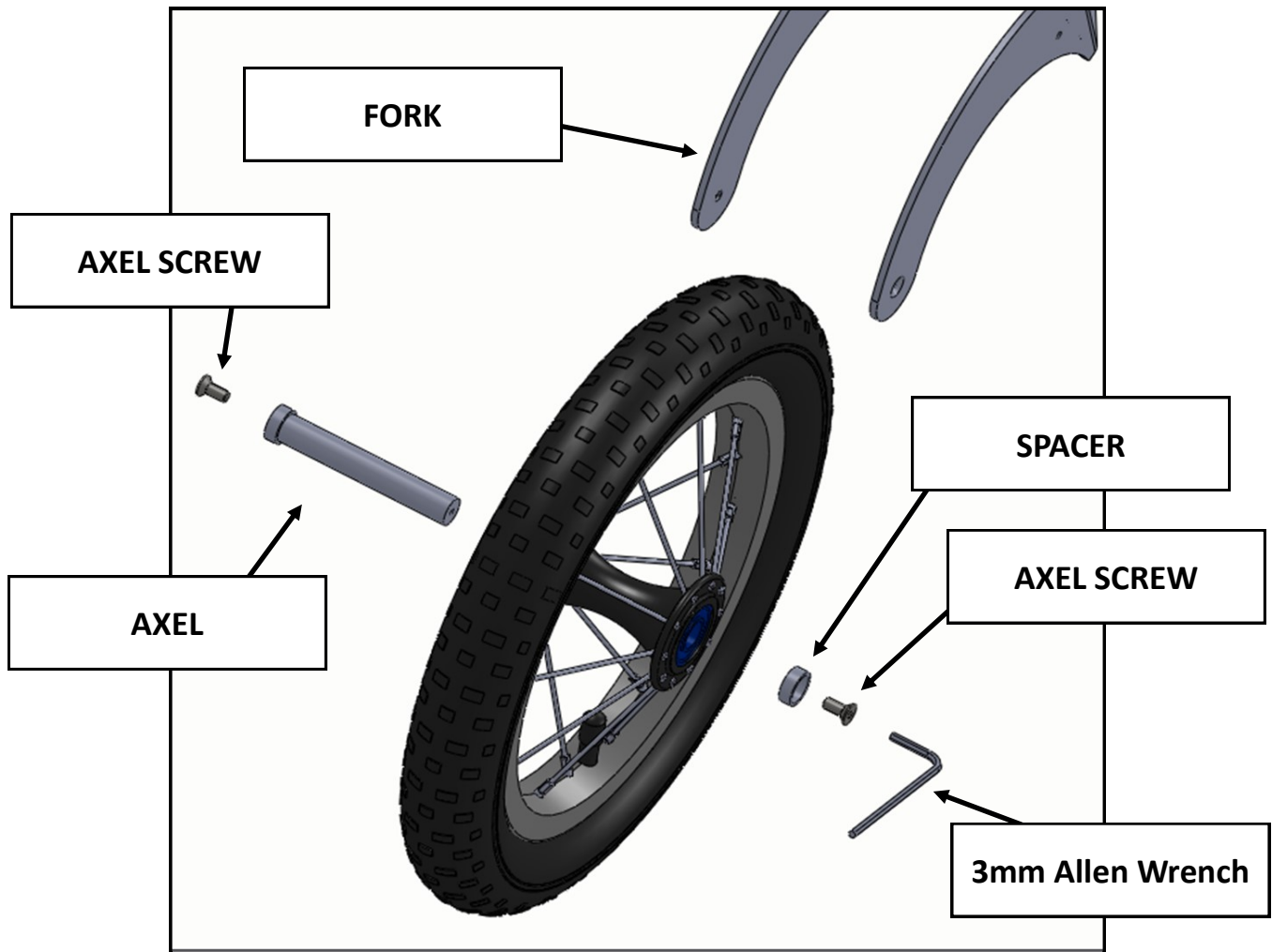

*If your HUB is silver, please refer to the Wheel Removal on our website under the FAQ's Tab at: www.gofreewheel.com.

For an additional information or if you have questions, please contact us at:
info@gofreewheel.com

Thank you for your purchase of the FreeWheel Wheelchair Attachment!





FreeWheel®

Thank you for choosing the FreeWheel Wheelchair Attachment. I am confident you will find it to be the one piece of adaptive equipment that you take everywhere you go.

When I was first injured in a motocross accident (resulted in a C6/7 spinal cord injury) I lay in the hospital wondering how I could be a Dad that actively participated in the lives of my young children.

After leaving the hospital I found my wheelchair more limiting than was acceptable. My front casters would catch on everything and either toss me out of my chair or force me to sit on the sidelines.

After years of testing and input from other wheelchair users, I am happy to now be able to provide the FreeWheel to you. It safely and quickly lifts the front casters off the ground and I am now able to live a more independent active life. With the FreeWheel you will easily roll over curbs, down grassy or dirt slopes, and power through snowy parking lots. My FreeWheel goes everywhere I go and my dream of actively participating in the lives of my children is a reality.

Please feel free to send us your videos and pictures and let us know how the FreeWheel is working for you.

Sincerely,

Pat Dougherty

Patrick Dougherty, Owner/Inventor

PNT LLC

P.O. Box, 10135, Boise, ID 83707, USA

Web: www.gofreewheel.com/Email: info@gofreewheel.com



FreeWheel Warranty and Registration Card

The FreeWheel has a One Year Warranty and a Satisfaction Guarantee. If you do not like your FreeWheel you may return it and receive a refund (excluding shipping/stocking charges).

You must register your FreeWheel to validate your warranty.

Your Serial Number is located on the inside of the FreeWheel fork.

To register on-line go to www.gofreewheel.com

PNT, LLC does not accept any liability or responsibility for any type of injury or damage to an individual or property, resulting from the use of the FreeWheel Wheelchair Attachment, ADAPTOR for Folding Wheelchair, and/or RACK Carry-All that is considered in excess of normal use including, but not limited to use with any electric assist product, speeds in excess of what an individual can normally push on a flat surface when an individual in the wheelchair weighs in excess of 280 lbs. (250 lbs. when FreeWheel used with ADAPTOR) and/or use with the RACK Carry-All when carrying any manner of load over 25 lbs.