



OPERATOR'S MANUAL

WARNING

FAILURE TO FOLLOW SAFE OPERATING PRACTICES MAY RESULT IN SERIOUS INJURY OR DEATH.

- Read this manual completely as well as other manuals that came with your mower.
- DO NOT operate on steep slopes. To check a slope, attempt to back up it (with the cutter deck down). If the machine can back up the slope without the wheels slipping, reduce speed and use extreme caution.
 - Under no circumstances should the machine be operated on slopes greater than 15 degrees.
- ALWAYS FOLLOW OSHA APPROVED OPERATION.
- Stay two cut widths away from slopes, drop offs, ditches and retaining walls.
- DO NOT mow on wet grass. Wet grass reduces traction and steering control.
- Keep all shields in place, especially the grass discharge chute.
- Before performing any maintenance or service, stop the machine and remove the spark plug wire and ignition key.
- If a mechanism becomes clogged, stop the engine before cleaning.
- Keep hands, feet, and clothing away from power-driven parts.
- Keep others off the mower (only one person at a time)

REMEMBER - YOUR MOWER IS ONLY AS SAFE AS THE OPERATOR!

HAZARD CONTROL AND ACCIDENT PREVENTION ARE DEPENDENT UPON THE AWARENESS, CONCERN, PRUDENCE, AND PROPER TRAINING OF THE PERSONNEL INVOLVED IN THE OPERATION, TRANSPORT, MAINTENANCE, AND STORAGE OF THE EQUIPMENT.

Welcome to the Spartan Family

On behalf of my wife Becky and myself, along with all of us at Intimidator, Inc., we would like to officially welcome you to the Spartan Family. We are thrilled that you have chosen to become a part of our team. Whether you have purchased your Spartan Mower for commercial use in your landscape company or you just wanted to have the best mower in your neighborhood, we would like to say, 'Thank You'. Thank you for investing in, what we believe is, the greatest mower on the planet!

We are fiercely loyal to our customers and work hard to provide the highest quality of products, parts, and accessories at the best possible price. We strive to create a unique experience for our customer that will differentiate Spartan Mowers from the rest of the industry. Our Vision is to build the best zero-turn mower on the market. We will continue to work with experts in our field to provide a superior machine that is second to none in power, durability, and performance. Spartan is not your average mower and we have seen it allow owners to Take Command of their yard, their time, and their life!

We look forward to our future together and hope to be partners for as long as there are yards to mow.

Thank you and again, welcome to the family!

Handwritten signatures of Robert and Becky Foster in black ink.

Robert & Becky Foster

Intimidator, Inc.

Owners



Table of Contents

1.0 General Information	4
2.0 Safety.....	4
3.0 Know Your Mower	10
4.0 Mower Operation.....	13
5.0 Adjustments.....	17
6.0 Mower Maintenance	20
7.0 Off-Season Storage.....	25
8.0 Troubleshooting	27
9.0 Error Codes	29
10.0 Service Record.....	30

Quick Reference for Routine Maintenance

Tire Pressure:
Radials: 12 psi
Standard: 15 psi

Oil Type:
Intimidator SYN 5W-40

Hydraulic Fluid:
Parker HT-1000

1.0 GENERAL INFORMATION

Congratulations on the purchase of your Spartan mower. Your machine has been carefully designed and rigorously tested to ensure the maximum in dependability, durability, and quality for years of mowing performance. This manual contains operating, maintenance, adjustment, and safety instructions for your Spartan mower.

BEFORE OPERATING YOUR MOWER, CAREFULLY READ THIS MANUAL IN ITS ENTIRETY.

By following the operating, maintenance, and safety instructions, you will prolong the life of your mower, maintain its maximum efficiency, and promote safe operation.

If additional information is needed, or should you require trained mechanic service, contact your authorized Spartan equipment dealer. When contacting an authorized Spartan dealer be sure to have the model and serial numbers of your product ready. This will allow the representative to service your request as efficiently as possible.

Your mower model and serial numbers can be found underneath the seat on the left side of the mower as shown in: Figure 1.0: Serial Number Location

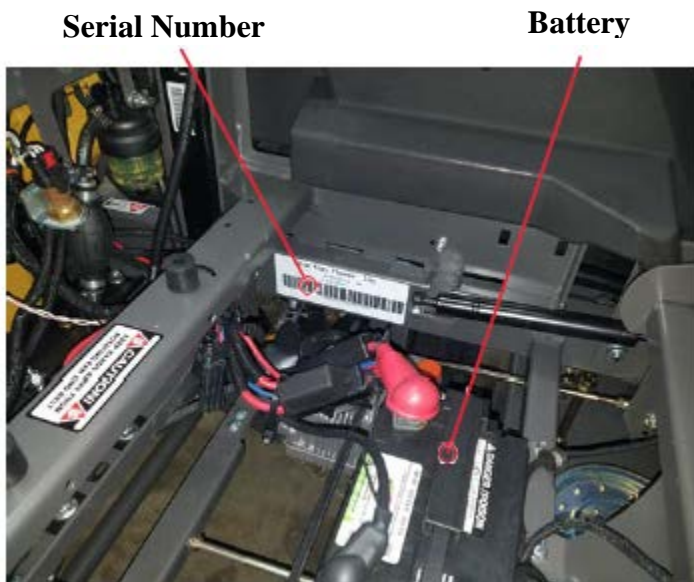

Figure 1.0: Serial Number Location

This manual is included with your mower to help ensure that the machine is operated and maintained properly. Carefully reading and following the instructions contained within this manual will help increase functionality and longevity of your mower. Additional information regarding the engine can be found in the separate Engine Owner's Manual.

Included diagrams were current when this manual was printed but may have changed slightly due to production changes.

Spartan reserves the right to make necessary changes to the design without notifying previous owners. If you notice a change and need updated information contact your Spartan dealer for assistance, or look on-line at:

www.spartanmowers.com. Be sure to check out the 'Owner Info' section under the 'Company' tab.

For servicing, it is encouraged that you utilize your authorized Spartan dealer.

2.0 SAFETY

2.1 Introduction

Read this manual before attempting to operate your mower.

Failure to follow these instructions may result in serious injury or death. This manual is considered a part of the mower and should always be kept nearby.

Your mower is only as safe as the operator. Hazard control and accident prevention are dependent upon the awareness, concern, prudence, and proper training of the personnel involved in the operation, transport, maintenance, and storage of the equipment. Make sure every operator is properly trained and thoroughly familiar with all the controls before operating the mower.

If you need a new manual contact your authorized Spartan dealer to obtain a replacement.

2.2 Signal Words



This symbol means, "**Attention! Become Alert!**" It appears when the following topic is extremely important to safety. Carefully read each message involving this symbol thoroughly and carefully.

SIGNAL WORD:

Signal words are found on the safety decals of the mower and throughout this manual to alert the view to the existence and relative degree of the hazard



"DANGER" indicates that an extremely hazardous situation exists involving the machine that could result in a high probability of death or irreparable injury if proper precautions are not taken.



"WARNING" indicates that a hazard exists involving the machine that can result in injury or death if proper precautions are not taken.

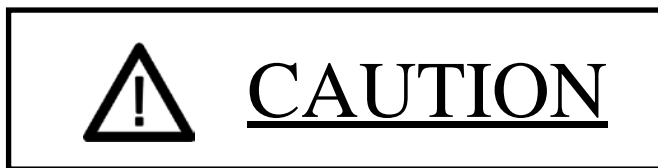

"CAUTION" is a reminder of safety practices involving the machine that could result in personal injury if proper precautions are not taken.

2.3 Considerations Prior to Operation

1. Only allow responsible individuals who are thoroughly familiar with the features and safe operation procedures of the mower to operate this machine.
2. NEVER allow children to operate this machine.
3. DO NOT carry passengers. The mower is a single-rider machine.
4. DO NOT operate the machine under the influence of alcohol or drugs.
5. If the operator(s) or mechanic(s) cannot read English, it is the owner's responsibility to explain this material to them.
6. Clear the area to be mowed of objects that could be picked up and thrown by the cutterblades.

7. DO NOT mow when children and/or others are present. Be alert and turn the machine off if someone enters the mowing area

8. DO NOT wear loose fitting clothing. Loose clothing, jewelry, and long hair can get tangled in moving parts. Wear long pants, safety shoes, safety glasses, and restrain all long hair.

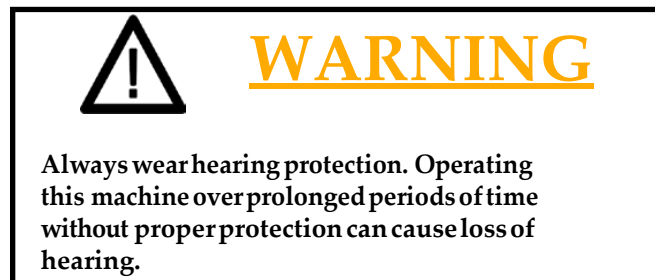

9. Keep the machine and attachments in good operating condition. Keep all shields and safety devices in place. If a shield, safety device, or decal is defective or damaged, repair or replace it before operating the machine.

10. Fuel is flammable; handle it with care. Fill the fuel tank outdoors on a level surface. Never fill it indoors. Use a funnel or spout to prevent spillage. Clean up any spillage before starting the engine.

11. DO NOT add fuel to a running or hot engine. Allow the engine to cool for several minutes before adding fuel.

12. Only use approved containers for fuel and keep flammable objects, open flames, and sparks away from fuel tank and fuel container.

13. Equipment must comply with the latest requirements per ANSI/ASAE S279 when driven on public roads

14. Do not operate mower without the side discharge chute properly installed and in the down position or with an optional grass catcher or mulch plate properly

15. Check the blade mounting bolts at frequent intervals for proper tightness.

16. Make sure all hydraulic fluid connections are tight and all hydraulic hoses and lines are in good condition before starting the machine.

2.4 Safety During Operation

1. Familiarize each operator with all controls and how to stop quickly



WARNING

Under no circumstances should the machine be operated on slopes greater than 15 degrees. DO NOT operate on steep slopes.

ALWAYS FOLLOW OSHA APPROVED OPERATION

2. Exercise extreme caution on slopes and in sharp turns to prevent tipping or loss of control.

3. Stay two cut widths away from slopes, drop offs, ditches, and retaining walls.

4. Start and stop smoothly to prevent tipping or loss of control.

5. Never direct the discharge of material toward bystanders or structures.

6. If the mower discharge chute becomes clogged, shut off the engine and wait for all moving parts to stop before attempting to remove the obstruction.



WARNING

Make sure that there is no one in the operator's seat when removing material from the discharge chute

DO NOT use your hand to dislodge the clogged discharge chute. Use a stick or other device to remove material after the engine has stopped and the blades have stopped moving.

7. Be aware of the mowing environment and terrain. Be alert for holes, rocks, and roots as well as overhead obstructions such as low tree limbs. Inspect the mowing area prior to mowing operations.

8. DO NOT mow in reverse unless necessary. Disengage power to cutter deck and keep a lookout to the rear before backing up.

9. Execute turns slowly and smoothly.

10. Disengage power to cutter deck before crossing roads, walks, or gravel drives.

11. Ensure that the mowing area has adequate lighting for safe mowing operations.

12. NEVER raise the deck with the blades engaged.

13. When leaving the mower unattended, take all possible safety precautions. Disengage the mower, lower all attachments, and set the parking brake. NEVER leave the machine running unattended.

14. Inspect the machine and attachments for damage after striking a foreign object.



CAUTION

DO NOT touch the engine or muffler while the engine is running or immediately after stopping. These areas may be hot enough to cause burns.



DANGER

DO NOT run the engine inside a building or a confined area without proper ventilation. Exhaust fumes are hazardous and contain carbon monoxide which can cause brain injury and death.

15. Keep hands and feet away from cutter blades and moving parts.

16. Transport the mower using a heavy-duty trailer or truck. Ensure the trailer or truck has all the necessary lighting and markings as required by local laws, codes, and ordinances. Properly secure the mower with an appropriately rated strap or chain.

17. Exercise caution when loading and unloading onto trailers or trucks. Use only a single full width ramp at an angle no more than 15 degrees.

18. When transporting the mower, make sure the park brake is engaged, the steering control levers are in the neutral position, the engine is off, and the wheels have been blocked. Tie down the mower using at least two properly rated straps attached to the frame of the mower.

2.5 Roll Over Protection System

(ROPS)



WARNING

Keep the ROPS in the raised and locked position and the seatbelt securely fastened during operation. Failure to do so could cause serious injury or death.

There is no roll-over protection when the ROPS is in the down position.

Lower the bar only when absolutely necessary.

DONOT wear the seatbelt when the ROPS is down.

Always wear the seat belt when the ROPS is up.

The ROPS does not make the mower safe to use on excessive slopes or near drop-offs. It is installed on the mower to prevent severe injury or death in a worst-case scenario.

The Spartan mower has been designed for good traction and stability during normal mowing conditions. When the grass is wet or while operating on slopes the mower performance may be compromised. Do not mow on wet grass as it reduces traction and steering control.

No part of the ROPS should be removed for any reason. The consequences of removing the installed ROPS could result in injury or death.

It is important to regularly inspect the seat belt system. If the seat belt system shows cuts, fraying, extreme or unusual wear, excessive discoloration due to UV exposure, dirt, stiffness, abrasion, or damage to the buckle, latch plate, hardware, or any other obvious problem, the seat belt system should be replaced before any further mowing operations are conducted.



WARNING

Failure to properly inspect and maintain the seat belt system can cause serious injury or death

19. Use care when approaching blind corners, shrubs, trees, or other objects that may obscure vision.

1. Check the entire seat belt strap for indications of cuts, wear, fraying, dirt, or stiffness.

2. Pay close attention to the belt in areas where it is regularly exposed to ultraviolet rays from the sun. If the webbing shows excessive fading the material's strength may be compromised and needs to be replaced.

3. Inspect the buckle and latch for proper operation. If any part of the system is broken or not functioning correctly replace it before the next mowing session.

Roll Over Protection Structure



Figure 2.0: Mower ROPS



WARNING

Reduce speed when turning, operating on slopes, slick or wet surfaces. Allow extra distance to stop

DO NOT operate the mower on slopes greater than 15 degrees.

DO NOT mow near drop-offs, ditches, or embankments.

NEVER tow on slopes

Operate the machine smoothly, no sudden turns, starts, or stops, especially on a slope.

It is important to exercise caution when operating your mower on a slope. Roll over events can occur suddenly and maintaining vigilance is important to keep mower operators safe. Use the included slope gauge to help approximate slope angle. If in doubt as to the safety of a slope, do not operate the mower on the slope. Utilize a push mower or trimmer to trim the grass in that area.

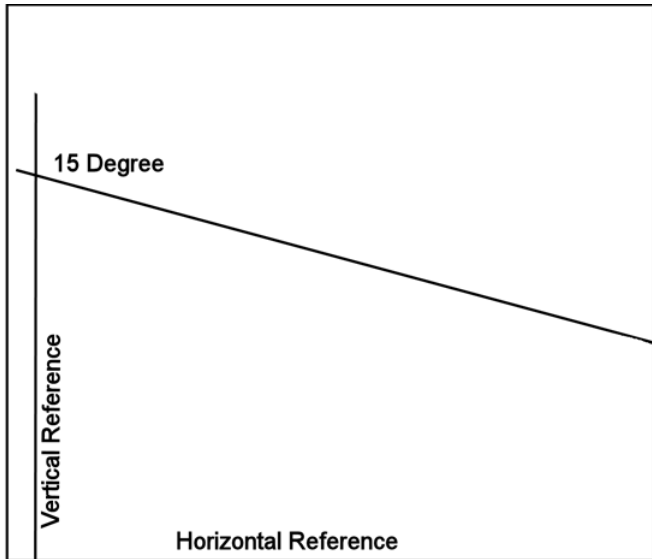



Figure 2.1: Slope Reference

2.6 Maintenance and Storage Considerations

1. Never adjust the machine with the engine running unless specifically instructed to do so. If the engine is running, keep hands, feet, and clothing away from moving parts.
2. Take all precautions to prevent accidental start-up when servicing or adjusting the mower. Disengage all clutches and implements, set the parking brake, stop the engine, and disconnect the spark plug wire. Ensure all movement has stopped before beginning any maintenance.
3. Park the machine on level ground for all maintenance.
4. Check all nuts, bolts, and screws for adequate tightness.
5. Do not change the engine governor settings or overspeed the engine.
6. NEVER allow untrained personnel to service the machine
7. Use care when working with the mower blades.



WARNING

Hydraulic fluid is under high pressure and can penetrate skin causing injury. If hydraulic fluid is injected into the skin, it must be surgically removed within a few hours by a doctor or gangrene may result. Keep body and hands away from pinholes that eject hydraulic fluid under high pressure. **DO NOT** use hands to check for leaks.

Relieve all pressure from the hydraulic system before performing any work on the system.

It is recommended that only an authorized Spartan dealer perform hydraulic system maintenance.

2.7 Safety Warning Decals

NOTE: Safety decals should enhance but not replace the safety information contained within this manual.



WARNING: Thrown Objects hazard.

Never operate the mower deck with the discharge deflector in the upright position or while damaged.

It is acceptable to operate the deck if a bagger or mulching system is used that keeps debris from being discharged away from the machine.



WARNING: Thrown Objects hazard.

Stop the machine if a person enters the work area. Always inspect the area to be mowed for loose debris that could be harmful to the mower or be thrown from the machine. Note any terrain that could cause a loss of control of the machine as well as any non-movable hazards to be avoided.



WARNING: Hot surface hazard.

Do not touch hot surface and keep a safe distance away from hazard



WARNING: Rear Operator's Manual and understand Warning Decals before operating machine.

WARNING: Roll Over

Mow a safe distance (minimum of 10 ft.) away from drop-offs, retaining wall, drainage ditches, embankments, water, and other types of hazards to avoid a wheel dropping off over the edge or avoid the ground from breaking away

WARNING: Back Over

Do not carry passengers. Always stop machine if someone enters the area.

Always be aware of what is behind the machine before backing up. Do not mow in reverse unless necessary. Always look down and behind when backing up.

WARNING: Roll Over

Slow down before turning.

Do not operate on slopes greater than 15 degrees. Keep all movement on slopes slow and gradual. Never make sudden changes in speed and direction.

Do not mow on slopes above a retaining wall or drop-off

WARNING: Ejection



Do not operate on slopes greater than 15 degrees. Keep all movements slow and gradual when going up and down slopes.

Do not remove or modify stabilizer wheel or injury can result.

WARNING: Loss of traction/control on slopes

Shut off blades

Back slowly down the slope when loss of traction occurs.



WARNING: Battery hazard.

Avoid skin contact with battery acid by wearing proper protective gear. Do not overfill battery as this can allow acid to come in contact with skin. Do not allow an open flame near the battery



WARNING: Rotating belts and pulleys hazard.
WARNING: Rotating blades hazard.



WARNING: Rotating parts hazard.

Keep a safe distance away from rotating parts of the machine. Do not put any part of your body near rotating parts of the machine.

3.0 Know Your Mower



Figure 3.0: Front View



Figure 3.1: Cockpit View

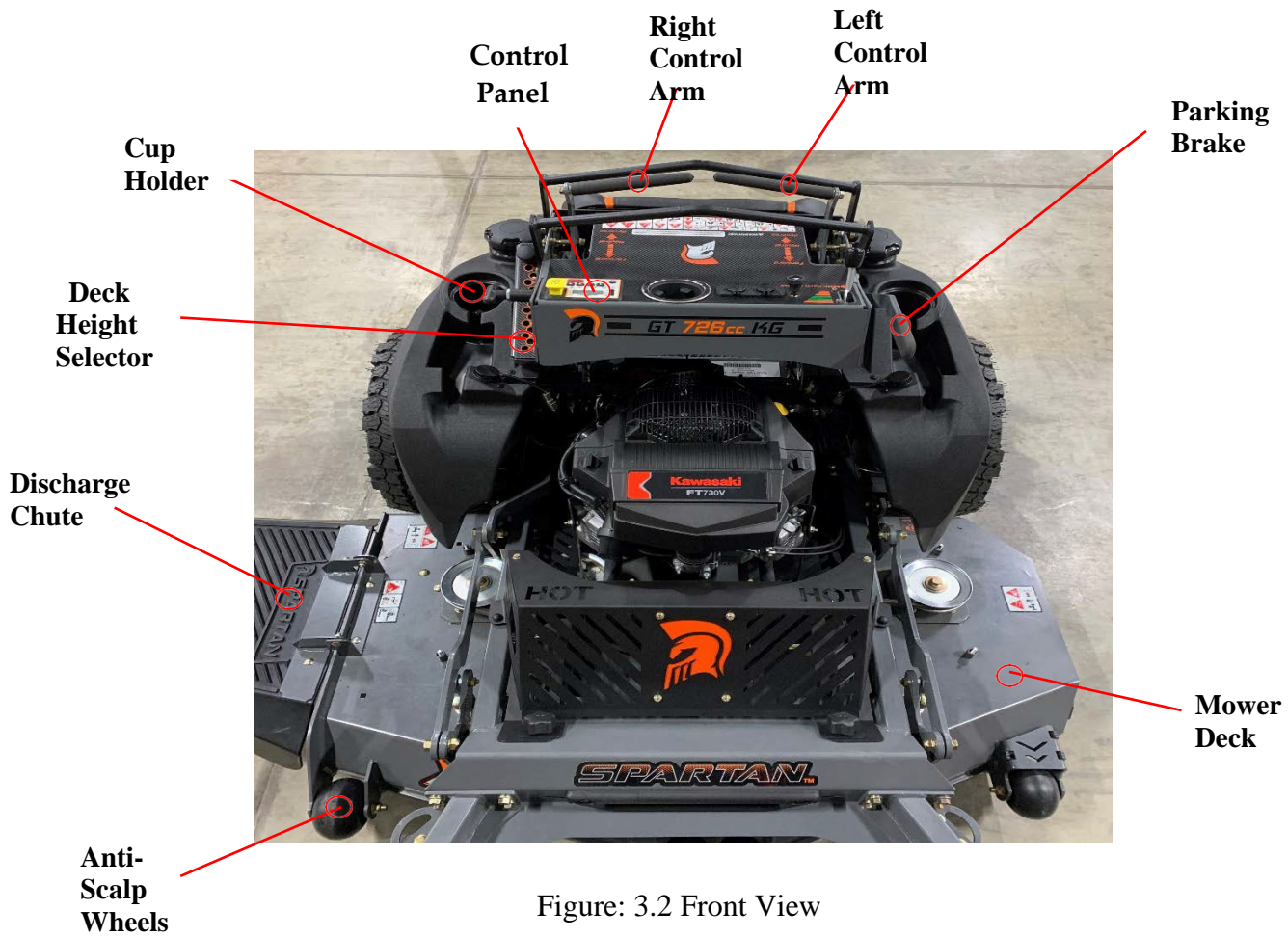

Figure: 3.2 Front View



Figure: 3.3 Cockpit View

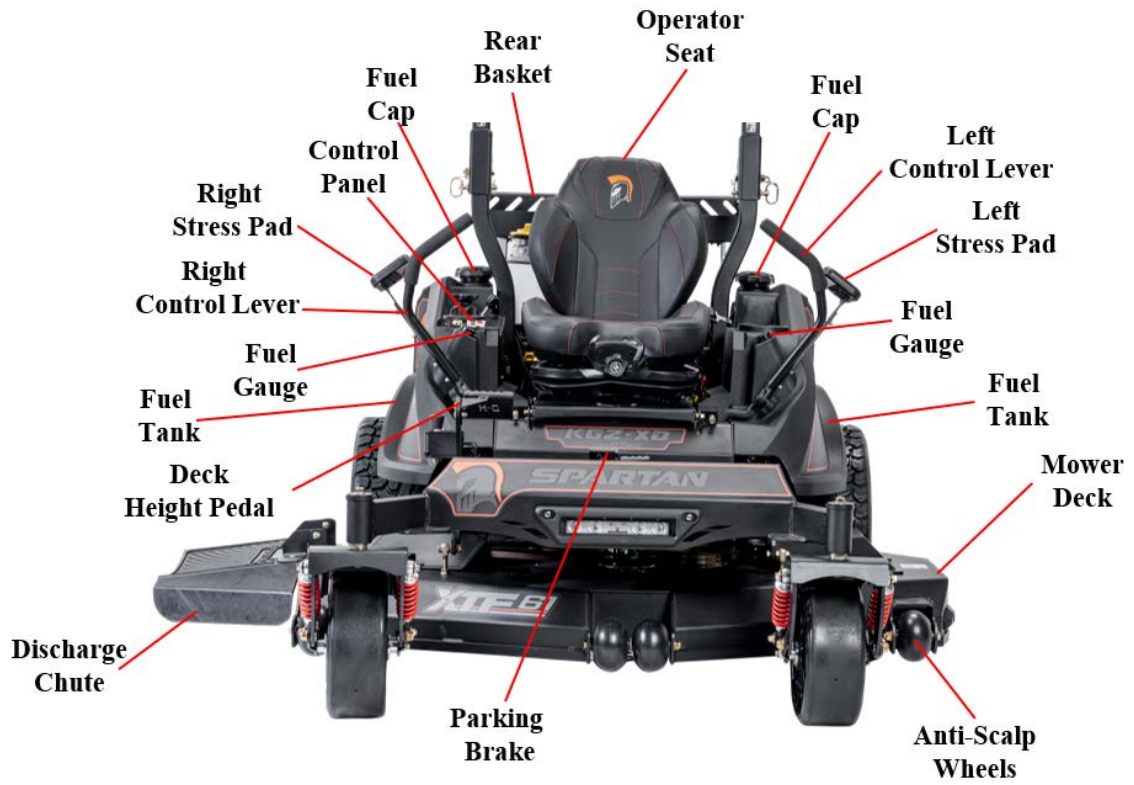

Figure 3.4: Front View

4.0 Mower Operation



CAUTION

DO NOT operate this mower without reading this manual first. Make sure that you know where all of the controls are on the mower and how to use them appropriately.

Review the steps to stop quickly in the event of an emergency.

This section will familiarize you with the features and controls present on the Spartan Mower. To ensure a safe and efficient mowing experience, take the time to review these features and understand their proper use.

4.1 Operation Console

Directly to the right of the operator seat is the central systems control unit known as the Operation Console. This control panel is the hub for all tasks involving mower operation.

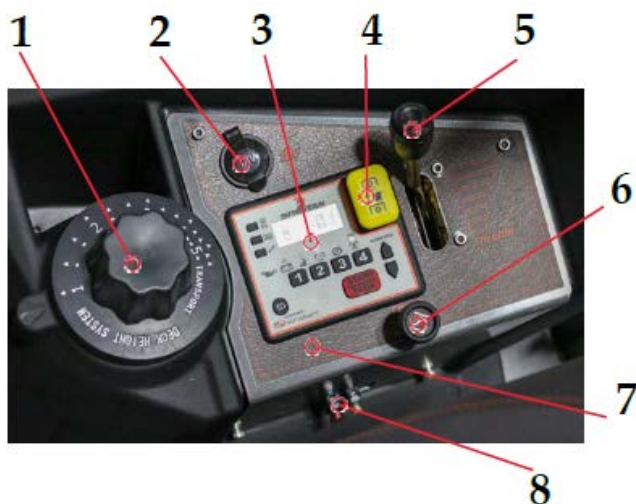

Figure 4.0 Operation Console

4.1.1 Instrument Identification

Deck Height Adjustment Selector

12-volt Auxiliary Plug: Supplies 12-volt power to charge accessories or personal electronic devices.

VersaGuard PRO Console System: Electronic control panel that supplies the operator with a variety of information (covered in the next section).

Power Take-Off (PTO): Disengages the cutter blade system when depressed. Pull out to engage the cutter system.

Throttle Control: Variable control for engine

RPM

Engine Choke (carbureted models)

Fuse Panel

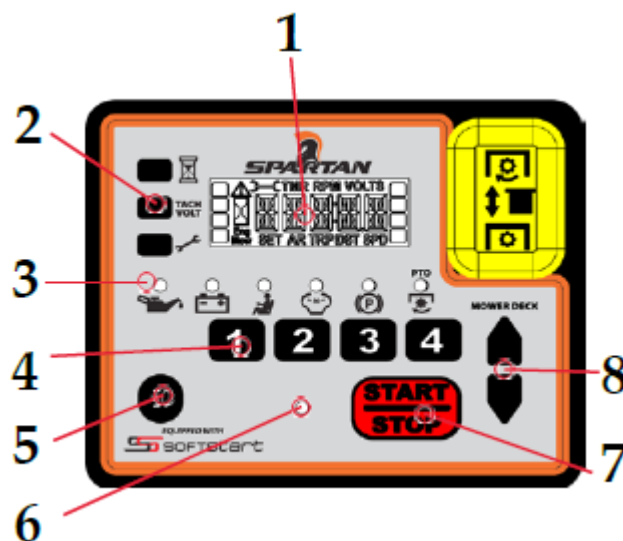

Figure 4.1: VersaGuard Console

1. LCD Information Center:

- Engine hour meter - non-resettable
- Mower hour meter - non-resettable
- Job timer
- Clock
- Tachometer (RPM)
- Voltmeter - 12.0V low/15.0V high warning
- Service Alert - CHG OIL

2. LCD Quick Toggle Buttons:

- Press and release to toggle between modes
- Press and hold for 6 seconds to reset/clear (Display shows "00000" when reset)

Note: Console must be powered up to reset the Job Timer and Service Alert

3. LED Indicators (left to right):

- Oil Alert - Low engine oil pressure
- Battery Alert - Voltage below 12V or above 15V
- Operator Seat Indicator
- Neutral Indicator
- Parking Brake Indicator
- PTO Disengage Indicator

4. Keypad: Used to unlock and power up the console.

5. Headlight Button (when equipped): Press to turn headlights on or off (must have headlights installed. Contact your dealer to purchase this accessory).

6. Safe-To-Start Indicator LED: This light will glow red to indicate that startup parameters are not met. It will glow green when:

- Operator is in the seat
- Parking brake is engaged
- Drive Levers are in neutral
- PTO is disengaged

When the light glows green it is safe to start the mower.

7. Start/Stop Button: When startup parameters are met, pressing, and holding this button will start the engine. Release once the engine starts.

Press the Start/Stop Button once to stop the engine.

8. Mower Deck Lift Button (when equipped): Use the up and down buttons to raise or lower the mower deck respectively (must have power deck lift installed. Contact your dealer to purchase this accessory).

4.2 Safety Start Interlock System

The Spartan mower boasts a safety interlock system that prevents unsafe starting and/or operation. It prevents the engine from operating unless the operator is in the seat, the steering control levers are in the neutral position, the parking brake is engaged, and the PTO is disengaged. The system's function is to shut down the engine if the operator leaves the seat with the cutter blades engaged and/or the steering levers not in the neutral position and the parking brake not engaged.



WARNING

DONOT disengage or bypass any part of the safety interlock system.

NEVER operate the mower if the safety interlock system is disconnected normal functioning.

4.3 Start-up and Shutdown

1. Begin by entering your personal code into the Spartan console using the number pad. Changing this code is discussed in a later section. When the correct code is entered, the hours of operation will be displayed, and panel lights will turn on.

NOTE: If the incorrect code is entered, **WRONG CODE** will flash on the display. The correct code must be entered before the mower can be operated.

2. Before the mower will start, the Safe-To-Start Indicator must be green.

- 2.1 Sit in the operator's seat
- 2.2 Engage the parking brake
- 2.3 Place control arms into the neutral position
- 2.4 Disengage the PTO

Once these parameters are met, the Safe-To-Start Indicator will turn green.

3. If your model is carbureted, pull the choke plunger out to its maximum height.

4. Press and hold both sides of the START/STOP button to start the engine. Release the switch when the engine starts.

5. Once the engine is running, press the choke plunger back down to its lowest setting. If the weather is cold, the engine may need to run for a minute before the choke can be depressed.

NOTE: There are two switches under the START/STOP button. Both switches must be pressed to start the engine. Only one switch must be pressed to stop the engine.

Shut Down Procedure

1. Safely park the Spartan (**see 4.3.3**)

2. Disengage PTO, place control arms in neutral position, engage parking brake, reduce throttle to lowest setting.

3. For diesel models: Allow the engine to idle on low throttle (no more than 1/2) for at least 3 minutes.

4. With the throttle at its lowest setting, press the START/STOP button and wait until all moving parts of mower have stopped before dismounting.

4.3.1 Personalizing Your Key Code

The start-up code can be changed by the owner. Be sure to record your new start-up code. Only a Spartan dealership can reset a lost or forgotten code. The start-up code must be 1 to 12 digits long.

1. Ensure that the engine is stopped and that the PTO is disengaged (down position).

2. Unlock the console with the current start-up code.
3. Hold buttons 1 and 2 down until "CHNGE CODE" is shown, followed by a blank screen.

4. Enter the new key code into the console using the number buttons. If the code is more than five digits long, only the last five digits pressed will show on the display. **NOTE:** If more than 12 digits are entered the display will show "FULL".

5. Pull up on the PTO switch. If the new code is accepted the message "ENTER CODE AGAIN" will be displayed. Immediately reenter the new code and push the PTO switch down. If the system times out, begin again at step 3.

6. If the new code is entered correctly both times the display will show "SAVED CODE" and the new code is activated. If the codes do not match, "NO MATCH" will show and the operator must go back to step 1.

Some codes are not usable within the console system. If this is the case, "BAD CODE" will show when the PTO switch is pulled up. Push the PTO switch back down and begin again with step 1.

If the PTO switch is pulled without entering a code, "EMPTY CODE" will show. Start again with step 1.

If no input is entered for 10 seconds, "TIME OUT" will be displayed. Start again with step 1.

4.3.2 Setting the Clock

1. Unlock the console using your start-up keycode.
2. Press the hourglass button repeatedly until the time-of-day clock is displayed.
3. Press and hold the hourglass button until "SET" appears on the display. Release the hourglass button. The time will flash
4. Use the number 1 and 4 buttons to change the time down and up respectively. Holding the button instead of pressing and releasing will change the time more rapidly.
5. Once the correct time is set, press the hourglass button once to save

4.3.3 Resetting the Job Timer

1. Press the quick toggle button next to the hourglass symbol to scroll through the timers to the Job Timer.
2. Press and hold the hourglass button for 6 seconds until the Job Timer reads "000000"

4.3.3.1 Resetting Oil Change Alert

1. Enter your personal code to access the console
NOTE: Do not start the mower
2. Press the wrench quick toggle button to select the oil change timer
3. Press and hold the wrench quick toggle button until the display shows "000000."

4.4 Traveling, Maneuvering, and Mowing

IMPORTANT:

Zero-turn mowers handle differently than other forms of equipment and vehicles. It is important that you familiarize yourself with the handling and operation of your mower in a safe, controlled area before moving on to mowing. Find an open area, away from buildings, fences, or obstructions to practice maneuvering the Spartan and keep the travel speed low until you build familiarity and confidence.

A good analogy to keep in mind is that of maneuvering a shopping cart. If the control arms are like the handlebar on a shopping cart, then the inputs to make the cart move in different directions are the same as the inputs for the Spartan mower.

Make all inputs slowly and smoothly. Smooth inputs will translate to a smooth ride.

Be sure you are comfortable with the controls before engaging in mowing operations.

Traveling Forwards

To travel forward, disengage the parking brake, pull the control levers out of the neutral position, and slowly push both levers forward equally. Speed of the wheels is determined by how far forward each lever is pressed. To increase speed, push the levers further forward.

To stop, simply pull the levers back to neutral.

To turn left while moving forward, draw the left control arm backwards.

To turn right while moving forward, draw the right control arm backwards.

Traveling In Reverse

To travel in reverse, disengage the parking brake, pull the control levers out of the neutral position, and slowly pull both levers backwards equally. Make sure you have good visibility behind the mower and travel slowly while in reverse.

To stop, simply push the levers back to neutral.

To turn left while moving in reverse, press the left control arm forwards.



CAUTION

DONOT mow in reverse unless absolutely necessary. Always disengage the PTO and scan for obstacles/people before attempting to move in reverse.

4.4.1 Engaging Mower Blades

1. Press the "Tach/Volt" button on the mower console to bring up the tachometer.
2. Move the throttle lever upwards until the RPMs are at least 3000, but do not increase past 3200 RPM. **NOTE:** Diesel models have a maximum RPM of 2800. Engage the mower blades at 2400 RPM and increase to 2800 before mowing.
3. Pull up on the yellow switch on the console to the engaged position.
NOTE: As the clutch plates engage to transfer energy from the engine to the mower blades there may be a squealing noise. This is normal.
4. To disengage the mower blades, press the yellow switch on the console back down to the disengage position.
5. While mowing, always run the engine at full throttle. The mower is designed to cut most effectively with the throttle at maximum. If the engine begins to bog down, vary your travel speed to allow the mower to cut at maximum RPM.

4.4.1.1 Removing Clogged Material



DANGER

NEVER PUT ANY PART OF YOUR BODY INTO THE DISCHARGE CHUTE FOR ANY REASON!

Completely shut down the mower. Use a stick or other long implement to remove any clogged material and then resume normal mowing operations.

4.4.2 Adjusting Mower Deck Height



WARNING

DONOT adjust the mower deck height with the cutting blades engaged. Only adjust the cutting height **AFTER** disengaging the PTO.

For models equipped with the rotary selector:

1. Disengage the mower blades
2. Press the deck height adjustment pedal all the way forward with your right foot and hold it in place.
3. While holding the pedal down, use your right hand to turn the deck height adjustment knob to the desired cut height.
4. Once the desired height has been selected, slowly release the foot pedal.

For models with the pin selector:

1. Disengage the mower blades
2. Press the deck height adjustment pedal all the way.
3. Move the deck height selector pin to the desired cutting height hole.

Press the deck height adjustment pedal all the way to unlock, and slowly lower it to its new cutting

NOTE: For mower equipped with both rotary and pin selectors follow both instructions and ensure rotary and pin selector match in height.



Figure 4.2 Deck Height Selectors

4.4.3 Towing

To turn right while moving in reverse, press the right control arm forwards.



WARNING

Exercise caution while towing equipment with your zero-turn mower. Because of its unique handling abilities, severe injury and/or damage to property could result from improper towing practices.

NEVER allow passengers in towed equipment.

1. Only tow if your machine has a hitch designed for towing operations. Only attach equipment to the appropriate hitch point.
2. NEVER tow on slopes.
3. Travel slowly and allow extra distance for stopping.
4. Follow all manufacturer instructions for towed equipment.
5. Performing zero-radius turns with equipment attached to the tow points may cause damage to the equipment and to your mower.

4.4.4 Parking

1. With the mower blades disengaged, select a level surface on which to park the mower. **DO NOT** park on a slope.
2. Position control levers in the neutral lock position.
3. Reduce the throttle to idle speed (lowest setting).
4. Lock the parking brake.
5. Press the "START/STOP" button on the console.
6. Remain in the operator's seat until all moving parts of the mower have stopped.

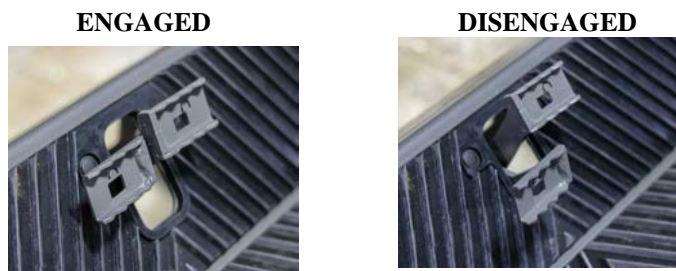

Figure 4.3: Parking Brake

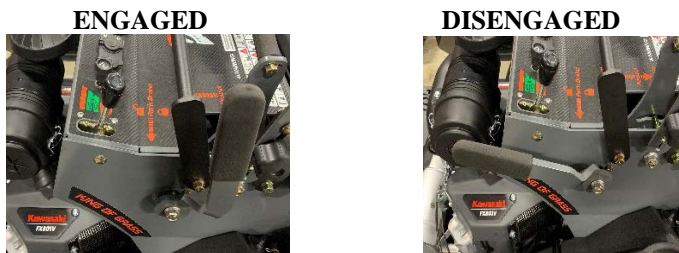



Figure 4.4: Parking Brake

4.4.5 Transporting Your Spartan



WARNING

Use extreme caution while executing all operations involved in the hauling of your Spartan mower such as: Loading, unloading, and transportation.

Use only a single, full width ramp; Do not use individual ramps for each side of the machine.

1. Be sure to utilize a trailer that is properly rated to haul the weight of your spartan mower
2. When loading and unloading your mower, make sure that the ramp angle does not exceed 15 degrees between the ramp and the ground.
3. Be sure to secure the mower using at least two appropriately rated straps or chains attached directly to the frame, being sure to follow the manufacturer's recommendations.
4. Make sure that the control arms are in the neutral position, the parking brake is engaged, and the wheels have been blocked.

5.0 Adjustments

There are multiple features on your Spartan that are adjustable to suit the needs of different operators. Before making any of these adjustments, make sure that your machine is parked on level ground with the engine off, PTO disengaged, and parking brake on.

5.1 Seat Adjustment

Basic Seat

1. Pull the seat adjustment lever under the left side of the operator's seat out to the left

2. Slide the seat forward or backward to the desired position.
3. Release the lever to lock the seat in place.

Seat Adjustment Lever



Figure 5.0: Seat Adjustment Lever

Spartan Suspension TecSPak Seat

1. For forward and backward adjustment, follow the steps for the **Basic Seat**.
2. To adjust the seat for varying operator weight first raise the seat. Locate the seat release lever at the back-left of the operator's seat. Press the lever down and press the seat forward to access the chassis.
3. Beneath the seat is the seat base assembly which includes two black rubber cones. Adjusting these cones forward and backward will allow you to customize the seat suspension for operators of varying weights.

Suspension Cones

Adjustment Scale

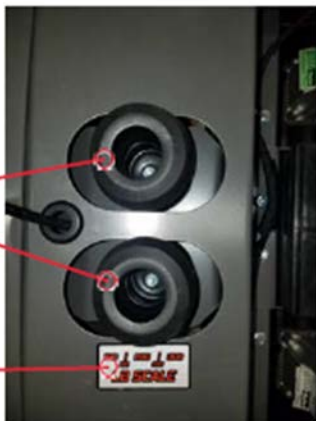

Figure 5.1: Seat Suspension

4. To adjust the cones, loosen the soft grip knob located underneath each cone.
- NOTE:** only loosen the knobs enough to allow the cones to move.
5. Move the cones forward or backwards to align them with the appropriate weight setting as indicated by the measurement decal. Make sure that the cones are aligned evenly.
 6. Tighten the cone knobs and lower the seat back into place.

5.2 Adjusting the Control Levers



WARNING

DO NOT adjust any part of the control lever assembly while the mower is running. Safely park the mower and shut it down completely before attempting any adjustments.

NOTE: The control levers are only adjustable if your mower is equipped with the Soft Knob Adjustable Arms.

1. Adjust the seat to the ideal position
2. Loosen the soft knob on the lever assembly.

Soft Knob



Figure 5.2: Control Lever Knobs

3. Adjust the top portion of the control lever to the appropriate operating position.
4. Tighten the soft knob and repeat on the opposite lever. Ensure that the levers are even before operating the mower.

5.2.1 Adjusting Control Lever Input

If you begin to experience creep in either wheel while the control levers are in their neutral position, you may need to adjust the linkage between the control levers and the hydraulic transmissions.

1. Locate the drive arm rods located beneath the operator's seat on either side of the mower.

Drive Arm Linkage



Figure 5.3: Drive Arm Linkage

2. To adjust the length of the rods, loosen the hex nuts at both ends of the rod.
3. Rotate the rod body to either lengthen or shorten the assembly depending on the adjustment required.
4. Once the adjustment is finished, tighten the hex nuts at both ends of the drive rod assembly.

After adjustment, check that the drive arms are even while in the neutral position and that any creep or track issues have been resolved. Both drive arms should be allowed to move forward and backward with a full range of motion.

If any issues persist or the drive rods are unable to be adjusted due to damage, contact your authorized Spartan dealer.

If you notice that the mower tracks left or right when both levers are pressed forwards an equal amount, the drive arm stops may need adjustment. Before adjusting the drive arm stops, ensure that your tires are inflated to the appropriate pressure.

Control Lever Stop



Figure 5.4: Control Lever Stop

1. If the mower tracks left during forward movement, the right-hand wheel is traveling faster and must be limited to correct the issue. Locate the drive arm stop on top of the mower seat base assembly.
2. Loosen the lock nut and adjust the bolt in or out as needed
3. Tighten the lock nut and test the mower travel to ensure that the issue has been resolved.

5.3 Deck Leveling

NOTE: It is especially important to park your mower on flat, level ground for accuracy of the deck leveling procedure.

1. Begin by raising the deck to its highest position
2. Locate the four deck mounting brackets, shown below in the red boxes.

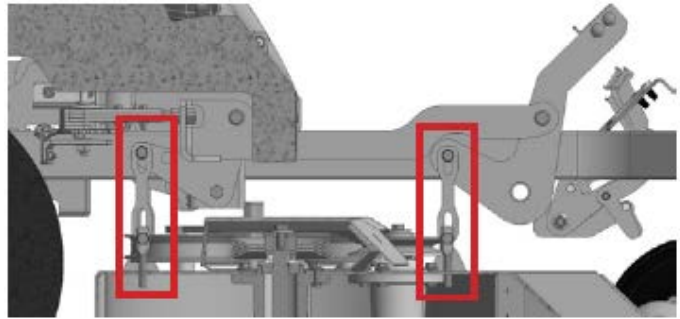

Figure 5.5 Deck Mounting Hardware

3. For RT/SRT models, loosen the nut located flush with the top of the mower deck to allow for adjustment. For RZ models, loosen the nut on the outside of the deck mounting bracket to allow for adjustment.

Loosen this nut to allow for adjustment of the deck



Figure 5.6: RT/SRT Mounting Hardware

Loosen this nut to allow for adjustment of the deck



Figure 5.7: RZ Mounting Hardware

4. Beginning with the rear mounting hardware, adjust the nuts on the inside of the deck up or down to raise or lower the deck. The bottom of the rear edge of the deck should measure **4 3/4"** to the ground. Double check that both sides of the deck match this measurement, and then tighten the top nuts.

5. Adjust the bottom nuts for the front of the deck in the same manner as the rear. the front edge of the deck should measure **4 1/2"** to the ground. Double check both sides of the deck for evenness and tighten the top bolts.

5.4 Moving a Stalled Mower

1. Locate the bypass valves on each hydrostatic drive unit underneath the mower. The area is highlighted below



Figure 5.8: Transmission Location



Figure 5.9 Transmission Dump Valve

2. When looking at the drives from the front, the bypass valve levers will both point to the right when the mower is operating normally.

3. Move both levers to the left. This will put the drive units into neutral.

4. Move the mower by hand to the desired location.

5. Switch the bypass valve levers back to their original positions.

5.5 Parking Brake Adjustment

If you notice that the parking brake will not lock into place, slips out of lock, or is impossible to depress fully it may need adjustment.

1. The mower's parking brake linkage, which connects the parking brake pedal assembly to the parking brake bracket, is located under the operator's seat.

2. The adjustable portion of the linkage is found between the two hydraulic drives where the link meets the parking brake bracket.

3. Loosen the nut on the front of the bracket. Tighten or loosen the rear nut to lengthen or shorten the linkage depending on your requirements.

4. Re-tighten the front nut to secure the assembly.

5. Before operation, test the parking brake to ensure that it is functioning correctly.

Parking Brake Linkage

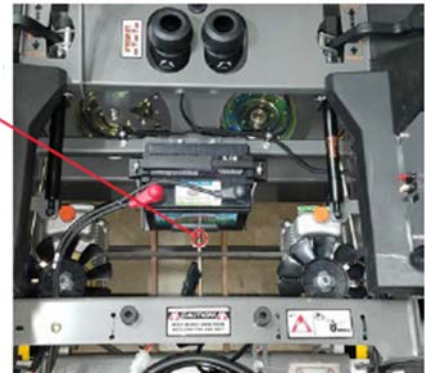

Figure 5.10: Under Seat View

6.0 Mower Maintenance

Regular maintenance is the best method to prevent expensive major repairs or extended downtime. This section covers suggested maintenance procedures that should be performed on a regular basis. All replacement parts must be OEM parts obtained through authorized Spartan dealers. **NOTE:** Always practice good safety habits while performing any maintenance. Refer to section: 2.0 Safety for more detailed safety information.

6.1 Best Practices

Pay close attention to your mower during all mowing operations. Remain alert for any unusual noises, poor handling, or any other signal that there is a problem with the mower system.

Inspect the mower before each use for excess grease, dirt, grass clippings, loose wires, loose hose connections, or any other abnormal conditions.

The maintenance schedule applies to normal operating conditions. If you operate your mower under severe conditions, such as sustained high-load, high-temperature operation, unusually wet, or dusty conditions, consult your servicing dealer for recommendations applicable to your individual maintenance needs.

6.2 Tires

For accurate and consistent mow quality, keep the tires properly inflated to the recommended pressure:

Front Wheels: 8 psi

Rear Wheels: 12 psi

NOTE: Tweels do not require to be inflated.

Any tire replacement must be an approved tire purchased from an authorized Spartan dealer. Warranty claims will be denied on any mower equipped with unapproved tires.

6.3 Lubrication

Use SAE multi-purpose grease for lubrication on:

- Deck lift block
- Anti-scalp wheels
- Deck idler pulley
- Pump idler pulley

Deck Height Zerk



Figure 6.0: Deck Height Zerks

Deck Idler Zerk



Figure 6.1: Deck Idler Zerk

Pump Idler Zerk

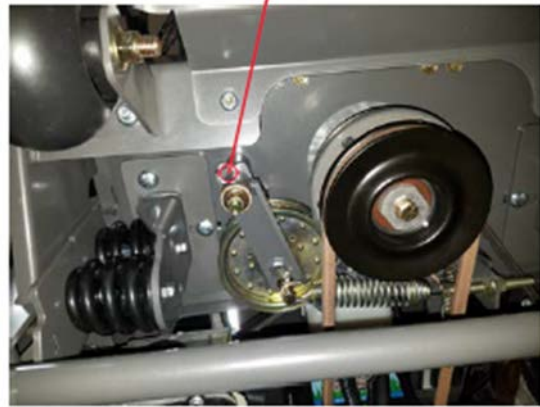

Figure 6.2 Pump Idler Zerk

6.4 Electrical System

The Spartan mower electrical system is a 12-volt, negative ground. Recommended battery:

Garden tractor BCI group 45 with a 480 or higher cranking AMP rating.

Master Fuse

Master Fuse

Battery

Positive Terminal Leads



Figure 6.3: Master Fuse

The Spartan has a 30-amp main fuse located on the positive battery lead. The main fuse provides protection for the entire electrical system.

Electrical System Fuses

The fuse array is in the gap between the operator's seat and the right-hand console. Your mower will have between two and four fuses

Each fuse protects an individual system on the mower. If an electrical system fails on your mower, be sure to examine the fuses and replace any that are tripped using an appropriate replacement.

6.4.1 Battery Care



WARNING

Lead-acid batteries produce flammable and explosive gases. Provide proper ventilation and **DO NOT** expose the battery to any kind of flame, arc, or ember.

Battery posts, terminals, and related items contain lead which is known to cause cancer and reproductive harm. Wash hands after handling.

Electric storage battery fluid contains sulfuric acid which is poison and can cause SEVERE chemical burns. Avoid contact with battery fluid and do not tip any battery beyond 45 degrees.

Call the American Association of Poison Control Centers if contact with battery fluid occurs immediately at 1 (800) 222-1222.

6.4.1.1 Charging the Battery

Refer to the battery charger's manual for more specific instructions

If the mower's alternator is operating normally the battery will maintain a charge through normal operation. If the battery has been completely discharged for an extended period, the alternator may not be able to recharge the battery and a battery charger will be required.

NOTE: DO NOT charge a frozen battery as it may explode and cause injury. Allow the battery to warm up before attaching it to a charger.

Remove the battery from the machine whenever possible to charge the battery.

6.4.1.2 Jump Starting

Make sure that the booster battery used for jumping is a 12-volt type. If a vehicle is used to jump start the mower it must have a negative ground system.

1. Connect the positive cable to the positive battery post.
2. Connect the negative cable to the negative battery post.
3. Jump start the mower with the battery or start the vehicle to be utilized and then start the mower.
4. Remove the negative cable from the negative battery post.
5. Remove the positive cable from the positive battery post.

6.5 Hydraulic System



WARNING

Hydraulic fluid is under high pressure and can penetrate skin causing injury. If hydraulic fluid is injected into the skin, it must be surgically removed within a few hours by a doctor or gangrene may result. Keep body and hands away from pinholes that eject hydraulic fluid under high pressure. **DO NOT** use hands to check for leaks.

Relieve all pressure from the hydraulic system before performing any work on the system.

It is recommended that only an authorized Spartan dealer perform hydraulic system maintenance.

Important: NEVER use non-recommended fluid in this system. Only use Parker HT-1000 Hydraulic Fluid. Remember, dirt is the primary enemy of a properly functioning hydraulic system.

Only check hydraulic oil when the system is cold. If the mower has been operating, allow it to cool for at least 2 hours.

To check hydraulic oil level park the mower safely on a flat surface. Wipe dirt and debris from around the reservoir cap and remove the cap. The dipstick should indicate 1/16"-1/8" if the oil level is correct.

6.6 Fuel System



WARNING

Use extreme care when handling gasoline. Gasoline is extremely flammable, and the vapors are explosive.

DO NOT remove the fuel cap or attempt to fill the fuel tank while the engine is running or while the engine is hot.

Keep all flames and sparks away from fuel.

Over filling the fuel tank could result in dangerous spills or property damage. Clean up all spills immediately.

Your mower's fuel tank is located on the left side of the operator's seat. The fuel capacity for your mower depends on the model:

- RZ - 5 gal.
- RZ-HD and RT - 9.5 gal.
- SRT - 9.5 gal.
- KG- 12 gal.
- KGZ- 16 gal



Figure 6.4: Fuel Structures

6.7 Engine Maintenance



WARNING

Engine components will be hot if the engine has been running. Allow the engine to cool before performing any engine maintenance. Always wear the appropriate PPE to prevent burns or exposure to engine oil.

For more specific information concerning your mower's engine, reference the included engine manual or go to the Owner's section of the Spartan website at: <https://spartanmowers.com/company/owner-info/>

The first oil change is required after the first 25 hours of operation. The control panel will show "CHG OIL" at 20 hours, and "CHG OIL NOW" at 25. Following the first oil change, perform an oil change every 100 hours of operation. Only use the recommended oil found in your mower's specific engine manual

Changing the Engine Oil:

1. Clean the area around oil fill cap. Remove the drain plug and the oil fill cap. Allow oil to drain completely into an approved container.

2. Clean the area around the oil filter and position a container underneath to catch any oil. Remove the filter. Wipe off the mounting area and reinstall the drain plug. Tighten to specific engine manual recommendation

3. Apply a thin film of clean oil to the new oil filter gasket and install. Refer to instructions on oil filter for proper installation.

4. Fill crankcase with new oil to the appropriate level and replace oil fill cap.

5. Start the engine and check for leaks. Stop the engine to correct any leaks and recheck the oil level.

6. Dispose of used oil and filter in accordance with local ordinances.

Air Cleaner Maintenance



CAUTION

DONOT run the engine with the air cleaner removed

Proper maintenance of the engine air cleaner is essential to engine performance and longevity. Be sure to reference your specific engine manual for proper servicing of your mower's air cleaner system.

Air cleaner maintenance intervals are found in the maintenance interval chart, however, the environment in which the mower is operated is the primary factor in determining when the air cleaner system must be serviced. For excessively dusty conditions the air cleaner may need to be serviced more often. Refer to your mower's specific engine manual for more information.

To Inspect the Air Cleaner System:

1. Unhook the clamps securing the air cleaner housing.
2. Remove the air cleaner and inspect.
3. Properly clean or replace the filter elements as recommended by your mower's specific engine manual.
4. Reassemble the air cleaner system and secure it with the clamps.

6.8 Belts

The following list details the appropriate belt for each location on the mower. It is recommended that you consult a Spartan dealer to ensure that the correct belt is used for replacement. Always use OEM parts offered through your authorized Spartan dealer.

Belt	Intimidator Part#
54" Deck Belt.....	461-0001-00
61" Deck Belt.....	461-0002-00
72" Deck Belt.....	461-0003-00
RZ 54/61"/RT Pump Belt (Non Tuff Torque).....	461-0004-00
SRT-PRO/SRT-HD Pump Belt.....	461-0005-00
SRT-XD Pump Belt.....	461-0006-00
48" Deck Belt.....	461-0009-00
Diesel Mower Pump Belt.....	461-0013-00
Diesel Mower 61" Deck Belt.....	461-0014-00
Tuff Torque Mower Pump Belt.....	461-0015-00
42" Deck Belt.....	461-0016-00
54" KG Deck Belt.....	461-0017-00
61" KG Deck Belt.....	461-0018-00
KG Drive Belt.....	461-0019-00
KGZ-XD Pump Belt.....	461-0020-00
61" KGZ-XD Deck Belt.....	461-0021-00

6.9 Mower Blade Maintenance



WARNING

Mower cutting blades are sharp and can cause severe injury. Always wrap the blades with heavy cloth and or wear heavy gloves while servicing them.

The key to a clean, professional cut is sharp mowing blades. Sharp blades will not only enhance the quality of the turf but allow the engine to function at maximum efficiency. Check your blades daily for sharpness and after each accidental contact with a heavy object.

Immediately replace any blade which is bent, cracked, or broken.

To remove:

Hold the blade in place and remove the 5/8" bolt at the bottom of the blade spindle. (15/16" wrench)

Sharpening:

Utilize a bench grinder, or angle grinder with a sturdy vise to sharpen your mower blades. Follow the existing bevel and only sharpen the blades from the top. DO NOT grind the blade down past 1/3 of its original depth. Always use Spartan OEM blades for maximum performance.



Figure 6.5: Mower Blade Edge

Balancing:

Before blades are re-installed on the mower, they must be properly balanced. Balancing tools can be found at most hardware supply stores and are the recommended method for balancing blades.

Alternatively, you can place the mower blade onto a vertical 5/8" bolt and observe any imbalance. Always correct imbalances before reinstalling the mower blades.

Replacing Mower Blades:

Before reinstalling each blade, lay it on a flat surface to ensure that it is flat. Any distorted blades must be replaced.

Do not reuse any hardware that is cracked, flattened, stripped, or excessively worn.

The curved section of the blade must point up and into the mower deck.

Torque mounting bolts to 115-120 ft-lbs.

Spin the blades manually before any mower operation to ensure that the blades will not hit each other or any other part of the deck.

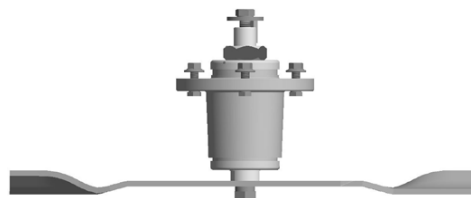

Figure 6.6: Mounted Mower Blade

6.10 Maintenance Schedule

Regular maintenance is crucial to the longevity of the service life of your Spartan mower. These intervals are recommendations for any equipment used under ideal conditions. If your machine is exposed to excessive moisture, dust, cold, or other stresses it is advised that you perform maintenance procedures more regularly than outlined below.

Before Each Use:

- General Inspection: Visually inspect unit for loose hardware and/or damaged parts.
- Check for battery connection/damage.
- Check blades
- Check engine oil and hydraulic pump oil
- Check fuel level
- Clean engine and transaxle compartment
- Check tire pressure with a gauge
- Clean engine exterior, paying special attention to the oil cooler and blower housing.
- Visually inspect ROPS and mounting hardware
- Clean grass off deck and muffler cover

Monthly:

- Grease deck height pivots
- Grease front wheel bearings
- Grease deck idler pulley
- Grease pump idler pulley
- Grease anti-scalp wheels
- Check pump & deck belt tension and condition

Every 100 Hours:

- Change engine oil and filter
- Tighten lug nuts on wheels

Every 200 Hours:

- Change Fuel Filter

7.0 Off-Season Storage



CAUTION

Failure to follow the instructions in this section can lead to poor engine performance and engine damage. Carefully read and follow all guidelines if your mower will be out of service for any extended period of time.

For more information refer to the included engine specific manual that came with your mower.

7.1 General Preparation

1. Clean the mower using mild soap and water. Remove all grass, dirt, and trash.
NOTE: DO NOT pressure wash the machine. Avoid washing the control panel and electronic components with excessive water.
2. Touch up any spots where paint has worn away and bare metal is exposed.
3. Check the mower for any components that need to be replaced and order them from your authorized Spartan dealer.
4. Thoroughly lubricate all components according to section 6.3 Lubrication.
5. Store the mower in a clean, dry place that is protected from the elements.

7.2 Engine Preparation

NOTE: For specific engine storage guidelines refer to your mower's engine manual. Proper storage is essential to your mower engine's performance and longevity.

1. Fuel becomes stale after 30 days and can damage parts of your engine. If you are not going to drain the fuel from your engine a fuel stabilizer must be used. Add the stabilizer according to instructions and run the engine for 2 minutes to circulate the stabilizer throughout the fuel system.
2. If no stabilizer is used, fuel must be drained into an approved container. Then run the engine until it stalls from lack of fuel.
3. Change the oil and oil filter while the engine is still warm.
4. Replace the fuel filter if it has not been replaced in the previous 200 hours.

5. Remove the spark plugs and pour a teaspoon of clean engine oil into each spark plug hole. Replace the spark plugs but do not reattach leads. Crank the engine with the starter several times to distribute oil throughout the cylinders.

6. Clean cylinders, fins, blower, housing, and muffler to remove dirt and chaff.

7. Wipe the exterior of the engine with a clean oily cloth.

8. Ensure that all caps are secure.

7.3 Battery Preparation

When the mower will not be used for extended periods, it is best to disconnect the battery and store it separately from the machine.



WARNING

Lead-acid batteries produce flammable and explosive gases. Provide proper ventilation and DO NOT expose the battery to any kind of flame, arc, or ember.

Battery posts, terminals, and related items contain lead which is known to cause cancer and reproductive harm. Wash hands after handling.

Electric storage battery fluid contains sulfuric acid which is poison and can cause SEVERE chemical burns. Avoid contact with battery fluid and do not tip any battery beyond 45 degrees.

1. Disconnect and remove the battery from the mower.
2. Clean the battery, connectors, and terminals of any debris or corrosion.
3. Charge the battery, if necessary.
4. Store the battery where it will not be exposed to extreme temperatures or water. A cool, dry place is ideal.
5. Always keep the battery fully charged, especially when the temperature is below freezing (32 degrees Fahrenheit).

7.4 New Season Preparation

Before starting the mower following storage, follow these service instructions to maintain mower efficiency and longevity.

1. Clean the mower, removing dirt and debris. Take special care to remove any debris from around the engine and muffler assembly (compressed air is recommended).
2. Ensure that engine oil and hydraulic fluid levels are correct.
3. Install fully charged battery and attach the battery cables.
4. Fill the fuel tank with fresh fuel. Start the engine and run the machine at half throttle for 5 minutes. Check steering control levers. Stop the engine and check for any loose fittings, leaks, or any other problems.
5. Check that all bolts are tight, and all pins are secure.
6. Install all safety shields. Review safety precautions.
7. Check and inflate tires to proper pressure.

8.0 Troubleshooting

TROUBLE	POSSIBLE CAUSE	SOLUTIONS
Engine will not crank	<ol style="list-style-type: none"> 1. Safety switches not depressed 2. Battery installed incorrectly 3. Battery is dead or weak 4. Blown fuse or circuit breaker 5. Engine ground wire loose 6. Starter solenoid malfunction 	<ol style="list-style-type: none"> 1. Check all four safety switches. 2. Remove battery and reinstall correctly. Consult a dealership if needed. 3. Recharge or replace battery. 4. Replace damaged part. 5. Tighten ground wire.
Engine cranks, but will not start or will not keep running	<ol style="list-style-type: none"> 1. Throttle or choke not in starting position 2. Dirty fuel cleaner 3. Fuel valve is off 4. Dirt, water, or stale fuel in the fuel system 	<ol style="list-style-type: none"> 1. Put throttle or choke into starting position and handles in neutral and press break. The console will indicate a problem. 2. Replace cleaner. 3. Open fuel valve. 4. Contact dealer.
Loss of power or system will not operate in either direction	<ol style="list-style-type: none"> 1. Restrictions in air cleaner 2. Tow valve open 3. Worn traction drive belt 4. Air in system 5. Internal interference, leakage in wheel motor, or poor 	<ol style="list-style-type: none"> 1. Service air cleaner. 2. Close tow valve. 3. Replace traction drive belt. 4. Check filter and fittings. 5. Contact dealer.
Mower will not discharge grass and/or cuts unevenly	<ol style="list-style-type: none"> 1. Engine speed low 2. Cutting height set too low 3. Blades short or dull 4. Underside of deck is dirty 5. Bad tire pressure 6. Blade is bent 	<ol style="list-style-type: none"> 1. Drive the machines faster. 2. Raise the cutting height setting. 3. Sharpen or replace blades. 4. Clean under the deck. 5. Adjust air pressure. 6. See dealer.
Low engine oil pressure	<ol style="list-style-type: none"> 1. Low oil level 2. Oil diluted or too light 3. Failed oil pump 	<ol style="list-style-type: none"> 1. Add oil. 2. Change oil and check for source of contamination. 3. Contact dealer.
Mower is jerky when starting or only operates in one direction	<ol style="list-style-type: none"> 1. Steering control linkage needs adjustment 2. Transaxle component faulty 3. Tow valves not completely closed 	<ol style="list-style-type: none"> 1. Adjust linkage. 2. Contact dealer. 3. Close tow valves. 4. Tighten linkage.

TROUBLE	POSSIBLE CAUSE	SOLUTIONS
Abnormal Vibration	<ol style="list-style-type: none"> 1. Engine mounting bolts are loose 2. Engine pulley, or blade pulley is loose 3. Engine pulley is damaged 4. Cutting blade is bent 5. A blade mounting bolt is loose 6. Spindle bearing is worn or loose 7. Spindle is bent 	<ol style="list-style-type: none"> 1. Tighten engine mounting bolts. 2. Tighten appropriate pulley. 3. Contact dealer. 4. Install new cutting blade. 5. Tighten mounting bolt. 6. Replace or tighten spindle bearing. 7. Contact dealer.
Blades Do Not Rotate	<ol style="list-style-type: none"> 1. Deck drive belt is worn, lose or broken 2. Deck drive belt is off the pulley 3. Electric clutch is not engaging 	<ol style="list-style-type: none"> 1. Install a new deck drive belt. 2. Install the deck drive belt and check for a reason. 3. Contact dealer.
Mower veers in one direction or creeps when in neutral or parked position	<ol style="list-style-type: none"> 1. Steering linkage needs adjustment 2. Loose steering linkage 3. Tires improperly inflated 4. Transaxle component faulty 5. Steering linkage out of adjustment 6. Brakes need adjustment 	<ol style="list-style-type: none"> 1. Adjust linkage. 2. Tighten linkage. 3. Adjust air pressure. 4. Contact dealer. 5. Adjust steering linkage. 6. Adjust parking brakes.

9.0 Error Codes

2.12 CONSOLE DIAGNOSTICS - When a fault is detected by the console it is displayed on the LCD as a numeric code. Below is a chart of the error codes and potential sources.

Note: Some maintenance must be performed by authorized Spartan technicians. Be sure to familiarize yourself with your mower's warranty.

ERROR CODE #	DESCRIPTION
10	Continuous PTO clutch current too high – check PTO clutch coil resistance.
11	Function inhibited because continuous system current too high.
12	Check battery condition and connections, check starter solenoid wiring for shorts.
13	Check battery condition and connections, check PTO and PTO wiring for shorts.
14	Check battery condition and connections, check fuel solenoid and fuel solenoid wiring for shorts.
15	Check headlight wiring for shorts.
16	Check battery condition and connections, check deck motor and wiring for shorts.
17	Check battery condition and connections.
18	Check battery condition and connections, check starter and fuel solenoid connections for shorts.
19	Check battery condition and connections, check PTO and PTO wiring for shorts.
20	Check battery connections, check fuel solenoid and wiring for shorts.
21	Check battery connections, check headlight wiring for shorts.
22	Check battery condition and connections, check deck motor and wiring for shorts.
23	Check battery condition and connections, check all wiring for shorts.
24	Excessive system current.
25	Check PTO current.
26	Excessive system current.
27	Excessive system current, check headlight.
28	Excessive system current, check for binding deck lift or problem with motor.
29	Excessive system current.
30	Console internal fault.
39	Console internal fault, some or all power functions inhibited.
40	Console internal fault.
41	Console internal fault.
42	Check PTO wiring.
43	Check PTO wiring.
44	Low PTO on current, check PTO wiring and connections.
45	Console internal fault.

10.0 Service Record

DATE	SERVICE	DATE	SERVICE

Operator Responsibility:

You are responsible for reading and fully understanding the content within this manual prior to operating your mower. Any accidents that occur are the responsibility of the owner.