

MattX™

CATALOGUE

Certified Comfort Mattress and Pillow



Change the way you sleep, for the better.

Certified Comfort for a Safe and Healthy Night's Rest

With our purity certifications, you can be assured to have a safe night sleep:

Say good-bye to chemical sinking foams and say hello to plush organic sleep for you and your family.

Pure Dreams, Pure Comfort

At MattX™, we prioritize your well-being by incorporating the latest in sleep technology while upholding the highest standards of purity. Our mattresses proudly carry certifications attesting to their chemical-free composition, ensuring you and your family can enjoy a safe and healthy night's sleep.

Sleeping on a MattX™ Mattress is not just about comfort; it's about making a conscious choice for a healthier lifestyle. Our commitment to eco-conscious practices extends beyond the mattress itself to our entire production process, ensuring minimal environmental impact.

Transform your nights with MattX™ Mattress – a perfect blend of certified purity, unmatched comfort, and conscious living. Elevate your sleep experience, embrace the night, and wake up refreshed with MattX™ Mattress – where your well-being is our top priority.

Elevate Your Rest with Certified Quality



All MattX™ Mattress Include



Table of Content

MattX™ Mattress and Pillow



MattX™ Hybrid Mattress ————— 05



MattX™ DUAL Mattress ————— 06,07



MattX™ Latex Pure Mattress ————— 08



MattX™ Mini Plus Hybrid Mattress — 09,10



MattX™ Mini Plus Ortho Mattress — 11,12

MattX™ Mini Topper ————— 13

MattX™ Memory Foam Pillow ————— 17

MattX™ Mini Coil Pillow ————— 15, 16

MattX™ Latex Pure Pillow ————— 18

MATTRESS

Certified Purity for Your Peaceful Nights





MattX™ Hybrid Mattress



Covered with TENCEL™ Knitted Cover



100% Natural



Organic Latex

Firmness: **7.5** Comfort

MattX™ Hybrid Mattress

MattX™ Hybrid Mattress not only supports pressure point relief and reducing pain, it could be coated with cooling gels to regulate heat. This is covered with TENCEL™ knitted fibre, is eco-friendly, 100% natural and is known to cool the skin with its efficient moisture wicking properties.



Dimensions

All dimensions are measured in centimeters (cm).

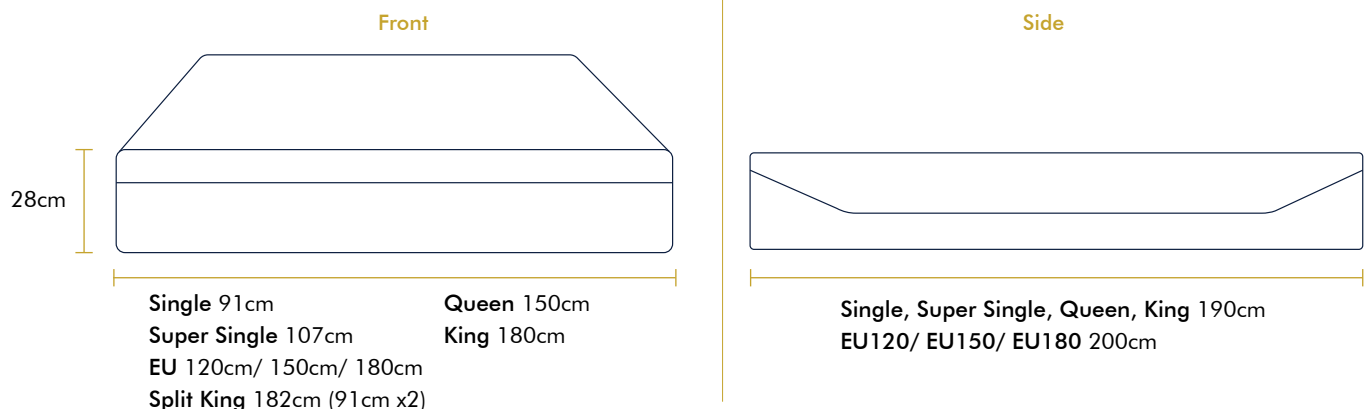

Mattress Layers

	Top Cover	Tencel Twin-Cool technology knitted cover
	1st Layer	2cm 100% natural latex which is certified by Eco-Institut
	2nd Layer	5cm Cool gel infused memory foam certified by CertiPUR-US
	3rd Layer	5cm Transition layers of responsive foam absorb movement
	4th Layer	16cm premium high-density support foam certified by CertiPUR-US
	Bottom	Anti-slip bottom non-woven fabrics with zip-off removable cover



MattX™ DUAL Mattress



Covered with Artic Cool Technology™
Super Cooling Zipper Cover



DUAL Firmness



TENCEL™
Knitted Zipper Cover

Firmness: **7~8.5**
Comfort

MattX™ DUAL Mattress

MattX™ DUAL is the 1st "Flippable" Mattress in Singapore. It combines 2 firmness in 1 mattress that features Artic Cool Technology™ zipper cover, which makes it stay cool at all times. Our unique design allows you to flip it to the side that feels best for you!

- **A soft mattress and a firm mattress in one**

Meet MattX™ Dual Mattress, a new mattress that understands you in both firmness and softness.

This flippable mattress that has a firmer latex layer on one side, flip it over and the other side is a softer memory foam so you get two mattress in one and two chances to find the right fit for you.



- **Universal comfort with cooling on contact**

Artic cool technology provides better cooling power for more comfortable and breathable sleep environment all night long.

Hear your cares melt away as you drift off to sleep!

Dimensions

All dimensions are measured in centimeters (cm).

Front

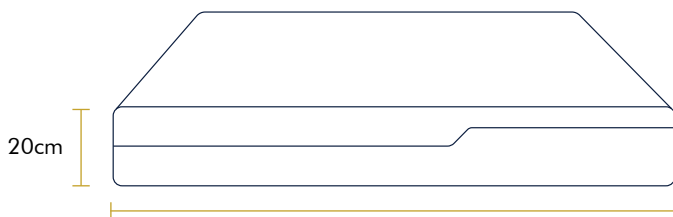

Single 91cm Queen 150cm
Super Single 107cm King 180cm
EU 120cm/ 150cm/ 180cm
Split King 182cm (91cm x2)

Side



Single, Super Single, Queen, King 190cm
EU120/ EU150/ EU180 200cm



MattX™ DUAL Mattress

Mattress Layers

	Top Cover	Artic Cool Technology™ super cooling zipper cover for easy swopping
	1st Layer	3cm thick 100% Natural Latex - Certified by Eco-Institut Germany GmbH (firmer surface can be top or bottom, simply flip it)
	2nd Layer	10cm thick High Density Support Core Foam Motion transfer control and foam used is certified by Certipur-US
	3rd Layer	4cm thick Max Flow Foam support allows breathable space for air movement, foam is certified by Certipur-US
	4th Layer	3cm thick Cool Gel Infused Memory Foam NASA invented foams that provide unrivalled comfort and pressure support, rapid cooling and body heat dissipation, foam used is certified by Certipur-US (Softer surface can be top or bottom, simply flip it)
	Bottom Cover	TENCEL™ knitted zipper cover for the more warmth yet breathable touch

The versatile MattX™ DUAL Mattress offers a flippable design, providing two distinct levels of firmness for a personalized sleep experience.





MattX™ Latex Pure Mattress



Covered with Artic Ultra Cool® Zipper Cover



100% Natural



Organic Latex

Firmness: **7/8/9**
Comfort

Thickness: **15 or 20 cm**

MattX™ Latex Pure Mattress

This engineered masterpiece is sure to give you the perfect night's rest, introducing exclusive advanced latex mattress technology that no other company can match.

Discover a truly customizable sleep experience tailored to your individual needs as you discover three distinct firmness levels: 7, 8 and 9 that let you dial in whatever level of support best fits your body and your personal preferences.



Feels so right

Dimensions

All dimensions are measured in centimeters (cm).

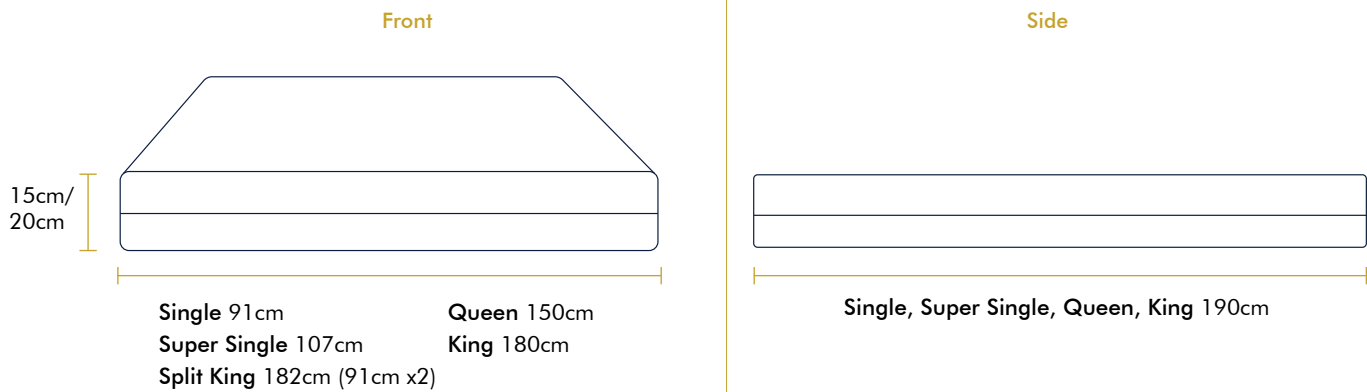

Mattress Layers

	Top Cover	Artic Ultra Cool® zipper cover for easy swapping
	Inner Cover	Woven fabric for durability, anti-bacteria & anti-mite
	Support Layers	Three/ Four Support Layers Each have 5cm plus layer of 100% Natural Latex, eco-INSTITUT® certified non toxic
	Bottom Cover	TENCEL™ knitted zipper cover for the more warmth yet breathable touch



MattX™ Mini Plus Hybrid Mattress



Covered with Artic Cool Technology™ Super Cooling Zipper Cover



DUAL Firmness



Bamboo Charcoal Memory Foam

Firmness: **8,9** Comfort



Mini Spring Coil

Best with Adjustable Bed Base

MattX™ Mini Plus Hybrid Mattress

Introducing the MattX™ Mini Plus Hybrid Mattress
A gateway to a whole new realm of sleep luxury. Revel in the sheer opulence of adjustable firmness, seamlessly gliding between two distinct levels — an inviting 8/10 and a sumptuous 9/10 on the firmness scale.

Our innovative design acknowledges that your needs change over time, offering an adaptable solution to match. And with the added benefit of a flippable mattress, every night becomes an exploration of personalized comfort. Elevate your sleep experience with a mattress that evolves with you.



Dimensions

All dimensions are measured in centimeters (cm).

Front

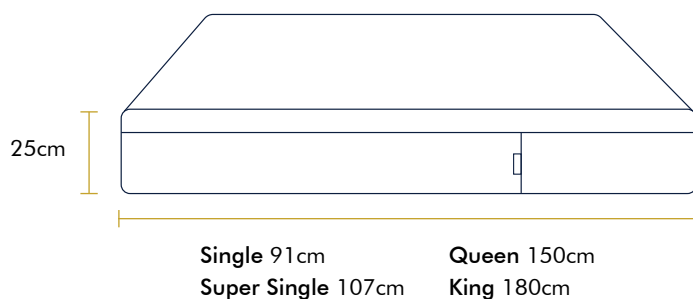

Side

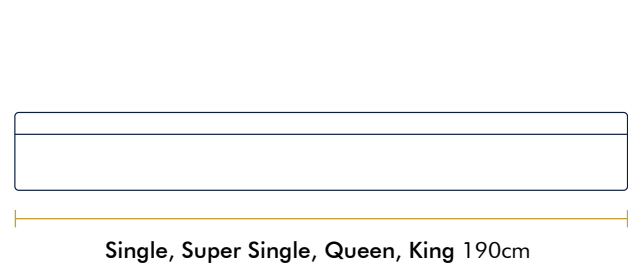



MattX™ Mini Plus Hybrid Mattress

Mattress Layers

	Top Cover	Artic Cool Technology™ - Super cooling zipper cover for easy swopping.
	2nd Layer	Waterproof cover - Flexible, durable, and stain-resistant, creating a protective layer. (Exchangable with Third Layer)
	3rd Layer	40mm Bamboo Charcoal Memory Foam 40D - Deodorant, anti-moisture and not easy to breeding bacteria. (Exchangable with Second Layer)
	4th Layer	40mm thick High Density Support Core Foam 35D - Motion transfer control and foam used is certified by Certipur-US.
	5th Layer	Non waterproof cover - Adds a touch of coziness to the mattress's foundation.
	6th Layer	Non-woven fabric - Supports the layers above and enhances overall durability.
	7th Layer	H100mm pocketed spring core - Offers customised comfort and undisturbed sleep by individually responding to your body's needs.
	8th Layer	Non-woven fabric - Provides the ultimate base of support and stability.
	9th Layer	7mm Polyurethane (PU) Foam - Adds the final touch of elegance, cocooning you in comfort.
	Bottom Cover	Woven fabric - Anti-slip with zip-off removable cover

The versatile MattX™ Mini Plus Hybrid Mattress offers a flippable design, providing two distinct levels of firmness for a personalized sleep experience.



MattX™ Mini Plus Ortho Mattress



Covered with Artic Ultra Cool® Zipper Cover



100% Natural



Organic Latex



Optimal Spinal Alignment

Firmness: **9.5** Comfort



Mini Spring Coil

Best with Adjustable Bed Base



MattX™ Mini Plus Ortho Mattress

Where Comfort Meets Orthopedic Excellence

Experience the perfect union of adaptive comfort and orthopedic excellence with the groundbreaking MattX™ Mini Plus Ortho Mattress. This mattress transcends conventional sleep boundaries, merging responsive support with luxurious comfort to cater to your body's unique requirements.

Chiropractor and Physiotherapist Recommended

Crafted with ergonomic design principles, it aims to potentially alleviate back pain symptoms. Rest easy knowing that experts in the field recognize its potential to enhance your well-being. Your journey to a more comfortable, rejuvenating sleep experience begins here.

A Haven of Cleanliness

Rest assured as you rest. Our mattress boasts anti-bacterial and mite-proof properties that act as a barrier against unwelcome microbes. This defense extends to resist mold, mildew, dust mites, and other allergens, ensuring a sleep environment that's both hygienic and inviting.

Dimensions

All dimensions are measured in centimeters (cm).

Front

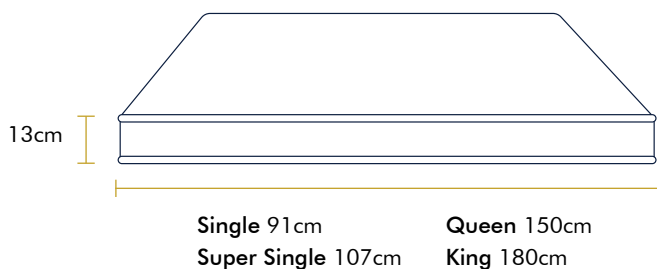

Side

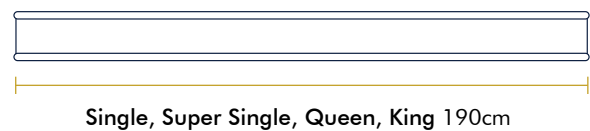



MattX™ Mini Plus Ortho Mattress

Mattress Layers

	Top Cover	Infused with Artic Cool Technology™ Knitted Fabric ensures consistent airflow and breathability.
	2nd Layer	Organic cotton provides a tailored support system for optimum comfort.
	3rd Layer	25mm Polyurethane (PU) Foam with a density of 40D eases pressure points for a relaxing sleep experience.
	4th Layer	Non-woven fabric adds durability and stability to the mattress's structure.
	5th Layer	Crafted from Felt enhances the overall mattress structure.
	6th Layer	The H100mm pocketed spring core offers customised comfort and undisturbed sleep by individually responding to your body's needs.
	7th Layer	Crafted from Felt adds a finishing touch of comfort.
	Bottom Cover	Non-woven fabric completes the mattress's structure with a touch of excellence.





MattX™ Mini Topper

DUAL Fabric Design



Covered with Artic Cool Technology™ Knitted Cover

DUAL Fabric Design



Covered with TENCEL™ Knitted Cover



Removable Cover Easy Clean



Micro Spring Technology™

Best with Adjustable Bed Base

MattX™ Mini Topper

Elevate Your Rest, Enter a World of Unrivaled Comfort
 Introducing the MattX™ Mini Topper – a fusion of innovation and comfort that harmonizes seamlessly. Elevate your sleep with this micro spring topper, meticulously engineered to redefine your mattress's comfort and support. Immerse yourself in a crafted masterpiece that transforms your sleep sanctuary into an oasis of relaxation and tranquility.



Naturally Hypoallergenic



Mite-Resistant



Antibacterial



Premium Cooling Comfort

Dimensions

All dimensions are measured in centimeters (cm).

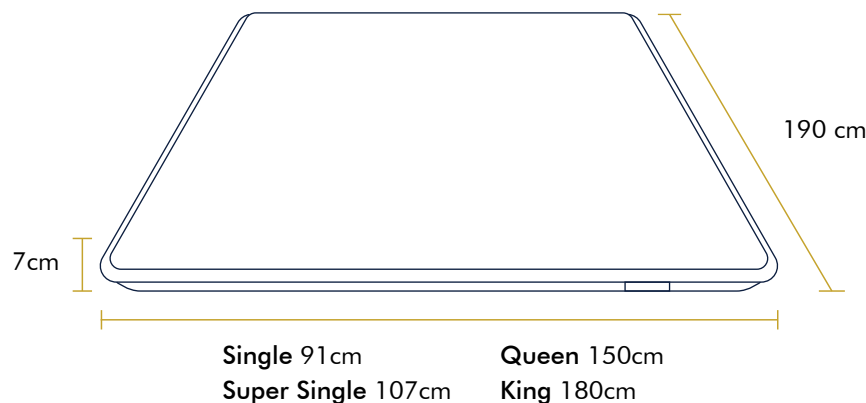

PILLOW

Dive into Comfort with Our Pillows



MattX™ Mini Coil Pillow



Artic Cool Technology™



Micro Spring Technology™



Dual-Sided Comfort



Antibacterial



Mite-Resistant



Dual-Sided Comfort

Experience the epitome of comfort with our Pillow featuring both **Memory Foam** and **Micro Spring Technology™**. Uncover the key to your best sleep as you immerse yourself in the revitalizing touch of our cutting-edge cooling gel.

Unveiling the Future of Comfort

Experience the epitome of comfort with our Pillow featuring both **Memory Foam** and **Micro Spring Technology™**. Uncover the key to your best sleep as you immerse yourself in the revitalizing touch of our cutting-edge cooling gel. Crafted to perfection, this low-loft pillow is meticulously designed to cater seamlessly to the preferences of stomach and back sleepers.



Crafted to perfection, this low-loft pillow is meticulously designed to cater seamlessly to the preferences of stomach and back sleepers.



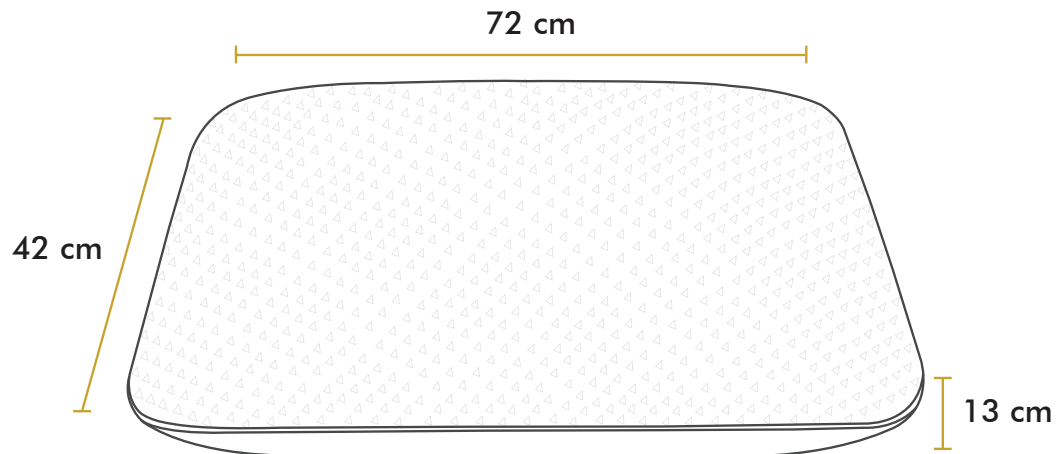

MattX™ Mini Coil Pillow

Dimensions

All dimensions are measured in centimeters (cm).



Pillow Layers

	Top Cover	Crafted from TENCEL™ knitted fabric, ensuring a soft, breathable, and environmentally-friendly surface.
	2nd Layer	50mm thick Cool Gel Infused Memory Foam - NASA invented foams that provide unrivalled comfort and pressure support, rapid cooling and body heat dissipation, foam used is certified by Certipur-US.
	3rd Layer	Every Micro Spring, meticulously designed with 1.6mm wire diameter and 30mm height, conforms to your body's unique contours.
	4th Layer	50mm Memory Foam adding an extra touch of plushness and coziness to your slumber.
	Bottom Cover	TENCEL™ knitted cover for the more warmth yet breathable touch.



MattX™ Memory Foam Pillow



 TENCEL™ Knitted Cover

 Hypo-allergenic Bliss

 Perfect Dimensions

 Memory Foam Comfort



Awaken Refreshed, Sleep Reimagined

Introducing the MattX™ Memory Foam Pillow, a harmonious blend of cutting-edge memory foam technology, natural ingredients, and hypo-allergenic excellence, creating a haven of comfort and health-conscious luxury for your sleep.



Hypo-allergenic Bliss

Say goodbye to allergy concerns. The MattX Memory Foam Pillow is hypo-allergenic, making it the perfect choice for allergy sufferers seeking a clean and healthy sleep environment.



Perfect Dimensions

This pillow strikes the ideal balance between support and comfort. It's not too high, not too low - just perfect for a rejuvenating sleep experience.



Memory Foam Comfort

Experience a new level of comfort with our premium memory foam core that contours to the shape of your head and neck, providing natural support for a restful night's sleep.

Dimensions

All dimensions are measured in centimeters (cm).

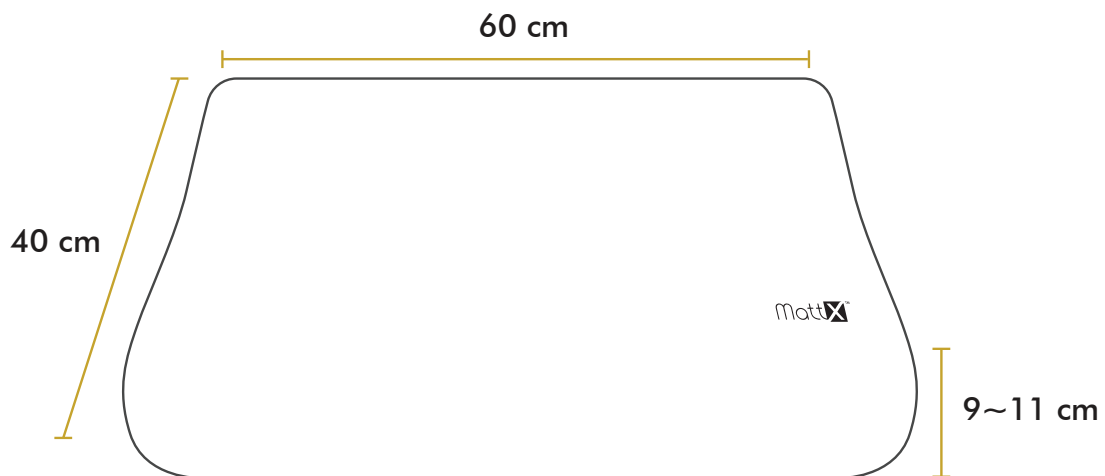

MattX™ Latex Pure Pillow



Covered with Artic Ultra Cool®
Zipper Cover



100% Natural



Organic Latex



Feels so right

TENCEL™ Removable Cover



No Synthetic Materials

MattX™ Latex Pure Pillow

Sleep with Nature, Sleep with Comfort

Introducing the MattX™ Latex Pure Pillow – your perfect partner for restful, uninterrupted slumber! The pillow is made of 100% natural latex, which provides excellent support and comfort for your head, neck, and shoulders. The latex material is also naturally hypoallergenic and resistant to dust mites, making it a great option for people with allergies or respiratory issues.

The Artic Ultra Cool© and TENCEL™ fabric removable cover is designed to keep you cool and comfortable throughout the night. It features advanced cooling technology that wicks away moisture and heat from your body, ensuring that you stay comfortable and dry while you sleep. This feature is especially helpful for those who tend to sleep hot or experience night sweats.



Dimensions

All dimensions are measured in centimeters (cm).

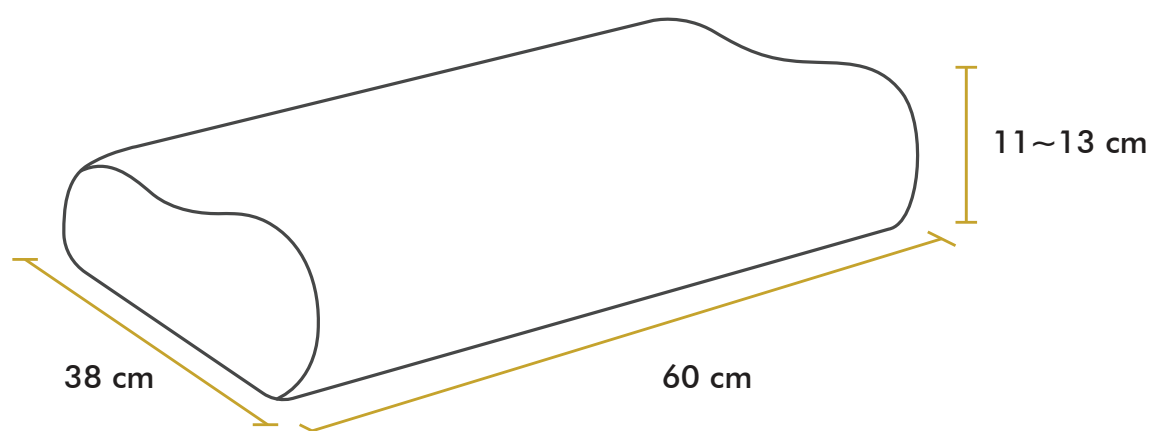



Contact Us _____

AFFAIRS™
SMART FURNISHING

Affairs Living Singapore

Affairs Living Pte. Ltd.
Gemini@Sims HQ (Showroom)
2 Sims Close #01-13
Gemini @ Sims Singapore 387298
(8 mins walk from Aljunied MRT)

Email: askme@affairs.sg
Whatsapp: +65-96535877

BEDDING AFFAIRS™
Trends. Comfort. Moods.

Bedding Affairs Malaysia

Bedding Affairs Sdn. Bhd. (1325629H)
No.1, Block C, Jalan Dataran SD1,
Bandar Sri Damansara, Ground Floor,
52200 Kuala Lumpur
(Next to Sri Damansara LRT)
Free Parking Daily on refund basis

Email: askme@beddingaffairs.com
Whatsapp: +6011-58903014
Office: +60362632890

 **ALYA SMART HOME**
上海艾利亚科技贸易有限公司

Shanghai, China

ALYA SMART HOME TRADE CO. LTD.
S300-301, 3F,
No.8 Changxiang Rd,
Nanxiang Town, Jia Ding Shanghai,
China 201802