

ENDLESS NIGHTS OF COMFORT

Bundle Deals

Adjustable Bed Base and Mattress



2 in 1 Bundle Adjustable Bed Base and Mattress

Enjoy value pricing and 0% APR instalment options on any adjustable bed base and mattress combo.

Elevate Your Rest with Certified Quality



Bundle up for better sleep

2 in 1 | Adjustable Bed Base and Mattress

Bundle Item 1

Select an Adjustable Bed Base

ALYA Sleepthetic

ALYA™ Adjustable Bed Base

Page

04

ALYA™ Adjustable Bed Base Version S

05

ALYA™ Adjustable Bed Base Version X

06

Sleepthetic™ Adjustable Bed Base

07

1 of 2

Bundle Item 2

Select a Mattress

MattX™ ANSSil Emma®

MattX™ Hybrid Mattress

10

ANSSil Smart Line Mattress

19

MattX™ Dual Mattress

11-12

ANSSil Premium Hybrid Line Mattress

20-21

MattX™ Latex Pure Mattress

13

Emma Diamond Hybrid Mattress

22

MattX™ Mini Plus Hybrid Mattress

14-15

Emma Original Hybrid Mattress

23

MattX™ Mini Plus Ortho Mattress

16-17

2 of 2

ALYA Sleepthetic

Adjustable Bed Base

Indulge in Precision Comfort



Adjust to Perfection



Improved Sleep Quality



Back Pain Relief



Enhanced Circulation



Reduced Acid Reflux



Snoring Reduction



Joint Support



Customized Support



Enhanced Relaxation

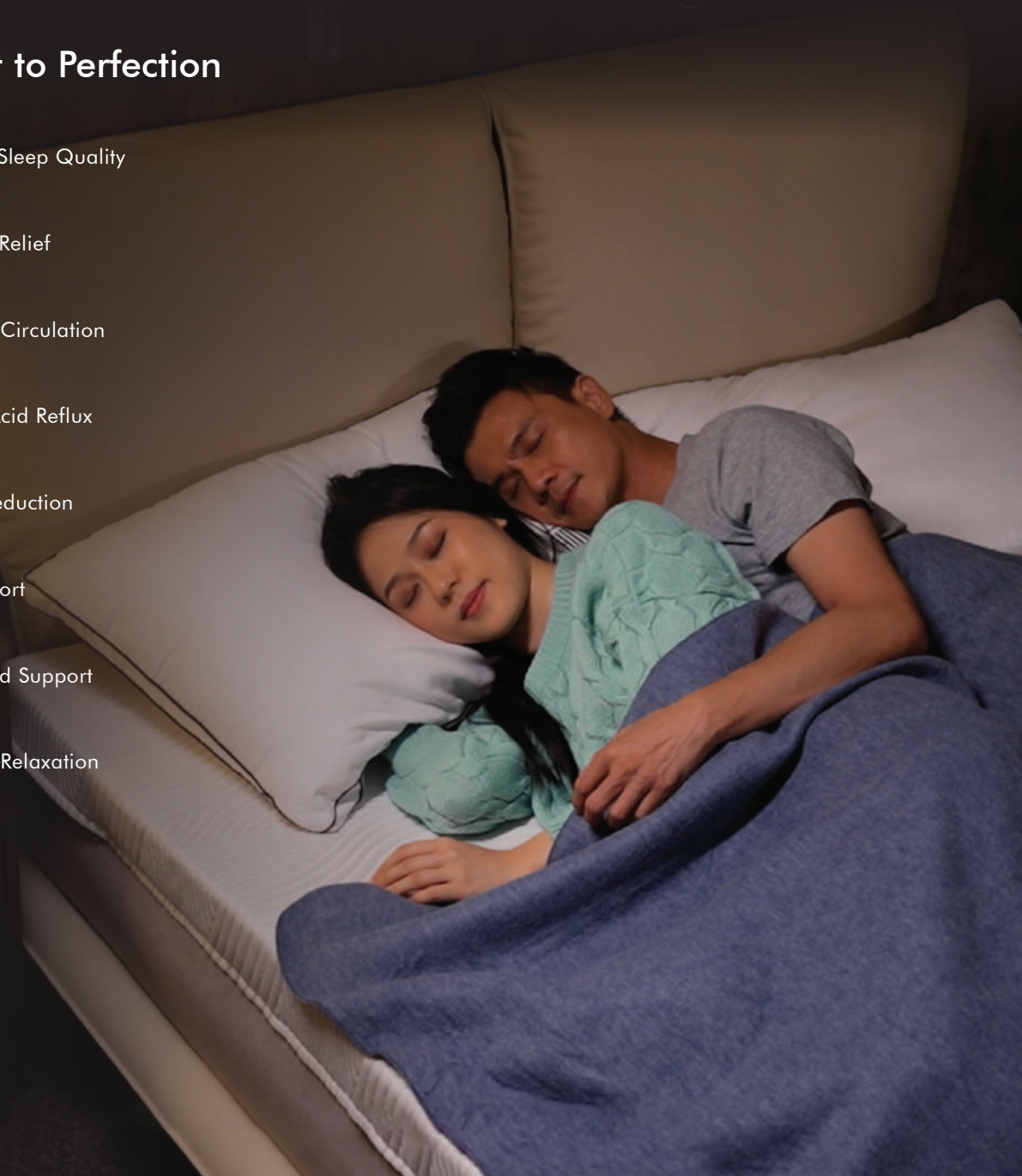

APP Control



AI APP Control | AI Smart Alarm | Remote Controller



ALYA™ Adjustable Bed Base



Specifications

- AI Controlled wake up call
- Adjust foot position from 0-35 degrees
- Elevate your head angle from 0-80 degrees
- DUAL Massage
- USD Ports
- Able to lay flat
- Anti-Slide Deck
- Silent and Durability
- Underbed LED Lights
- Hold up to 250kg (Inclusive of mattress)

Size

Split King | King | Queen | Super Single | Single | EU 180x200 | EU 150x200 | EU 120x200

Set Content

1x ALYA™ Adjustable Bed Base

Dimensions

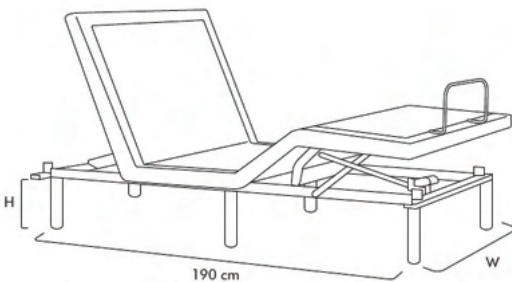

ALYA™ Adjustable Bed Base

	Split King (2x Single)	King	Queen	Super Single	Single
Carton Size	(97 x 101 x 22) x 2	181 x 101 x 22	156 x 101 x 22	113 x 101 x 22	97 x 101 x 22
Product Dimension	182 x 190 cm	181 x 190 cm	150 x 190 cm	107 x 190 cm	91 x 190 cm
Total Weight	90 kg	80 kg	62.5 kg	50 kg	45 kg
Adjustable Legs	Floor to top from 7 to 39 cm tall				

All dimensions are measured by centimeters (cm).

APP Control



AI APP Control | AI Smart Alarm | Remote Controller



ALYA™ Adjustable Bed Base Version S



Specifications

- AI Controlled wake up call
- Head Tilt
- Lumbar Support
- Adjust foot position from 0-35 degrees
- Elevate your head angle from 0-80 degrees
- USB Ports
- Anti-Slide Deck
- Able to lay flat
- DUAL Massage
- Silent and Durability
- Underbed LED Lights
- Hold up to 250kg (Inclusive of mattress)

Size

Split King | King | Queen | Super Single | Single

Set Content

1x ALYA™ Adjustable Bed Base Version S

Dimensions

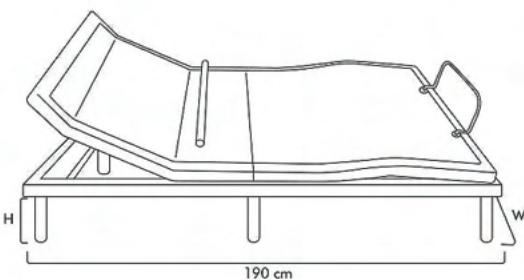

All dimensions are measured in centimeters (cm).

ALYA™ Adjustable Bed Base Version S

	Split King (2x Single)	King	Queen	Super Single	Single
Carton Size	(96 x 100 x 25.5) x 2	185 x 190 x 25.5	155 x 100 x 25.5	112 x 100 x 25.5	96 x 100 x 25.5
Product Dimension	(91 x 190 cm) x 2	180 x 190 cm	150 x 190 cm	107 x 190 cm	91 x 190 cm
Total Weight† (Included Packaging)	(52 kg) x 2	94 kg	68 kg	57 kg	52 kg
Net Weight (Without Packaging)	(49kg) x 2	88 kg	64 kg	54 kg	49 kg
Adjustable Legs	Floor to top from 7 to 39 cm tall		Lay Flat Thickness		10 cm

APP Control



AI APP Control | AI Smart Alarm | Remote Controller



ALYA™ Adjustable Bed Base Version X



Specifications

- AI Controlled wake up call
- Head Tilt
- Lumbar Support
- Adjust foot position from 0-35 degrees
- Elevate your head angle from 0-80 degrees
- USD Ports
- Anti-Slide Deck
- Able to lay flat
- DUAL Massage
- Silent and Durability
- Underbed LED Lights
- Hold up to 250kg (Inclusive of mattress)

Size

Split King | Queen | Super Single | Single | EU 180x200 | EU 150x200 | EU 120x200

Set Content

1x ALYA™ Adjustable Bed Base Version X

Dimensions

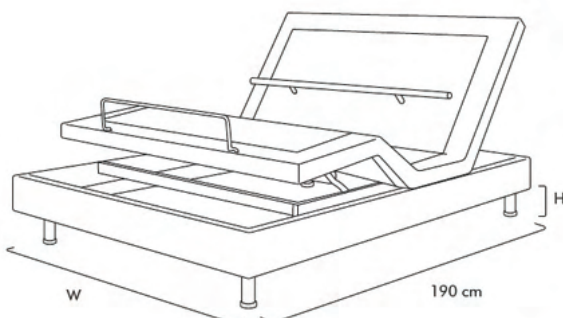

ALYA™ Adjustable Bed Base Version X

	Split King (2x Single)	Queen	Super Single	Single
Carton Size	(200 x 102 x 22) x 2	200 x 159 x 22	200 x 118 x 22	200 x 102 x 22
Product Dimension	183 x 190 cm	150 x 190 cm	107 x 190 cm	91 x 190 cm
Total Weight	156 kg	100 kg	85 kg	78 kg
Net Weight	140 kg	87 kg	80 kg	70 kg
Adjustable Legs	Floor to top from 18 to 40 cm tall			

All dimensions are measured by centimeters (cm).



Remote Controller



Sleepthetic™ Adjustable Bed Base 1.0

Specifications

- Adjust foot position from 0-35 degrees
- Elevate your head angle from 0-80 degrees
- Able to lay flat
- Anti-Slide Deck
- Silent and Durability
- OKIN German-engineered motor
- Hold up to 250kg (Inclusive of mattress)

Size

Split King | Queen | Super Single | Single | EU 180x200 | EU 150x200 | EU 120x200

Set Content

1x Sleepthetic™ Adjustable Bed Base

Dimensions

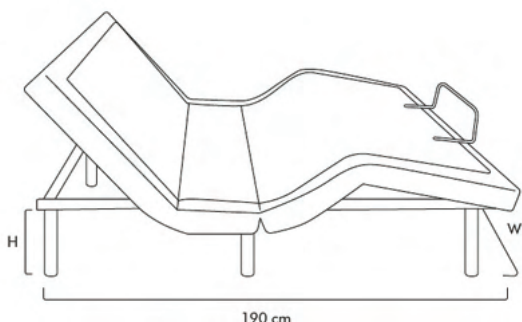

All dimensions are measured by centimeters (cm).

Sleepthetic™ Adjustable Bed Base

	Split King (2x Single)	King	Queen	Super Single	Single
Carton Size	(97 x 101 x 22) x 2	181 x 101 x 22	156 x 101 x 22	113 x 101 x 22	97 x 101 x 22
Product Dimension	182 x 190 cm	181 x 190 cm	150 x 190 cm	107 x 190 cm	91 x 190 cm
Total Weight	90 kg	88 kg	62 kg	48.8 kg	43.8 kg
Adjustable Legs	Floor to top from 7 to 39 cm tall				

MattX™ ANSSil Emma®

Mattress

Sleep Solutions for Every Preference
from Smart to Natural, We Have It All



Certified Comfort for a Safe and Healthy Night's Rest

With our purity certifications, you can be assured to have a safe night sleep:

Say good-bye to chemical sinking foams and say hello to plush organic sleep for you and your family.

Pure Dreams, Pure Comfort

At MattX™, we prioritize your well-being by incorporating the latest in sleep technology while upholding the highest standards of purity. Our mattresses proudly carry certifications attesting to their chemical-free composition, ensuring you and your family can enjoy a safe and healthy night's sleep.

Sleeping on a MattX™ Mattress is not just about comfort; it's about making a conscious choice for a healthier lifestyle. Our commitment to eco-conscious practices extends beyond the mattress itself to our entire production process, ensuring minimal environmental impact.

Transform your nights with MattX™ Mattress – a perfect blend of certified purity, unmatched comfort, and conscious living. Elevate your sleep experience, embrace the night, and wake up refreshed with MattX™ Mattress – where your well-being is our top priority.

Elevate Your Rest with Certified Quality



All MattX™ Mattress Include





MattX™ Hybrid Mattress



Covered with TENCEL™ Knitted Cover



100% Natural



Organic Latex

Firmness: **7.5** Comfort

MattX™ Hybrid Mattress

MattX™ Hybrid Mattress not only supports pressure point relief and reducing pain, it could be coated with cooling gels to regulate heat. This is covered with TENCEL™ knitted fibre, is eco-friendly, 100% natural and is known to cool the skin with its efficient moisture wicking properties.

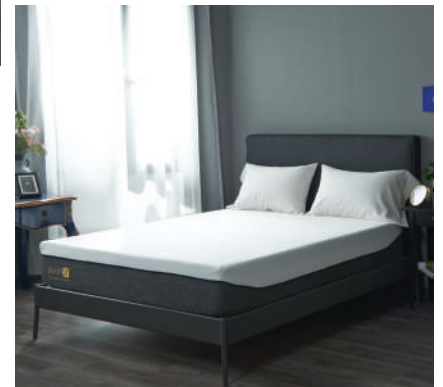

Dimensions

All dimensions are measured in centimeters (cm).

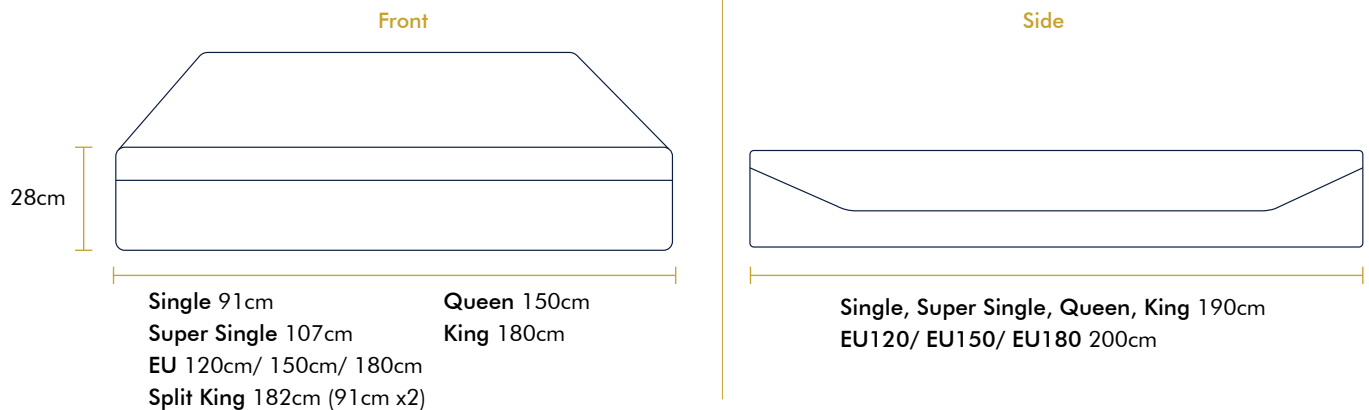

Mattress Layers

	Top Cover	Tencel Twin-Cool technology knitted cover
	1st Layer	2cm 100% natural latex which is certified by Eco-Institut
	2nd Layer	5cm Cool gel infused memory foam certified by CertiPUR-US
	3rd Layer	5cm Transition layers of responsive foam absorb movement
	4th Layer	16cm premium high-density support foam certified by CertiPUR-US
	Bottom	Anti-slip bottom non-woven fabrics with zip-off removable cover



MattX™ DUAL Mattress



Covered with Artic Cool Technology™
Super Cooling Zipper Cover



DUAL Firmness



TENCEL™
Knitted Zipper Cover

Firmness: **7~8.5**
Comfort

MattX™ DUAL Mattress

MattX™ DUAL is the 1st "Flippable" Mattress in Singapore. It combines 2 firmness in 1 mattress that features Artic Cool Technology™ zipper cover, which makes it stay cool at all times. Our unique design allows you to flip it to the side that feels best for you!

◦ A soft mattress and a firm mattress in one

Meet MattX™ Dual Mattress, a new mattress that understands you in both firmness and softness.

This flippable mattress that has a firmer latex layer on one side, flip it over and the other side is a softer memory foam so you get two mattress in one and two chances to find the right fit for you.



◦ Universal comfort with cooling on contact

Artic cool technology provides better cooling power for more comfortable and breathable sleep environment all night long.

Hear your cares melt away as you drift off to sleep!

Dimensions

All dimensions are measured in centimeters (cm).

Front

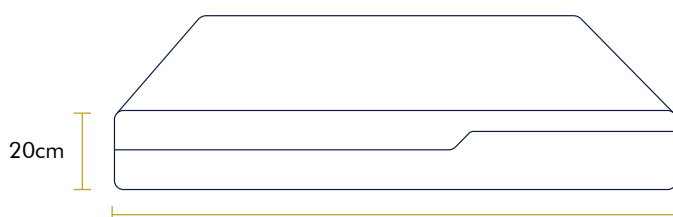

Single 91cm Queen 150cm
Super Single 107cm King 180cm
EU 120cm/ 150cm/ 180cm
Split King 182cm (91cm x2)

Side



Single, Super Single, Queen, King 190cm
EU120/ EU150/ EU180 200cm



MattX™ DUAL Mattress

Mattress Layers

	Top Cover	<p>Artic Cool Technology™ super cooling zipper cover for easy swapping</p>
	1st Layer	<p>3cm thick 100% Natural Latex - Certified by Eco-Institut Germany GmbH (firmer surface can be top or bottom, simply flip it)</p>
	2nd Layer	<p>10cm thick High Density Support Core Foam Motion transfer control and foam used is certified by Certipur-US</p>
	3rd Layer	<p>4cm thick Max Flow Foam support allows breathable space for air movement, foam is certified by Certipur-US</p>
	4th Layer	<p>3cm thick Cool Gel Infused Memory Foam NASA invented foams that provide unrivalled comfort and pressure support, rapid cooling and body heat dissipation, foam used is certified by Certipur-US (Softer surface can be top or bottom, simply flip it)</p>
	Bottom Cover	<p>TENCEL™ knitted zipper cover for the more warmth yet breathable touch</p>

The versatile MattX™ DUAL Mattress offers a flippable design, providing two distinct levels of firmness for a personalized sleep experience.





MattX™ Latex Pure Mattress



Covered with Artic Ultra Cool®
Zipper Cover



100% Natural



Organic Latex

Firmness:

7/8/9
Comfort

Thickness:

15 or 20 cm

MattX™ Latex Pure Mattress

This engineered masterpiece is sure to give you the perfect night's rest, introducing exclusive advanced latex mattress technology that no other company can match.

Discover a truly customizable sleep experience tailored to your individual needs as you discover three distinct firmness levels: 7, 8 and 9 that let you dial in whatever level of support best fits your body and your personal preferences.



Dimensions

All dimensions are measured in centimeters (cm).

Front



Single 91cm **Queen** 150cm
Super Single 107cm **King** 180cm
Split King 182cm (91cm x2)

Side

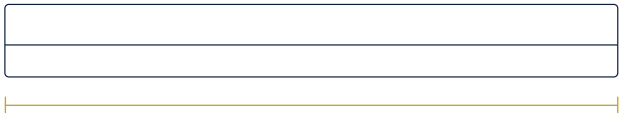

Single, Super Single, Queen, King 190cm

Mattress Layers

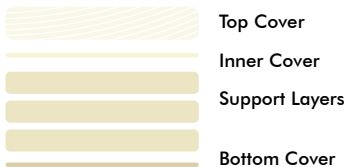

Top Cover Artic Ultra Cool® zipper cover for easy swapping
Inner Cover Woven fabric for durability, anti-bacteria & anti-mite
Support Layers Three/ Four Support Layers
 Each have 5cm plus layer of 100% Natural Latex, eco-INSTITUT® certified non toxic
Bottom Cover TENCEL™ knitted zipper cover for the more warmth yet breathable touch



MattX™ Mini Plus Hybrid Mattress



Covered with Artic Cool Technology™ Super Cooling Zipper Cover



DUAL Firmness



Bamboo Charcoal Memory Foam

Firmness: **8,9** Comfort



Mini Spring Coil

Best with Adjustable Bed Base

MattX™ Mini Plus Hybrid Mattress

Introducing the MattX™ Mini Plus Hybrid Mattress
 A gateway to a whole new realm of sleep luxury. Revel in the sheer opulence of adjustable firmness, seamlessly gliding between two distinct levels — an inviting 8/10 and a sumptuous 9/10 on the firmness scale.

Our innovative design acknowledges that your needs change over time, offering an adaptable solution to match. And with the added benefit of a flippable mattress, every night becomes an exploration of personalized comfort. Elevate your sleep experience with a mattress that evolves with you.



Dimensions

All dimensions are measured in centimeters (cm).

Front

Side

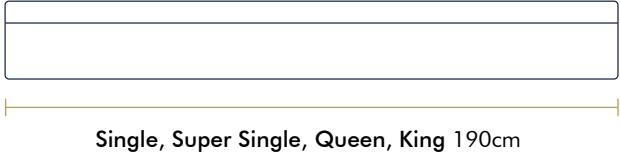
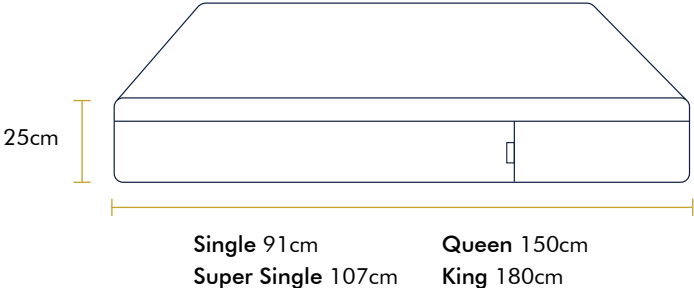



MattX™ Mini Plus Hybrid Mattress

Mattress Layers

	Top Cover	Artic Cool Technology™ - Super cooling zipper cover for easy swapping.
	2nd Layer	Waterproof cover - Flexible, durable, and stain-resistant, creating a protective layer. (Exchangable with Third Layer)
	3rd Layer	40mm Bamboo Charcoal Memory Foam 40D - Deodorant, anti-moisture and not easy to breeding bacteria. (Exchangable with Second Layer)
	4th Layer	40mm thick High Density Support Core Foam 35D - Motion transfer control and foam used is certified by Certipur-US.
	5th Layer	Non waterproof cover - Adds a touch of coziness to the mattress's foundation.
	6th Layer	Non-woven fabric - Supports the layers above and enhances overall durability.
	7th Layer	H100mm pocketed spring core - Offers customised comfort and undisturbed sleep by individually responding to your body's needs.
	8th Layer	Non-woven fabric - Provides the ultimate base of support and stability.
	9th Layer	7mm Polyurethane (PU) Foam - Adds the final touch of elegance, cocooning you in comfort.
	Bottom Cover	Woven fabric - Anti-slip with zip-off removable cover

The versatile MattX™ Mini Plus Hybrid Mattress offers a flippable design, providing two distinct levels of firmness for a personalized sleep experience.



MattX™ Mini Plus Ortho Mattress



Covered with Artic Ultra Cool® Zipper Cover



100% Natural



Organic Latex



Optimal Spinal Alignment

Firmness: **9.5** Comfort



Mini Spring Coil

Best with Adjustable Bed Base

MattX™ Mini Plus Ortho Mattress

Where Comfort Meets Orthopedic Excellence

Experience the perfect union of adaptive comfort and orthopedic excellence with the groundbreaking MattX™ Mini Plus Ortho Mattress. This mattress transcends conventional sleep boundaries, merging responsive support with luxurious comfort to cater to your body's unique requirements.

Chiropractor and Physiotherapist Recommended

Crafted with ergonomic design principles, it aims to potentially alleviate back pain symptoms. Rest easy knowing that experts in the field recognize its potential to enhance your well-being. Your journey to a more comfortable, rejuvenating sleep experience begins here.



A Haven of Cleanliness

Rest assured as you rest. Our mattress boasts anti-bacterial and mite-proof properties that act as a barrier against unwelcome microbes. This defense extends to resist mold, mildew, dust mites, and other allergens, ensuring a sleep environment that's both hygienic and inviting.

Dimensions



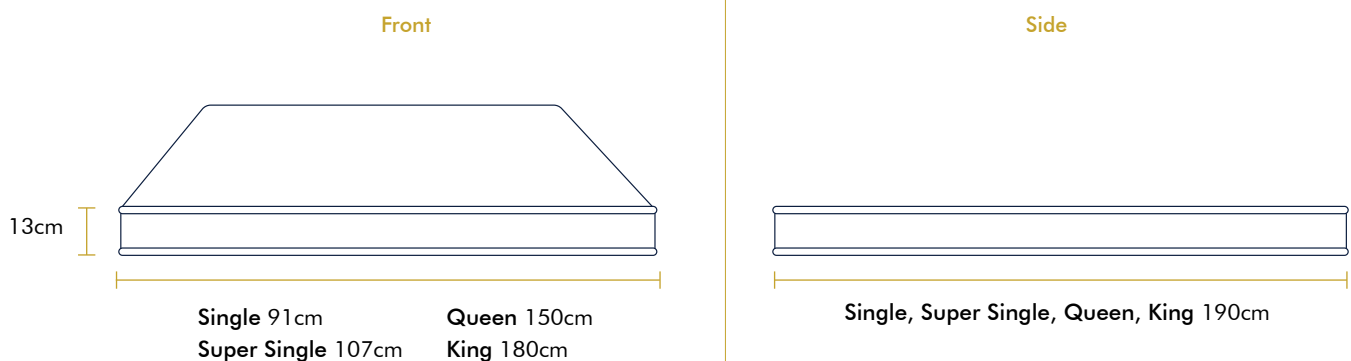





All dimensions are measured in centimeters (cm).





MattX™ Mini Plus Ortho Mattress

Mattress Layers

	Top Cover	Infused with Artic Cool Technology™ Knitted Fabric ensures consistent airflow and breathability.
	2nd Layer	Organic cotton provides a tailored support system for optimum comfort.
	3rd Layer	25mm Polyurethane (PU) Foam with a density of 40D eases pressure points for a relaxing sleep experience.
	4th Layer	Non-woven fabric adds durability and stability to the mattress's structure.
	5th Layer	Crafted from Felt enhances the overall mattress structure.
	6th Layer	The H100mm pocketed spring core offers customised comfort and undisturbed sleep by individually responding to your body's needs.
	7th Layer	Crafted from Felt adds a finishing touch of comfort.
	Bottom Cover	Non-woven fabric completes the mattress's structure with a touch of excellence.



ANSSII



Eco-friendly



No waste, 100% Recyclable



Low carbon

ALL NEW
SLEEP

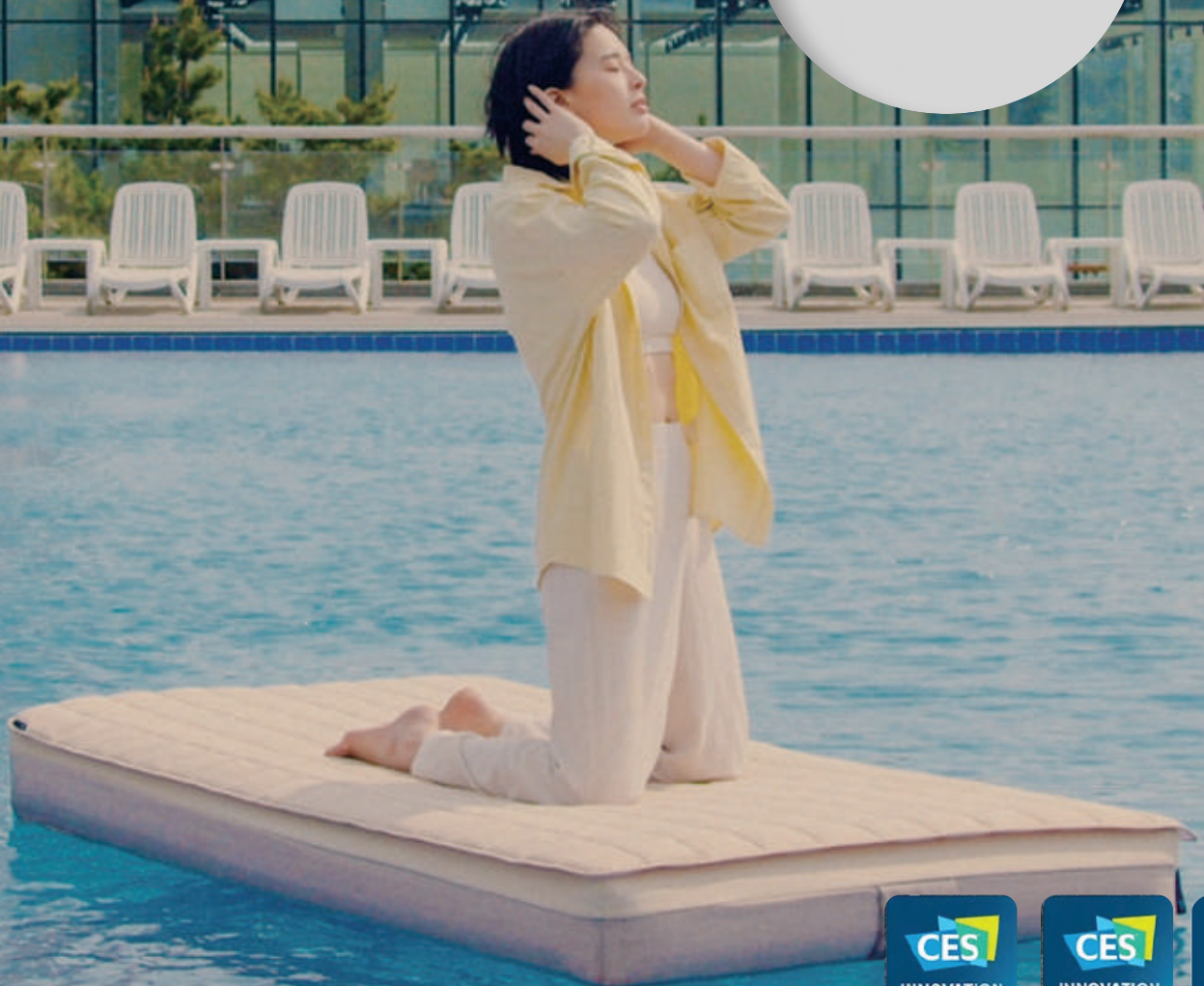

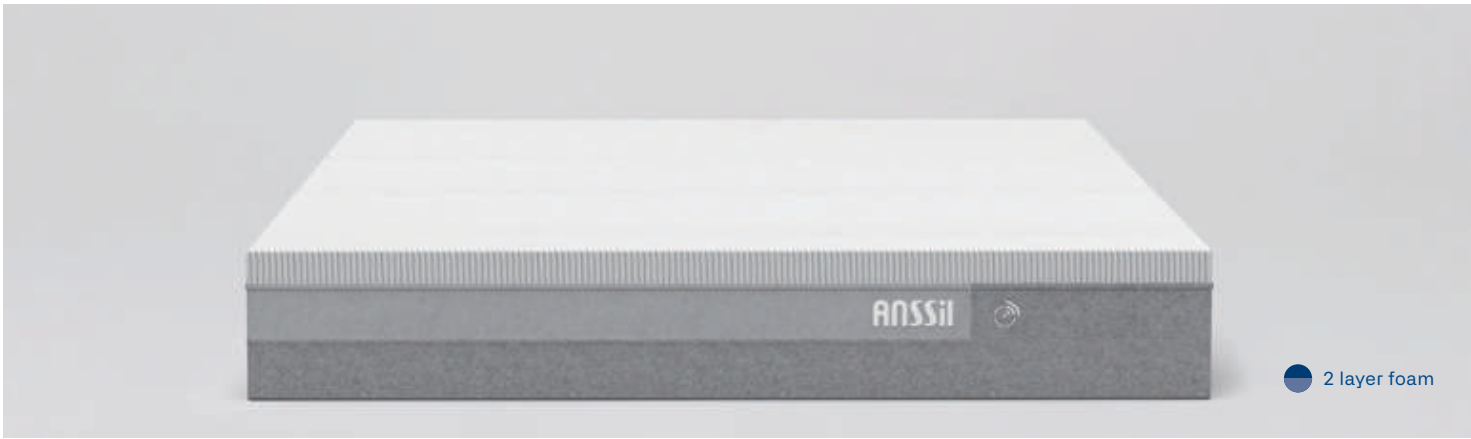

2 layer foam

ANSSil Smart Line Mattress

product string support + topper
 + body pressure sensor + IoT controller
 + ANSSil Link APP

color gray



Smart IoT Controller

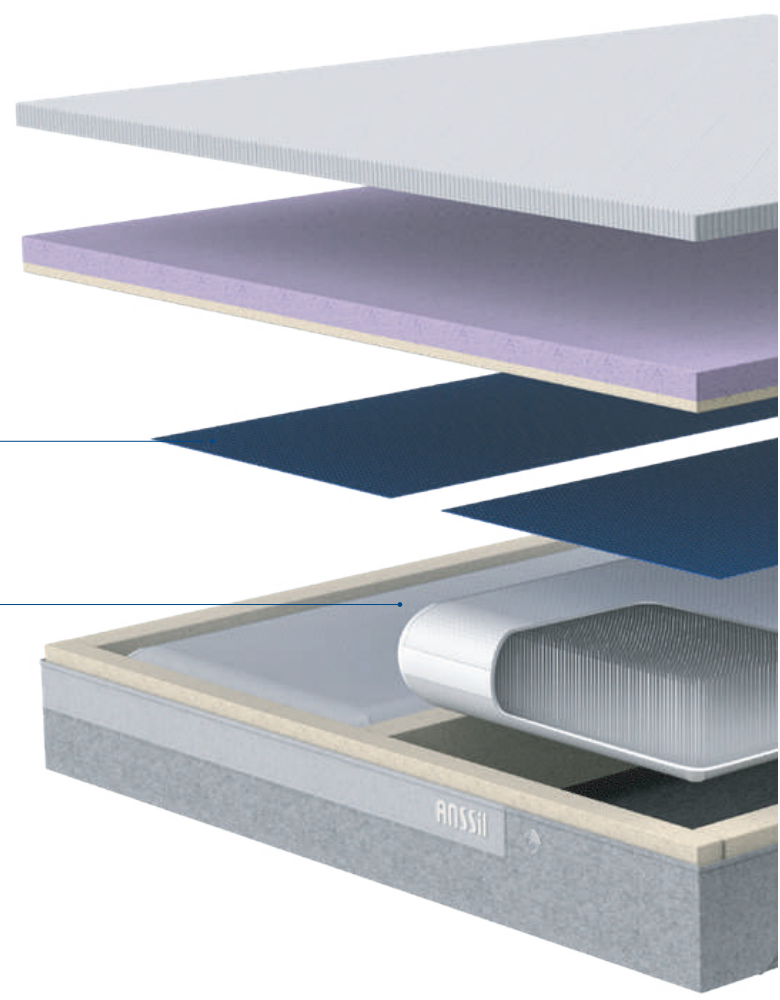

Body Pressure Sensor V1

String Support





ANSSil Link App
CES 2022 innovation award
 - Smart Home
CES 2023 innovation award
 - Smart Home / Digital Health /
 Home appliances

Anssil Smart Line Mattress		W	L	H
King	SKU:ASL-01A	180 cm	190 cm	33 cm
Super Single	SKU:ASL-01C	107 cm	190 cm	33 cm

All dimensions are measured in centimeter (cm).



-  natural latex
-  memory foam

ANSSil Premium Hybrid Line Mattress

product string support + topper + top pad
 color oak tweed cover

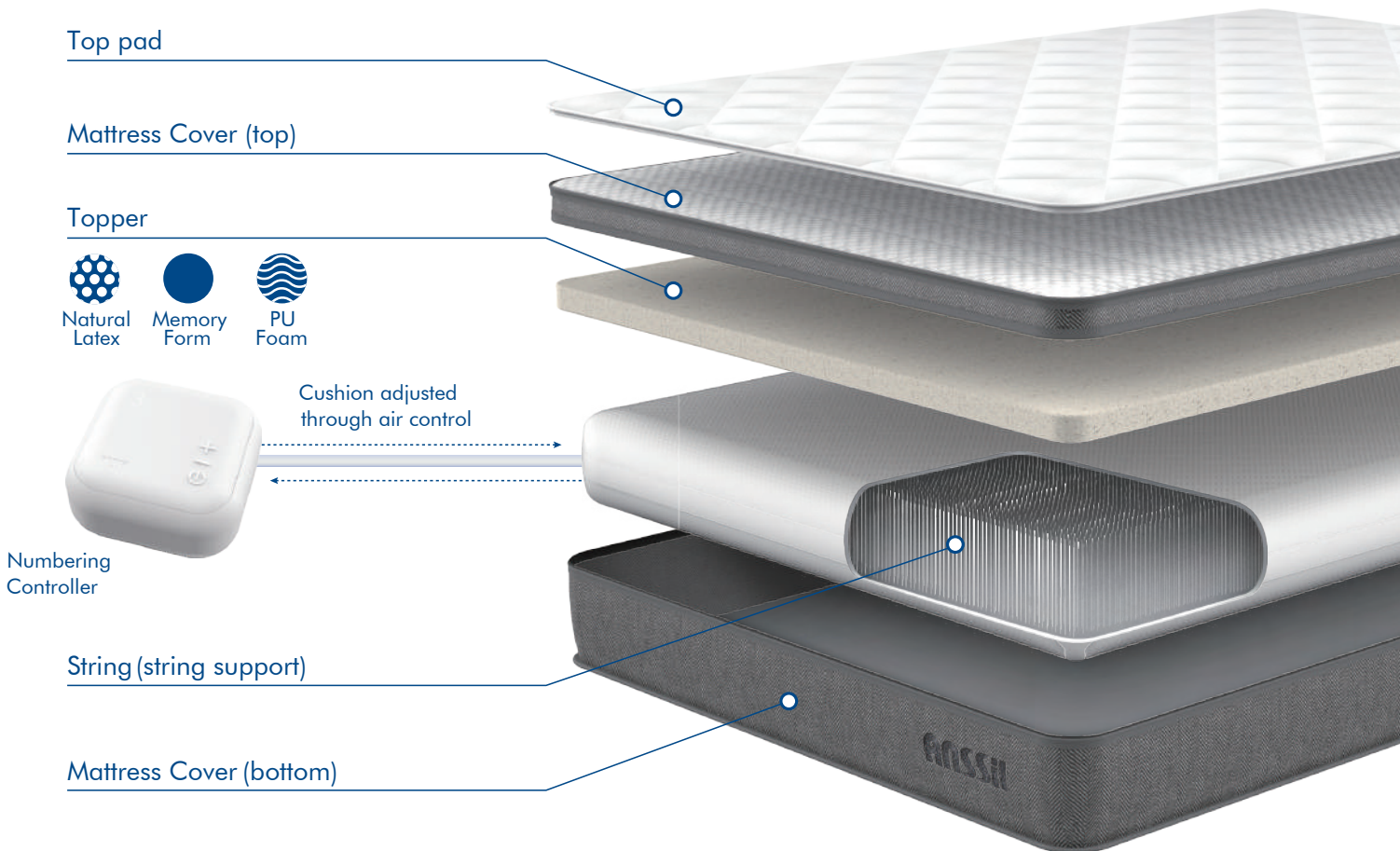

ANSSil Premium Hybrid Line Mattress	W	L	H
Split King SKU:APHL-01SK	180 cm	200 cm	28 cm
King SKU:APHL-01A	180 cm	190 cm	28 cm
Queen SKU:APHL-01B	150 cm	190 cm	28 cm
Super Single SKU:APHL-01C	107 cm	190 cm	28 cm
Single SKU:APHL-01D	91 cm	190 cm	28 cm

All dimensions are measured in centimeter (cm).

String support & Controller

The spring supporter consisting of 14 million strings combined with the firmness controller that sets ideal cushioning to perfectly fit your body for optimal sleeping condition.

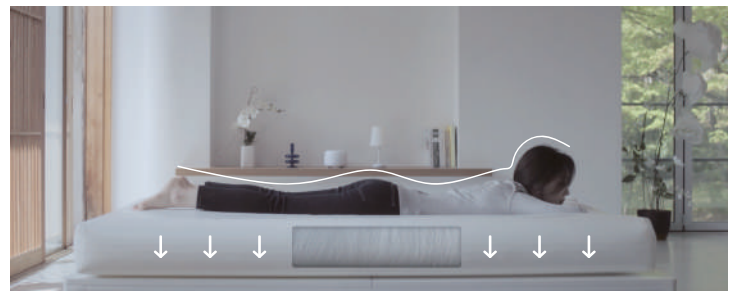

Level 1/ soft



Level 10/ stone hard

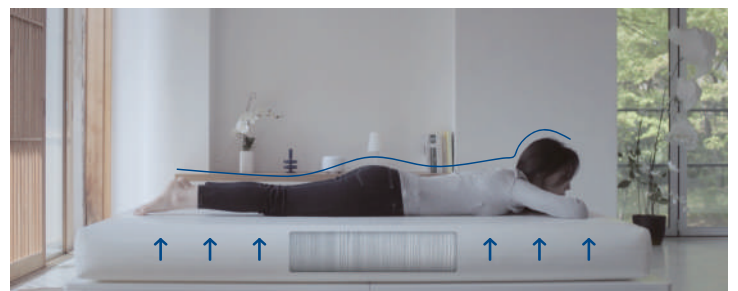

Mattress that lasts a lifetime



Customize firmness in real time



Even distribution of weight and pressure & prevention of balloon effects



A mattress good for Earth



Clean care & Mattress Hygiene









Keeping you safe from harmful substances



No chemical technology

ANSSil

String Mattresses Unveiled: Find Your Dream Sleep

	Structure	Topper	Control System	Colour	Size (cm)
 Anssil Premium Hybrid Line Mattress	 10-14 million strings	Natural Latex or Memory Foam	 IoT Controller	Oak Tweed	Super King 180 x 200 x 28 King 180 x 190 x 28 Queen 150 x 190 x 28 Super Single 107 x 190 x 28 Single 91 x 190 x 28
 Anssil Smart Line Mattress	 14 million strings	Two - Layer Comfort Foam	 Smart IoT Controller 2.0 and Sleep SYNC App	Grey	King 180 x 190 x 33 Super Single 107 x 190 x 33



Less than 2% shrinkage



String stronger than metal



14 million strands



String Cushion Control System



Emma Diamond Hybrid Mattress

The most awarded hybrid mattress in Europe

The brilliance of diamonds for cooler, deeper sleep
Features Emma Diamond Degreed patented technology. Never sleep hot with the high density foam layer infused with graphite dust for temperature regulation.

- Temperature regulation for better and deeper sleep
- Provides comfort in all sleeping positions
- Adaptive support to alleviate back and joint pain

Dimensions

Single: 90 x 190 cm (35" x 75")
Super Single: 107 x 190 cm (42" x 75")
Queen: 150 x 190 cm (59" x 75")
King: 180 x 190 cm (71" x 75")

All sizes have a height of 25cm

Diamond Degree® Graphite Foam

Adaptive comfort foam | Pocket springs | HRX Foam
The colours of the foams are subject to change.
This does not affect its quality or your comfort

Certifications

Our mattresses are not only made from highly durable, premium materials, the cover is certified to OEKO-TEX® Standard 100, Class 1.

Mattress Cover

Removable and washable, the top of the cover is made of 99% polyester and 1% elastane, the bottom is made of 100% polyester, and the base is made of 87% polyester and 13% polypropylene.

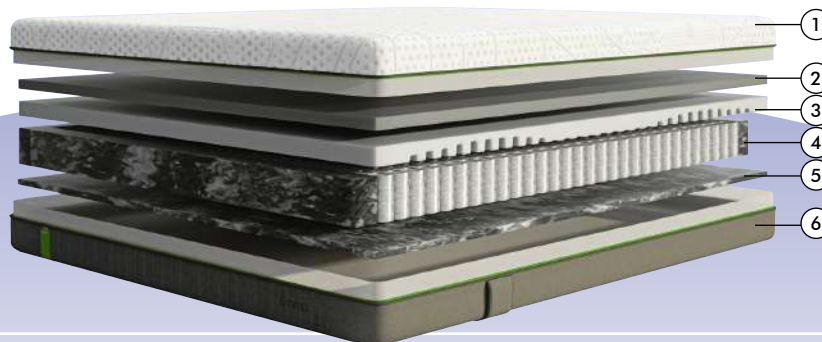

1. Emma UltraDry™ Breathable Cover

This cover is designed specifically to help facilitate the heat dissipation of the Diamond Degree® graphite foam, while integrating Emma UltraDry™ Technology.

2. **Diamond Degree®** Foam that regulates your temperature and absorbs your body heat.

3. **Comfort HRX Foam** that distributes body pressure

4. **AeroFlex®** Pocket Springs for motion isolation and durability

5. **Supportive HRX Foam** for stress-free sleep

6. The layer for backup stability and handles
The bottom of our **UltraDry®** covers is made of anti-slip fabric to bring extra stability. Plus, it features handles for easy set-up.



Emma Original Hybrid Mattress

The most awarded hybrid mattress in Europe

A hybrid between memory foam and spring to give you both comfort and support.

- Pressure-relieving comfort meets enhanced support
- Ultra breathable - Perfect for Singapore's climate
- Ultimate comfort with ideal spinal support and alignment
- Ensures undisturbed sleep throughout the night by motion isolation

Dimensions

Single: 90 x 190 cm (35" x 75")
 Super Single: 107 x 190 cm (42" x 75")
 Queen: 150 x 190 cm (59" x 75")
 King: 180 x 190 cm (71" x 75")

All sizes have a height of 25cm

Mattress Core Construction

Supportive polyether foam
 Pressure-relieving point-elastic foam

Cover Layer Material

Removable and washable top cover: 99% polyester and 1% elastane

Side cover: 100% polyester

Bottom cover: 87% polyester and 13% polypropylene

Certifications

Each individual layer of the Emma Original Hybrid Mattress complies with the OEKO-TEX® Standard 100 - Class 1 (Certificate Number: 16.0.93305).

This certification assures that our product is free of harmful substances and is safe for babies and toddlers.



1. The Emma UltraDry™ breathable cover

A fully breathable, removable, and machine-washable cover.

2. Point Elastic Airgocell® Foam for breathability

Our groundbreaking Point-elastic Airgocell® technology enhances breathability and regulates temperature.

3. Halo Memory Foam™ for adaptive pressure relief

This memory foam layer adapts and molds itself to the shape of your body, promoting spinal alignment and optimal pressure relief.

4. AeroFlex® Pocket Springs encased in HRX Foam for durability and support

This layer has pocket springs that are zoned to the 5 parts of your body that need support (head, shoulders, hips, knees, feet). from

5. The layer for backup stability and handles

The bottom of our UltraDry® covers is made of anti-slip fabric to bring extra stability. Plus, it features handles for easy set-up.



Contact Us _____

AFFAIRS™
SMART FURNISHING

Affairs Living Singapore

Affairs Living Pte. Ltd.
Gemini@Sims HQ (Showroom)
2 Sims Close #01-13
Gemini @ Sims Singapore 387298
(8 mins walk from Aljunied MRT)

Email: askme@affairs.sg
Whatsapp: +65-96535877

**BEDDING AFFAIRS™**
Trends. Comfort. Moods.

Bedding Affairs Malaysia

Bedding Affairs Sdn. Bhd. (1325629H)
No.1, Block C, Jalan Dataran SD1, Bandar Sri
Damansara, Ground Floor, 52200 Kuala Lumpur
(Next to Sri Damansara LRT)
Free Parking Daily on refund basis

Email: askme@beddingaffairs.com
Whatsapp: +6011-58903014
Office: +60362632890