

WYNDHAM
COLLECTION

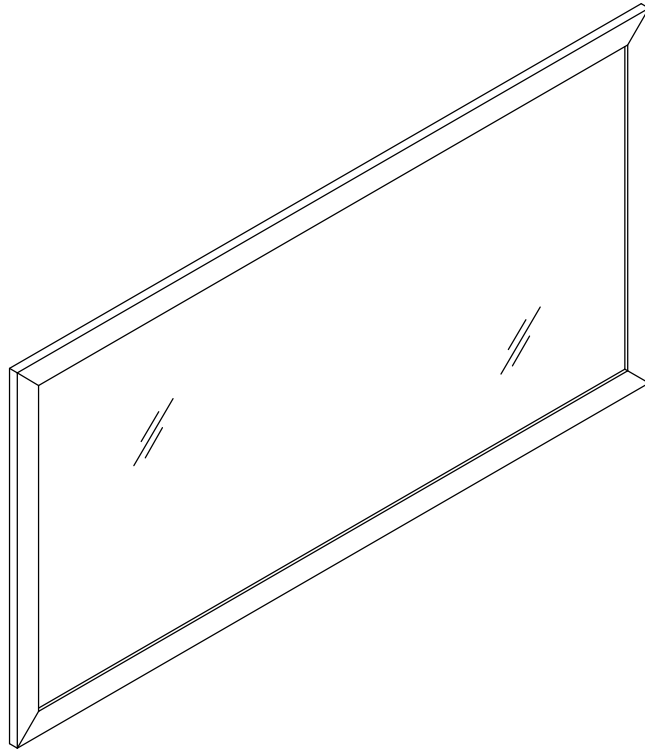
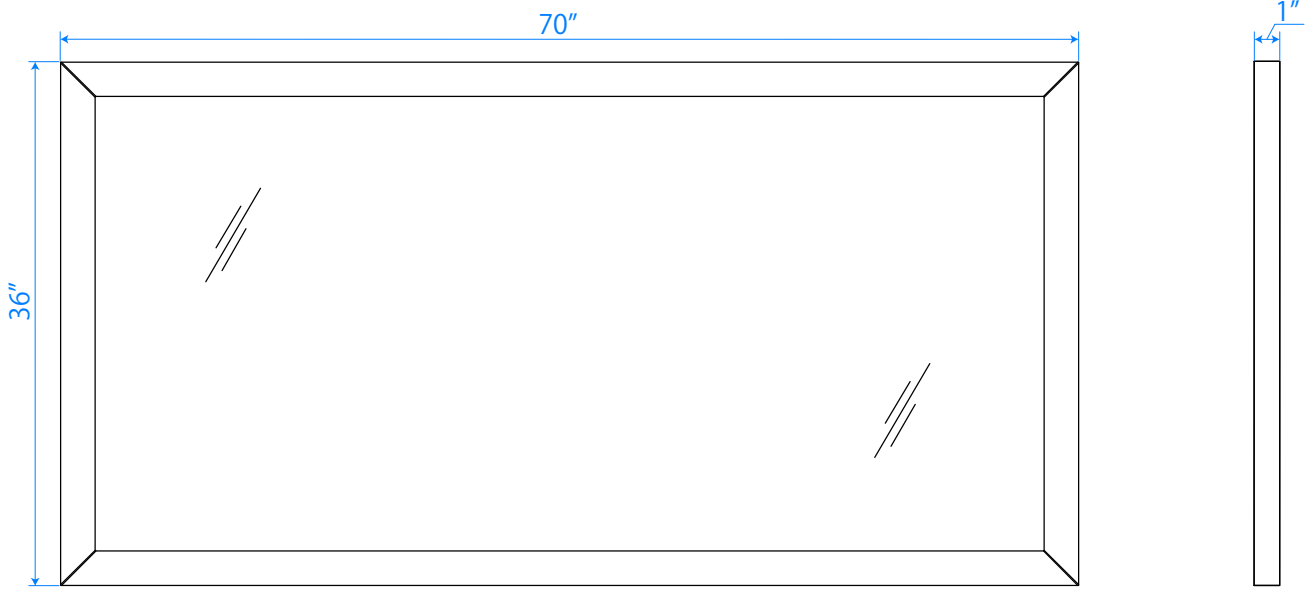

Note: All Measurements are $\pm 1/4"$

WC-1111-M70