

WYNDHAM  
COLLECTION

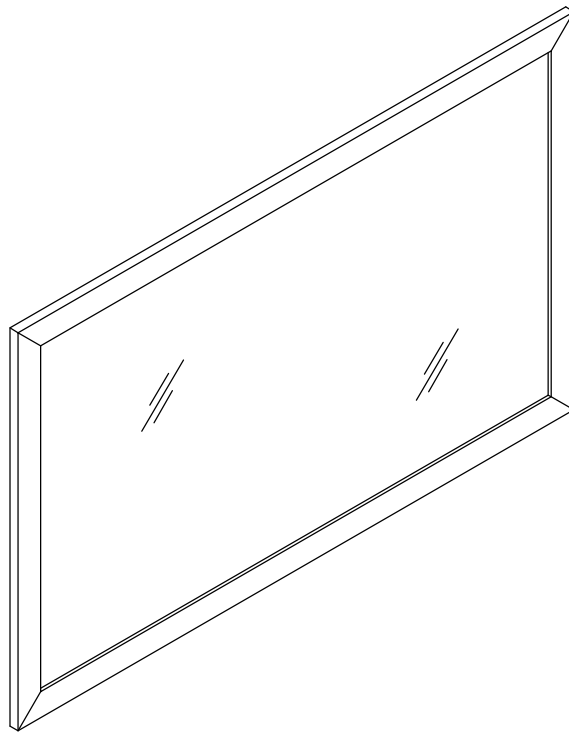
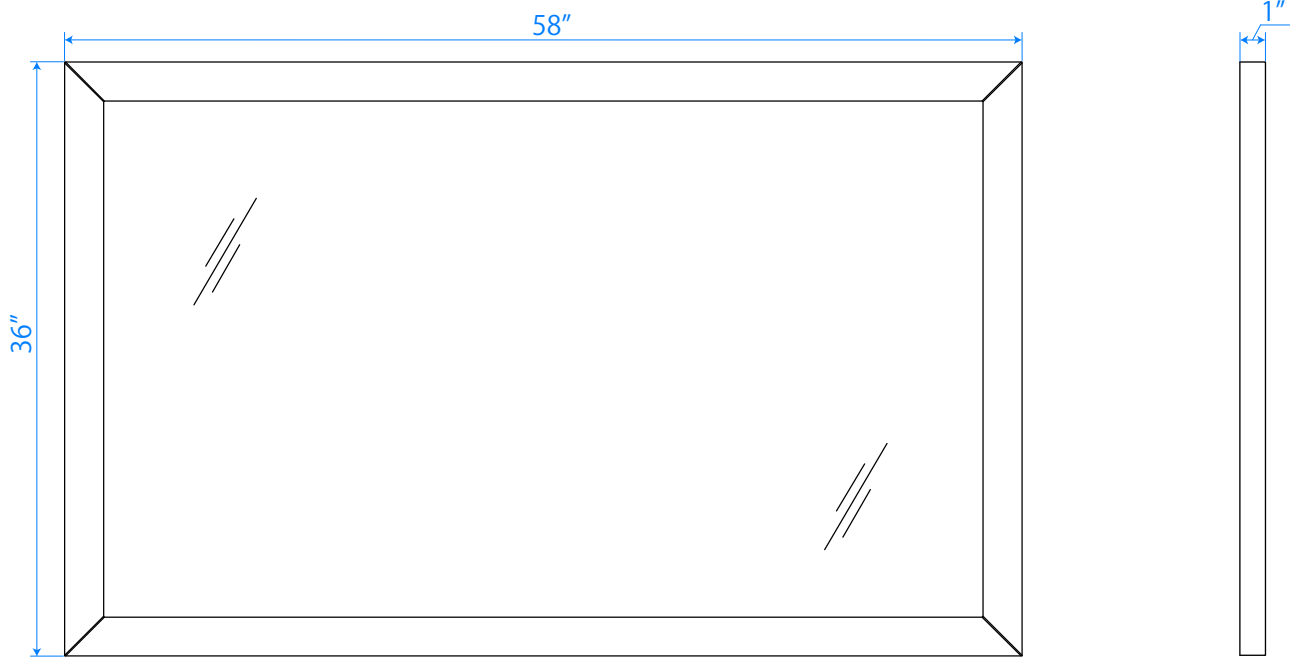

Note: All Measurements are  $\pm 1/4"$

WC-1111-M58