

This model consists of individual cabinets to make the complete set.

Prior to installation, please check the items you have received against the packing list. Report any missing items to your local dealer immediately.

Protect all surfaces from sharp objects, high heat sources, direct prolonged sunlight and chemical hazards.

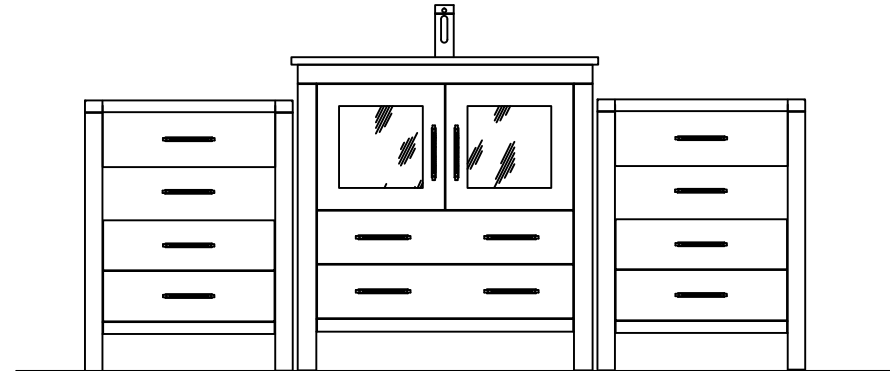

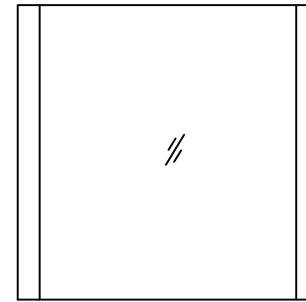

Professional installation is recommended.

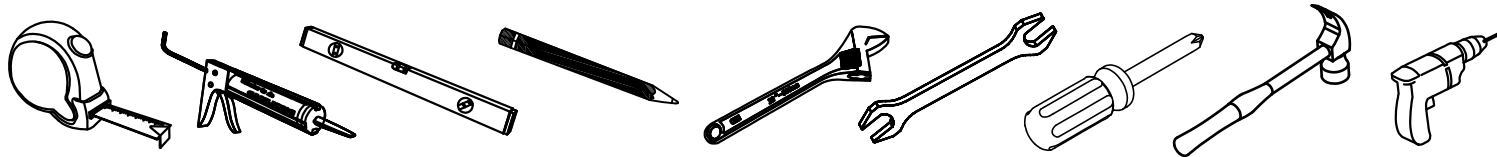

REQUIRED TOOLS

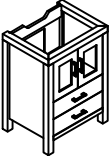

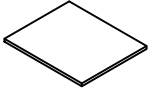
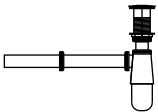
PARTS LIST (may differ depending on purchase)

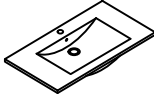
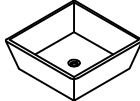
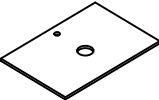
<p>Cabinet</p>  <p>KS-70030</p>	<p>Mirror</p> 	<p>Side Cabinet</p>  <p>KSC-700</p>	<p>Side Top</p> 	<p>Pop-Up & Drain</p> 	<p>Faucet</p> 	<p>Basin Integrated</p> 	OR	<p>Basin Vessel</p> 	<p>Top Vessel</p> 
--	---	--	---	---	---	---	----	---	---

Mirror Installation

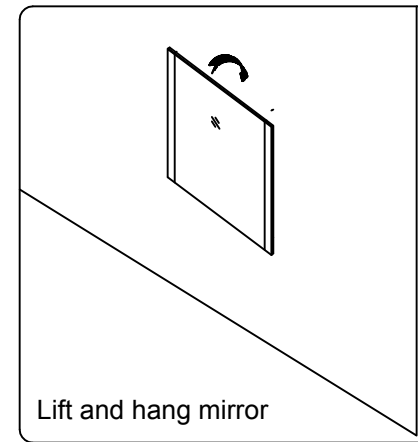
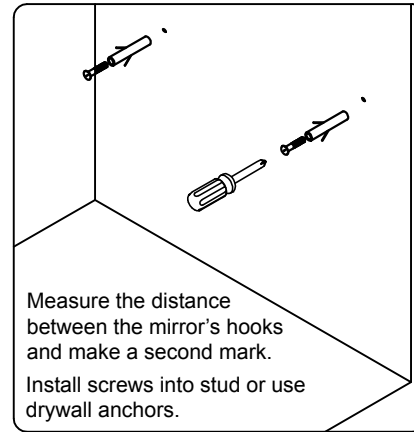
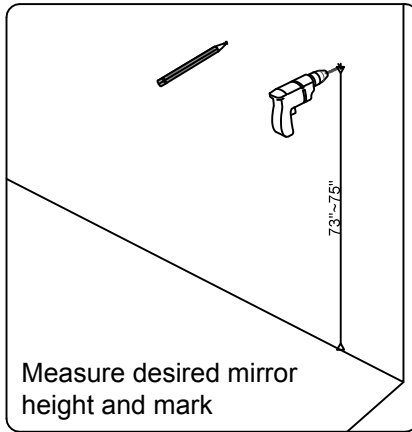

Top Installation (Integrated Basin)

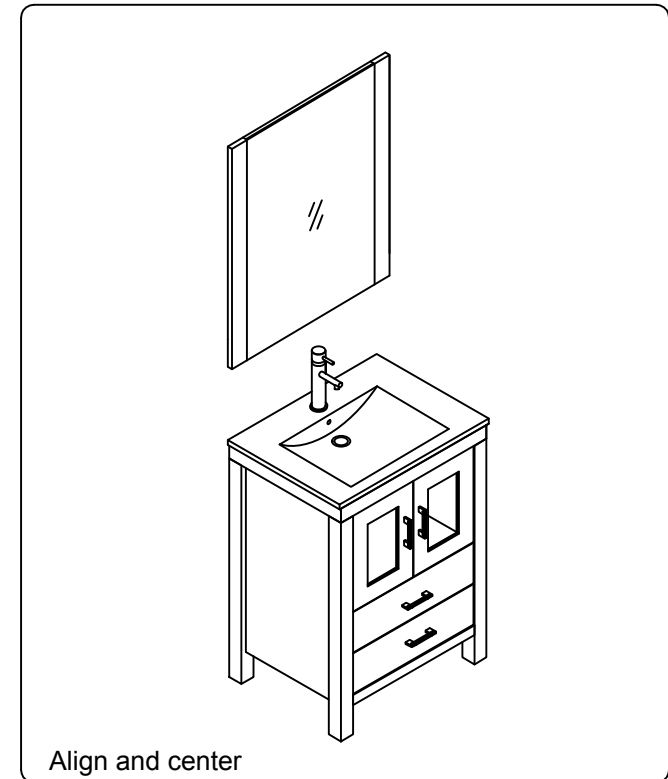
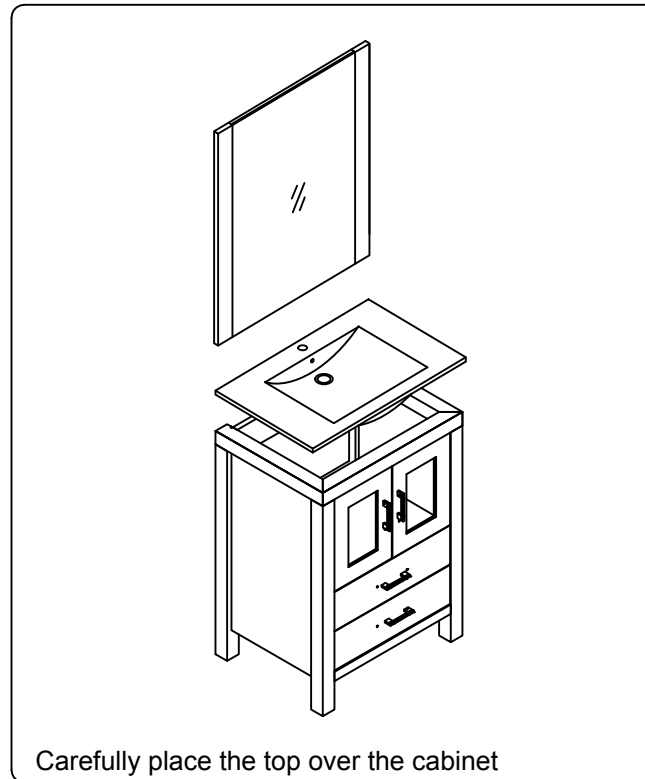
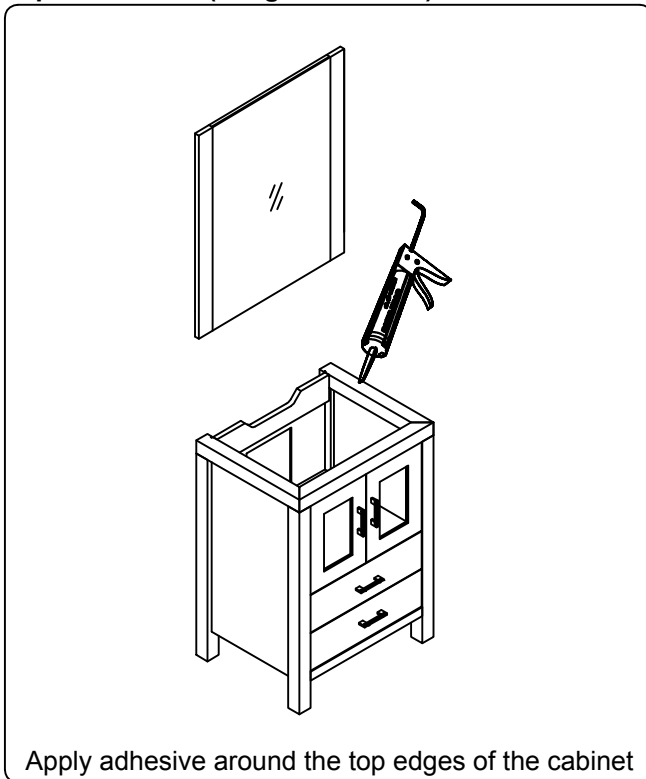

Top Installation (Vessel Basin)

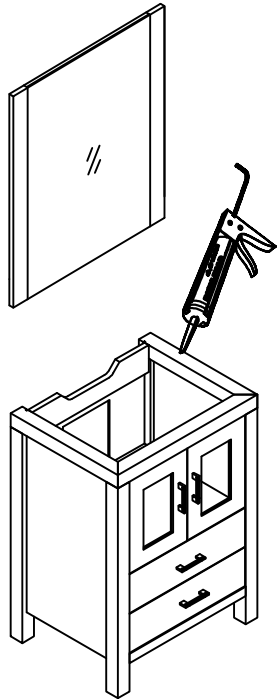

Apply adhesive around the top edges of the cabinet

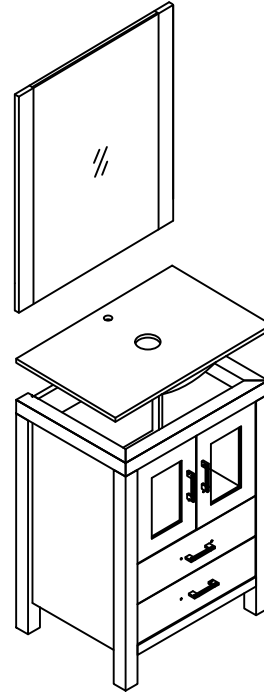

Carefully place the top over the cabinet

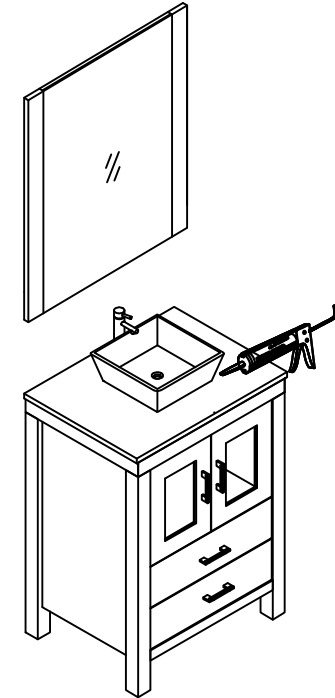

Align and center

Side Cabinet

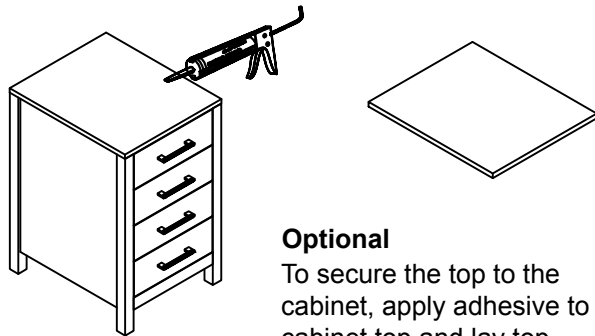

Optional
To secure the top to the cabinet, apply adhesive to cabinet top and lay top.

Pop-Up & Drain

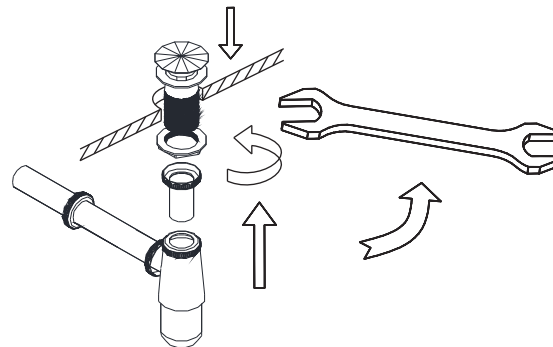

Faucet

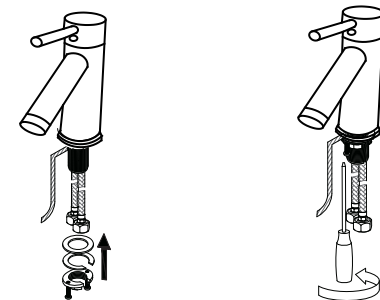

DRAWER REMOVAL

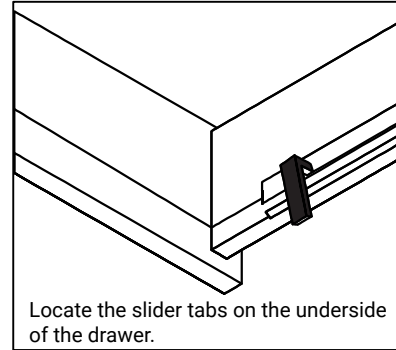
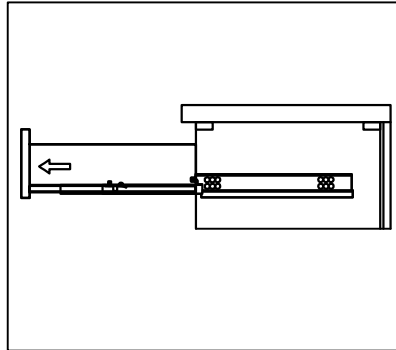
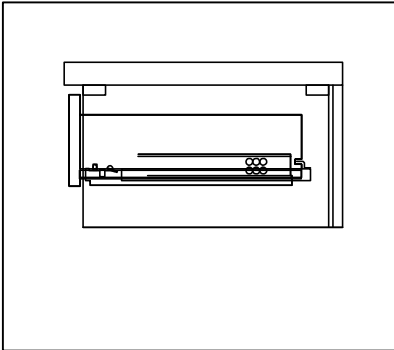

REMOVAL

1. Pull tabs toward center
2. Lift and pull drawer out

RE-INSTALL

1. Align drawer hole with slider stud
2. Push tabs back in to secure

DOOR ADJUSTMENT

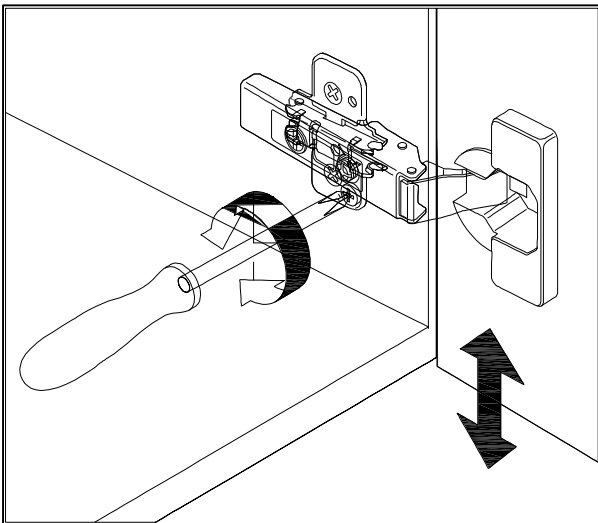

Adjusts the door vertically

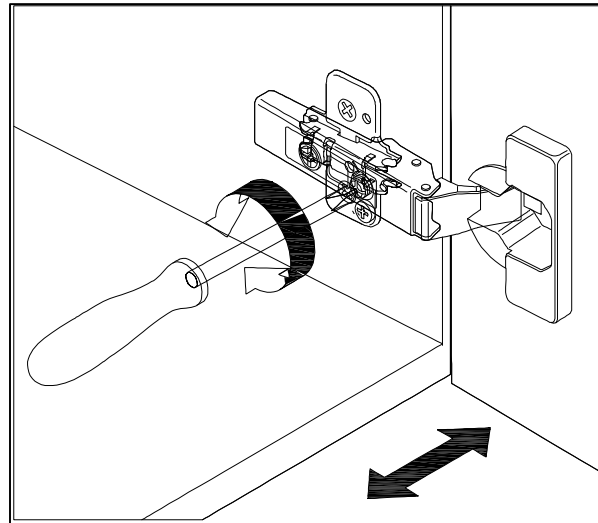

Adjusts the door horizontally

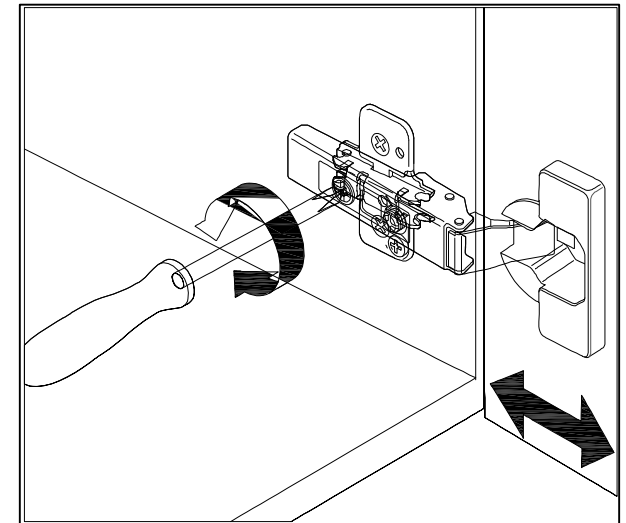

Adjusts the door forward and backwards