

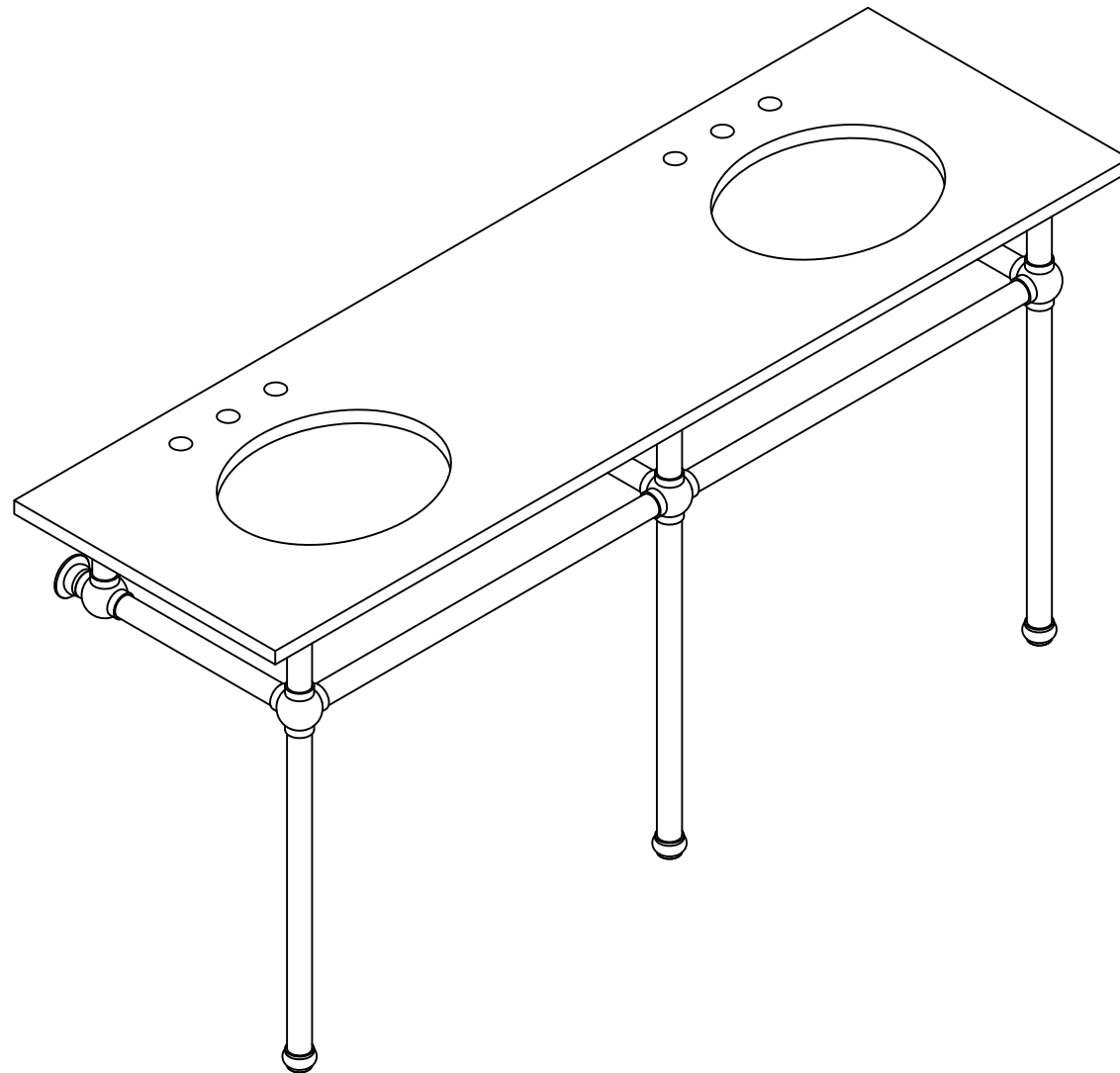

MODEL: EMPIRE60 72 / EMBASSY60 72

WASH STAND INSTALLATION GUIDE



MODEL: EMPIRE60 72 / EMBASSY60 72







Recommended Tools:

- Drill - Level - Hammer
- Pencil - Silicone
- Phillips head screwdriver
- Safety Glasses

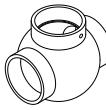
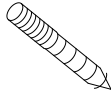
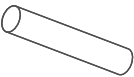
BEFORE YOU BEGIN ** IMPORTANT **

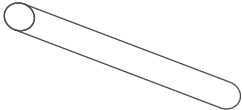
- 1) Professional installation by two-person crew is required for this fixture
- 2) Assemble this fixture on a soft blanket is highly recommended
- 3) We do recommend installing wood blocking inside your wall to add support to your stand. You will need to use heavy duty anchors (such as steel or toggles) if you choose not to install wood blocking
- 4) Gently slide the joint onto support bar to avoid scratch

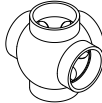
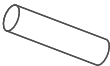
PARTS

(A) Escutcheon x 9 pcs	(E) 3-Way Joint x 3 pcs	(I) Floor Screw x 3 pcs
		
(B) Side Bar x 3 pcs	(F) 4-Way Joint x 2 pcs	(J) Screw & Anchor x 9 pcs
		
(C) Support Bar x 3 pcs	(G) Front Bar x 2 pc	(K) 5-Way Joint x 1 pc
		
(D) Support Bar x 3 pcs	(H) Foot Flange x 3 pcs	
		

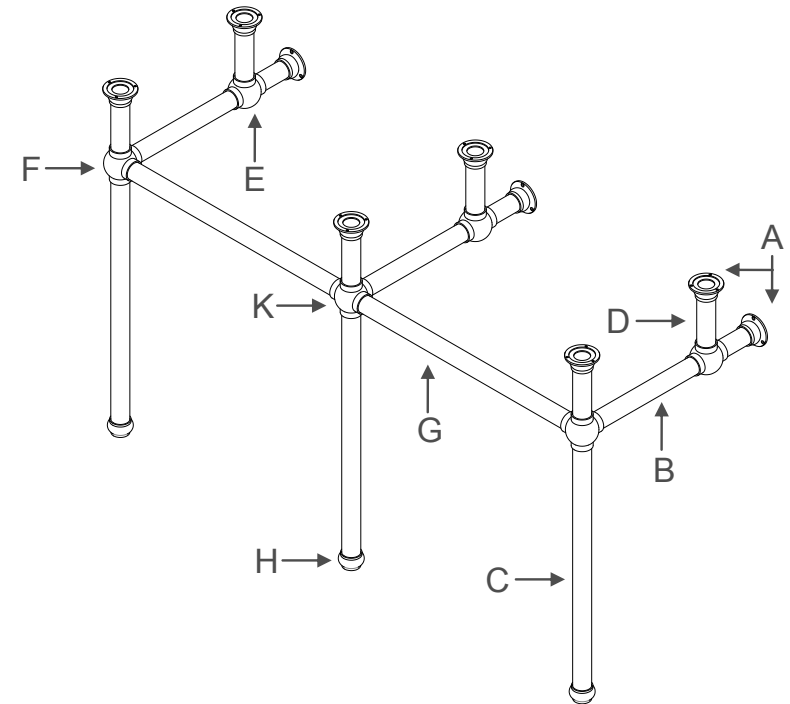

INSTALLATION STEP

- 1) Assemble the back support as shown. Tighten set screws on the escutcheons and 3-way joints.
- 2) Assemble support legs as shown. Use a level to ensure the top escutcheons are straight. Tighten set screws on the 3-way joints, 4-way joints, 5-way joint and all escutcheons.

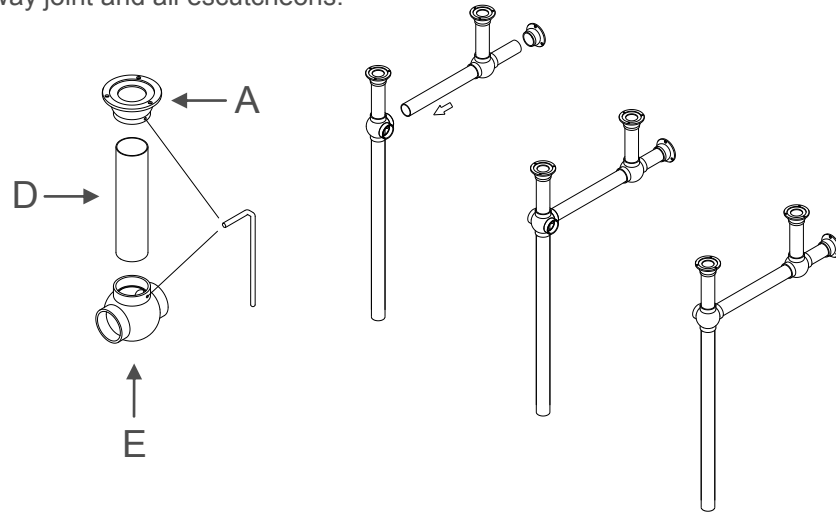

- 3) After assembling both sides support legs and central support leg, attach front bars to join legs together and tighten set screws.
- 4) With one person on either side of assembled stand, carefully position the wash stand in desired location. Use a pencil mark position of wall escutcheon screw holes on wall as well as the perimeter of the location of foot flanges on floor.

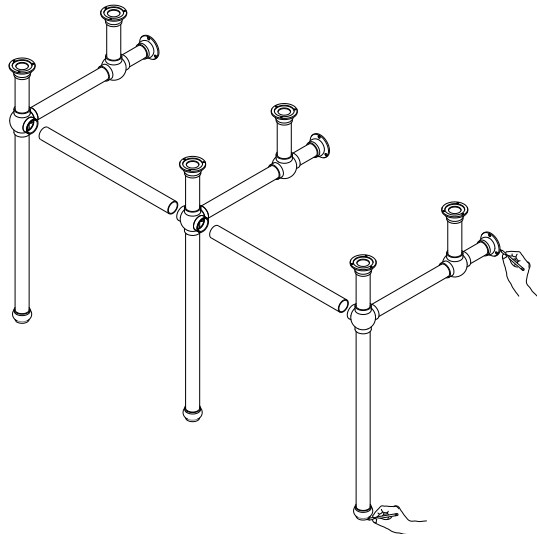

- 5) Thread the floor screws with foot flanges and screw it into floor.
- 6) Drill holes on wall for wall escutcheons and push anchors flush with wall
- 7) Insert the support legs into foot flanges and fasten wash stand to wall with mounting screws.
- 8) Apply a thin coat of silicone on the top flanges to secure the counter top to stand.
(If counter top need slight leveling adjustment, place attached sponge pads on escutcheons as necessary to stabilize.)

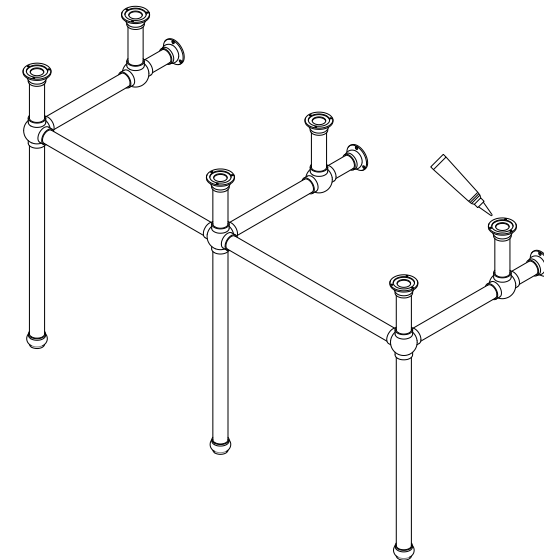

MARBLE TOP INSTALLATION

Storage:

1. Keep marble top in it's box until installation
- 2: Store box vertically in a place safe from being hit or knocked over
3. Do not stack anything on top of the box

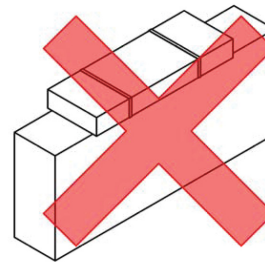
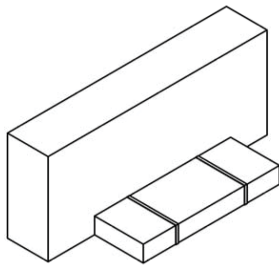

Opening Box:

1. Before unpacking please make sure you have installation requirement present:
 - > A professional two man crew
 - > Tools and materials required:
 - a. Flat, non-abrasive work surface, such as a soft blanket
 - b. Carpenter's level
 - c. Sealant
2. Carefully, without allowing any free fall, rotate the box from vertical to flat.
(This is the only time the box placed horizontally.)

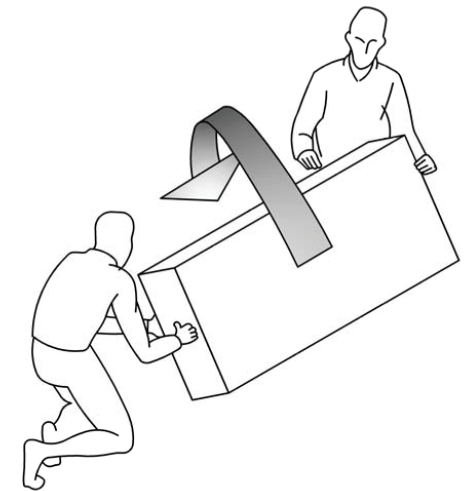

MARBLE TOP INSTALLATION

Installation:

1. Always use a two man crew, a single person crew is much more likley to cause damage
- 2: Apply sealant to secure marble top on washstand

