

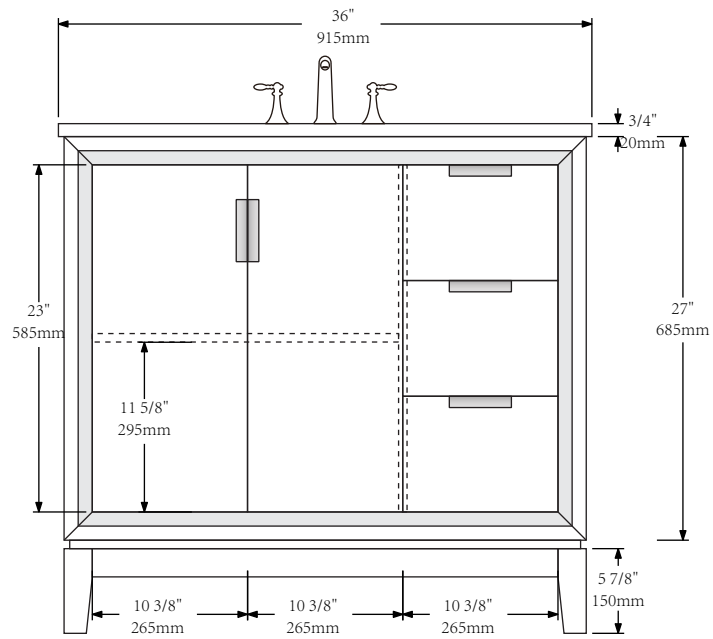

MODEL: ELIZABETH36

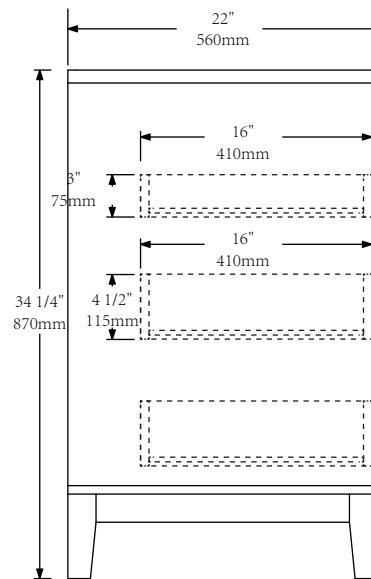

FRONT VIEW



SIDE VIEW

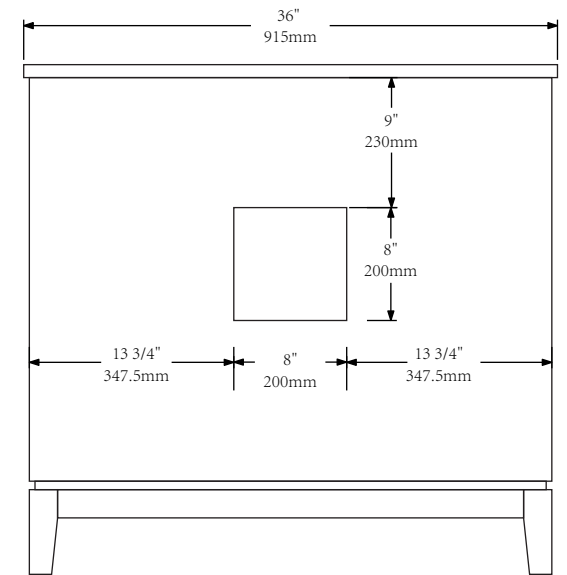

BACK VIEW



MODEL: ELIZABETH36

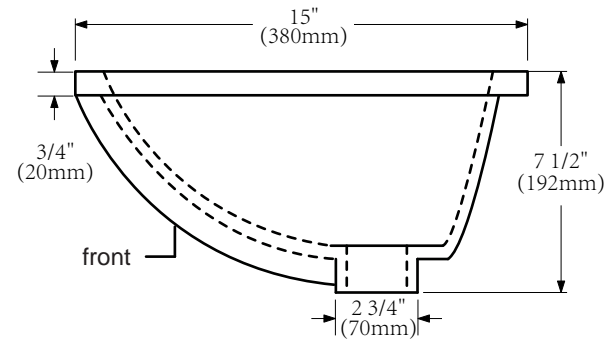
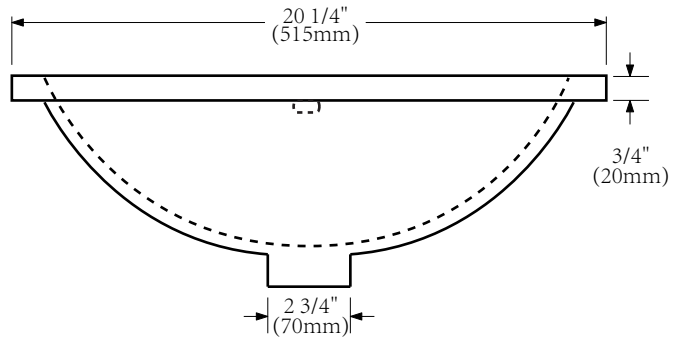
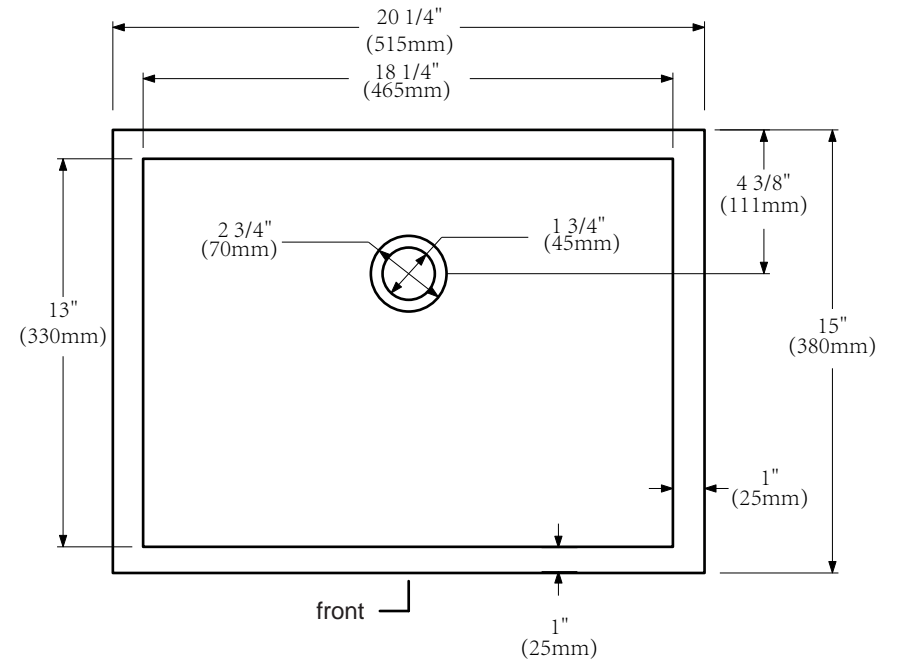
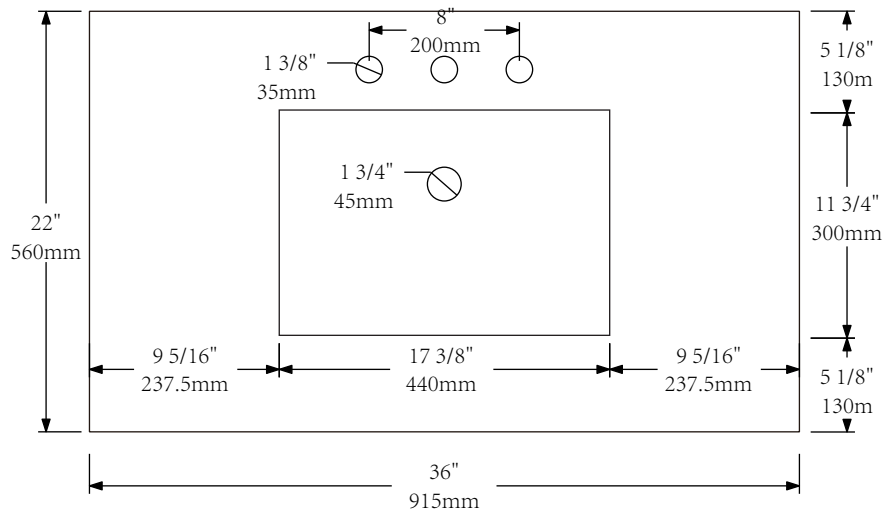



MODEL: F2-0013

