



WILLIAM OPTICS

WIFD REDCAT 71 MANUAL



Specification	2-4
Package Contents	5
Parts	6
Telescope Diagram	7-10
Operation Guide	11-15
Accessories Map	16

Warning

Never aim your telescope or finder scope at the Sun without proper Solar filters installed on the front of the telescope. Doing so for even a moment may permanently damage your vision. Proper Solar filters consist of filters made by reputable manufacturers, designed to fit tightly over the front of the dew shield. Solar eyepiece filters are not considered safe, and should not be used. With proper front mounted Solar filters, the telescope will not be harmed by viewing the Sun.





- **Focal Length** : 350mm (Astrograph)
- **Diameter** : 71mm
- **Aperture** : f/4.9
- **Focuser** : WIFD (WO INTERNAL FOCUS DESIGN)
(Compatible with EAF)
- **Image Circle** : 45mm full frame
- **Tube Length** : 427mm
- **Dew Shield Circumference** : 331mm
- **Dew Shield Diameter** : ϕ 105mm
- **Weight** : 7.11lbs / 3.225kg (OTA only)
9.47lbs / 4.295kg (OTA with
ring, dovetail and saddle)

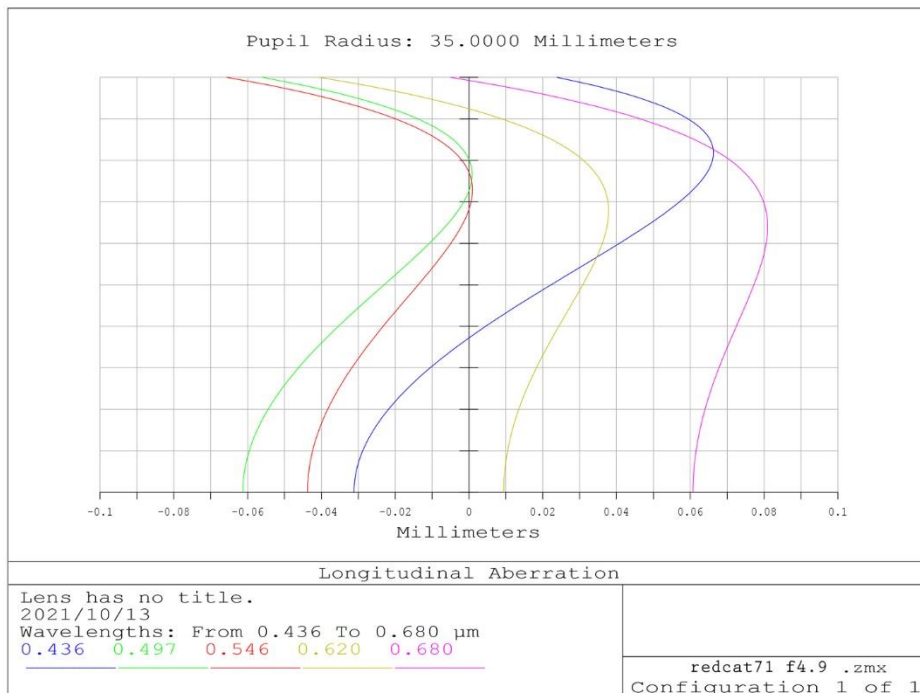
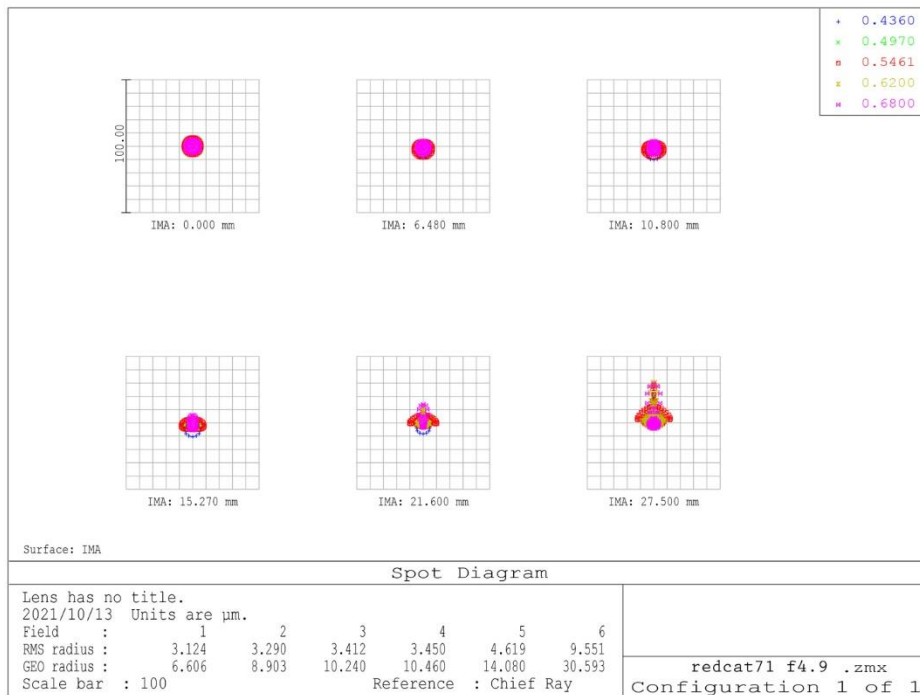

NOTE:

We are utilizing a unique Petzval design featuring four optical elements in the William Optics (WO) Cat series telescopes. This design incorporates the use of high-quality FPL-53 glass for superior optical performance. Before storing your telescope, it is crucial to allow it sufficient time to acclimatize to room temperature. Please ensure that the telescope is thoroughly dry, free of dew or moisture, before storing. This ensures the safety and longevity of the telescope's components.

Always store the telescope in a consistent-temperature and dry environment to prevent any potential damage to the optical elements. Remember to leave the tube uncovered and opened during the acclimatization period. As always, taking appropriate care of your telescope will ensure its optimal performance and extend its lifespan.

Back Focus

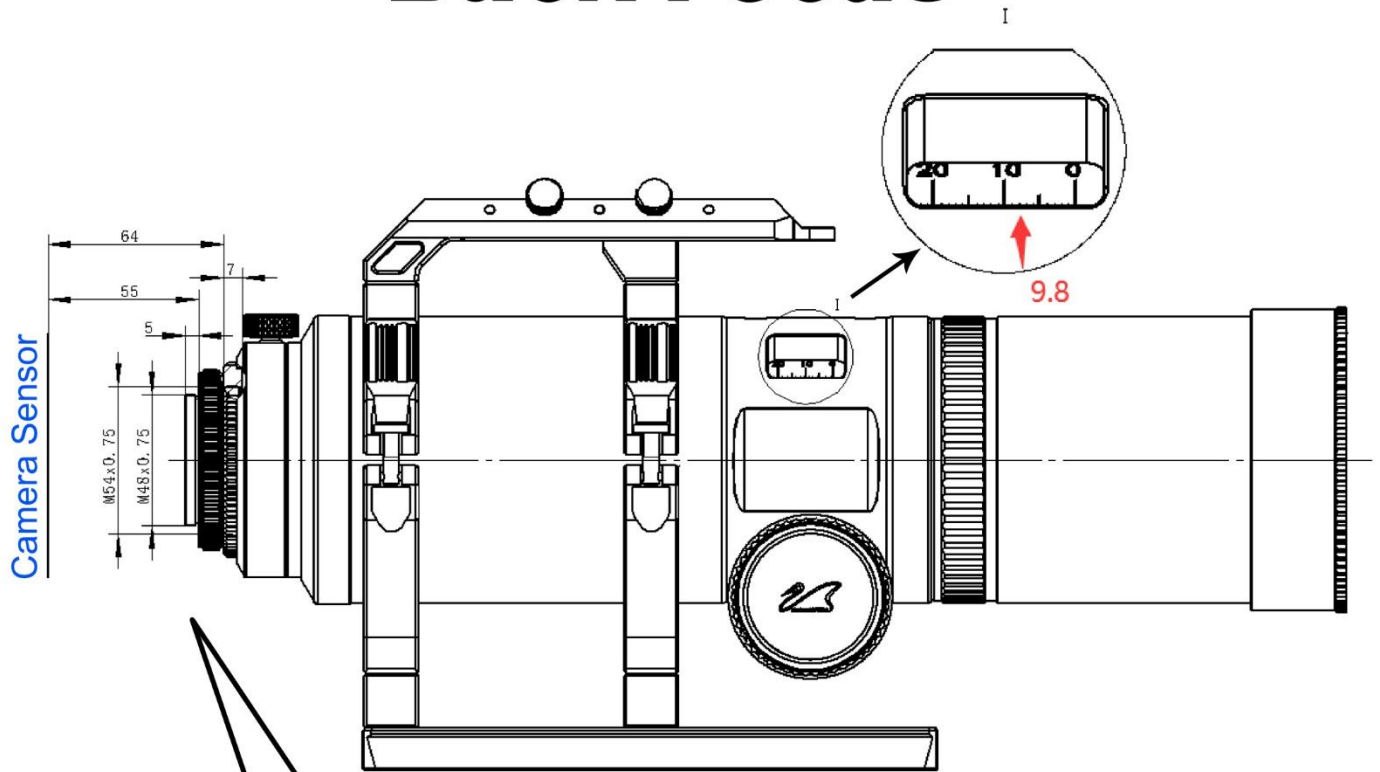

Camera Sensor

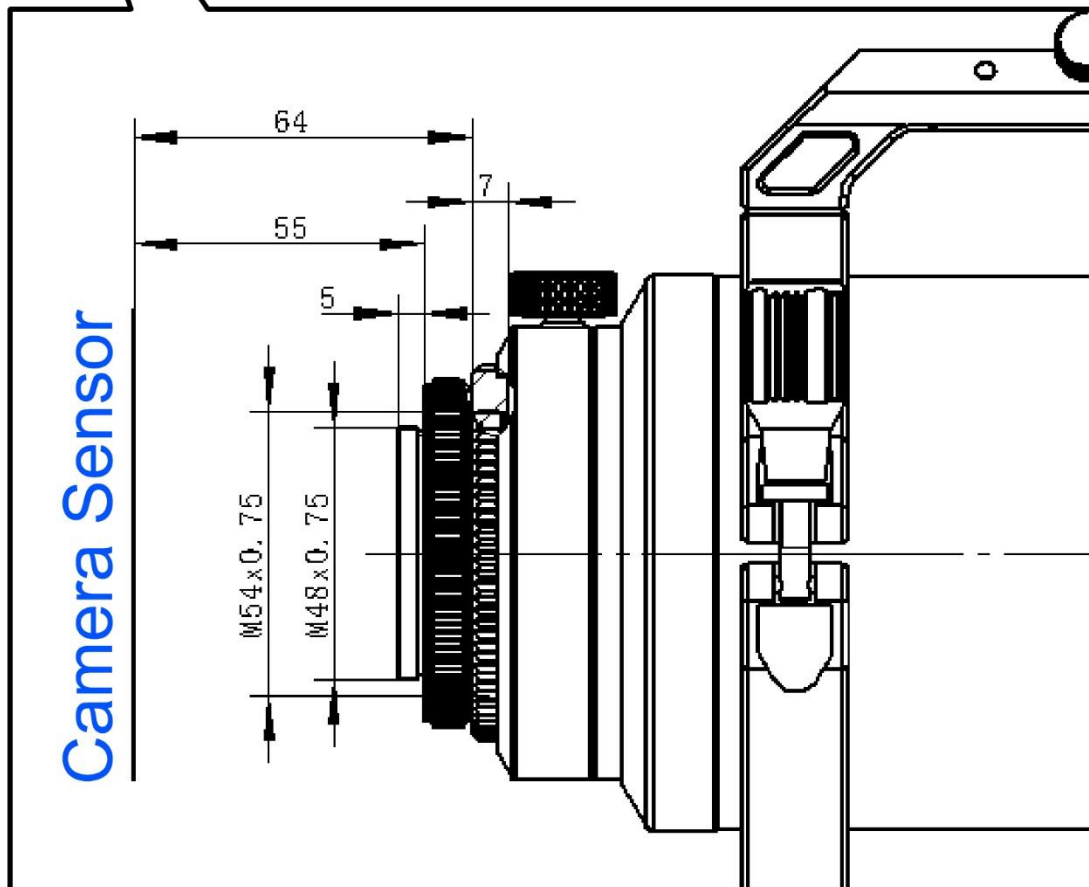

Camera Sensor

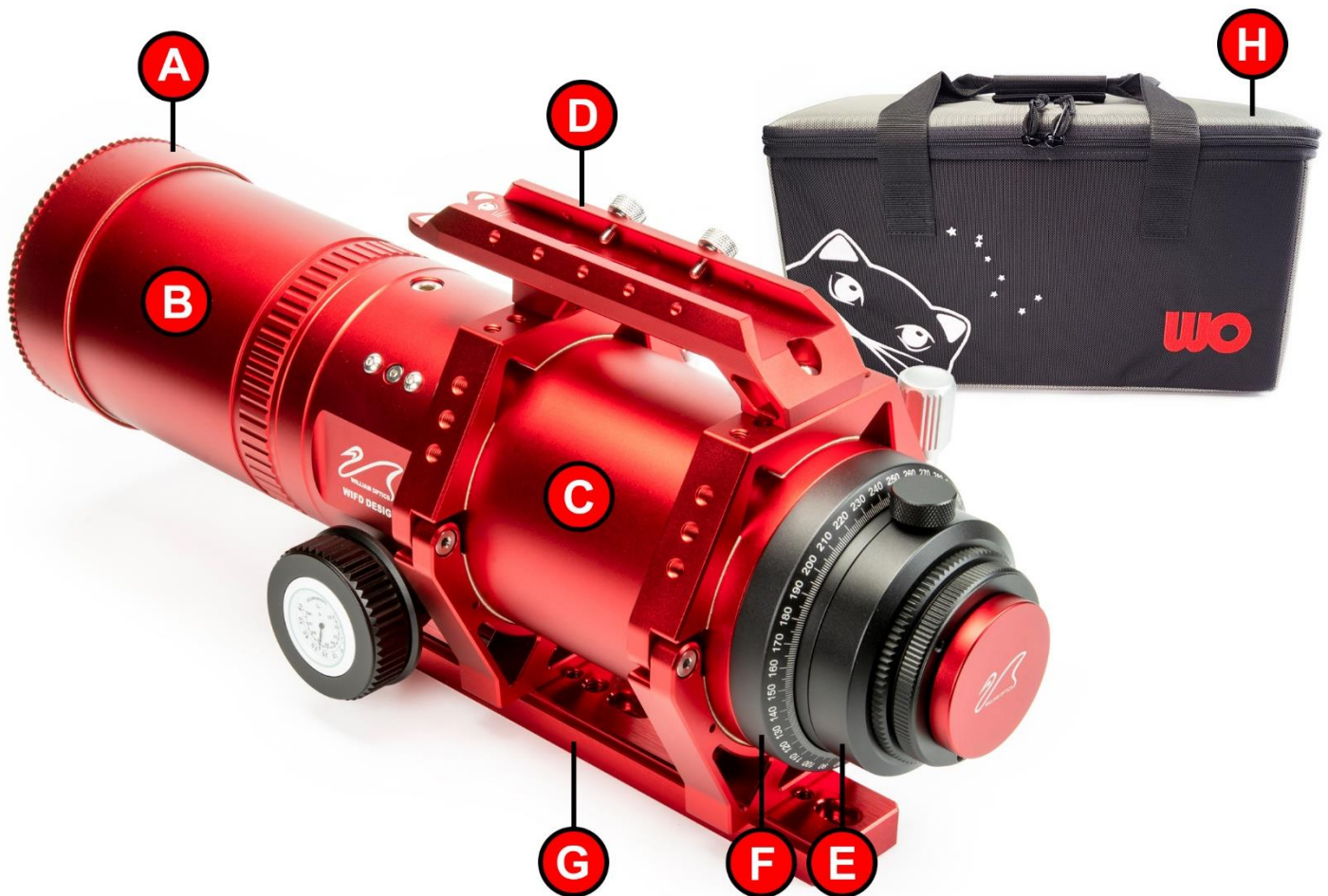

- A. Dust Cover with Bahtinov Mask
- B. Dew Shield
- C. Main Tube
- D. Saddle Handle Bar
- E. Camera Angle Rotation Device
- F. Tilt Adapter (inside)
- G. 210mm Vixen Style Dovetail Plate
- H. Soft Carry Case

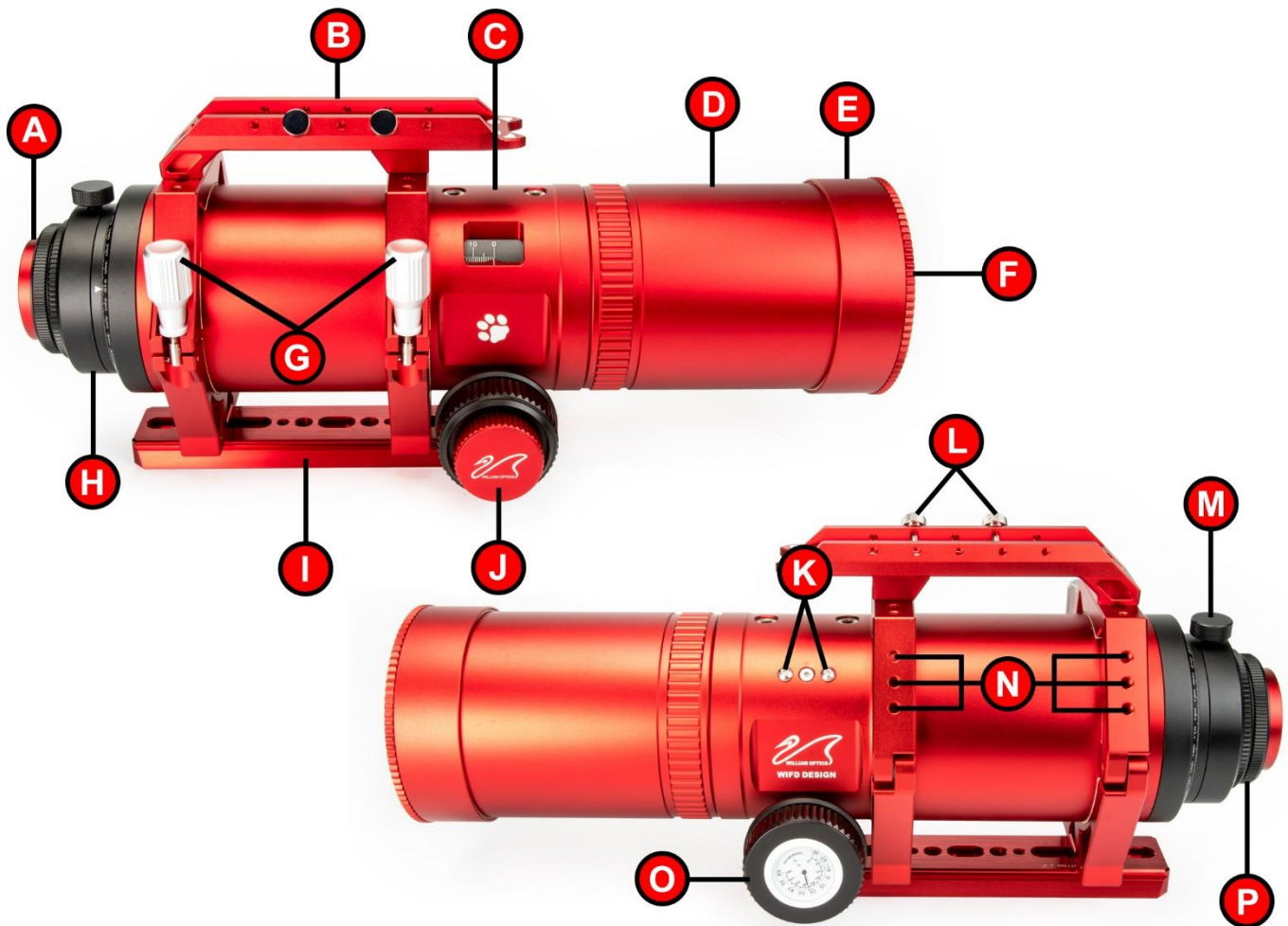

- A. Rear Dust Cap (M48)
- B. Saddle Handle Bar
- C. WIFD Focuser
- D. Dew Shield
- E. Lens Cover with Bahtinov Mask
- F. Front Bahtinov Mask Cover
- G. Mounting Rings / Knobs
- H. Camera Angle Rotator
- I. 210mm Dovetail
- J. 2 Speed 10:1 Ratio Fine Knob

- K. M4 Screw Holes for Finder Bracket
- L. Locking Screws on Saddle Handle Bar (M4)
- M. Camera Angle Rotation Locking Screw
- N. M6 Screw Holes for Finder Bracket
- O. Focuser Adjusting Knob with Thermometer
- P. M48 Adapter (for Camera Mount)



Lens





Camera Angle
Rotation
Locking Screw



Focuser Tension Screw

Do not over
tighten (Release
the lock tension
when focusing)

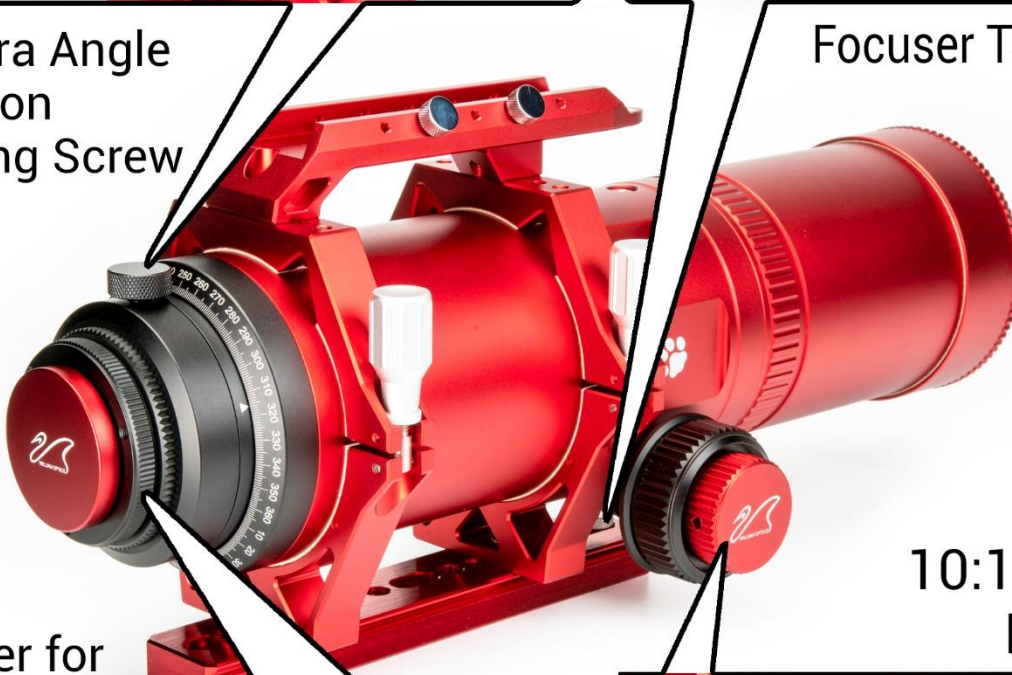

Adapter for
Camera Mount

10:1 Ratio
Fine Knob

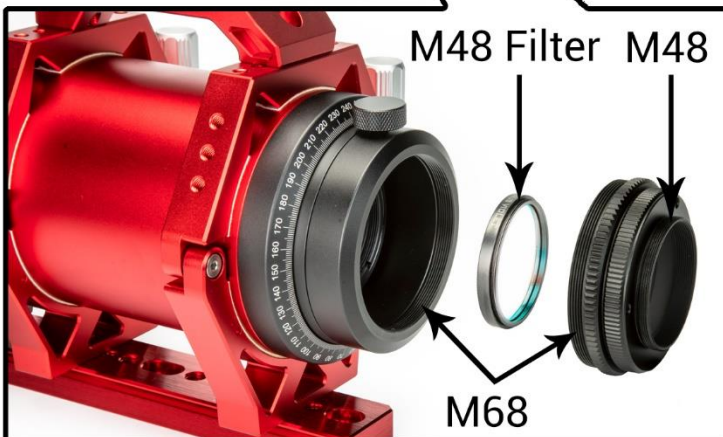



Tension Screws
(for increase focuser tension)

Finder Bracket Holder
Screws (remove both
screws before use)



Use 5mm Allen Key

Use 2.5mm Allen Key

R & P GEAR SPACING SCREWS

- Adjustment Screws (3 mm Allen Key) - Pull Screw
- Adjustment Screws (2 mm Allen Key) - Push Screw
- Can be Removed to Attach the Electronic Motorized Device such as EAF (Please refer to the instructions on page 13)
- Tension Screw
- Do Not Touch



The focuser smoothness adjustment **ONLY** when necessary by progressively push & pull screws until you reach the desired smoothness.

NOTE:

DO NOT ADJUST IT BEFORE ASKING WO

Where Is the Tilt Adapter?

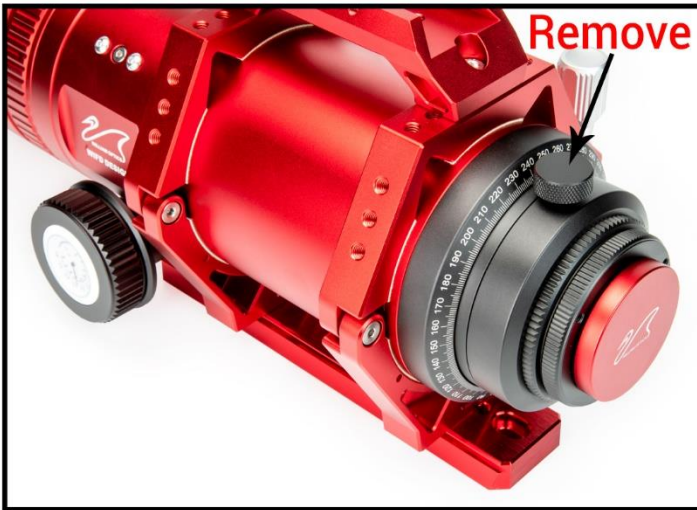

Step 1.

Remove the rotator knob.

Step 2.

Twist the cover.

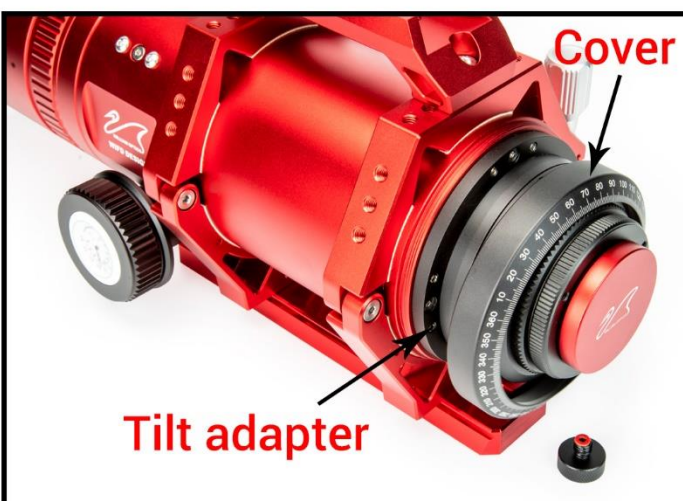
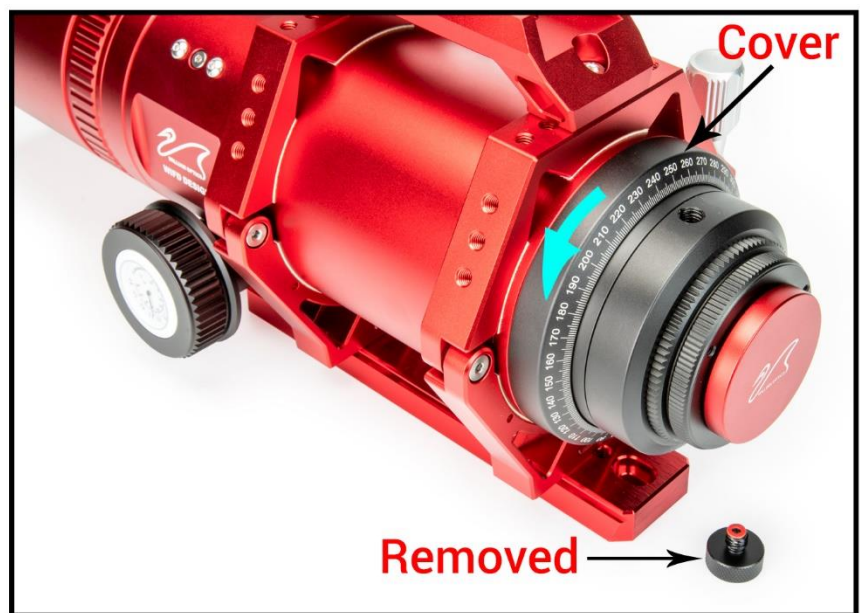

Step 3.

The tilt adapter is inside.

Where Is the Tilt Adapter?



Step 4.

Remove the cover when you need to adjust it.

Step 5.

How to adjust the tilt adapter.

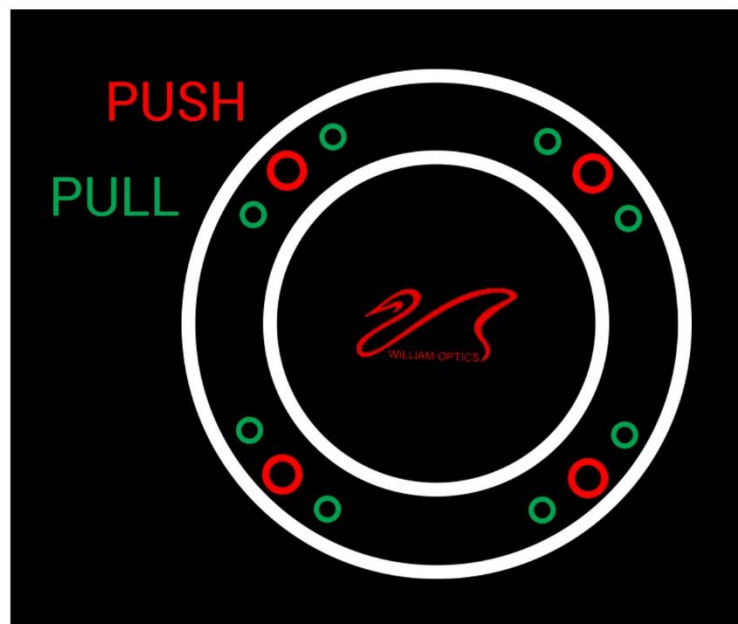

How to Install EAF

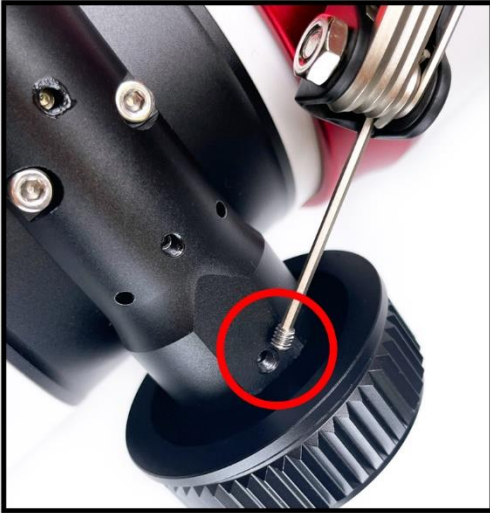

Step 1.

Remove the top screw with 2mm Allen key.

Step 2.

Release two inner knob screws.



Step 3.

Remove the knob.

How to Install EAF



Step 4.

Align the screw holes.

Step 5.

Lock two set screws on shaft.



Step 6.

Tighten both bracket screws.

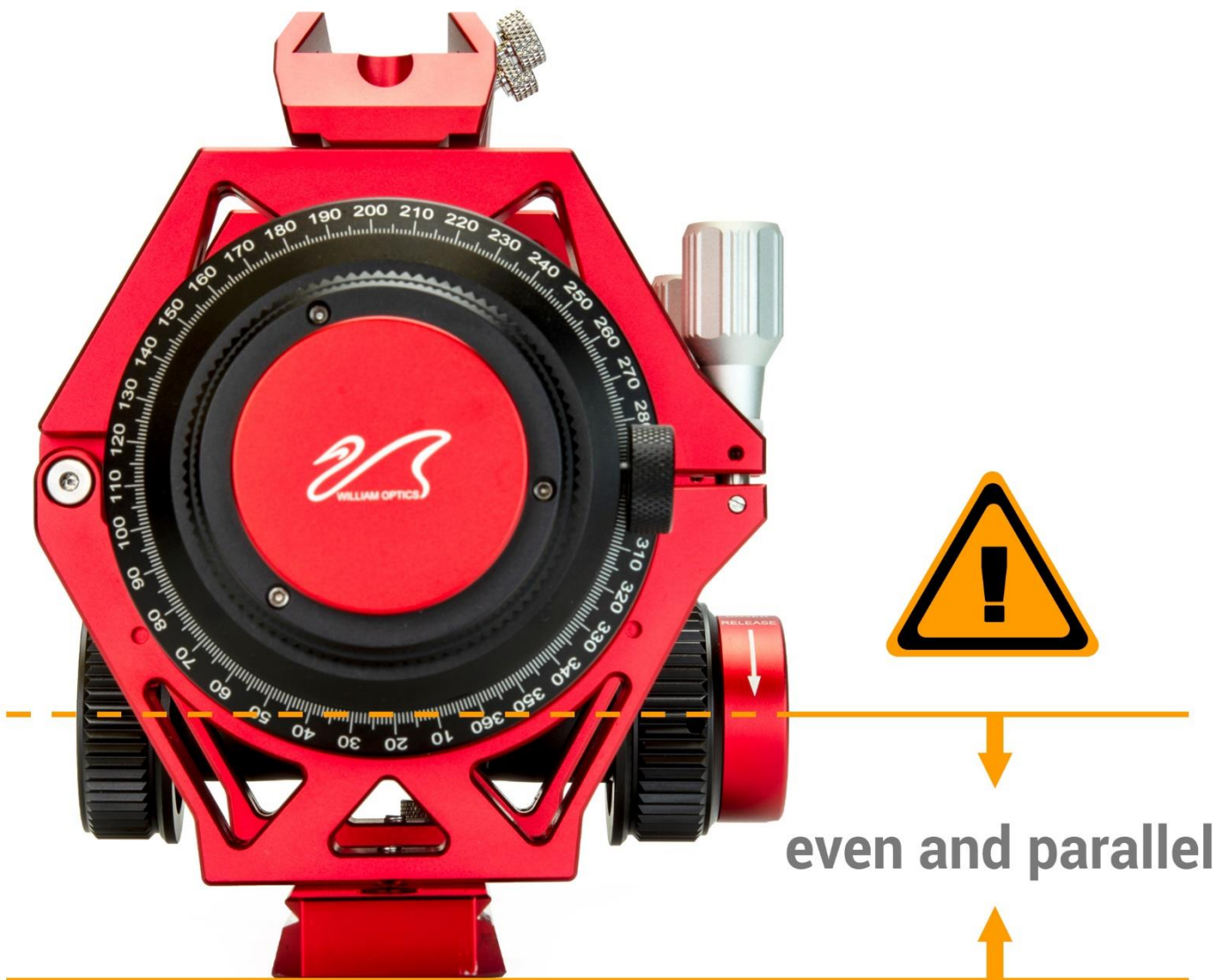
**NOTE:**

Ensure proper alignment by loosening the mounting rings and adjusting the telescope on the mount to guarantee that both knobs on either side of the focuser are **even and parallel** to the mount to prevent any interference with the knobs impacting the mount's saddle plate.

Cinematagraphy

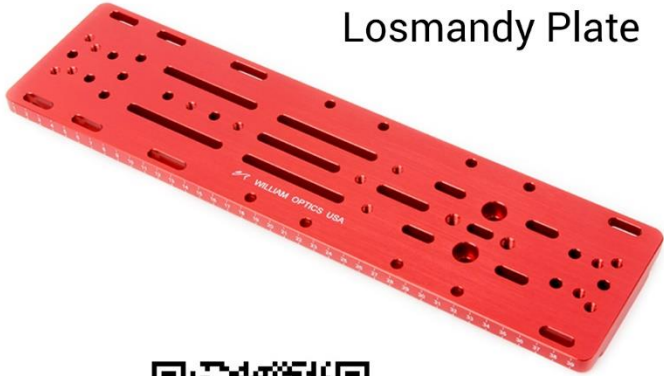

Losmandy Plate



Camera mount



Red Dot Sight



STC
 Astro-Multispectra Filter
 Astro Duo-Narrowband Filter



Astrophotography



M-G32PB-RD (optional)

