

AVALON
INSTRUMENTS

M-zero LHQ

SINGLE ARM MOUNT
(Made in Italy)



INSTRUCTION MANUAL

Version 1.0.1 July 2020

All the pictures and contents here included are property of AVALON INSTRUMENTS. The contents cannot be reproduced, published, copied or transmitted in any way, including the internet, without the written permission of AVALON INSTRUMENTS.

SAFETY STANDARDS AND WARNINGS

- Read the manual carefully before installing and using the mount.
- To make the document easier to read in the field, we recommend that you to copy all documentation files from the supplied USB drive to a smartphone or, even better, to a computer or tablet.
- Use the power cable supplied with the mount or else a 15V- 3A stabilized power supply as suggested in the manual.
- Make sure that the power cable is connected correctly and securely to the power socket.
- Do not bend, pull or press the cable as this may damage it.
- For any assistance or repairs, please contact only the manufacturer.
- Be sure to remove the power supply at the end of an observing or imaging session or before performing cleaning or maintenance. When removing from a power outlet, pull on the plug, not the cable.
- This mount is intended for use exclusively by adults. Do not allow it to be used by children under 12 or by people with impaired mental faculties.
- Operate the mount only as indicated in the manual.
- Modifying or altering the characteristics of the mount in any way will void the manufacturer's limited warranty.
- Never modify the tension of the belts (governed by a dedicated screw). These are set in the factory and any unauthorized change will void the manufacturer's limited warranty.
- After using the mount, avoid storing it in areas exposed to sunlight or in wet places.

IMPORTANT NOTE: DO NOT USE ANY KIND OF LUBRICANT, SPRY, LIQUID OR OIL ON THE BELT DRIVE SYSTEM!!!

Any use of lubricants will void the manufacturer's limited warranty.

Table of Contents

Summary.....	3
Technical Specifications.....	4
<i>Foreword</i>	5
Package Contents.....	5
1. Set the M-zero to Local Conditions.....	6
1.1 Tripod Mounting.....	6
1.2 Installing the Mount on the Tripod.....	7
1.3 Motor Cable Connections.....	7
1.4 Altitude Range Setting.....	8
1.5 Optical Tube Mounting.....	11
1.6 Choosing the Telescope.....	11
2. Telescope Balancing Operations.....	16
2.1 Declination Axis Balancing.....	16
2.2 Right Ascension Axis Balancing:.....	17
3. M-zero Alignment in Equatorial Mode.....	19
3.1 Latitude Regulation.....	19
3.2 Azimuth adjustment.....	20
3.3 Precise Polar Alignment.....	20
3.3.1 Polar Kit Installation.....	20
3.3.2. Polar alignment with a Skywatcher Polarscope.....	21
3.4 External Programs for Polar Position Finding.....	23
5. StarGO Installation and Use – Quick User Guides.....	29
APPENDIX A.....	30

Technical Specifications

Type	Equatorial Single-Arm mount with Fast-Reverse technology
Weight	10,1 kg (22,2 lbs.)
Load Capacity	For photographic use 8 kg (17.6 lbs.) – For visual use 10 kg (22,05 lbs.)
Transmission	Four-step reducer via pulley-toothed belt system on ball bearings, with no play in the axis
Construction material	Anodized aluminum, machined from single blocks with high precision CNC machines
Motion system	Pulleys made with special glass fiber polymer and high precision toothed belts
Polar finder	Celestron standard, others optional
Goto system	StarGO GOTO System
Counterweight bar	W= 16 mm (0.63 inch) / L = 85 mm (3.34 inches)
Counterweight	0.5 kg (1.1 lbs.)
Mounting Saddle	Vixen style
Warranty	2 years from the purchase date, extended to 5 years for the transmission system

Foreword

This manual describes the mounting, operation and correct setup of the M-zero LHQ, including the proper installation of a suitable optical tube.

Please read this manual carefully to guarantee that you can use the M-zero LHQ mount in complete safety and with the maximum satisfaction.

The instructions related to the StarGO control system and related software are described in separate Instruction Manuals:

Avalon Instruments - StarGO Control System

The instructions for using the M-zero LHQ with third party software are contained in the following Instruction Manual:



Avalon Instruments – Avalon StarGO: Third Party Software Use

Both the above manuals are included in **the flash drive supplied with the mount.**

The images published in the manual refer to the early versions of the mount and therefore small differences could exist between these illustrations and your own mount. Furthermore, the design and the configuration of the mount can be subject to modifications without prior notice, based on design decisions leading to continuous improvements and on the suggestions of mount owners.

1. Packing Content

Open the box and take out all the contents. Remove all the components from the small cardboard box and from the mount bag side pocket, and place them on a clean, flat surface.

Component List	
<p>Aluminum tripod with StarGO control box</p> <p>Motor's connecting cable</p> <p>Mount Head</p> <p>Mount Head and accessory transport bag</p> <p>Tripod transport bag.</p> <p>Counterweight rod</p> <p>StarGO Keypad</p> <p>0.5 kg Counterweight</p>	<p>Polar scope with support</p> <p>Power cable</p> <p>Warranty & Testing Certificates</p> <p>Declaration of Conformity</p> <p>Allen wrench</p> <p>USB flash drive with manuals and software</p> <p>Ra/Dec motor cables</p>
	

2 Mount Description

Strong, light and smart, with a total weight of 5.5 kg (12 lb), this very special version, being one of the few equatorial mount suitable for very low latitude areas till 0° in the market, it is the perfect instrument for the travelling astronomy, suitable for deep-sky imaging in the capacity range up to 10 kg (22 lb).

The following drawing show the M-zero mount dimensional characteristics. Dimensions are in mm.

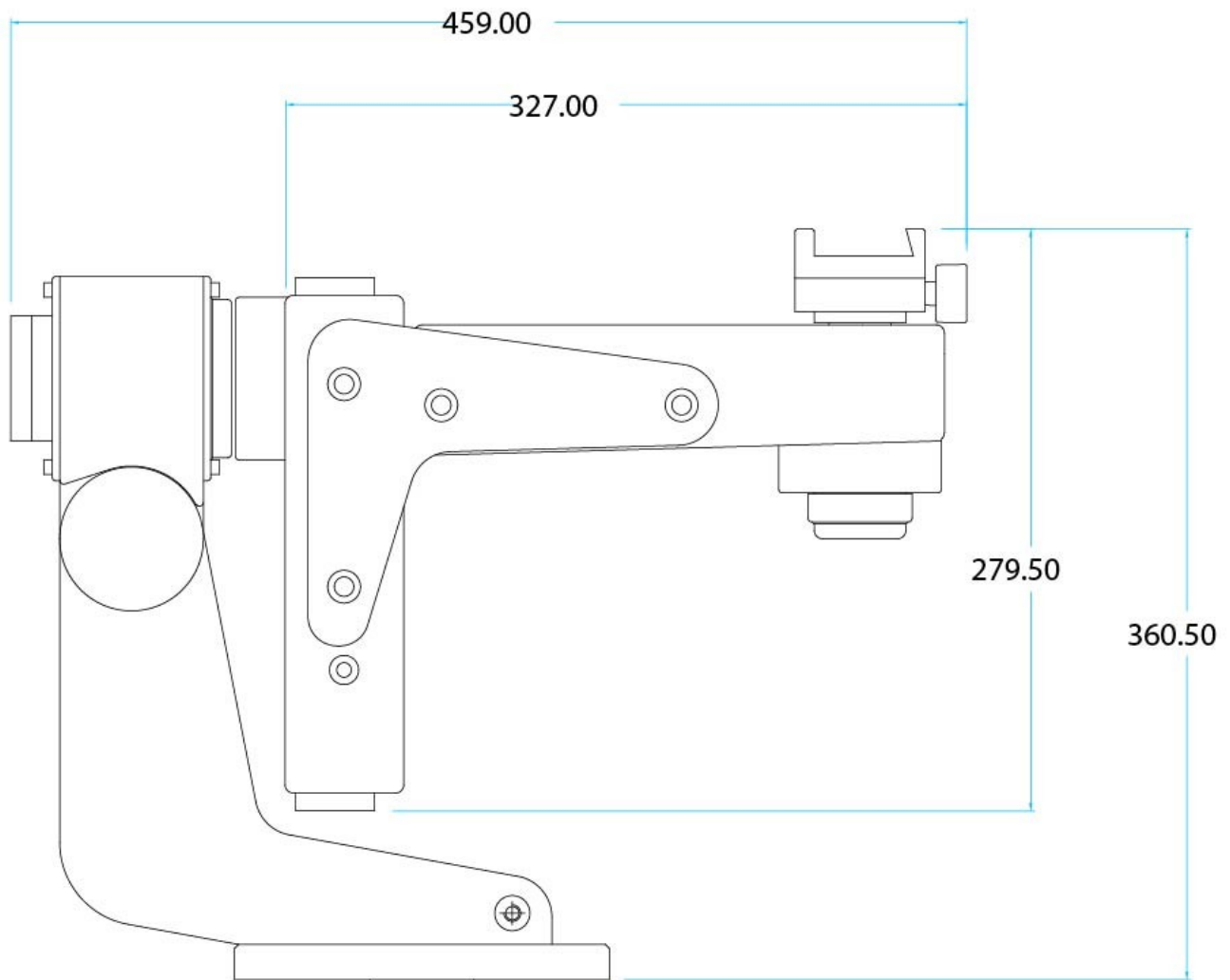

The M-zero LHQ design was developed on the basis of the M-zero standard version, making use of the same technical concepts:

- Fast Reverse technology
- Computer aided design (CAD)
- High quality manufacturing with digital control 5 axes CNC machines (CNC + CAM)
- Absolute quality materials: Anodized aluminium from milled mono-bloc, stainless steel components and screws, brass components, techno-polymers

The M-zero LHQ motion transmission technology is based on pulley-tooth belt without play, while its peculiar geometry makes easy the imaging at the meridian crossing regardless the typical problem affecting the classic German Equatorial Mounts, for both the risk of touching the tripod and the need of waiting for the object cross the meridian.

Moreover, considering that at the meridian the sky is less subject to light pollution and to atmospheric turbulence, the M-zero LHQ is the ideal tool to shoot deep-sky objects in their best conditions, close to the meridian, especially when the time is short and the sky is not so dark and clear.

The M-zero LHQ is mainly designed for astro-imaging with medium-short length tubes (such as SC-Maksutov, RC up to 6-8" aperture and 10 kg (22 lb) weight, according to the tube length). It is possible to use the M-zero LHQ even with refractors (400-500 mm), with a piggyback or parallel guidescope that can act also as an active counterweight.

The larger overhang of the single arm system will allow a greater pointing angle compared to the classic German Equatorial Mounts.

Another M-zero LHQ basic advantage is that it doesn't need heavy counterweights, nor the long bar. Its declination axis can be quickly balanced like in an equatorial mount, while, for the RA axis, it is possible to fix the arm on six possible positions and to make the fine balance using a very small counterweight.

The use of pulleys and toothed belts has allowed to obtain several advantages: a really steady motion without play (no backlash) and sudden peaks, factors of paramount relevance for long guided exposures and during high magnification visual observations. These features are of particular relevance especially for the declination axis motor that can now quickly reverse the motion without breaks to recover the plays: from here the mount name FAST REVERSE. The toothed belts used in the M-zero LHQ have the structure made of special material with steel strands to avoid any deformation, elongation and stress, much better than those used in the automotive engine distribution system (which are generally made of rubber with nylon strands). Considering that the service time for the automotive toothed belts is around 100.000 km (60.000 miles), assuming a medium regime of 2.000 rpm and thermal stress from 0 to 90°C (30 to 195 F) in a few minutes, we can think that the life cycle of the M-zero LHQ toothed belts will be extremely long! It is important to underline that in the gear-worm systems the motion transmission has only one tangent point of contact, any errors on each of the two components will, sooner or later, result into a tracking errors. On the contrary, in the pulley-toothed belt system, no direct contact occurs between the pulley and the motion is transmitted by the belt engaging from 50% to 90% of the girth surface. Consequently any error, eventually present, is averaged among the cogs, moreover soft, greatly reducing the tracking error.

No wearing effects since no relevant frictions occur. In fact, all the pulleys and the axes rotate on roller bearings, 13 for the RA axis and 13 for the DEC axis that allow to reduce the total friction almost to zero.

Another significant advantage of very low frictions is that the risks of motor slipping during GOTO operation is virtually null. On the contrary, it is well known the difficulty to regulate the coupling between gear and worm in the conventional mounts. If the coupling is tight the motors can stuck with consequent loss of the position, if the coupling is too loose the plays increase. On the other hands, the absence of significant play in the M-zero makes the initial calibration of guiding CCD quick and easy.



Since there are no gears, there is no need of periodical lubrication of the internal components and therefore the maintenance is extremely reduced and limited to the external cleaning.

3. Initial M-zero Setting

The M-zero LHQ can work within a latitude range from about 0° till 70°. Therefore the first operation to be performed is to set the latitude range and scale for the location where the mount will be used. The same operations must be performed when the mount is moved to a site with latitude outside the range originally set.



3.1 Altitude Range Setting

As previously stated, the M-zero LHQ can be used in a range of latitudes starting from 0° to 70°. The total amplitude of the operating range is about 70°, subdivided into 4 sub-intervals as follows:

First interval	0°	17°	
Second interval	17°	40°	
Third interval	30°	55°	

Fourth interval	55°	70°	
-----------------	-----	-----	---

The steps needed for establishing the correct latitude operating range are as follows:

Remove the screws (1) and (2) under the base	
Remove the screws numbered 1, 2, 3 and 4 from the side plate.	
Remove the plate to expose the brass plug.	

Unscrews the two screws and remove the brass latitude adjustment plug.



Place the brass latitude adjustment plug over the set of holes corresponding to the needed latitude range. The mount is shipped from the factory with the brass post in position $0^{\circ} - 17^{\circ}$.

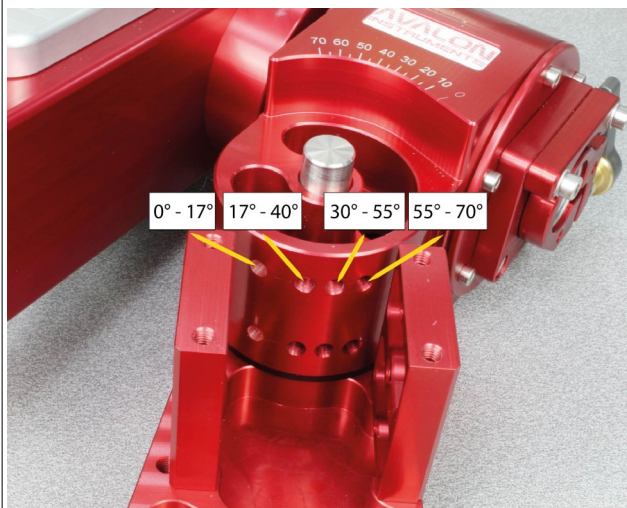

Re-attach the side plate using the four screws 1, 2, 3 and 4, previously removed.

Next, replace the two screws previously removed from under the mount



NOTE: The Alt/az configuration is not available in the M-zero LHQ mount.

3.2 Tripod Mounting

The operations described here require the M-zero LHQ to be firmly set on the T-Pod tripod. Therefore the first portion of this chapter will describe the operation needed to set up the tripod and install the mount on it.

For compact shipping, the T-Pod is packaged completely closed with the StarGO control box already mounted on one leg.

NOTE: If the StarGO control system will also be used for other purposes (i.e. to control mounts of other brands), it is possible to detach it from the tripod by unscrewing the two screws in the inner side of the tripod leg.

The tripod setup is very simple. The operations to perform are the following:

Place the T-Pod tripod head up with the legs on the ground. After loosening the knobs on the legs, adjust their length to the desired height.

- Pull the legs outward by extending the three tie-rods until they click in fully opened position as shown in this [video tutorial](#).
- Adjustment of the tripod height will depend on the type of telescope to be used with the mount. A Newtonian optical tube will require a minimum height because its eyepiece is placed at the distal end of the tube, close to eye height for a person of average stature. If the telescope is a refractor or a Schmidt-Cassegrain, the eyepiece is on the proximal end of the OTA and viewing will be more comfortable if the tripod is at its full height. Use the bubble level to adjust the length of each leg to put tripod head in an approximate horizontal position.
- Firmly tighten the knobs on each leg to set the leg lengths and the height of the tripod head.

3.3 Installing the M-Zero LHQ on the Tripod

Whatever type of tripod is used it must be mounted with the right orientation. This need that the brass contrast block which is installed over the tripod mounting plate, is oriented to the North with sufficient approximation. It is really easy to find the T-pod leg that should be pointed toward the North, it can be found by watching the T-pod leg that match with the yellow level bubble.

So the plate must be oriented with the brass plug matching with the north leg.

The M-zero LHQ comes with a plate for attaching the mount on the tripod, this plate, for safety shipping security reasons, it comes assembled on the mount base.

In order to attach the mount fixing plate on the T-pod, it is first required to remove the plate from the base of the mount, by unscrewing the three knobs.

Then it will be simply required to fix the plate on the T-pod, by using the two countersunk stainless screws provided, screwing it in the two M10 threaded holes circled

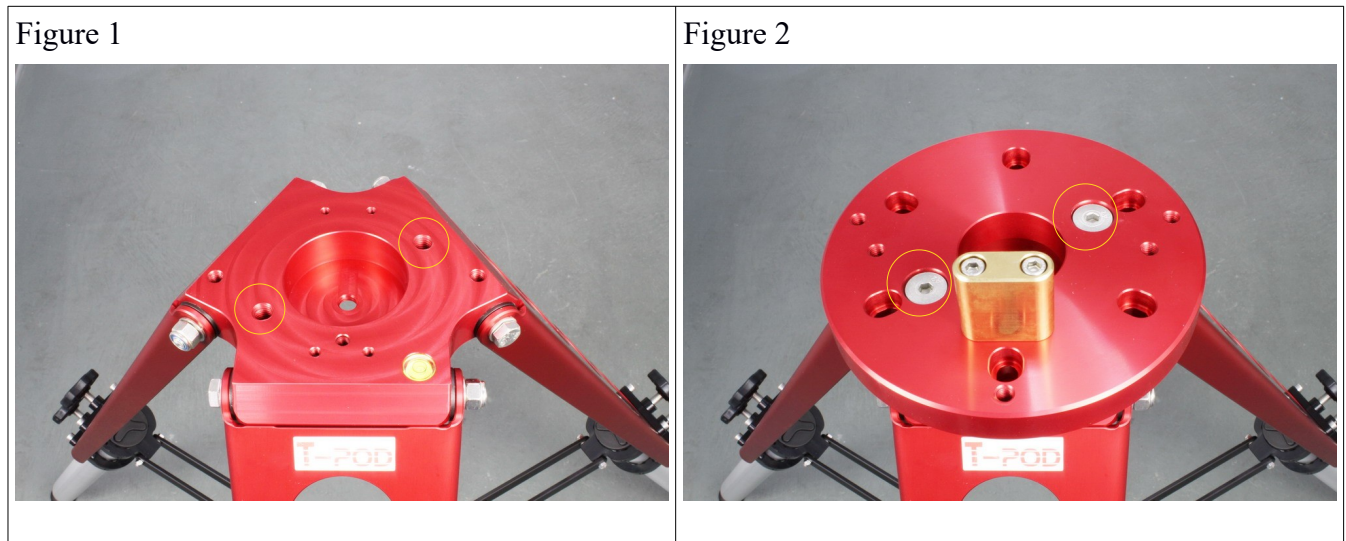

The following are the steps necessary to install the M-zero LHQ mount on a T-Pod tripod:

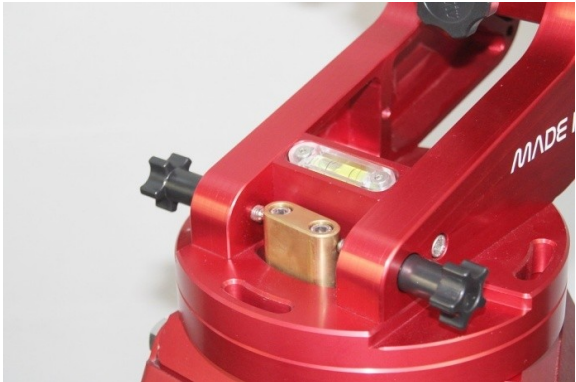
<p>Unscrew the azimuth adjustment knobs a few turns by rotating the azimuth adjustment knobs in opposite directions.</p>	
<p>Put the mount on the base plate so that the brass adjustment plug projecting up from the plate will fit in the proper space between the two azimuth adjustment screws.</p>	

Turn the azimuth regulation knobs until the screws touch the brass contrast plug



Tighten the three fixing screws equipped with plastic knobs in the three elongated lateral holes to keep the mount firmly in position.

Note: During the azimuth regulation for polar alignment, these three screws must be slightly loosened just enough to allow the mount to rotate on the base.

When alignment is achieved, tighten the screws again.



3.4 Motor Cable Connections

Once the mount has been installed on the tripod, it is necessary to connect the electrical cables from the StarGO to the motors and to the polar scope illuminator (if one is being used). The StarGO is provided with two RJ11 female connectors for DEC and RA motors and a pin jack socket for the polar scope illuminator.

The provided cable set is provided with two RJ11, 4 pin cables and one cable with pin jack connectors. The two RJ11 cables should be connected to the StarGO and to the mount DEC, RA motor connectors.

The third cable, with the pin-jack connector, must be connected to the illuminator.

Below are the operations to perform these connections:



1. Insert the RJ11 male connectors into the corresponding pin on the top of the StarGO box, as indicated in the picture below.



2. Pass the two motor cables through the central hole of the mount.
3. Connect the opposite ends of the RJ11 cables in their respective RA and DEC pin on the mount. Because the two cables have different lengths and colors and the two motor receptacles are at different distances, it is not possible to make mistakes. The longest cable goes to the RA motor and the shorter one goes to the DEC motor.
4. The pins of the third cable should be inserted in their corresponding receptacles of the StarGO and the Polar scope illuminator.

3.5 Optical Tube Mounting

The optical tube to mount on the M-zero must be provided with a male Vixen-type dovetail bar (standard width 50 mm) to fit the M-zero mounting saddle.



<ul style="list-style-type: none">Place the mount arm in a perfectly leveled position and firmly tighten the RA axis clutch knob.	
<ul style="list-style-type: none">Turn the DEC axis clutch knob (#1 in the right picture) and rotate the female dovetail plate until it is parallel to the mount arm.Firmly lock both axis clutch knobs.Loosen the dovetail saddle plate lock using the knob #2 in the picture at right.	
<ul style="list-style-type: none">Insert the dovetail bar of the optical tube in the saddle and, while safely holding the optical tube with one hand, firmly tighten the knob #2 with the other hand. The assistance of another person could be helpful in performing this operation, especially if the tube is particularly heavy and/or oversized.	
<p>Note: Before taking your hands off the tube, make certain that the OTA is firmly seated in the mounting saddle with no wobbling.</p>	

3.6 Choosing the Telescope

The M-zero LHQ is an extremely versatile mount and can carry several varieties of telescopes, it can be set for continuous operation without the need to perform the “meridian flip”. This can be facilitated by the appropriate choice of a telescope.

Another benefit of the M-zero is its ability to mount two parallel telescopes. This feature offers a wide range of advantages, such as simultaneous observation with different filters or auto-guiding.

A simple optional accessory is required to mount a parallel telescope.

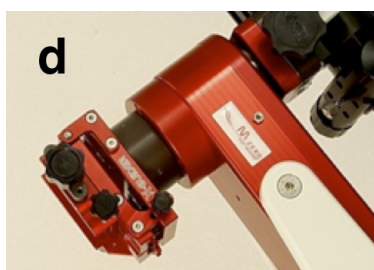

 <p>a</p>	<p>In order to install this accessory it is necessary to remove the plastic plug that has the Avalon logo (fig. a). This removal enables the mounting flange (fig. b) to be inserted.</p>	 <p>b</p>
 <p>c</p>	<p>This flange holds the Dual-DEC accessory for mounting the Secondary Vixen dovetail saddle (fig. c) or the X-Guider (fig. d).</p>	 <p>d</p>

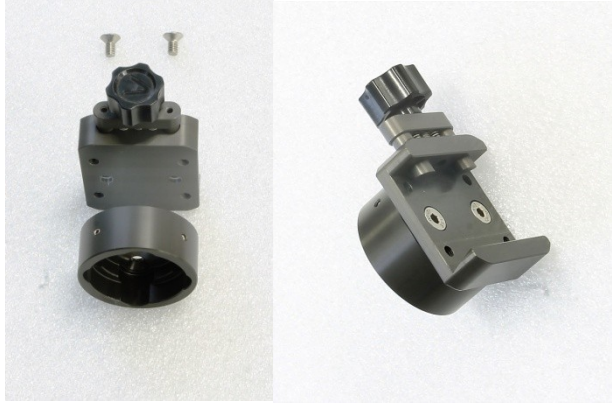
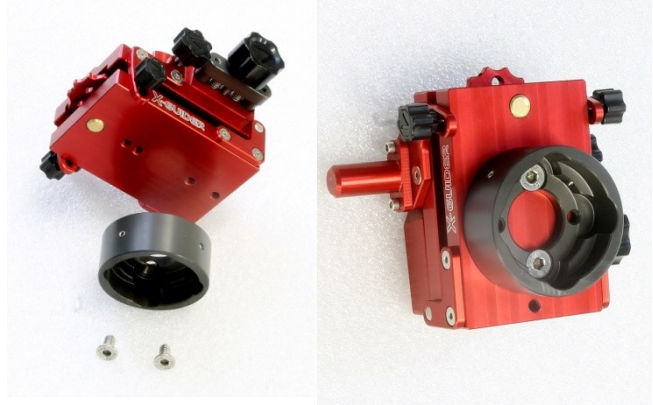

The X-Guider is moveable in two directions, which allows perfect alignment of two telescopes. When used with a second telescope for auto-guiding, it also allows the slight misalignment required to search for a suitable guide star.

The figures below show the optional kit components described above.

	
<p>Secondary Vixen Saddle kit components</p>	<p>Avalon X-Guider kit components</p>

The following table illustrates the M-zero mount possible configurations (operating mode and telescope type):

Telescope type	Picture	Note
Any type of optical tube		<p>This setup allows the use of any telescope type (<u>within the allowable weight limits</u>). Medium length refractors are possible because the arm position permits the telescope rotation without obstacles.</p> <p>The counterweight being used is 0.5 kg.</p>
Optical tubes up to 8” RCs and SCs and Newtonians up to 6”.		<p>In this setup the L shape brackets have been mounted in reversed position to allow the repositioning of the arm to a more extended position. As seen in the illustration, it is possible to balance an 8” SC with a counterweight of only 0,5 kg.</p>

<p>Two parallel tubes: An 8" f/10 SC weighting about 7 kg and a 70 mm secondary refractor weighting about 3 kg.</p>		<p>In this setup a secondary optical is mounted on the optional X-Guider, permitting precise alignment of the two optics.</p>
<p>DSLR Camera</p>		<p>A DSLR camera can be installed on the M-zero mount, allowing it to perform wide and extra-wide field imaging. It can be mounted as a stand-alone or in parallel with a telescope. In this case the telescope can be used as a guide-scope for longer exposures.</p> <p>With this setup a counterweight is not necessary</p>

4 Telescope Balancing Operations.

To correctly balance the telescope it must be free to move manually around both rotational axes.

A significantly unbalanced mount can cause the telescope to drop quickly with potential damage to the tube or to the mount itself. To prevent this from happening when using the mount in Equatorial mode, be sure to hold onto the tube with the hands before loosening the clutch knobs if the telescope has not been balanced, especially in the DEC axis.

To guarantee correct and reliable mount tracking it is necessary to balance the telescope in both rotational axes. Even if the telescope is not intended to track in Declination, the optical tube must still be balanced in this axis to avoid sudden movements when the DEC clutch is loosened. This precaution also helps to limit vibrations and to provide immediate response during auto-guided photographic sessions.

4.1 Declination Axis Balancing

With the M-zero LHQ mount it is better to balance the DEC axis first because the RA axis will already be almost balanced.

1. Put the telescope in a horizontal position.
2. Loosen the DEC axis clutch knob and allow the tube to move – **GRADUALLY** – to verify in which direction it tends to move.
3. Slightly loosen the knob on the mounting saddle that keeps the dovetail bar and the telescope fixed to the mount. Next slide the tube forward or backward and tighten the saddle knob. Repeat this action until the mount stays in the same horizontal position even with the DEC axis clutch completely loosened. This stability indicates that the telescope is balanced in the DEC axis.
4. Tighten the mounting saddle knob and the DEC clutch knobs to lock the telescope in the balanced position.
5. **DO NOT** let go of the tube until the mounting saddle knob and DEC clutch knobs are firmly tightened.

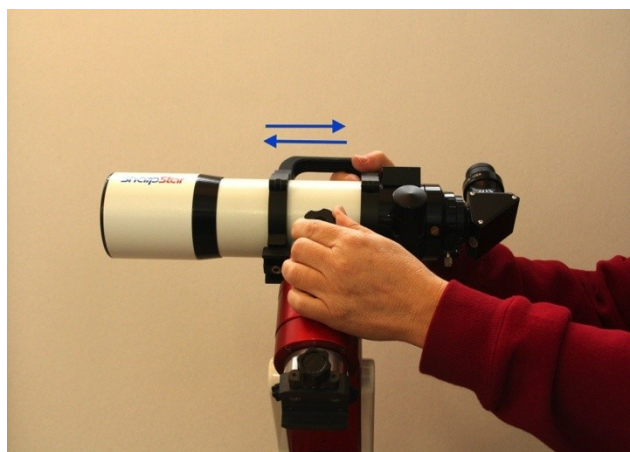

4.2 Right Ascension Axis Balancing:

The M-zero LHQ mount has a system of RA axis balancing which is different from that of German Equatorial Mounts but still very simple.

The balancing is performed in two phases, approximate and precise. The approximate balancing, which is performed less frequently, requires some working on the mount and it is better to carry it out at home. The precise balancing can be performed in the field.

Approximate Balancing

To perform an approximate balancing of the mount in the RA axis:

1. The optical tube must first be removed from the mount.
2. Unscrew and remove the Allen screws (1a) and (1b) on both the L shaped lateral brackets and set them aside. Removal of the screws leaves the DEC arm completely free from the rest of the mount and therefore it is necessary to hold onto the arm by hand during removal of the second bracket.

The illustration at right shows the holes drilled in the RA arm to position the DEC arm at different distances from the RA rotational axis. These changes in the DEC arm position allow a rough approximation of the balancing of the whole system. The picture right shows the two arms without the bracket for purposes of clarity

The position of the hole pair (A-a) corresponds to the minimum distance from the axis and is used for lighter telescopes. The pair (C-c) corresponds to the maximum distance and is used for heavier telescopes.

Choose the hole pairing that is most suitable for the telescope you intend to mount. Align the holes in the brackets you previously removed with the desired pair of holes in the RA arm. Use the Allen screws you also removed previously to attach the
Firmly tighten all bracket screws to guarantee maximum rigidity of the mount during operation.



Precise balancing



Assemble the counterweight shaft on the counterweight fixing plate on the bottom of the DEC arm by screwing the small screw in one of the three threaded holes available. There are five available position to fix the counterweight shaft, depending on the setup. It is also possible to assemble two counterweight shafts.



For the single counterweight shaft configuration, the most common position is the number 3.

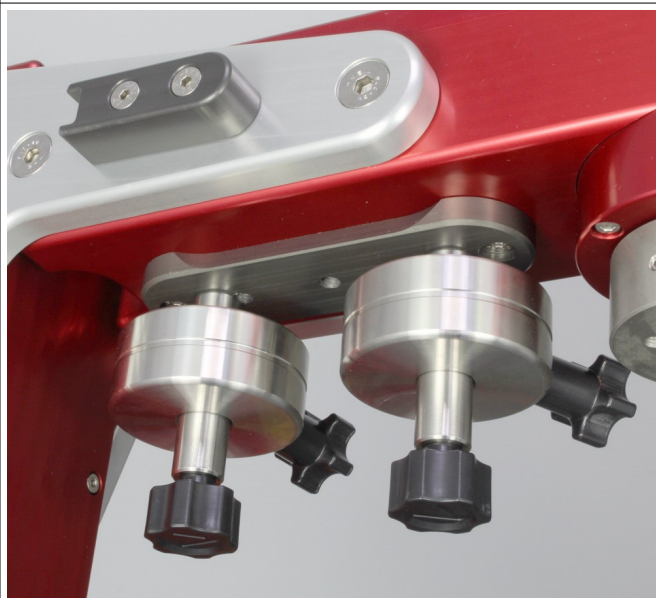

By using simultaneously the position 1 and the position 5, with an **extra optional counterweight shaft** and with an **extra optional counterweight**, a double counterweight shaft configuration is also available. This configuration it is recommended for heavier setup.



The precise balancing is carried out by loosening the RA clutch. The equilibrium point is reached by moving the counterweight on the counterweight shaft. It should not require much movement, but longer counterweight shafts and additional counterweights are available in case more weight is needed to achieve proper balance. When balance is established, tighten the counterweight knob and the RA clutch knob.

NOTE: Other mounts, based on geared wheel and worm drive systems, must be slightly unbalanced in the direction of celestial movement to obtain precise tracking. Such mounts may require occasional re-balancing by moving the counterweight. In contrast, the M-zero LHQ mount is well balanced in every position to guarantee the absence of backlash, hysteresis and pendulum effects around the meridian. This difference proves to be a significant advantage. Due to the M-zero's toothed belt transmission system, once balanced, it is no longer necessary to change the weight position. This is a valuable feature for long term Astrophotography around the meridian and is essential for the remote use of the mount.

5. M-zero LHQ Alignment.

The mount alignment consists of adjusting the mount's altitude and latitude such that its declination axis points exactly to the celestial North Pole.

To perform such an adjustment, the actions necessary to set the altitude and the latitude of the mount to those of the observation site are described here. For more precise alignment, the polar-scope provided with the mount (or a different type of optional polar-scope) is used.

5.1 Precise Latitude Adjustment

After leveling the mount base using built-in the bubble level, the next step in this process consists of approximately setting the polar axis at an angle equivalent to the latitude of the observation site. For example Rome is about 42° North, Milan and Venice 45° North and Palermo 38° North. Refer to the latitude scale on the side of the mount.



The latitude adjustment must be performed using both hands to turn the two latitude adjustment knobs in conjunction with each other. While one hand is tightening the front knob, the other hand should be loosening the rear knob and vice-versa. To increase the latitude (i.e. raise the polar axis), the rear knob must be turned in the clockwise direction while the front one is turned in the counterclockwise Direction. To lower the axis, the opposite actions are performed.

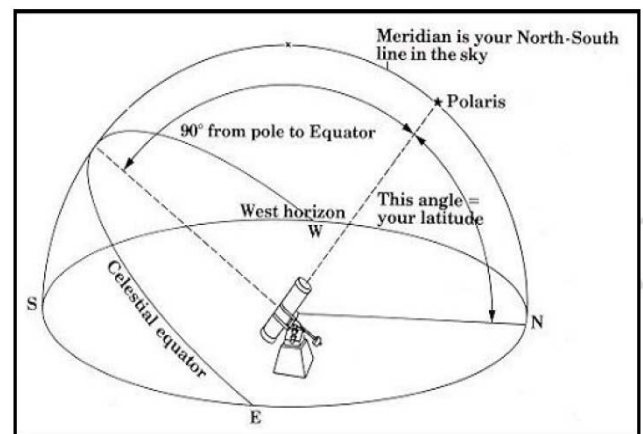

NOTE: It is generally better to perform the fine latitude operations against the force of gravity, that is, by raising the mount.

5.2 Azimuth adjustment

The azimuth regulation is performed in a similar manner, using both hands to turn the other two adjustment knobs in opposite directions simultaneously. When a knob is rotated in one direction the other is rotated in the opposite direction. Turn them so that the screws attached to the knobs press against the brass adjustment post and move the mount to the right or left by a small amount. The azimuth adjustment knobs are those positioned on both sides of the mount as seen in the picture on the right.



Alt-Az Polar Alignment

The following table shows the amount of rotation for precise Alt-Az alignment of the Avalon Linear, M-Uno, M-Zero and M-Zero LHQ mounts. Each full turn of the Altitude and Azimuth knobs moves the mount in the exact amount, shown in arc-minutes, for the particular mounts listed.

Mount	Linear		M-uno		M-zero	
	ALT	AZ	ALT	AZ	ALT	AZ
Arc minutes per knob turn	91,2	79,2	78,74	79,2	61,8	110,4

5.3 M-zero Polar Alignment

5.3.1 Polar Kit Installation

The precise polar alignment of the M-zero LHQ mount is performed with the polar scope installed externally on the mount.

The standard kit for the precise polar alignment consists of the following components:

1. Celestron Polarfinder and Polarfinder adapter with the fixing knob.
2. Polarfinder adapter fixing dowel already assembled on the M-zero LHQ lateral bracket
3. External illuminator cap with a red LED and connection cable to the StarGO.

The polarscope comes with the mount already assembled with it's own adapter. To fix the Polarscope on the mount lateral bracket dowel, place the Polarscope adapter male dovetail on the female dowel dovetail, and tight the fixing knob.



3.2. Polar alignment with the provided Polarscope

The M-zero LHQ comes provided with a Celestron Polarscope. The picture below shows the polarscope reticle. For an accurate polar alignment with Avalon Instruments mounts it doesn't matter for the constellation position. The reference point it will be the small circle that represent the Polaris position or a defined degree in the graduated circle.

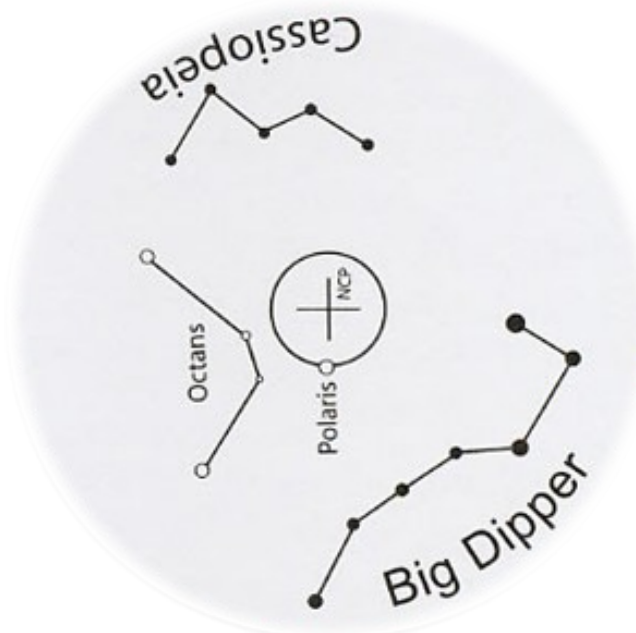

Celestron polarscope reticle

It is well known that the Polaris is at about 40 arcmin distance from the Celestial Pole and therefore it orbits around the pole at that distance every about 24 hours. The cross in the reticle center indicates the position of the Pole. The circle around it represents the orbit of Polaris. The small circle on the orbit represents the variable Polaris position. The problem here is to position the smaller circle at the correct Polaris angle as it is seen from the observation site at the observation date and time. Years ago this position was obtained using several types of circular dials and performing few calculations.

Currently the most common method to get the exact position of Polaris is using one of several available computer programs or, better, mobile device applications. These programs provide the position of Polaris both visually and in the hourly format as described in section 5.3.3. Once the Polaris position has been determined in terms of hour angle, the polar scope should be rotated to bring the small circle in that position. With this type of reticle this operation is approximate, but is accurate enough and is satisfactory for most applications.

The small circle representing Polaris must be put in the annulus corresponding with that hour, starting with the 0 of the annulus in the upper position.

Once the correct position of the small Polaris circle has been established, the following operations should be performed:

Once the correct position of the small Polaris circle has been established, the following operations should be performed:

1. Slightly loosen the knob that keeps the mount fixed to the tripod base to allow its Azimuth rotation, while still keeping it safely on the tripod.
2. Slightly loosen the black knurled side knobs to allow the Latitude (altitude) movement.
3. Once you are confident that the polar scope is correctly oriented, use small movements of the Azimuth and Altitude adjustment knobs to place Polaris exactly in the center of the classical reticle's corresponding small circle in or in the defined hour position for the newer type reticle.
4. When finished, firmly re-tighten the Altitude and Azimuth knobs as well as those fixing the mount to the tripod. The mount is now aligned to the celestial North Pole.

In case of use of the new reticle (on the right figure) the only difference is that, being missing the small circle correspondent to the Polaris, the star must be brought to the position in the graduated circle defined by the specific application.

5.3.4 External Programs for Finding Polar Position

Many apps exist to determine the position of Polaris compared to the exact position of the celestial North Pole. Only two of these apps are discussed in this section. However the same concepts described here are applicable to all other existing apps.

“Polar Scope Align” is an app which runs on iOS smart devices. This program uses the device’s internal GPS to evaluate the geographical coordinates of the observation site to calculate the exact position of Polaris around the North Celestial Pole. It also provides some additional information that can be useful for correct setup of the telescope.

With his application it is possible to interchange the kinds of reticles to be used for the polar alignment, including the Skywatcher classic reticle, as well as the newer version and the Losmandy type.

The position of Polaris is represented by a small yellow circle on a larger circular reticulum. To effectively use this app with the older Skywatcher reticle or with the newer type, it is necessary to take note of the hour angle where Polaris is located and rotate the Polarscope reticle to the same angle, bringing the Polaris circle around to the correct position. You will observe that the reticle reproduces exactly the same optical inversion caused by the Polar-scope optics.

The following figures illustrate the screenshot of the Polar Scope Align app with the classic and new polar-scope reticles.

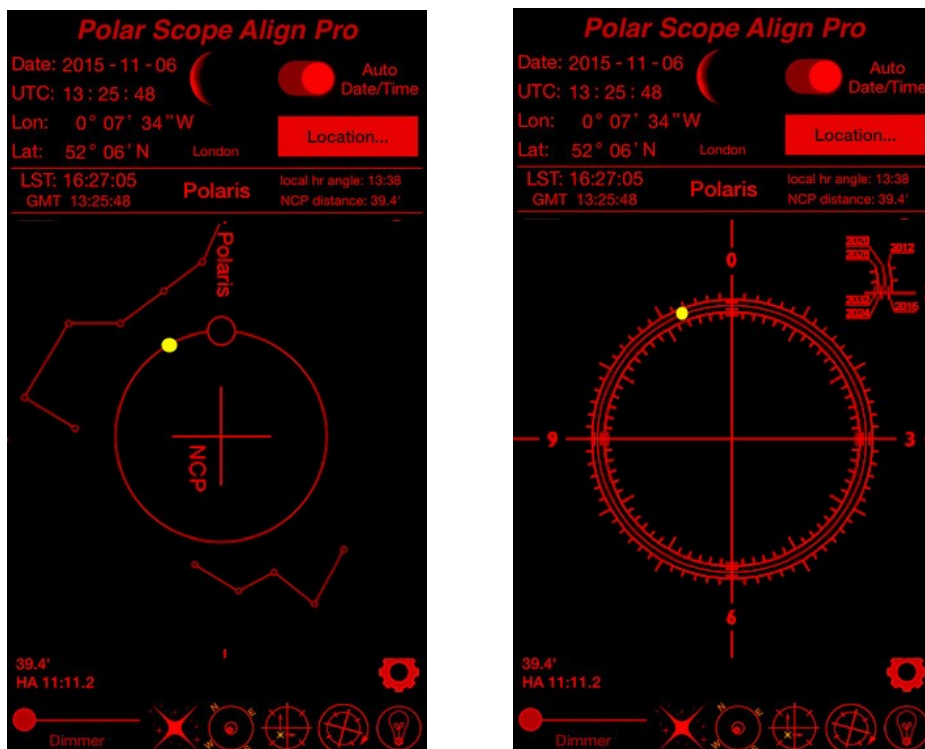

The “Polar Finder” is a similar application available for Android smartphones and tablets of

different brands. This app and others that can be downloaded are able to accurately reproduce the reticle of the M-zero’s polar-scope as well as the reticle of the optional Losmandy polar-scope. The “Polar Finder” app is flexible and able to replicate a variety of the more common reticles suitable for use in the Northern or Southern Hemisphere, including the types of reticles available for the M-zero.

The following figures illustrate the Android “Polar Finder” app replicating M-zero and Losmandy polar-scope reticles.

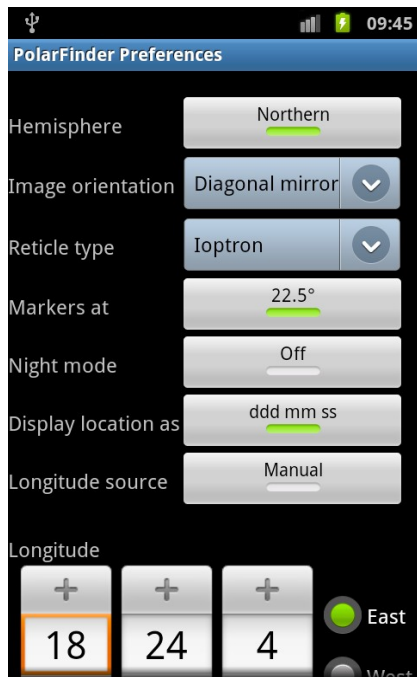

Polar Finder Preferences

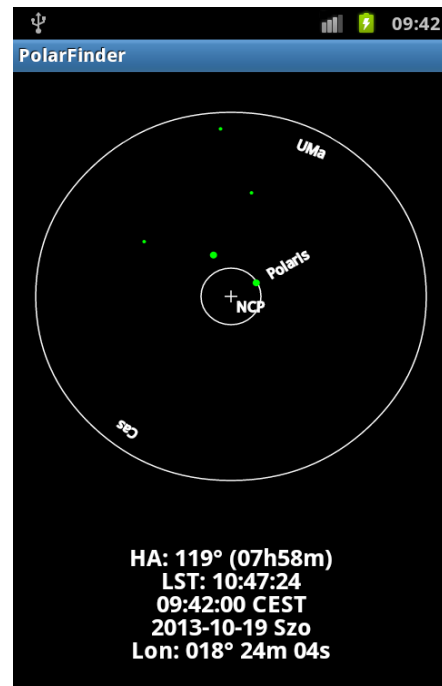

Classical Reticle Layout

The “Polar Finder” app also takes the observation site’s geographical coordinates from the Android device’s internal GPS if available. If the device has no internal GPS the geographical coordinates of the site must be manually entered. The additional features of the Android app are similar to those provided by the iOS app but the reticles more closely resemble those available for the M-zero.

5.3.4 More modern and precise approaches to Polar Alignment

In the last years a special CCD camera has been commercialised, called Polemaster, to perform a very precise polar alignment using an expressly developed software (requiring therefore a Windows or Mac PC that, however should be available for the successive astrophotography session).

That CCD must be firmly installed on the mount keeping a good parallelism with the polar axis of the mount itself.

The Avalon Instruments has also developed a special software that, among several others functions, has a tool to perform a precise polar alignment using the “plate solving” algorithm which is shipped together with all other software for the StarGO included in the supplied USB pendrive. Detailed description of this tool is done in the StarGO User Guide.

6. M-zero LHQ Use for “Time Lapse” Photography

The Dual Dec accessory enables the M-zero to mount a small auxiliary telescope or a photographic camera in parallel with the main telescope. This feature makes it more convenient to use the mount for long exposure pictures with the auxiliary telescope serving as a guidescope. This feature offers superior rigidity compared to systems where the guidescope or camera is mounted in “piggyback” fashion over the main telescope. Alternatively, a DSLR camera can be directly mounted in the place of the auxiliary tube. In the illustration shown below the camera has a lens suitable for wide field or “Time Lapse” photographs. The StarGO control system is designed to directly control a DSLR camera, making that type of photography much easier.

This section describes the mounting of the camera on the M-zero and its electrical connection to the StarGo. More detailed information on the use of a DSLR with the StarGO is provided in the StarGo manual.

Mechanical installation

Install the Dual Dec with the dovetail female bar (1) on the opposite site of the main telescope.

Attach a male dovetail Vixen type bar (3) under the DSLR (2) camera using a standard ¼-20 photographic tripod screw.

Insert the male dovetail bar inside the female one and firmly tighten the Knob (4)

The electrical connection of the DSLR to the StarGO panel is performed as follows, making certain that both devices are switched off.

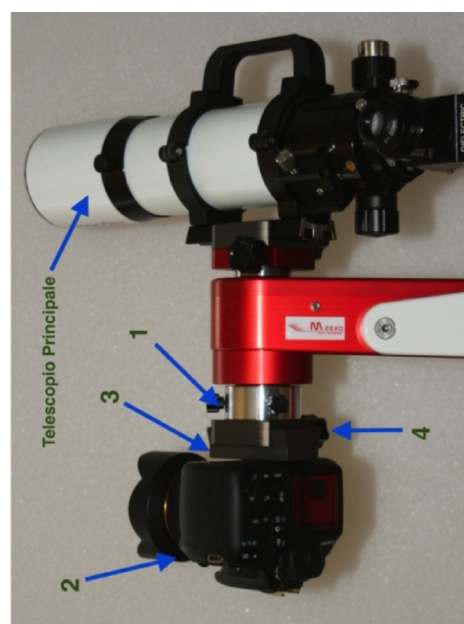

On the camera:

Lift the rubber tab (1) on the side of the DSLR to expose the input receptacles and insert the cable connector (2) into the receptacle (3) for the external command of the camera. Note that the actual connector (2) could be different from that shown in the figure. The camera should come equipped with the proper cable and connector.



On the StarGO side:

Insert the jack at the other end of the cable into the input (2) labeled DSLR on the StarGO panel.

Switch on both the camera and the StarGO: The DSLR is now ready to be controlled by the StarGO

To upload pictures to the PC it will be necessary to use a USB cable connecting the camera to the computer.

