

10 MICRON  
astro•technology

by COMEC-TECHNOLOGY

GM 1000

HPS



## 10MICRON: NO COMPROMISES

*The development of 10micron products is aimed to provide both the best performances and the maximum ease of use.*

The availability on the market of more and more advanced and flexible astronomical imaging systems opens new windows on the sky: today, ultra-high definition and ultra-high speed imaging is within the amateur's reach, way more than what was predictable ten years ago. 10micron's products evolved at the same pace, in terms of tracking and pointing accuracy and speed. The HPS series mounts are now at the peak of this process.

Every observer knows that when you are under the sky you have little time and each set up operation comes with the risk of compromising the night. Having excellent performance on paper means nothing if you need many complex set up operations before reaching it.

This is the reason 10micron mounts are designed around the user's needs, and not to enforce the mount's way of operation on them.

Now 10micron mounts are used in the open field as well as in remotized sites, in educational observatories as well in the extreme climates of northern Canada and Atacama desert.

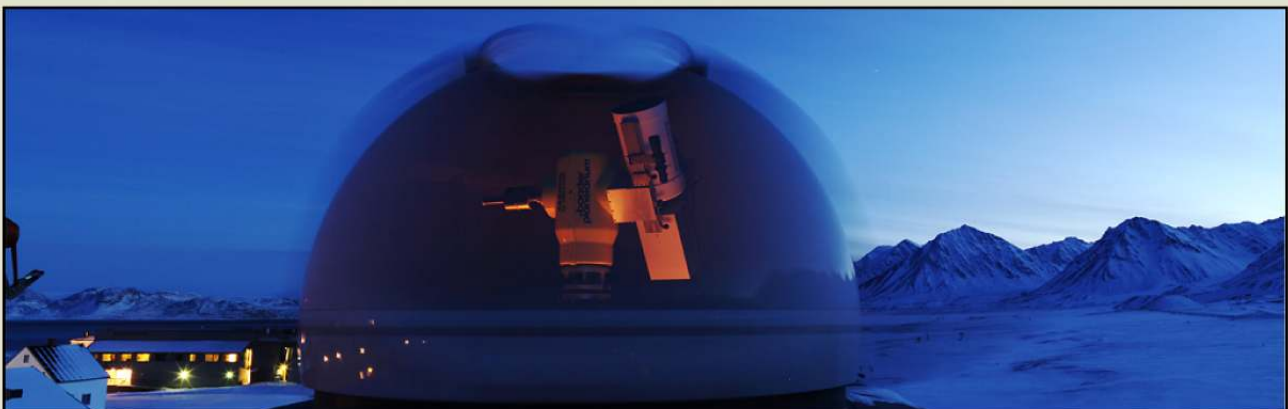



## TEN YEARS OF HISTORY

*The experience of ten years in astronomical manufacturing.*

The 10micron mount line was born in 2000 with the aim of providing high standard quality products: Equatorial mounts, altazimuth mounts and tripods always with the best performance.

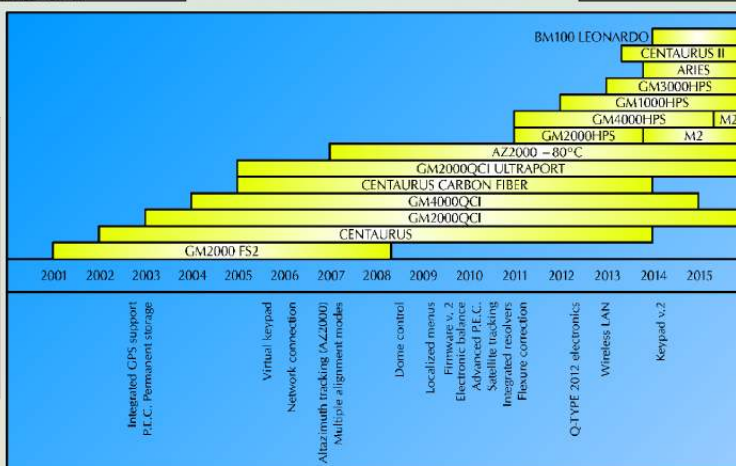

*The 10micron product range.*

From the traditional german equatorial mounts GM2000 and GM4000, now also in the HPS version, to the special application AZ2000 altazimuth mount, and the new GM1000HPS and GM3000HPS mounts, the 10micron product range is dedicated to the most demanding observer.

## PUSHING THE PERFORMANCE ENVELOPE

*The effort to improve performances doesn't know a break.*

Two are the main numbers defining the performance of an astronomical mount: the tracking accuracy and the maximum slew speed. The constant technological evolution allows for improving these numbers continuously. From the first GM2000 mounts with stepper motors up to the new GM3000HPS, the tracking accuracy has been improved by an order of magnitude and the pointing speed has been improved by a factor of three.

An high pointing speed is required for many astronomical applications. Searching for supernovae, asteroids or exoplanets, where images of a large number of different objects are required in the minimum time, as well as tracking artificial satellites.

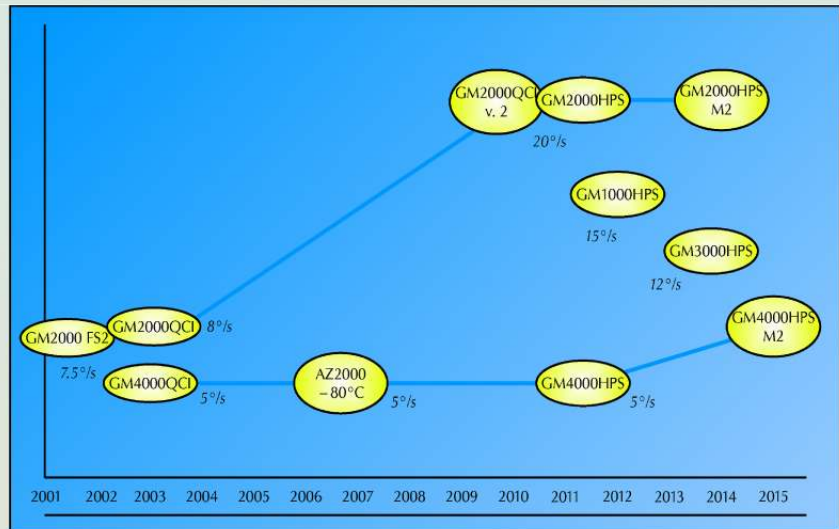

*Pointing speed of 10micron mounts.*

An excellent tracking accuracy is required instead for high-resolution deep-sky imaging, in order to simplify or completely get rid of complex autoguiding systems, which can be source of errors or breakdowns.

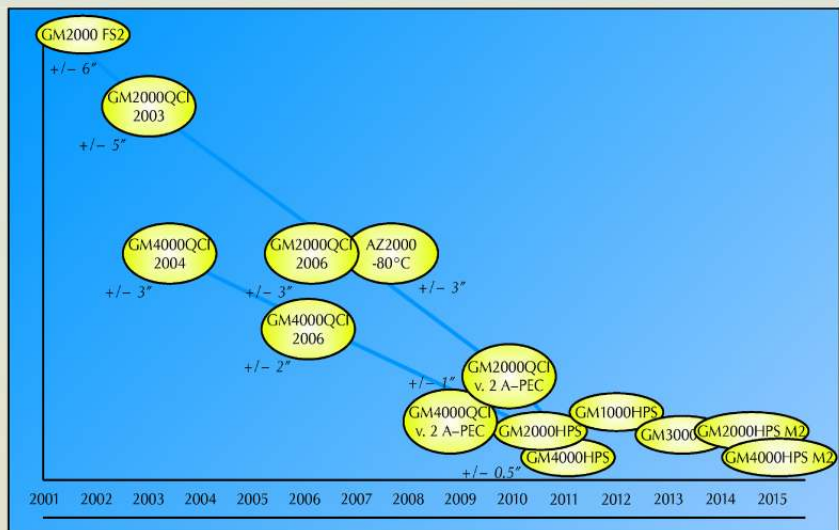

*Tracking accuracy of 10micron mounts.*



## THE HPS TECHNOLOGY

*HPS stands for High Precision and Speed, representing the essence of the new 10micron mounts. High precision, thanks to an innovative and exclusive absolute encoder paired with the 10micron manufacturing. High speed, thanks to high performance electronics and AC servo motors.*

The HPS series mounts are equipped with a pair of absolute encoders with ultra-high resolution, directly mounted on the right ascension and declination axes.

This technology has been used already in the professional observatories, where the high cost and complexity are not an issue. Measuring directly the rotation angles of the axes allows to compensate the large part of the mechanical errors, such as periodic errors and transmission backlash. However, this requires systems with very high resolution.

In the past few years this technology is being found also in amateur astronomers' instruments, often paired with the use of *direct drive* technology, where motors are mounted directly on the mount's axes, without any mechanical reduction gearing.

While having some advantages, using a *direct drive* system implies also some drawbacks such as having axes less robust to external stresses like wind and greater power needs. For this reason, 10micron mounts continue to feature the traditional worm – wormwheel transmission.

The absolute encoders used in the HPS mounts have been specifically designed for this application. Beyond a resolution of the order of a tenth of an arcsecond, in this way we have also removed any need for homing or position-saving procedures.

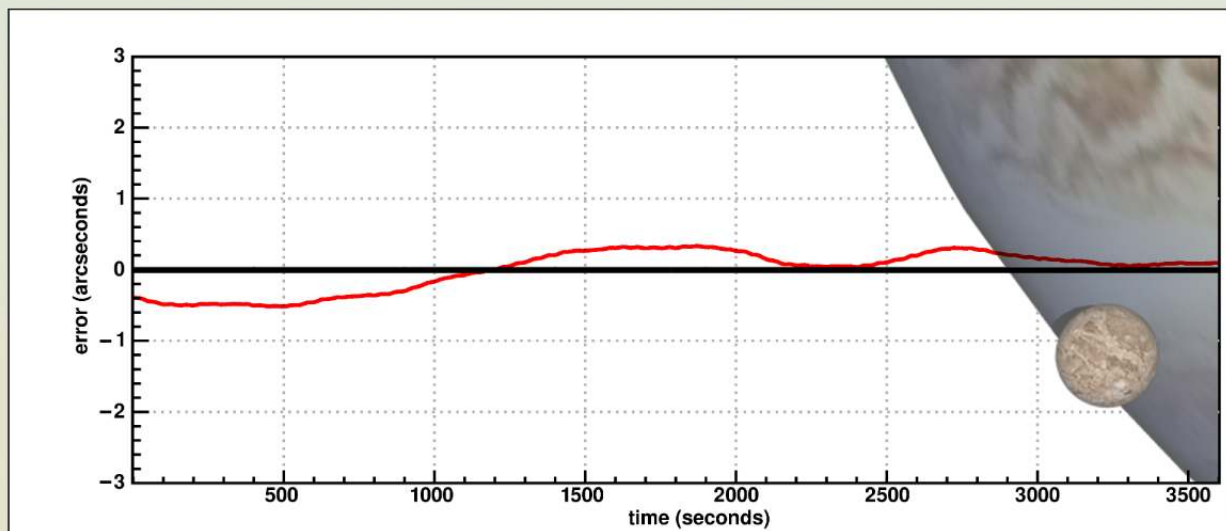

*Tracking error profile measured with an encoder coupled to the r.a. axis. Jupiter and Ganymede are shown as they appear from Earth, at the same scale.*

## GM1000HPS

*Evolving perfection.*

The GM1000HPS mount is built for the demanding observer using photographic instruments up to a weight of 25kg – 55 lbs (counterweights not included).

Movements are driven by two AC servo motors, with timing belt reduction having zero-backlash. Both axes feature a classic worm – wormwheel pairing. The wormwheels are made of bronze (B14), with a diameter of 125mm and 250 teeth, while the worms are built of alloy steel with a diameter of 20mm. The axes themselves are made of 30mm diameter alloy steel, for the maximum rigidity.

The double dovetail mounting plate guarantees the maximum compatibility with many telescope manufacturers.







The connections of the control box.

The electronics is housed in an independent control box, easily removable. The connections of motors, encoders and hand pad feature security lock screws.

The mount can be controlled using the included hand pad, without connecting an external PC.

The keypad is built in order to maintain the maximum readability in all lighting conditions. Both the display and the ergonomic keys, allowing for the use of gloves, feature a red backlight. An heater keeps the display warm for usage below freezing temperatures.

The mount can be controlled using the most common software packages by connecting it to a PC with the RS-232 serial port or the Ethernet connection, via the proprietary 10micron ASCOM driver or the Meade compatible command protocol. Furthermore, a dedicated software (also included with the mount) can be used to create a "virtual hand pad" replicating exactly the functions of the physical hand pad. The RS-232 port can also be used to control an external dome. This flexibility makes the GM1000HPS an ideal mount for observatories and remotized observing sites.

The object database contains many star catalogs and deep-sky objects up to the 16<sup>th</sup> magnitude. Solar system objects can be tracked so that their motion is compensated with respect to the stars. You may load orbital elements of comets, asteroids and artificial satellites into the mount, so that these objects can be tracked directly using the hand pad (without any external PC).



Pointing is made accurate through the usage of a model containing up to 100 stars, which allows for the correction of the classical polar alignment and conic errors, and also of the most important flexure terms of the optical tube. In this way it is possible to obtain pointing accuracies of the order of 20 arcseconds RMS. The same model can be used in order to obtain the maximum tracking accuracy, compensating also for the atmospheric refraction (depending on the local atmospheric pressure and temperature).



Detail of the mount.

A series of auxiliary functions is provided to help the user for quick aligning the mount to the celestial pole.

You may save and recover the alignment data of different observing sessions. This function is very useful if you have many instruments in different setups, each one requiring different

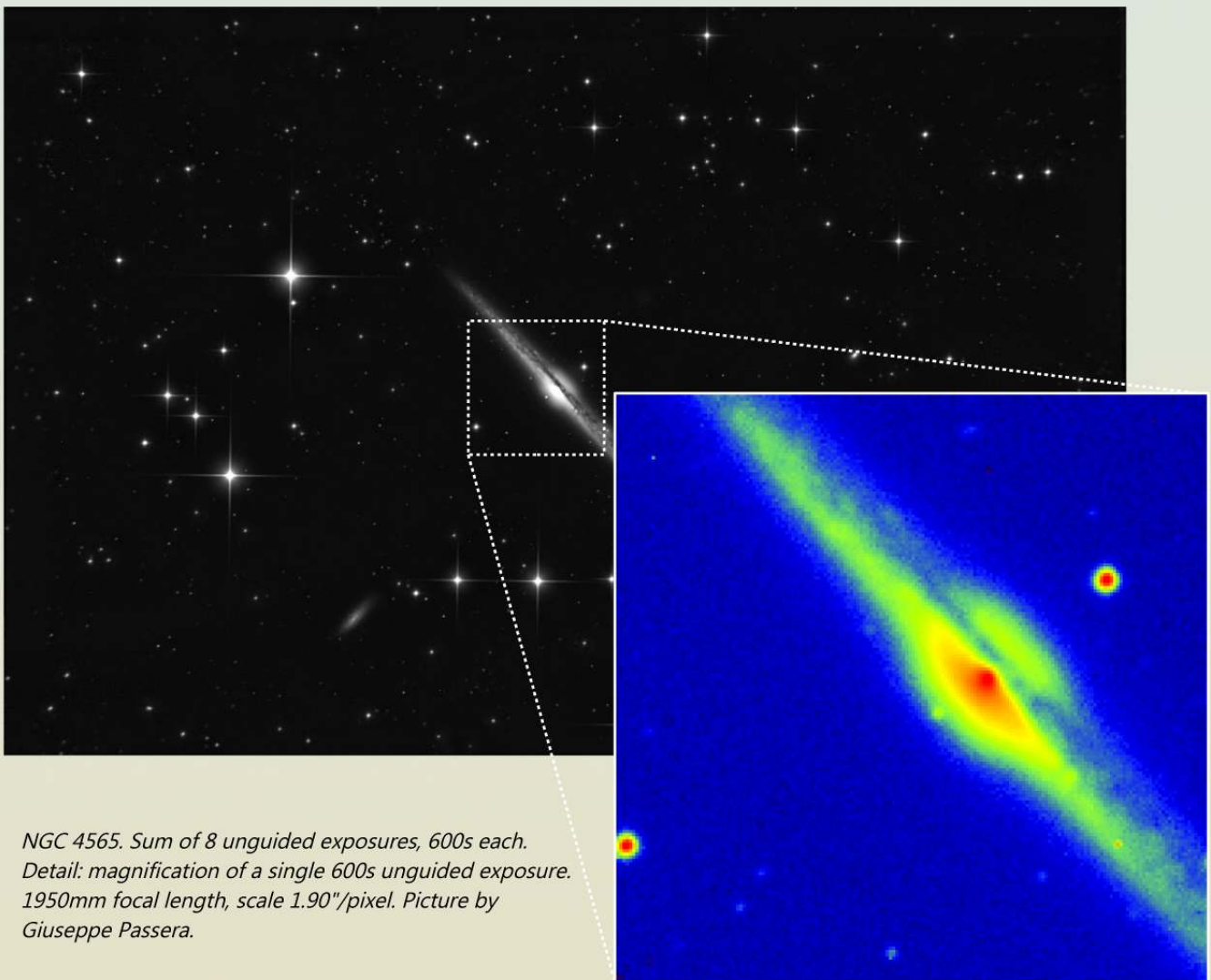

*NGC 4565. Sum of 8 unguided exposures, 600s each.  
Detail: magnification of a single 600s unguided exposure.  
1950mm focal length, scale 1.90"/pixel. Picture by  
Giuseppe Passera.*



flexure corrections.

Tracking through the meridian, a typical problem with german mounts, is solved allowing for tracking for up to 30° past the meridian (configurable), in both directions. In this way any object can be tracked for at least four hours.

The tracking accuracy makes autoguiding not necessary for many uses. The absolute encoders on both axes allows to obtain a typical tracking error below 1 arcsecond. It is possible to autoguide anyway, using the ST4-compatible port or through the serial/Ethernet connection, with a guide rate configurable from 0.1x to 1x. The guide rate can be automatically corrected for the declination of the target, so that there is no need of recalibrating the autoguide when observing at different declinations.

Designed for field use, the GM1000HPS is easily transportable. The main body of the mount, without the counterweight shaft, has a weight of only 19.5 kg – 43 lbs.



Other functions of the mount are designed in order to obtain the maximum flexibility in the most usage conditions.

The mount can be switched on and off using the dedicated connector on the control box panel.

You can use the electronic balance functions in order to balance your instrument without unlocking the clutches.

The mount can be parked in different user-defined positions.

An external dome can be controlled directly using the RS-232 serial port, avoiding the need of using a dedicated external PC. Once configured with your instrument parameters, the firmware is able to make all the calculations required for positioning the dome slit in front of your optical tube, for almost all instrument configurations.

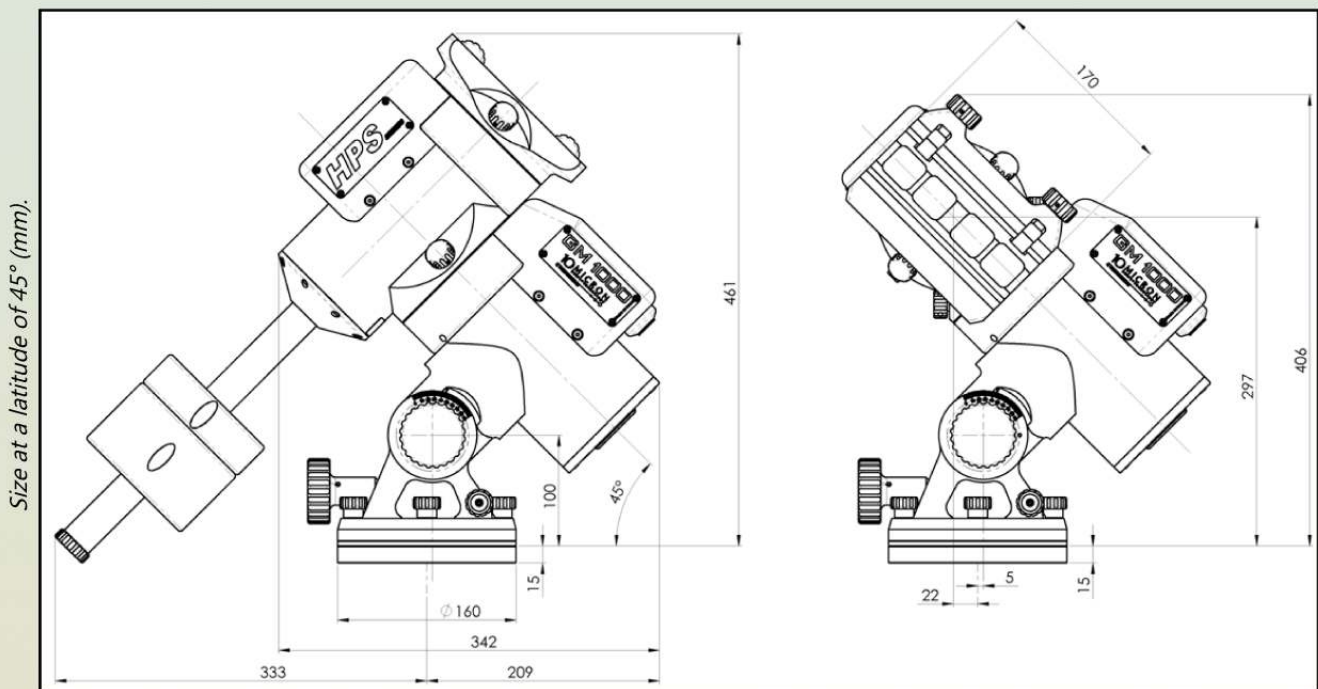



## TECHNICAL DATA SHEET

<b>Type</b>	German Equatorial Mount
<b>Weight (mount)</b>	19.5 kg – 43 lbs without accessories
<b>Instrument payload capacity</b>	~ 25 kg – 55 lbs
<b>Latitude range</b>	0° – 82° (90° optional)
<b>Azimuth fine adjustment range</b>	+/- 7.5°
<b>Counterweight shaft</b>	30 mm diameter, stainless steel, weight 1.7 kg – 3.7 lbs
<b>Axes</b>	30 mm diameter, alloy steel
<b>Bearings</b>	Pre-loaded tapered roller bearings Roller thrust bearings
<b>Worm wheels</b>	250 teeth, 125 mm diameter, B14 bronze
<b>Worms</b>	diameter 20mm, alloy steel, grinded and lapped
<b>Transmission system</b>	Backlash-free system with timing belt and automatic backlash recovery
<b>Motors</b>	2 axes AC servo brushless
<b>Power supply</b>	24 V DC
<b>Power consumption</b>	~ 0,5 A while tracking ~ 3 A at maximum speed ~ 4 A peak
<b>Go-to speed</b>	Adjustable from 2°/s to 15°/s
<b>Pointing accuracy</b>	< 20" with internal multiple-stars software mapping
<b>Average tracking accuracy</b>	< +/- 1" typical for 15 minutes (< 0.7" RMS) with multiple-stars software mapping and compensation of flexure and polar alignment errors

<b>Security stop</b>	+/- 30° past meridian in r.a. (software) +/- 45° past meridian in r.a. (mechanical)
<b>Communication ports</b>	RS-232 port; GPS port; autoguide ST-4 protocol port; Ethernet port
<b>Database</b>	Stars: by name, Bayer designation, Flamsteed designation, Bright Star Catalogue, SAO, HIP, HD, PPM, ADS, GCVS. Deep-sky: M, NGC, IC, PGC, UGC limited up to $m_v = 16$ . Solar system: Sun, Moon, planets, asteroids, comets, artificial satellites. Equatorial and altazimuth coordinates. User defined objects, fast slewing positions.
<b>Firmware features</b>	User defined mount parking position, 2-stars and 3-stars alignment function, up to 100 alignment stars for modeling, correction of polar alignment and orthogonality errors, estimate of average pointing error, storage of multiple pointing models, sidereal, solar and lunar tracking speed adjustable on both axes, declination-based autoguide speed correction, adjustable horizon height limit, pointing and tracking past meridian, assisted balance adjustment, manual or GPS based time and coordinates setting, automatic synchronization to PC clock with ClockSync proprietary software, leap second support and full accounting for the UT1 – UTC timescales, direct dome control via RS-232, configurable atmospheric refraction, network settings, comets and asteroids filter, multi-language interface. Remote Assist via Internet connection.
<b>Keypad control</b>	Rugged keypad with metal housing and reliable micro switches, large graphic display with up to five text lines and status icons, heating for low temperature operation, dimmable display and backlit keys; all the functionality of the mount is available through the keypad without requiring an external PC.
<b>PC control</b>	Remote control via RS-232 or Ethernet; proprietary ASCOM driver or LX200 compatible protocol; update of firmware and orbital elements of comets, asteroids and artificial satellites via RS-232 or Ethernet; virtual keypad control panel via RS-232 or Ethernet; integrated Wi-Fi module for connection with smartphones, tablets and any wireless network.



## ACCESSORIES FOR GM1000HPS

---

#10M2125 – #10M2130

**Losmandy dovetail bar.**

Length 300 mm (#10M2125), 400 mm (#10M2130).



#10M2105 - #10M1105

**Lodual plate - Lodual plate adapter.**

Support for two optics. Losmandy compatible, built from a 40 cm bar and two Losmandy plates, weight 4 kg – 9 lbs, center-to-center distance 27 cm. The adapter is required for mounting the plate on the GM1000 mount.

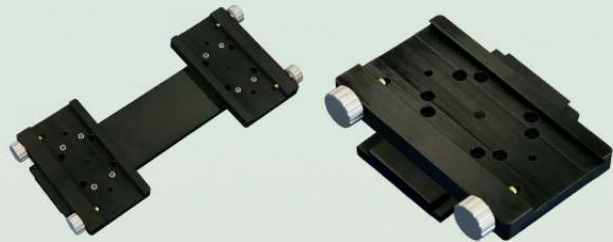

#10M1075 – #10M1080

**Counterweight.**

Weight: 3 kg – 6.6 lbs (#10M1075), 6 kg – 13.2 lbs (#10M1080).

Stainless steel.



#10M1055

**ARIES tripod.**

Includes accessory tray and waterproof cordura carry bag.



#10M1057

**30H100 tripod.**

By Geoptik. Beechwood, with accessory tray. Height adjustable from 95 cm to 110 cm.



---

#10M1090

**Adapter flange for tripod or column.**

For assembly on AHT tripod, 30H100 or pillar. Black anodized aluminum.



---

#10M1010

**GM1000 standard pillar.**

Single ground plate, 100 cm height. Custom height available on request.



---

#10M1011

**Electronics box holder for column.**

Adapter to mount the electronics box to the column for easier integration.



---

#10M1050

**Polar pointer holder.**

Holder for laser pointer (not included), for quick polar alignment.

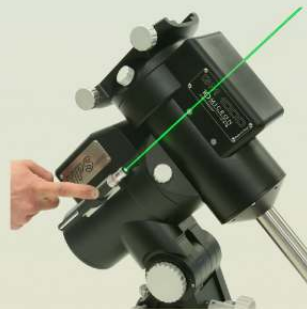

---

#10M2577

**Car lighter plug switching converter.**

From 12 VDC to 24 VDC 5 A 120 W converter, for field use with 12 V battery.





---

#10M2578

**Portable power supply.**

Input 110-240 V AC , output 24 V 4 A.



---

#10M2071

**Stabilized power supply.**

Input 110 VAC, output 24 V DC 95 W.



---

#10M4105

**GPS receiver module.**

Directly connected to the mount, provides the exact time and coordinates of the observation site.



---

#10M1065

**Mount head protective cover.**

Cordura cover with upper zip, can be placed on the mount even with payload attached.



---

#10M1063

**Professional trolley case + hand case for GM1000HPS.**

Trolley style case for the mount + hand carry case for accessories, electronics and counterweight. With internal padding and aluminum reinforced corners and edges. Dim. 62 x 45 x 28 cm + 44 x 37 x 24 cm.



---

#10M1064

**Standard trolley case + hand case for GM1000HPS.**

PLB series. Trolley style case for the mount + hand carry case for accessories, electronics and counterweight.. With internal padding. Dimensions 62 x 52 x 27.5 cm + 48 x 38.5 x 19 cm.

---



---

#10M1067

**Carrying bag.**

Reinforced cordura carrying bag with handles. Designed to recycle the shaped padding included with the standard pack. Dimensions 63 x 45 x 26 cm.

---



---

#10M1066

**Special foam fitted transport cardboard box.**

Shaped ethafoam inner padding and sturdy cardboard box with handles.

---



---

#10M5010

**PERSEUS LEVEL III software.**

By Filippo Riccio. Astronomy simulation software and mount control via PC.

---

