



# **iOptron<sup>®</sup> GEM28 German Equatorial Mount**

## **Instruction Manual**

Product GEM28 and GEM28EC



Read the included Quick Setup Guide (QSG) BEFORE taking the mount out of the case!

This product is a precision instrument and uses a magnetic gear meshing mechanism. Please read the included QSG before assembling the mount. Please read the entire Instruction Manual before operating the mount.

You must hold the mount firmly when disengaging or adjusting the gear switches. Otherwise personal injury and/or equipment damage may occur. Any worm system damage due to improper gear meshing/slippage will not be covered by iOptron's limited warranty.

If you have any questions please contact us at [support@ioptron.com](mailto:support@ioptron.com)



## **WARNING!**

***NEVER USE A TELESCOPE TO LOOK AT THE SUN WITHOUT A PROPER FILTER!  
Looking at or near the Sun will cause instant and irreversible damage to your eye.  
Children should always have adult supervision while observing.***

# Table of Content

Table of Content .....	3
1. GEM28 Overview .....	5
2. GEM28 Terms .....	6
2.1. Parts List .....	6
2.2. Identification of Parts .....	7
2.3. GEM28 Port .....	8
2.4. Go2Nova® 8409 Hand Controller .....	8
2.4.1. Key Description .....	9
2.4.2. The LCD Screen .....	9
2.5. Check the Battery .....	10
2.6. Bench Testing the Mount .....	10
3. GEM28 Mount Assembly .....	11
3.1. GEM28 Mount Assembly .....	11
4. Getting Started .....	21
4.1. Setup the Mount and Polar Alignment .....	21
4.2. Manual Operation of the Mount .....	21
4.3. Initial Star Alignment .....	21
4.4. Go to the Moon and Other Stars .....	21
4.5. Star Identifying Function .....	22
4.6. Power-Down Memorization .....	22
4.7. Turn Off the Mount .....	22
4.8. Putting the Mount Back into the Package .....	22
5. Complete Functions of Go2Nova® 8409 Hand Controller .....	23
5.1. Slew to an Object .....	23
5.1.1. Solar System .....	23
5.1.2. Deep Sky Objects .....	23
5.1.3. Stars: .....	23
5.1.4. Constellations .....	23
5.1.5. Comets .....	23
5.1.6. Asteroids .....	23
5.1.7. User Objects .....	23
5.1.8. Enter R.A. DEC .....	24
5.2. Sync to Target .....	24
5.3. Alignment .....	24
5.3.1. Pole Star Position .....	24
5.3.2. One Star Alignment .....	24
5.3.3. Two Star Polar Align .....	24
5.3.4. Three Star Align .....	25
5.3.5. Polar Iterate Align .....	25
5.3.6. Solar System Align .....	25
5.3.7. Display Model Error .....	25
5.3.8. Clear Alignment Data .....	25
5.4. Settings .....	26
5.4.1. Set Time and Site .....	26
5.4.2. Set Beep .....	26
5.4.3. Set Display .....	26
5.4.4. Set Maximum Slew Rate .....	26

5.4.5. Set Guiding Rate.....	26
5.4.6. Set Parking Position .....	27
5.4.7. Set Tracking Rate .....	27
5.4.8. Meridian Treatment .....	27
5.4.9. Set Altitude Limit .....	27
5.4.10. Wi-Fi Option .....	27
5.4.11. GPS Status .....	27
5.4.12. Language .....	28
5.4.13. Set RA Guiding (GEM28EC Only).....	28
5.5. Electric Focuser .....	28
5.6. PEC Option.....	28
5.6.1. PEC Playback .....	28
5.6.2. Record PEC .....	28
5.6.3. PEC Data Integrity .....	29
5.7. Edit User Objects.....	29
5.7.1. Enter a New Comet .....	29
5.7.2. Enter Other Objects or Observation List .....	29
5.8. Firmware Information .....	30
5.9. Zero Position .....	30
5.9.1. Goto Zero Position .....	30
5.9.2. Set Zero Position .....	30
6. Maintenance and Servicing .....	31
6.1. Maintenance .....	31
6.2. iOptron Customer Service .....	31
6.3. Product End of Life Disposal Instructions .....	31
6.4. Battery Replacement and Disposal Instructions.....	31
Appendix A. Technical Specifications .....	32
* OTA size and length dependent, recommend smaller than 6” in diameter. ** Measured with encoder on bench, 10 minutes	
Appendix B. Go2Nova® 8409 HC MENU STRUCTURE .....	32
Appendix B. Go2Nova® 8409 HC MENU STRUCTURE .....	33
Appendix C. Gear Meshing Adjustment .....	36
Appendix D. Firmware Upgrade .....	38
Appendix E. Computer Control an GEM28 Mount .....	39
Appendix F. Go2Nova® Star List.....	40
IOPTRON TWO YEAR TELESCOPE, MOUNT, AND CONTROLLER WARRANTY.....	49

# 1. GEM28 Overview

The iOptron® GEM28 and GEM28EC mount is the next-generation compact German equatorial mounts. Like their predecessors the GEM28 is designed with portability in mind, weighing in at only 10 lbs it can support up to a 28lb payload an incredible 2.8 mount weight to payload ratio. We achieved this using design methods developed to reduce mount mass in our CEM family of mounts. The German EQ versions were created to satisfy consumer that prefer a more traditional mount and to function at higher latitudes.

Building on the legacy of earlier GEM models, such as iEQ30/45 mounts, we have added features for convenience and functionality. A positive lock gear engagement system (easy to use even when wearing gloves), Built-in Wi-Fi enabling unparallel connectivity and recordable permanent periodic error correction (PPEC) to repeat optimal PEC training sessions (real time PEC on the GEM28EC). Regarding functionality the GEM28 and GEM28EC delivers precise pointing and accurate tracking (PE <0.3 arcsec rms on the EC model). The 212,000 object library ensures you'll never run out of targets to see or image. The GEM28 and GEM28EC set the new standard for compact equatorial mounts.

The mount has an integrated electronic polar finder scope known as the iPolar, or an AccuAlign™ optical polar scope. The iPolar ensures the accurate alignment of a telescope, even when the pole star is obscured.

The iOptron GEM28 mount uses the new Go2Nova® 8409 hand controller to navigate the night sky. This incredible technology helps observers find celestial objects with the aid of the mount's 212,000+ object database! For those looking for a telescope that has the capability of tracking and finding beautiful night sky objects, this mount is a must have tool.

## Features:

- German equatorial design, latitude range of 10° ~ 70°
- Ideal for both visual observation and astrophotography
- Low periodic error (< ± 10 arcsec for GEM28 and <0.3 arcsec for GEM28EC)
- Payload of 12.7 kg (28 lbs) with the mount-only weight of 4.5 kg (10 lbs)
- Spring loaded gear system
- Large easy to use quick-lock gear clutches
- Stepper motor with low power consumption
- Integrated iOptron iPolar™ electronic polar scope or AccuAlign™ dark field polar scope
- Polar alignment routine for those who can't see the Pole Star
- Go2Nova® 8409 controller with Advanced GOTO™ GOTO Technology
- Integrated ST-4 autoguiding port
- Built-in Wi-Fi
- USB port for firmware upgrade and computer control
- Standard 1.5 inch heavy-duty stainless steel tripod (5kg), optional LiteRoc™ tripod (7.5kg)
- Die-cast metal tripod spreader with accessory tray
- Optional external 32-channel Global Positioning System (GPS)
- Optional hard carrying case (standard for EC model)
- Optional iGuider™ autoguiding system #3360

## 2. GEM28 Terms

### 2.1. Parts List<sup>1</sup>

#### SHIPPING CONTENTS

Your new GEM28 mount comes in two shipping boxes. One box contains a GEM28/GEM28EC mount, hand controller, one 10.4 lbs (4.7kg) counterweight, counterweight shaft, tripod spreader and accessories. The other box contains a tripod.

- iOptron® GEM28 mount head with iPolar (#G28xAx), or iOptron® GEM28 mount head with AccuAlign™ optical polar scope (#G28xBx), or iOptron® GEM28EC mount with iPolar (#G284Ax, with red gear switch)
- Go2Nova® 8409 Hand Controller with USB port
- One 10lbs (4.5 kg) counterweight
- Stainless steel counterweight shaft
- Internal iPolar™ electronic polar scope or AccuAlign™ optical polar scope
- AC adapter (100V-240V)
- 2X coiled control Cable (6P6C RJ11 to RJ11, straight wired)
- USB cable for mount
- USB cable for iPolar or LED and cable for optical polar scope
- Aluminum carrying case (for GEM28EC and mount w/case)
- 1.5" tripod or LiteRoc™ tripod
- Quick Start Guide

#### OPTIONAL PARTS

- External GPS module (#8438)
- iGuider 1 mini autoguiding system (#3360)
- Hard case (#C268)

#### ONLINE RESOURCES *(click on the "Support" menu at [www.iOptron.com](http://www.iOptron.com))*

- Quick Start Guide
- Instructional manual
- Tips for set up
- Hand controller and mount firmware upgrades (check online for latest version)
- iOptron ASCOM driver
- Reviews and feedback from other customers
- Accessories

---

<sup>1</sup> US market only. Actual contents, design and function may vary.

## 2.2. Identification of Parts



Figure 1.GEM28 mount assembly

## 2.3. GEM28 Port

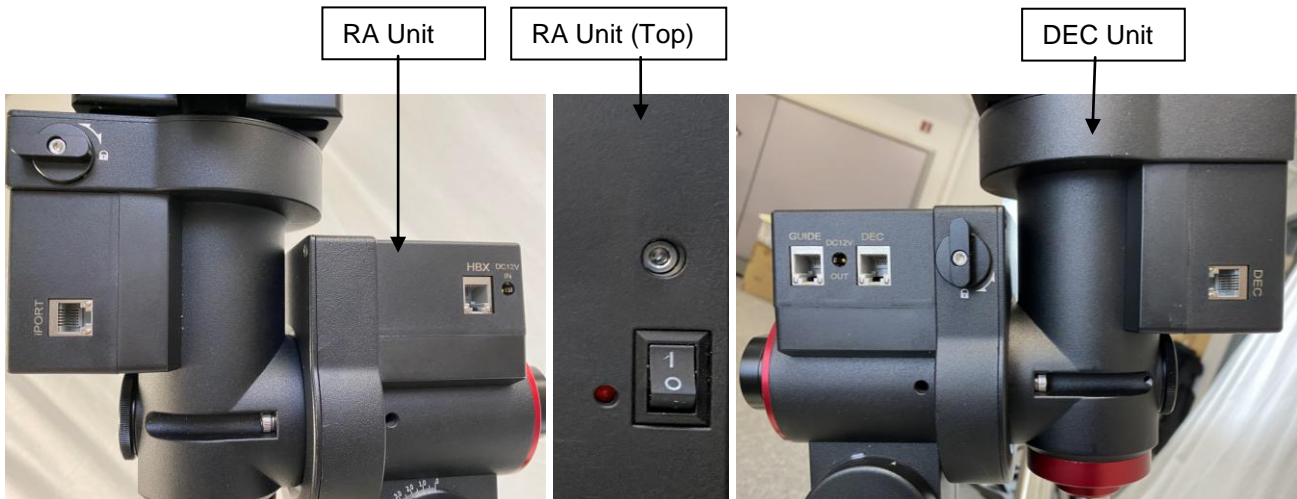

Figure 2. Ports on a GEM28 mount

### On RA Unit:

- I/O Switch: Power switch
- LED: Power indicator
- DC 12V IN: DC power socket to power the mount (2.1mmX5.5mm, center positive)
- HBX (Hand Box): For connecting to an 8409 Hand Controller
- GUIDE: ST-4 compatible autoguiding port. The wiring is shown in Figure 3

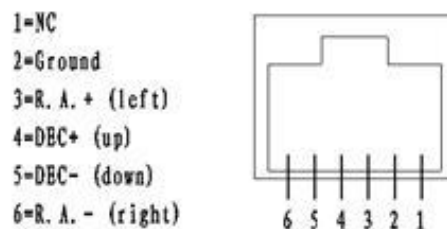

Figure 3. ST-4 Compatible Guiding Port Wiring

- DC 12 OUT: DC power socket for optical polar scope LED
- DEC: For connecting to DEC drive unit

### On DEC unit:

- DEC: Connect the DEC drive unit to RA unit via RJ11 cable
- iPORT: Auxiliary port for connecting to other iOptron accessories, such as a GPS receiver or an electronic focuser. **DO NOT** plug ST-4 guiding camera cable into this port, It will damage the guide camera electronics.

## 2.4. Go2Nova<sup>®</sup> 8409 Hand Controller

The Go2Nova<sup>®</sup> 8409 hand controller (HC) shown in Figure 4 is the standard controller used on the GEM28 mount. It has a large LCD screen, function, direction, and number keys on the front; and an HBX (6-pin) and a USB port at the bottom.





Figure 4. Go2Nova® 8409 hand controller

### 2.4.1. Key Description

- MENU Key: Press “MENU” to enter the Main Menu.
- BACK Key: Move back to the previous screen, or end/cancel current operation, such as slewing.
- ENTER Key: Confirm an input, go to the next menu, select a choice, or slew the telescope to a selected object.
- Arrow ( $\blacktriangle$   $\blacktriangledown$   $\blacktriangleleft$   $\blacktriangleright$ ) Keys: The arrow keys are used to control the movement of DEC and R.A. axes. Press and hold  $\blacktriangle$  (DEC+),  $\blacktriangledown$  (DEC-) buttons to move a telescope along the DEC direction,  $\blacktriangleleft$  (R.A.+),  $\blacktriangleright$  (R.A.-) to move a telescope along the R.A. direction. They are also used to browse the menu or move the cursor while in the menu. Press and holding an arrow key for a fast scrolling.
- Number Keys: Input numerical values. Also used to adjust speeds (1: 1X; 2: 2X; 3: 8X; 4: 16X; 5: 64X; 6: 128X; 7: 256X; 8: 512X; 9: MAX)
- Help (?) Key: Identify and display bright stars or objects that the telescope is pointing to.
- 0 Key: Stop the mount during GOTO. Also toggling between starting and stopping tracking.
- HBX (Handbox) port: connect the HC to the GEM28 mount using a 6P6C RJ11 cable.
- USB port: connect the HC to a computer for firmware upgrade and computer control.

### 2.4.2. The LCD Screen

The 8409 HC has a large 4-line, 21-character per line LCD screen. The user interface is simple and easy to learn. When the mount first turned on, an initial information screen will be displayed as shown in Figure 5, after company logo displayed. It displays the Zero Position, current date and time.

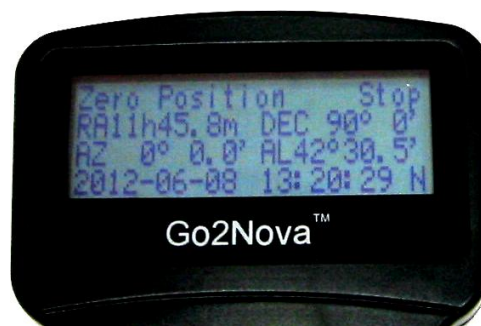

Figure 5. 8409 Initial Information Screen

The LCD screen will switch to the information screen, as indicated in Figure 6, with pressing any button.

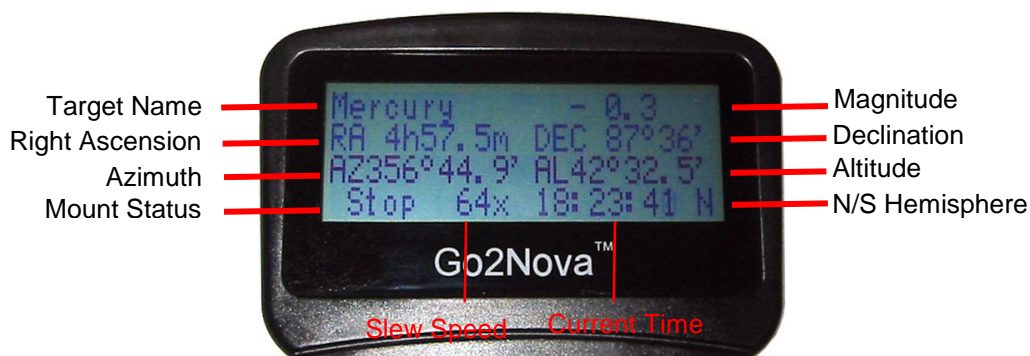

Figure 6. 8409 HC LCD Information Screen

1. Target Name/Mount Position: displays the name of the target that telescope is currently pointed to or the current mount position.
  - An object name, such as “Mercury” or “Andromeda Galaxy”: Name of the Star or celestial object that the mount is currently slewing to, GOTO or tracking;
  - User Position: The mount is point to a user defined position, which could be a real sky object or just simply due to press an arrow key.
2. Magnitude: the magnitude of the current celestial object
3. Right Ascension: Right Ascension of the telescope, or R.A.
4. Declination: Declination of the telescope, or DEC.
5. Azimuth: Azimuth of the telescope (north is 0°, east 90°, south 180°, and west 270°).
6. Altitude: Altitude of the telescope (degrees vertical from the local horizon - zenith is 90°).
7. Mount Status: Display current operation status of the mount.
  - Stop: mount is not moving;
  - Slew: mount is moving with an arrow key is pressed;
  - GoTo: mount is slewing to a celestial object using “Select and Slew”;
8. Slew speed: It has 9 speeds: 1X, 2X, 8X, 16X, 64X, 128X, 256X, 512X, MAX(1440X, or 6°/sec).
9. Current Time: display local time in a format of HH:MM:SS.

## 2.5. Check the Battery



The hand controller has a real time clock (RTC) which should display the correct time every time the mount is turned on. If the time is incorrect, please check the battery inside the hand controller and replace it if needed. The battery is a 3V lithium button battery.

## 2.6. Bench Testing the Mount

The counterweight shaft is designed to counter balance the mount’s own weight. It is recommended that the CW shaft is installed when testing the mount’s function.

**NEVER** operate the mount with only the counterweight or OTA on it. It may cause gear slippery and cause the worm and gear damage.

### 3. GEM28 Mount Assembly

#### 3.1. GEM28 Mount Assembly

**NOTE:** The GEM28 mount is a precision astronomical instrument. It is highly recommended that you read the entire manual and become familiar with the nomenclature and function of all components before starting the assembly.



**WARNING:** DO NOT rock the counterweight shaft rigorously. This may damage the worm/drive gear system and such damage will not be covered by warranty.

#### Step 1. Remove mount head from package

The RA axle is locked by an Allen wrench (blue circle). Make sure it is inserted all the way in. Check the R.A. and DEC Gear Switches and make sure they are at the unlock position before removing it from the box.



Figure 7. GEM28 mount in a case

#### Step 2. Set up tripod

The mount has a 102mm base. Thread the **Alignment Peg** onto the tripod head, on top of a tripod leg or between two legs depending on the latitude. Insert the Accessory Tray through the center rod and secure the setup by tightening Locking Knob from underneath.



Figure 8. GEM28 tripod top

### **Step 3. Attach mount head**

***Before put the mount onto the tripod, make sure the RA gear switch is at lock position to prevent mount head free swing by accident!*** Retract the 2x Azimuth (Azi) Adjustment Screws from both sides to leave ample space for the alignment peg to be fitted in between the 2x Azi Adjustment Screws. Remove the 2x Azi Locking Screws from the mount base and insert them into the opening next. Secure the mount head by tightening the Azi Locking Screws into the M6 holes on the tripod.

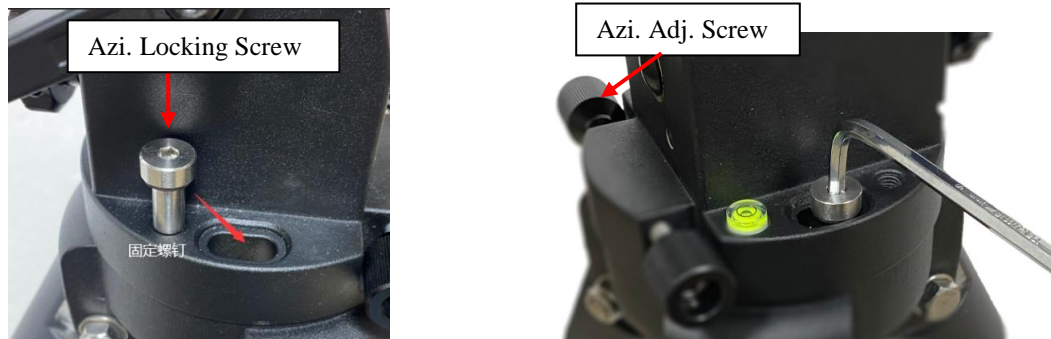

Figure 9. Attach the mount

Level the mount by adjusting the tripod legs. Use the build-in Bubble Level Indicator or an external leveler for this purpose.

### **Step 4. Adjust latitude**

Pull the Allen wrench out from the RA axle. Rotate the mount head 180° around the R.A. axis to move the dovetail face upside. There are four RA axle locking positions for the GEM28 mount: Zero Position, East and West position, and storage position.



Figure 10. Rotating GEM28 mount head upward

Loosen the Latitude Locking Lever. Turn Latitude Adj. Knob to adjust the latitude until the arrow points to the current latitude on the Latitude Scale. You may use the Allen wrench for easy adjustment. Tighten the Latitude Locking Lever.

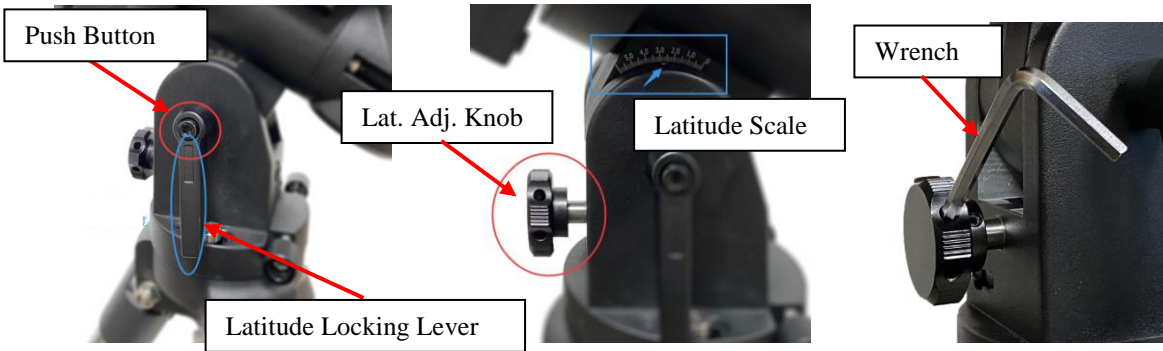

Figure 11. Adjust latitude

You may lift the Latitude Locking Lever handle by push the Push Button on this ratchet lever to disengage gear teeth and rotate freely for quick adjustment.

There are four RA axle locking positions for the GEM28 mount: Zero Position, East and West position, and storage position.

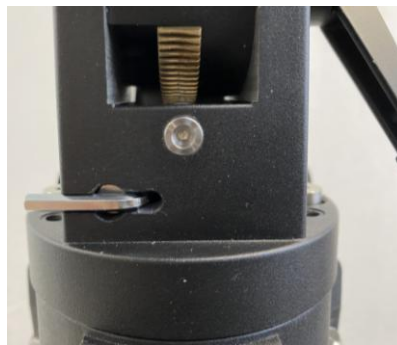

Figure 12. Allen wrench to lock the RA axle and storage

The Allen wrench can be stored on the bottom of the mount, as show in Figure 12.

### **Step 5. Install counterweight (CW) shaft**

Unscrew the CW shaft from the top of the mount as shown in **Error! Reference source not found.**(a) and thread it into the opening of the DEC axis as shown in **Error! Reference source not found.**(b).



Figure 13. Install counterweight shaft

## **Step 6. Install counterweight**

Before putting on CW, make sure the mount is at its zero position, *i.e.*, CW shaft points to the ground. **Insert Allen wrench to lock the RA axle** and disengage the R.A. Gear Switch to set the R.A. axis free before loading the CW. Remove the CW Safety Cap at the end of CW Shaft. Glide the CW over the shaft with the larger opening facing down. Tighten the CW Locking Screw to hold the CW in place. Place the Safety Cap back onto the shaft. Move the CW to the bottom of the shaft and tighten the CW locking Screw.

GEM28 comes with a 10.4 lbs (4.7 kg) CW, which should be sufficient for an 6" scope with total payloads up to about 12 lbs. Use extra CW or CW Extension Bar to balance higher payloads.



Figure 14. Install counterweight

## **Step 7. Install telescope**

GEM28 has a 3.5" Vixen dovetail saddle, with a Center Adjusting Block. This can be used to accommodate dovetail bars with different width and keep the OTA centered. Release the locking screws (blue circled) on the Center Adjusting Bar first. Adjust the setting screws (red circled) to move the center block in or out. Then tighten the locking screws. Tighten the set screws at last.

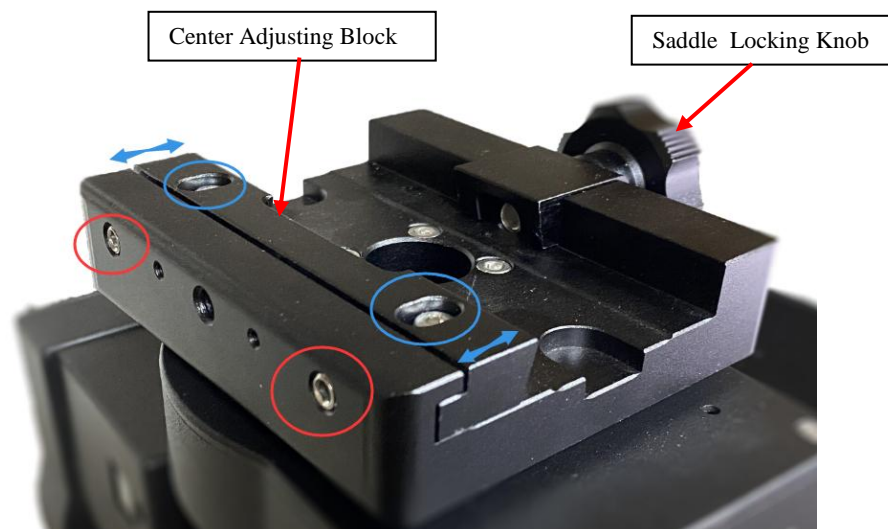

Figure 15. GEM28 Vixen dovetail saddle with Center Adjusting Block

To mount a telescope on to the mount, release the dovetail Saddle Locking Knob and slide the telescope dovetail plate into the saddle. Tighten the Saddle Locking Knob.

There are two threaded holes on the side of the dovetail saddle for mounting an iOptron mini autoguiding system, iGuider.



Figure 16. iGuider mini-autoguiding system

### **Step 8. Balance payload**

After attaching the scope and accessories, the mount head assembly must be balanced in both DEC and RA axes to ensure minimum stresses on the mount driving mechanism.

**CAUTION: The telescope may swing freely when the R.A. or DEC Gear Switch is disengaged. Always hold on to the mount and/or telescope assembly before releasing the Gear Switches to prevent it from sudden swinging, which can cause personal injuries and/or equipment damages.**

Set the mount at Zero Position. Disengage both RA and DEC gear switches and move the mount to horizontal position to check balance. Return to Zero Position for balance adjustment. Balance the DEC axis by moving the scope with accessories back and forth in the mount saddle or within the scope mounting rings. Balance the assembly in R.A. axis by moving CW along its shaft. Repeat the process until both DEC and RA axes are balanced.

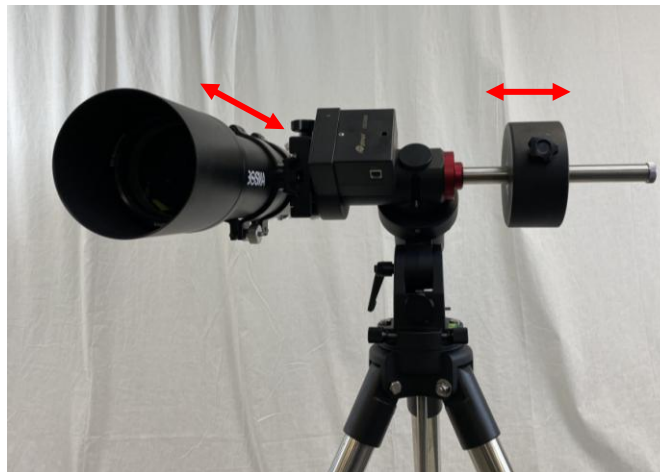

Figure 17. Balance a telescope

**CAUTION: The balancing process MUST be done with Gear Switch at the total disengaged position! Otherwise it might damage the worm system.**

Return the mount to Zero Position after balancing and engage gear switches.

### **Step 9. Connect cables**

Use the short RJ11 cable to connect the DEC control unit to the **DEC** port of the RA control unit.



Figure 18. Connect DEC cable

Connect the Go2Nova<sup>®</sup> 8409 Hand Controller to the **HBX** port on the RA unit. Plug in a 12V DC power supply to the **DC12V IN** socket next to the **HBX** port (**NOT the DC12V OUT on the other side**).



Figure 19. Ports for cables

Plug optional GPS module into the **iPORT** with a coiled cable. When powering on, GPS ON sign should be displayed at the upper right corner of the hand controller. You may disconnect the GPS module after it picks up satellites signals and displays GPS OK. (It takes a few minutes in normal conditions).

### **STEP 10. Set hand controller**

If a GEM28 is equipped with a GPS receiver, it will receive the time, longitude and latitude information from satellites after the link is established. However, there are still some parameters need to be entered to reflect your location, such as time zone info (**UTC offset**) and daylight saving time (**DST**). The information will be stored inside the hand controller memory along with longitude and latitude coordinates until they need to be changed.

A clear sky and open space outside is needed for the GPS to establish its link with the satellites. The GPS is installed on top of the R.A. motor control board. **Do not leave the hand controller on GPS Status submenu waiting for GPS ON tuning into GPS OK.**

To set up the controller, turn the mount power ON. Press **MENU**=> "**Settings**":

```

Select and Slew
Sync. to Target
Alignment
Settings
  
```

Press **ENTER** and select "**Set Time and Site**"



```

Set Time and Site
Set Beep
Set Display
Set Guiding Rate

```

Press ENTER. A time and site information screen will be displayed:

```

2020-10-01 12:01:36
UTC -300 Minute(s)
W071d08m50s      DST: N ← Daylight Saving Time
N42d30m32s      Northern

```

**Set Local Time**

The time will be updated automatically when the GPS receiver has established its link with the GPS satellites. In the event that the GPS module is unable to establish a link to the satellites, local time can be entered manually. Use the ◀ or ▶ key to move the cursor █ and use the number keys to change the numbers. Use the ▲ or ▼ button to toggle between “Y” and “N” for Daylight Saving Time, or “+” and “-“ for UTC (Coordinated Universal Time) setting. Hold the arrow key to fast forward or rewind the cursor.

In order to make the hand controller reflect your correct local time, **time zone information has to be entered**. Press the ◀ or ▶ key, move the cursor to the third line “UTC -300 Minute(s)” to set the time zone information (add or subtract 60 minutes per time zone). For example:

- Boston is “UTC -300 minutes”
- Los Angeles is “UTC -480 minutes”
- Rome is “UTC +60 minutes”
- Beijing is “UTC +480 minutes”
- Sydney is “UTC +600 minutes”

All the time zones in North America are “UTC -”, as shown in the following table, so ensure the display shows “UTC -” instead of “UTC +” if in North or South America.

Time Zone	Hawaii	Alaska	Pacific	Mountain	Central	Eastern
Hour behind UT	-10	-9	-8	-7	-6	-5
Enter UTC	-600	-540	-480	-420	-360	-300

To adjust minutes, move the cursor to each digit and use the number keys to input the number directly. Use ▲ or ▼ key to toggle between “+” and “-“. When the time information entered is correct, press ENTER and go back to the previous screen. **Note that fractional time zones can be entered.**

Do not manually add or subtract an hour from displayed time to reflect Daylight Saving Time (DST). Instead please select “Y” for DST when daylight saving time begins.

For other parts of the world you can find your “time zone” information from internet.

**Set Observation Site Coordinate**

The third and fourth lines display the longitude and latitude coordinates, respectively. The longitude and latitude coordinates will be automatically updated when the GPS picks up satellite signals. “W/E” means western/eastern hemisphere; “N/S” means northern/southern hemisphere; “d” means degree; “m” means minute; and “s” means second.

If, for any reason, your GPS can’t pick up a signal, you can manually enter the GPS coordinates. Press ◀ or ▶ key to move the cursor and using ▲ or ▼ key to toggle between “W” and “E”, “N” and “S”,

using number key to change the numbers. It is always a good idea to do your home work to get the GPS coordinates before traveling to a new observation site.

The site coordinates information can be found from your smart phone, GPS receiver or via the internet. Site information in decimal format can be converted into d:m:s format by multiplying the decimal numbers by 60. For example, N47.53 can be changed to N47°31'48":  $47.53^\circ = 47^\circ + 0.53^\circ$ ,  $0.53^\circ = 0.53 \times 60' = 31.8'$ ,  $0.8' = 0.8 \times 60'' = 48''$ . Therefore,  $47.53^\circ = 47^\circ 31' 48''$  or 47d31m48s.

### **Select N/S Hemisphere**

If the polar axis is aligned to the North Celestial Pole, then set the mount to Northern Hemisphere. If the polar axis is pointing to the South Celestial Pole, set the mount to Southern Hemisphere. Press the ◀ or ▶ key to move the cursor and use the ▲ or ▼ key to toggle between “Northern Hemisphere” and “Southern Hemisphere”.

As an example, select Northern Hemisphere if you are located in US and press **ENTER** to go back to the main menu.

The time and site information will be stored inside the hand controller’s memory chip. If you are not traveling to another observation site, they do not need to be changed.

### **Check the Hand Controller Battery**

The hand controller has a real time clock which should display the correct time every time the mount is turned on. If the time is off too much, please check the battery inside the hand controller and replace it if required. The battery is a 3V lithium button battery.

## **STEP 11. Perform polar alignment**

A GEM28 mount may be equipped with an iPolar™ electronic polar scope or an AccuAlign™ optical polar scope.

### ***iPolar Polar Alignment***

For a GEM28 with an iPolar, refer to iPolar Operation Manual from iOptron’s website to perform the polar alignment, or steps briefly outlined below:

- Download and install iPolar Software (first time use);
- Connect a mini USB cable between the iPolar and a computer USB port;



Figure 20. USB port on an iPolar electronic polar scope

- Click Connect and start polar alignment by following on screen instructions.

### ***Quick Polar Alignment***

If the mount equipped with an AccuAlign™ optical polar scope, you can use the Quick Polar Alignment procedure to perform the polar alignment. One of the GEM28’s unique features is that the polar

scope can be used at anytime as it is not blocked by DEC axle as is the case in a German Equatorial Mount. This makes it possible to adjust the polar alignment while the mount is tracking.

As indicated in Figure 21, the Polar Scope reticle has been divided into 12 hours along the angular direction with 10-minute tics. There are 6 concentric circles in 2 groups of 3 marked from 36' to 44' and 60' to 70', respectively. The 36' to 44' concentric circles are used for polar alignment in the Northern Hemisphere using Polaris, while the 60' to 70' circles are used for polar alignment in Southern Hemisphere using Sigma Octantis.

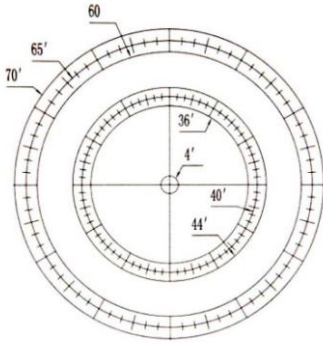

Figure 21. Polar Scope



Figure 22. Connect polar scope LED

To perform the polar alignment:

- (1) Level the GEM28 mount and set it to the Zero Position. Make sure the telescope optical axis is parallel to the polar axis (R.A. axis) of the mount. If using a finder scope, adjust it to be parallel to the telescope optical axis.
- (2) Remove both the polar axis cover. Thread the polar scope LED to the Polar Scope. Connect one end of the polar scope power cable to the illumination LED and the other end to the DC12V output located on RA Unit (Figure 22).
- (3) Turn the mount power on.
- (4) Adjust the polar scope dial to rotate one of the major ticks at the top.
- (5) Use the Hand Controller (**MENU** => "**Alignment**" => "**Position of Polaris/SigmaOct**") to display the current position of Polaris on the LCD screen, as indicated in the left side of the figure below. For example, June 22, 2014, 20:19:42 in Boston, US (long. W71°08'50" and lat. N42°30'32", UTC - 300 min,) the Polaris Position is 0h45.8m and 40.4m.

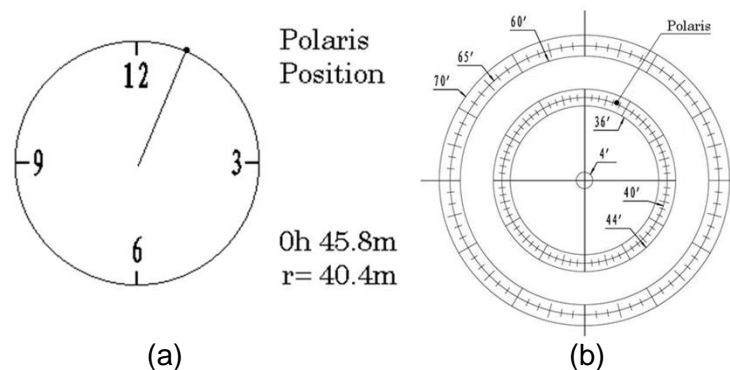

Figure 23. Polaris position shown on HC (a) and where to put on polar scope reticle (b)

- (6) Look through the polar scope to find the Polaris. Use the Azimuth and Latitude Adj. Knobs to adjust the mount in both directions and put the Polaris in the location on the Polar Scope Dial (same as indicated on the HC LCD), as shown in **Error! Reference source not found.** (b).

**NOTE: If you are located in the Southern Hemisphere, Sigma Octantis will be chosen for Polar Alignment.**

### ***BrightStar Polar Alignment***

If your mount does not have an iPolar installed, or the pole star is not in sight, you may use two bright stars with **Polar Iterate Align** to do the polar alignment.

- (1) Level the mount and set it to the Zero Position. Align the telescope to the R.A. axis of the mount. If a finder scope is used, adjust it to be parallel to the telescope optical axis.
- (2) Use the HC (**MENU => "Alignment" => "Polar Iterate Align"**) to display the azimuth and altitude position of several bright stars near the meridian. Select one that is visible at a high altitude as Alignment Star A. Follow the HC instruction to move Alignment Star A to the center of the eyepiece using a combination of the Latitude Adjustment Knob and the "**<**" or "**>**" buttons. Press **ENTER** to confirm when the star is centered. Next, select a bright star that is close to the horizon as Alignment Star B. Center it using the Azimuth Adjustment Knob and the "**<**" or "**>**" button (*the "**↑**" and "**↓**" buttons are not used here*). Press **ENTER** to confirm the settings.
- (3) The telescope will now slew back to Alignment Star A. Repeat the steps above. The iteration can be stopped when it is determined that the alignment error has been minimized. Press the **BACK** button to exit the alignment procedure.

**NOTE:** It is highly recommended to use an eyepiece with an illuminated crosshair for accurate centering.

**NOTE:** The movement of the alignment star in your eyepiece may not be perpendicular depending on its location in the sky.

### **STEP 11. Return Mount to Zero Position**

After polar alignment and balancing OTA, return the mount to Zero Position. The Zero Position is the position with the CW shaft pointing toward the ground, OTA at the highest position with its axis parallel to the polar axis and the OTA pointing to the Celestial Pole.

To set the mount to Zero Position, press **MENU=>"Zero Position"=>"Set Zero Position"**. Release the Gear Switch to manually return the mount to Zero Position, or use the hand controller to slew the mount to Zero Position. Press **ENTER** to confirm the zero position.

Set the Zero Position or check the Zero Position by using **MENU=>"Zero Position"=>"Goto Zero Position"** before each session.

## 4. Getting Started

In order to experience the full GOTO capability of GOTO<sup>NOVA</sup>® technology it is very important to set up the mount correctly before observation.

### 4.1. Setup the Mount and Polar Alignment

Assemble your GEM28 mount according to Section 3.1. Mount an OTA and accessories, and carefully balance the mount around the polar axis. Turn the mount power switch on. Check the date and site info. Perform polar alignment.

Always check if the mount is at the Zero Position when the mount is powered on, i.e. with the counterweight shaft pointing to ground, OTA at the highest position with its axis parallel to the polar axis and the telescope pointing to the Celestial Pole. Press **MENU** => **“Zero Position”** => **“Goto Zero Position”** to check it. If the mount is not at the Zero Position, press **MENU** => **“Zero Position”** => **“Set Zero Position.”** Release the Gear Switch to manually return the mount to Zero Position, or use the hand controller to slew the mount to Zero Position. Press **ENTER** to confirm the zero position..

### 4.2. Manual Operation of the Mount

You may observe astronomical objects using the arrow keys of a Go2Nova<sup>®</sup> hand controller.

Flip the I/O switch on the telescope mount to turn on the mount. Use **▶**, **◀**, **▼** or **▲** buttons to point the telescope to the desired object. Use the number keys to change the slewing speed. Then press **0** button to start tracking. Press **0** button again to stop the tracking.

### 4.3. Initial Star Alignment

Perform a simple one star alignment/synchronization after set up the hand controller to correct any pointing discrepancy of the Zero Position and to improve the GOTO accuracy.

To perform **“One Star Align,”** press **MENU=>“Alignment”=>“One Star Align”=>ENTER**. The screen will display a list of bright objects for you to select from. Select an object using **▲** or **▼** key. Then press **ENTER**. After the mount slews to the target, use the arrow keys to center it in your eyepiece. Then press **ENTER**. (More align details in 5.4)

An alternate way is to perform **“Sync to Target.”** Press **MENU=>“Select and Slew”=>ENTER**. Browse over the catalogs and select an object. Press **ENTER**. After the mount slews to the star, press **MENU=>“Sync. To Target”**, follow the on-screen instruction to center the star and press **ENTER**. You may need to use the number keys to change the slewing speed to make the centering procedure easier.

### 4.4. Go to the Moon and Other Stars

After performing these set-ups the mount is ready to GOTO and track objects. One of the most common objects is the Moon.

To slew to the Moon press **MENU=>“Select and Slew”=>“Solar System”=>Moon=>ENTER**. The telescope will automatically slew to the Moon and lock on it. It will automatically begin to track once it locks on. If the Moon is not centered in your eyepiece, use the arrow keys to center the Moon. You may use **“Sync to Target”** to improve the tracking.

You may also select other bright celestial objects to start with, such as Jupiter or Saturn.

#### **4.5. Star Identifying Function**

The 8409 hand controller has a star identifying function. After **Polar Alignment** and **Set Up Time and Site**, slew the telescope to an bright star, manually or using GOTO. Press ? button to identify the star name telescope is pointing to, as well as nearby bright stars if there are any.

#### **4.6. Power-Down Memorization**

The GEM28 mount can memorize its R.A. and DEC positions if the mount power is lost during operation, even during high speed slewing. After the power is back, just do a **Select and Slew** to the same star when the power is lost. The mount will continue to track the star.

#### **4.7. Turn Off the Mount**

When you have finished your observation, simply turn the mount power off and disassemble the mount and tripod.

If the mount is set up on a pier or inside an observatory, it is recommended that you return the mount to the Zero Position or park the telescope. This will ensure that there is no need for you to perform the initial setup again when you power on the mount subsequently so long as the mount has not been moved from the parked position.

#### **4.8. Putting the Mount Back into the Package**

Lock the RA axle with the Allen wrench. Disengage the gear system for transportation.

## 5. Complete Functions of Go2Nova® 8409 Hand Controller

### 5.1. Slew to an Object

Press **MENU** => “**Select and Slew.**” Select an object that you would like to observe and press the **ENTER** key.

The Go2Nova® 8409 hand controller for GEM28 mount has a database of over 212,000 objects. Use the ► or ◀ buttons to move the cursor. Use the number buttons to enter the number, or the ▼ or ▲ buttons to change the individual number. Hold on a button to fast scroll through the list. The “☉” indicates the object is above the horizon, and a cross mark “☼” means it is below the horizon. In some catalogs those stars below the horizon will not display on the hand controller.

#### 5.1.1. Solar System

There are 9 objects in the Solar system catalog.

#### 5.1.2. Deep Sky Objects

This menu includes objects outside our Solar system such as galaxies, star clusters, quasars, and nebulae.

- Named Objects: consists of 60 deep sky objects with their common names. A list of named deep sky objects is included in Appendix.
- Messier Catalog: consists of all 110 Messier objects.
- NGC Catalog: consists of 7,840 objects in NGC catalog.
- IC Catalog: consists of 5,386 objects in IC catalog.
- UGC Catalog: consists of 12,921 objects.
- Caldwell Catalog: consists of 109 objects.
- Abell Catalog: consists of 4076 objects.
- Herschel Catalog: consists of 400 objects.

#### 5.1.3. Stars:

- Named Stars: consists of 259 stars with their common names. They are listed alphabetically. A list is included in Appendix.
- Binary Stars: consists of 208 binary stars. A list is attached in Appendix.
- Hipparcos Catalog: the new HIP catalog consists of 120,404 records (2008).

#### 5.1.4. Constellations

This catalog consists of 88 modern constellations with their names. They are listed alphabetically.

#### 5.1.5. Comets

This catalog contains 15 comets.

#### 5.1.6. Asteroids

This catalog contains 116 asteroids.

#### 5.1.7. User Objects

It can store up to 60 used entered objects, including comets.

### 5.1.8. Enter R.A. DEC

Here you can go to a target by entering its R.A. and DEC numbers.

## 5.2. Sync to Target

This operation will match the telescope's current coordinates to Target Right Ascension and Declination. After slewing to an object, press **MENU** => "**Sync to Target**" => **ENTER**. Follow the screen to perform the sync. Using this function will re-calibrate the computer to the selected object. Multiple syncs can be performed if needed. This operation is most useful to find a faint star or nebula near a bright star.

"**Sync to Target**" will only work after "**Select and Slew**" is performed. You can change the slewing speed to make the centering procedure easier. Simply press a number (1 through 9) to change the speed. The default slew speed is 64X.

"**Sync to Target**" will improve the local goto accuracy around the synced star.

## 5.3. Alignment

This function is used for aligning the telescope to the celestial pole and to create a sky model to calibrate the mount's GOTONOVA<sup>®</sup> functionality.

The hand controller provides two polar alignment methods. The "**Two Star Polar Align**" is used to refine the polar alignment using the AccuAlign<sup>™</sup> polar scope and **Quick Polar Alignment**. The "**Polar Iterate Align**" uses a set of 2 bright stars for polar alignment providing a viable polar alignment approach for those who can't see the pole.

The system provides three alignment methods to calibrate the mount's GOTO function: "**Solar System Align**", "**One Star Align**", and "**Three Star Align**". The mount has to be at Zero Position before performing any alignment.

**The alignment data is only stored in the mount. It won't be synced/used to a computer when planetarium software is used to control the mount.**

### 5.3.1. Pole Star Position

This function displays the position of the Pole Star for **Quick Polar Alignment** using the iOptron<sup>®</sup> AccuAlign<sup>™</sup> polar scope. In the Northern Hemisphere the position of Polaris is displayed, while in the Southern Hemisphere the position of Sigma Octantis is shown.

### 5.3.2. One Star Alignment

Press **MENU** => "**Alignment**" => "**One Star Align**". A list of alignment stars that are above the horizon is computed based on your local time and location. With the mount in the Zero Position, use the ▲ and ▼ buttons to select a star and press **ENTER**. Center the target in your eyepiece using the arrow keys. Press **ENTER** when finished. If your mount is set up correctly and polar aligned, one star alignment should be sufficient for good GoTo accuracy. To increase the pointing accuracy over the sky, you may choose to do a three star alignment.

### 5.3.3. Two Star Polar Align

**Two Star Polar Align** can improve the accuracy of the mount's polar alignment. Press **MENU** => "**Alignment**" => "**Two Star Polar Align**." A list of alignment stars that are above the horizon is computed based on your local time and location. With the mount at the Zero Position, use the ▲ and ▼ buttons to select the first alignment star and press **ENTER**. Center the target in your eyepiece using the arrow keys



after the mount slews to it. Press **ENTER** when finished. The hand controller will prompt you to choose a second star. After centering the second star, the two-star alignment is finished.

After the two-star alignment, the altitude and azimuth errors will be displayed. This number can be used to fine tune the Quick Polar Alignment.

For example, if the screen shows 7.5" low and 4.3" east, it means that THE MOUNT axis is pointing low and to the east of the Celestial Pole.

#### 5.3.4. Three Star Align

The three-star alignment will further determine the cone error between the OTA and mount axis. The system will use these data to calculate the goto model. If the cone error is big enough, it is suggested to shim the OTA in DEC to minimize it.

Press **MENU** => "**Alignment**" => "**Three Star Align**." A list of alignment stars that are above the horizon is computed based on your local time and location. With the mount at the Zero Position, use the ▲ and ▼ buttons to select the first alignment star and press **ENTER**. Center the target in your eyepiece using the arrow keys. Press **ENTER** when finished. The hand controller will prompt you to choose a second star. Select third star after the mount aligned to the second star.

The system will display the pointing and cone errors after the three star alignment accepted. The system will update the pointing model accordingly.

#### 5.3.5. Polar Iterate Align

This alignment method allows you to polar align the mount even if you cannot view the Celestial Pole. Press the **MENU** => "**Alignment**" => "**Polar Iterate Align**". The HC will display a list of bright alignment stars near the meridian as Alignment Star A. Follow the HC instructions to move Alignment Star A to the center of the eyepiece using a combination of the Latitude Adjustment Knob and the "◀" and "▶" buttons. Press **ENTER** to confirm the settings. Next, select a bright star that is close to the horizon as Alignment Star B. Center it using the Azimuth Adjustment Knobs and the "◀" and "▶" buttons (*the "▲" and "▼" buttons will not function*). Press **ENTER** to confirm the settings.

The telescope will now slew back to Alignment Star A to repeat the above steps. The iteration can be stopped when it is determined that the alignment error has been minimized. Press the **BACK** button to exit the alignment procedure.

**NOTE:** It is highly recommended to use an eyepiece with illuminated crosshairs for accurate centering.

**NOTE:** The movement of the alignment star in your eyepiece may not be perpendicular depending on its location in the sky.

#### 5.3.6. Solar System Align

This function uses a planet or the moon as an alignment object. Press **MENU** => "**Alignment**" => "**Solar System Align**" for a list of available alignment objects.

#### 5.3.7. Display Model Error

This will display linear RA error, linear DEC error, polar misalignment, non-perpendicular between OTA and DEC, and non-perpendicular between HA and DEC.

#### 5.3.8. Clear Alignment Data

This will clear all alignment data created during one star, two star or three star alignment process.

## 5.4. Settings

### 5.4.1. Set Time and Site

Refer to STEP 10 in Section 3.1.

### 5.4.2. Set Beep

The Hand Controller allows a user to turn off the beep partially, or even go to a silent mode. To change this setting press **MENU** => "**Settings**" => "**Set Beep**",

```
Set Up Time and Site
Set Beep
Set Display
Set Guiding Rate
```

Select one of three available modes:

"**Always On**" – a beep will be heard on each button operation or mount movement;

"**On but Keyboard**" – a beep will be heard only when the mount is slewing to the object or there is a warning message;

"**Always Off**" – all sounds will be turned off, including the SUN warning message.

### 5.4.3. Set Display

Press **MENU** => "**Settings**" => "**Set Display**,"

```
Set Up Time and Site
Set Beep
Set Display
Set Guiding Rate
```

Use the arrow keys to adjust LCD display contrast (**LCD contrast**), LCD backlight intensity (**LCD light**), and keypad's backlight intensity (**Key light**).

### 5.4.4. Set Maximum Slew Rate

This function will help the mount to slew properly under low temperature or extreme payload condition (extra long or large diameter scope). Press **MENU** => "**Settings**" => "**Set Maximum Slew Rate**,". You can select one of three slew rates. The default is MAX.

### 5.4.5. Set Guiding Rate

This is an advanced function for autoguiding when a guiding camera is utilized either via a Guide Port or using the ASCOM protocol. Before autoguiding, align the polar axis carefully. Select an appropriate guiding speed. The latest firmware allow you to set the R.A. and DEC guiding speed differently. The R.A. guiding speed can be set between  $\pm 0.01X$  to  $\pm 0.90X$  sidereal rate. The DEC guiding speed can be set between  $\pm 0.10X$  to  $\pm 0.99X$  sidereal rate. Follow the instructions of your autoguiding software for detailed guiding operation. The default number is 0.5X.

The guide port wiring is shown in **Figure 3**, which has the same pin-out as that from Celestron / Starlight Xpress / Orion Mount / Orion/ QHY/ZWO autoguider camera.

If you have an autoguider which has a pin-out the same as the ST-I from SBIG, such as Meade/ Losmandy/ Takahashi/ Vixen, make sure a proper guiding cable is used. Refer to your guiding camera and guiding software for detailed operation.

**WARNING: DO NOT plug your ST-4 guiding camera cable into the iOptron port or HBX port. It may damage the mount or guiding camera electronics.**

### 5.4.6. Set Parking Position

You may park the telescope before powering off the mount. This is very useful if the mount is on a permanent pier or the mount will not be moved in between observation sessions. The mount will keep all the alignment info and reference points.

There are five parking positions. Two positions that park the scope horizontally (**Horizon Position**). Two positions that park the scope vertically (**Zenith Position**). "**Current Position**" will park the scope at its current position. When the mount is turned on, it will use the last parking position setting as the default setting.

### 5.4.7. Set Tracking Rate

You can set up the mount tracking rate by selecting "**Set Tracking Rate**". Then the user can select "**Sidereal Rate**", "**Lunar Rate**", "**Solar Rate**", "**King Rate**", and "**User Defined Speed**". The "User defined speed" can be adjusted from 0.9900X to 1.0100X of sidereal.

The "King Rate", developed by Edward S. King, corrects the tracking rate of a telescope to account for atmospheric refraction. This is more useful for unguided tracking.

### 5.4.8. Meridian Treatment

This function tells the mount what to do when it tracks past the meridian. You can tell the mount if it needs a meridian flip and when to do it.

- "**Set Position Limit**" will tell the mount when to stop tracking or to do a meridian flip. The limit can be set at from 0° to 20° (80 minutes) pass meridian.
- "**Set Behavior**" will determine if the mount will stop tracking or perform a meridian flip at the set position limit.

### 5.4.9. Set Altitude Limit

This function allows the mount to keep tracking an object even if it is below the horizon but can still be seen, for example from an elevated observation site, such as a hill. The range can be set from -89° to +89°. The default limit is 00°. **Be careful when setting this limit.** It may cause mount goto problems.

### 5.4.10. Wi-Fi Option

This function will display WI-FI module functions. It is useful when connect the mount via wireless connection.

```
Wireless Status
Restart
Restore to factory
```

Click on **Wireless Status**: displays will show:

- **SSID**: HBX8409\_XXXXXX
- **IP**: 010.010.100.254
- **Port**: 08899
- **MAC**: XX-XX-XX-XX-XX-XX

Click on **Restart** will restart the Wi-Fi adapter and **Restore to Factory** to restore the factory settings.

### 5.4.11. GPS Status

Display if the GPS connection status. GPS ON indicates that the mount is still acquiring the satellite data. GPS OK indicates the link has been established. GPS OFF indicates there is no GPS or the GPS is malfunctioning. Do not leave the hand controller at this submenu.

### 5.4.12. Language

Select one of supported menu languages. Currently it has English and Chinese.

### 5.4.13. Set RA Guiding (GEM28EC Only)

You can turn off R.A. guiding by selecting “**Filter R.A. Guiding**” to allow the high precision encoder to correct the tracking error, or turn the R.A. guiding on by selecting “**Allow RA Guiding**” to allow the mount to receive guiding corrections from the autoguiding software.

## 5.5. Electric Focuser

This function controls an iOptron electric focuser.

## 5.6. PEC Option

PEC for short is a system that improves the tracking accuracy of the drive by reducing the number of user corrections needed to keep a guide star centered in the eyepiece. PEC is designed to improve photographic quality by reducing the amplitude of the worm errors. Using the PEC function is a three-step process. First, the system needs to know the current position of its worm gear so that it has a reference when playing back the recorded error. Next, you must guide for at least 10 minutes during which time the system records the correction you make. (It takes the worm gear 10 minutes to make one complete revolution). This “teaches” the system the characteristics of the worm. The periodic error of the worm gear drive will be stored in the hand controller and used to correct periodic error. The last step is to play back the corrections you made during the recording phase. Keep in mind, the PEC only compensate the RA worm error.

### 5.6.1. PEC Playback

You can turn “**PEC Playback On**” while you do the tracking, especially for long time astrophotography. The default status is **PEC Playback Off** when the mount is turned on.

### 5.6.2. Record PEC

Here’s how to record the PE curve manually:

1. Find a bright star relatively close to the object you want to photograph.
2. Insert a high power eyepiece with illuminated cross hairs into your telescope. Orient the guiding eyepiece cross hairs so that one is parallel to the declination while the other is parallel to the R.A. axis.
3. Center the guide star on the illuminated cross hairs, focus the telescope, and study the periodic movement.
4. Before actually recording the periodic error, take a few minutes to practice guiding. Set the hand control slew rate to an appropriate slew rate and practice centering the guide star in the cross hairs for several minutes. This will help you familiarize yourself with the periodic error of the drive and the operation of the hand control. Remember to ignore declination drift when programming the PEC.
5. To begin recording the drive's periodic error, press the **MENU** => “**PEC Option**” => “**Record PEC**”. Once ready to begin recording, press the **ENTER** button to begin. Use the arrow button to keep the guiding star staying at the center of the cross hairs. It takes the worm gear 600 seconds to make one complete revolution. After 600 seconds PEC will automatically stop recording.
6. If you want to re-record the periodic error, select “**Record PEC**” and repeat the recording processes again. The previously recorded information will be replaced with the current information.
7. The PE data needs be recorded again if the power is lost.

### 5.6.3. PEC Data Integrity

This function will check the recorded PEC data integrity.

## 5.7. Edit User Objects

Besides various star lists available in the hand controller, you can add, edit or delete your own user-defined objects. This is especially useful for newly found comets. You can also add your favorite observation object into the user object list for easy sky surfing. Up to 60 comets and other user objects can be stored.

### 5.7.1. Enter a New Comet

Press **MENU** => "**Edit User Objects**" to set user objects.

```
User Defined Comet
Other Objects
```

Select "**User Defined Comet**" to add/browse/delete the user-defined comet list. Find the orbit parameters of a comet in the SkyMap format. For example, the C/2012 ISON has an orbit parameter:

No.	Name	Year	M	Day	q	e	$\omega$	$\Omega$	i	H	G
C/2012	S1 ISON	2013	11	28.7960	0.0125050	1.0000030	345.5088	295.7379	61.8570	6.0	4.0

Select "**Add a New Comet**" to add a new one:

```
Add a New Comet
Browse Comets
Delete a Comet
Clear All Comets
```

The hand controller will display the parameter entry screen:

```
Date: 2000-01-00.0000
q: 0.000000 e: 0.000000
 $\omega$ : 000.0000  $\Omega$ : 000.0000
i: 000.0000
```

Enter the parameters using the arrow buttons and number keys. Press **ENTER** and a confirmation screen will be displayed. Press **ENTER** again to store the object under the assigned user object number, or press **BACK** button to cancel.

### 5.7.2. Enter Other Objects or Observation List

Press **MENU** => "**Edit User Objects**" to set user objects.

```
User Defined Comet
Other Objects
```

Select "**Other Objects**" to enter you own object:

```
Add a New Object
Browse Objects
Delete an Object
Clear All Objects
```

Select “**Add a New Object**”. A screen will be displayed asking you to Enter R.A. and DEC coordinates:

```
Enter R.A. and DEC

R.A.: 00h00m00s
DEC: +00d00m00s
```

You may enter the R.A. and DEC coordinates of the object you want to store, and press **ENTER** to confirm.

A more useful application of this function is to store your favorite viewing objects before heading to the field. When the “**Enter R.A. and DEC**” screen appears, press the **MENU** button. It brings up the catalogs that you can select the object from. Follow the screen instructions to add your favorite objects. Press **BACK** button to go back one level.

Press the **BACK** button to go back to the object entry submenu. You may review the records or delete those that are no longer wanted. Press the **BACK** button to finish the operation. Now you can slew to your favorite stars from “**Custom Objects**” catalog using “**Select and Slew.**”

## 5.8. Firmware Information

This option will display the mount type, firmware version information for the hand controller (HC), R.A. board (RA), and DEC board (DEC).

## 5.9. Zero Position

### 5.9.1. Goto Zero Position

This moves your telescope to its Zero Position. When the power is turned on, the mount assumes the Zero Position. This is the reference point for alignment and GoTo functions.

### 5.9.2. Set Zero Position

This set the Zero Position for the firmware.

The Zero Position reference will be an undefined value before the first time power on the mount, after firmware upgrade, or HC battery replacement. You can use this function to set the zero position reference.

Press the **ENTER** after moving the mount to Zero Position either manually or with the hand controller.

## 6. Maintenance and Servicing

### 6.1. Maintenance

Do not overload the mount. Do not drop the mount as this will damage the mount and / or permanently degrade GoTo performance and tracking accuracy. Use a wet cloth to clean the mount and hand controller. Do not use solvent.

The mount worm/gear meshing can be adjusted to accommodate payload or temperature changed. Please refer to the instruction in Appendix.

The real time clock battery in the hand controller needs be replaced if it can't keep the time after power off the mount.

If your mount is not to be used for an extended period, dismount the OTAs and counterweight(s).

### 6.2. iOptron Customer Service

If you have any question concerning your mount, please contact iOptron Customer Service Department. It is strongly suggested to send technical questions to [support@ioptron.com](mailto:support@ioptron.com) for prompt response during off hour. Customer Service hours are 9:00 AM to 5:00 PM, Eastern Time, Monday through Friday. Call in the U.S. 1.781.569.0200.

In the unlikely event that the mount requires factory servicing or repairing, write or call iOptron Customer Service Department first to receive a RMA# before returning the mount to the factory. Please provide details as to the nature of the problem as well as your name, address, e-mail address, purchase info and daytime telephone number. We have found that most problems can be resolved by e-mails or telephone calls. So please contact iOptron first to avoid returning the mount for repair.

### 6.3. Product End of Life Disposal Instructions



This electronic product is subject to disposal and recycling regulations that vary by country and region. It is your responsibility to recycle your electronic equipment per your local environmental laws and regulations to ensure that it will be recycled in a manner that protects human health and the environment. To find out where you can drop off your waste equipment for recycling, please contact your local waste recycle/disposal service or the product representative.

### 6.4. Battery Replacement and Disposal Instructions



Battery Disposal- Batteries contain chemicals that, if released, may affect the environment and human health. Batteries should be collected separately for recycling, and recycled at a local hazardous material disposal location adhering to your country and local government regulations. To find out where you can drop off your waste battery for recycling, please contact your local waste disposal service or the product representative.

## Appendix A. Technical Specifications

Mount	German Equatorial Mount (GEM)
Payload*	Up to 28 lb (12.7kg), exclude counterweight
Mount weight	10 lb (4.5kg)
Payload/Mount weight	2.80
Structure Material	All metal, Casting + CNC machined
Periodic Error (PE)**	<±10 arcsec for GEM28 <0.3 arcsec rms for GEM28EC
PEC	Permanent PEC/Real-time PEC
Right Ascension worm wheel	Φ88mm, 144 teeth aluminum
Declination worm wheel	Φ88mm, 144 teeth aluminum
Right Ascension axis shaft	Φ35mm steel
Declination axis shaft	Φ35mm steel
Right Ascension bearing	Φ55mm ball bearing
Declination bearing	Φ55mm ball bearing
Worm gears	Φ15.2mm, brass
Motor drive	1.8° stepper motor, 128X microdivision
Resolution	0.17 arc seconds
Transmission	Synchronous belt
Latitude adjustment range	0° ~ 60°
Azimuth adjustment range	± 6°
Polar Scope	iPolar™ electronic polar scope or AccuAlign™ dark field illuminated optical polar scope
Level indicator	Level bubble
Hand Controller	Go2Nova® 8409 with 212,000 objects database
Tracking	Automatic
Speed	1x,2x,8x,16x,64x,128x,256x,512x,MAX(6°/sec)
Power consumption	0.5A(Tracking), 0.8A(GOTO)
Power requirement	12V, 5A
AC adapter	100V ~ 240V (included)
Wi-Fi	Built-in
Communication port	Yes (USB and Wi-Fi)
Autoguide port	Yes (ST-4 compatible)
Firmware upgrade	Yes
PC computer control	Yes
Dovetail saddle	3.8" spring loaded Vixen-style, center adjustable
Counterweight shaft	Φ20mm X306mm (M16)
Counterweight	10 lb (4.5kg)
Tripod	1.5" Stainless Steel(5kg), or LiteRoc™ 1.75"(7.5kg)
GPS	Optional external 32-channel GPS
Autoguider	Optional external iGuider
Operation temperature	-10°C ~ 40°C
Warranty	Two year limited

\* OTA size and length dependent, smaller than 6" in diameter recommended.

\*\* Measured with encoder on bench, 10 minutes



# Appendix B. Go2Nova<sup>®</sup> 8409 HC MENU STRUCTURE

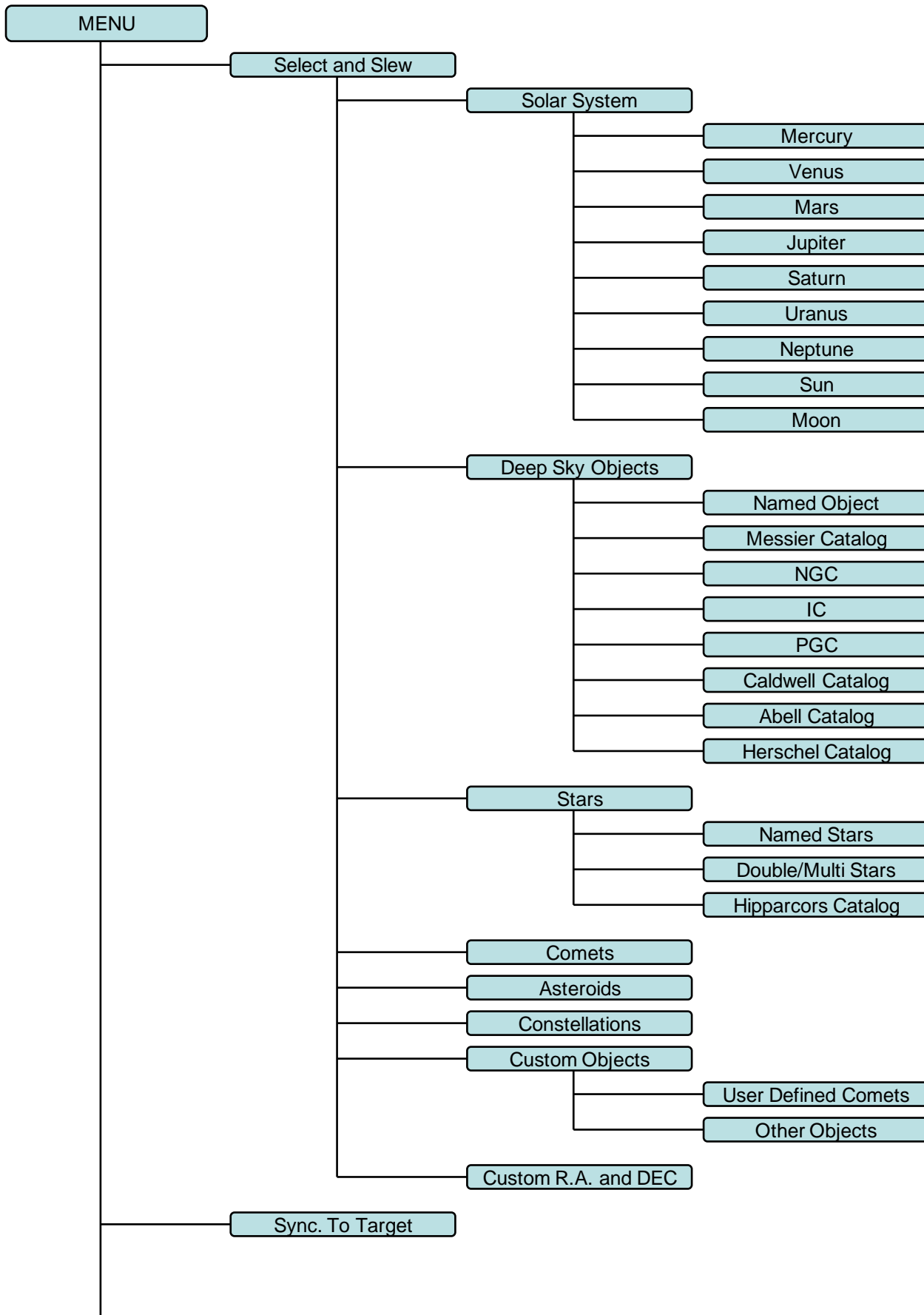

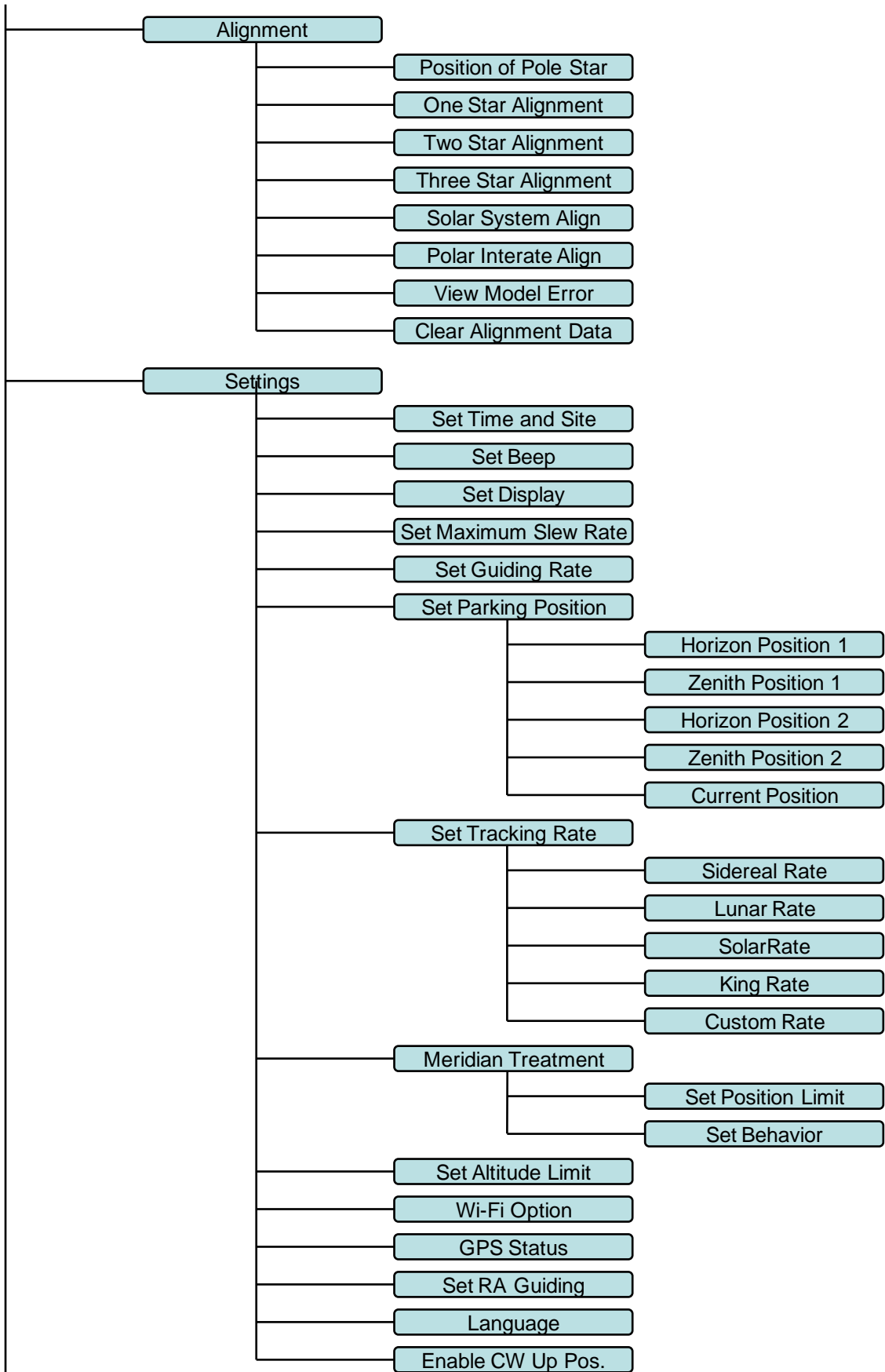

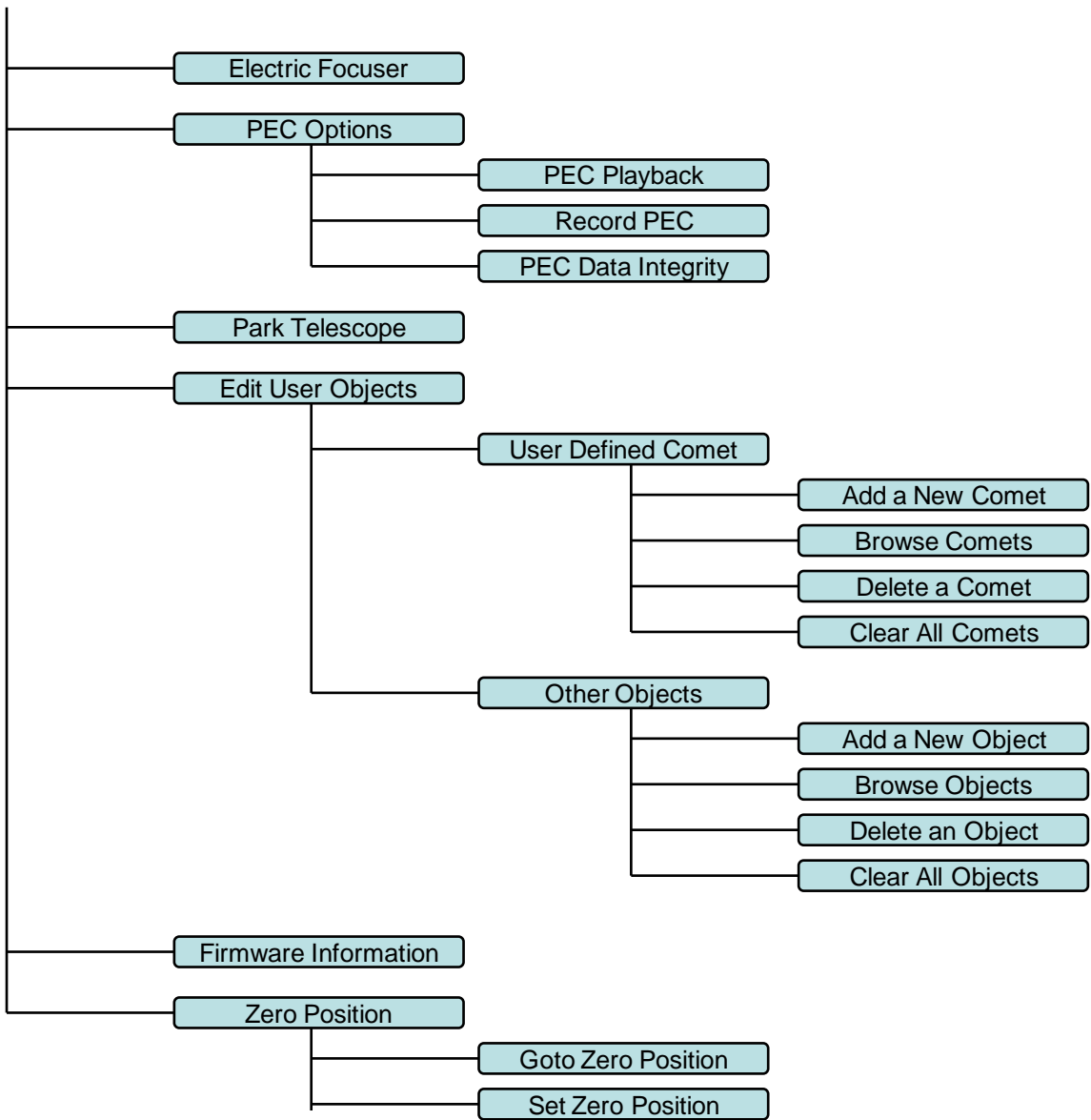

Some functions are mount dependent.

## Appendix C. Gear Meshing Adjustment

CEM26/GEM28 gear is designed adjustable by customer although in most cases not necessary. If you experienced DEC/RA motor stall occasionally, or there is free play between the worm and gear, follow this instruction to adjust the gear meshing.

**Tool needed:** 2mm and 3mm hex keys.

### To Adjust DEC Gear:

Disengage DEC gear switch. Rotate DEC saddle to exposure the small hole (3mm in diameter) that is blocked by the dovetail saddle. Another larger hole (5mm) is located on the side of the DEC gear housing. There is a **set screw** inside the 3mm hole to lock the **gear meshing adjustment plunger**, which is inside the larger hole.

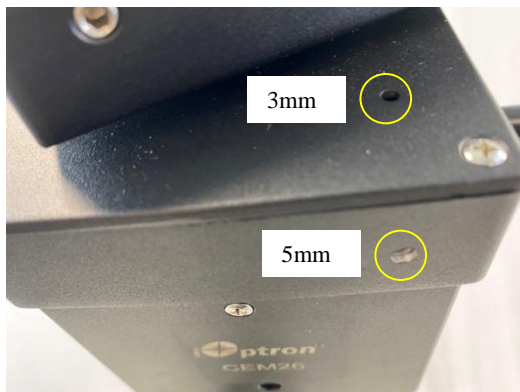

Engage the worm/gear by turn the gear switch to locking position.



Insert the 2mm hex key into the small hole on the top. Gently turn the hex key until you feel it is engaged to the set screw inside. You may turn the gear switch further in the lock position if the wrench can't engage the set screw. Turn the **set screw** half a turn counterclockwise to release it.



Adjust the **gear meshing adjustment plunger** on the side inside the large hole by using the 3mm hex key. Turn counterclockwise to loosen the meshing or turn clockwise to tighten the meshing.

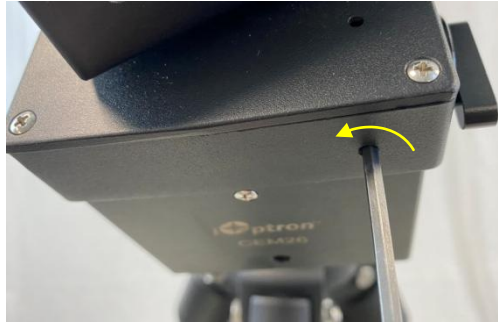

If the motor stalls or the mount does not tracking smoothly, most likely the meshing is too tight. You may loosen it by about 1/8 turn (or less for tracking).

***Tighten the set screw in the small hole to LOCK the gear screw (important) before test the mount.***

Adjust again if needed, but no more than ¼ turn in total.

If you feel there is free play between the worm and gear, you may tighten the meshing adjustment plunger to eliminate it.

### **To Adjust RA Gear:**

The RA gear meshing adjustment plunger is located next to the RA Gear Switch. The adjustment is same as that for DEC gear/worm.

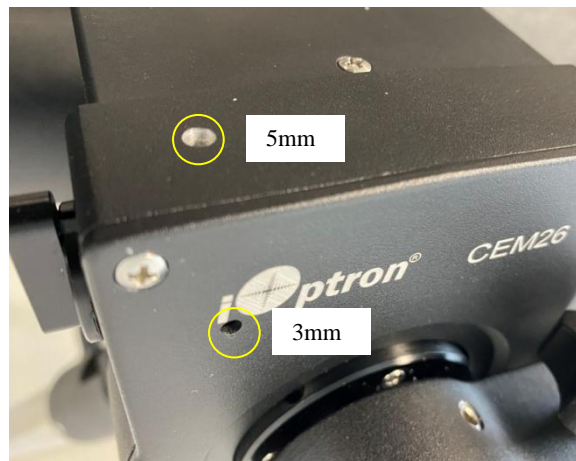

**DO NOT over tighten the gear meshing adjustment plunger to avoid damage it.**

## Appendix D. Firmware Upgrade

The firmware in the 8409 hand controller and motor control boards can be upgraded by the customer. Please check iOptron's website, [www.iOptron.com](http://www.iOptron.com), under the product page or Support Directory.

## Appendix E. Computer Control an GEM28 Mount

The GEM28 mount can be controlled by a SmartPhone, a Tablet or a computer. It is supported by two types of computer connections:

- Connect to a computer via USB port on hand controller. The mount can be controlled via ASCOM protocol (Windows OS), or directly by some software, such as Sky Safari (Mac OS)
- Connect wirelessly via built-in wireless connection. The mount can be controlled via ASCOM protocol (Windows OS), SmartPhone/Tablet and Mac OS wirelessly.

To control the mount via ASCOM protocol, you need:

1. Download and install the latest ASCOM Platform from <http://www.ascom-standards.org/>. Make sure your PC meets the software requirement.
2. Download and install the latest iOptron Commander/ASCOM drive for GEM28 from iOptron website. The GEM28 uses Commander for a CEM120/CEM70/CEM26/GEM28 mount.
3. Planetarium software that supports ASCOM protocol. Follow software instructions to select the iOptron Telescope.

Please refer to iOptron website, [www.iOptron.com](http://www.iOptron.com), under the product page, or Support Directory, iOptron ASCOM Driver for more detail.

# Appendix F. Go2Nova<sup>®</sup> Star List

## Named Deep Sky Object

1	47 Tucanae	47	Integral Sign Galaxy
2	Andromeda Galaxy	48	Iris Nebula
3	Antennae Galaxies	49	Jellyfish Nebula
4	Barnard's Galaxy	50	Jewel Box Cluster
5	Bear-Paw Galaxy	51	Lagoon Nebula
6	Beehive Cluster	52	Lambda Centauri Nebula
7	Black Eye Galaxy	53	Large Magellanic Cloud
8	Blinking Planetary	54	Leo Triplet
9	Blue Flash Nebula	55	Little Dumbbell Nebula
10	Blue Planetary	56	Little Gem Nebula
11	Blue Snowball Nebula	57	Little Ghost Nebula
12	Bode's Galaxy	58	Mice Galaxies
13	Box Nebula	59	Monkey Head Nebula
14	Bubble Nebula	60	North America Nebula
15	Bug Nebula	61	Northern Jewel Box
16	Butterfly Cluster	62	Omega Nebula
17	Butterfly Galaxies	63	Orion Nebula
18	California Nebula	64	Owl Nebula
19	Carina Nebula	65	Pacman Nebula
20	Cat's Eye Nebula	66	Pelican Nebula
21	Cave Nebula	67	Phantom Streak Nebula
22	Christmas Tree Cluster	68	Pinwheel Galaxy
23	Cigar Galaxy	69	Pleiades
24	Cocoon Nebula	70	Ring Nebula
25	Coma Pinwheel	71	Rosette Nebula
26	Copeland Septet	72	Saturn Nebula
27	Crab Nebula	73	Sextans B
28	Crescent Nebula	74	Small Magellanic Cloud
29	Draco Dwarf Galaxy	75	Sombrero Galaxy
30	Dumbbell Nebula	76	Soul Nebula
31	Eagle Nebula	77	Southern Pinwheel Galaxy
32	Eight-Burst Nebula	78	Spindle Galaxy(3115)
33	Elephant Trunk Nebula	79	Spindle Galaxy(5866)
34	Eskimo Nebula	80	Stephan's Quintet
35	Eyes Galaxies	81	Sunflower Galaxy
36	Flame Nebula	82	Tarantula Nebula
37	Flaming Star Nebula	83	The Witch Head Nebula
38	Ghost of Jupiter	84	The Wizard Nebula
39	Heart Nebula	85	Thor's Helmet
40	Helix Nebula	86	Triangulum Galaxy
41	Hercules Globular Cluster	87	Trifid Nebula
42	Hind's Variable Nebula	88	Ursa Minor Dwarf Galaxy
43	Hockey Stick Galaxies	89	Veil Nebula
44	Horsehead Nebula	90	Whale Galaxy
45	Hubble's Variable Nebula	91	Whirlpool Galaxy
46	Hyades Cluster	92	Wild Duck Cluster



# Messier Catalog

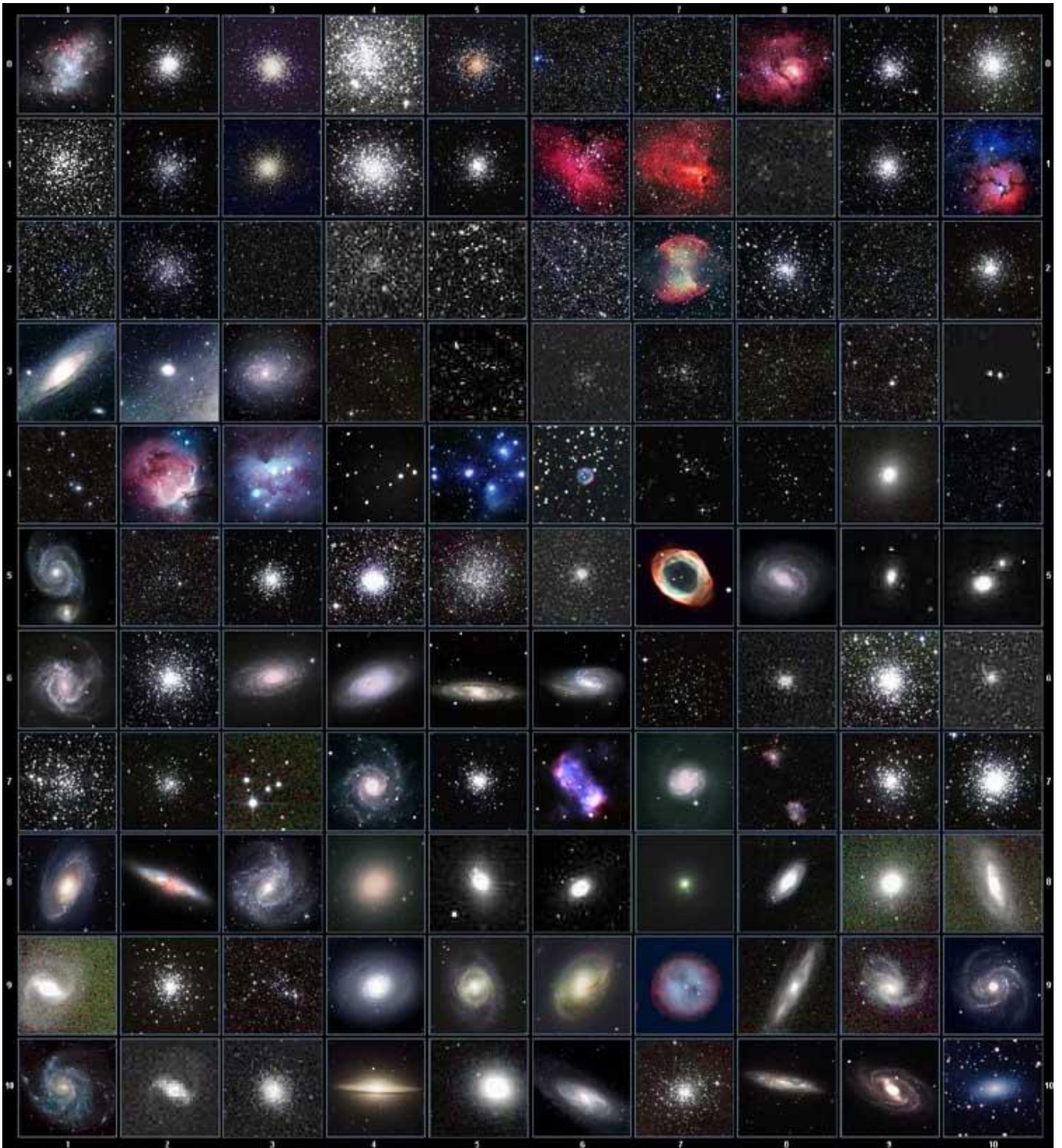

This table is licensed under the [GNU Free Documentation License](#). It uses material from the [Wikipedia article List of Messier objects](#)

## Named Star

1	Acamar	50	Alrescha	99	Deneb el Okab	148	Lalande 21185
2	Achernar	51	Alshain	100	Deneb Kaitos	149	Lesath
3	Achird	52	Altair	101	Denebakrab	150	Mahasim
4	Acrab	53	Altais	102	Denebola	151	Maia
5	Acrux A	54	Alterf	103	Dschubba	152	Marfik
6	Acrux B	55	Aludra	104	Dubhe	153	Marfikent
7	Acubens	56	Alula Australis	105	Edasich	154	Markab
8	Adhafera	57	Alula Borealis	106	El Rehla	155	Markeb
9	Adhara	58	Alya	107	Electra	156	Matar
10	Adid Australis	59	Ancha	108	Elnath	157	Mebсутa
11	Ahadi	60	Ankaa	109	Eltanin	158	Megrez
12	Al Dhanab	61	Antares	110	Enif	159	Meissa
13	Al Dhibain Prior	62	Apollyon	111	Errai	160	Mekbuda
14	Al Kab	63	Arcturus	112	Fomalhaut	161	Menkalinan
15	Al Nair	64	Arkab Prior	113	Furud	162	Menkar
16	Al Nair al Baten	65	Arneb	114	Gacrux	163	Menkent
17	Al Niyat(Sigma)	66	Ascella	115	Gatria	164	Menkib
18	Al Niyat(Tau)	67	Asellus Austral	116	Giausar	165	Merak
19	Albaldah	68	Asellus Boreali	117	Gienah Cori	166	Merope
20	Albali	69	Aspidiske	118	Gienah Cygni	167	Mesartim
21	Albireo	70	Atik	119	Girtab	168	Miaplacidus
22	Alchiba	71	Atlas	120	Gliese 1	169	Mimosa
23	Alcor	72	Atria	121	Gomeisa	170	Mintaka
24	Alcyone	73	Arior	122	Graffias(Zeta)	171	Mira
25	Aldebaran	74	Azha	123	Groombridge 1830	172	Mirach
26	Alderamin	75	Barnard's Star	124	Gruid	173	Mirfak
27	Alfirk	76	Baten Kaitos	125	Grumium	174	Mirzam
28	Algenib	77	Beid	126	Hadar	175	Mizar
29	Algenubi	78	Bellatrix	127	Hamal	176	Mu Velorum
30	Algieba	79	Beta Hydri	128	Han	177	Muhlifain
31	Algiedi Secunda	80	Betelgeuse	129	Hatsya	178	Muphrid
32	Algol	81	Betria	130	Head of Hydrus	179	Muscida
33	Algorab	82	Biham	131	Homam	180	Naos
34	Alhakim	83	Birdun	132	Iritjinga(Cen)	181	Nashira
35	Alhena	84	Canopus	133	Izar	182	Navi
36	Alioth	85	Capella	134	Kakkab Su-gub Gud-Elim	183	Nekkar
37	Alkaid	86	Caph	135	Kapteyn's Star	184	Nihal
38	Alkalurops	87	Castor A	136	Kaus Australis	185	Nunki
39	Alkes	88	Castor B	137	Kaus Borealis	186	Nusakan
40	Almaaz	89	Cebalrai	138	Kaus Media	187	Palida
41	Almach	90	Chara	139	Keid	188	Peacock
42	Alnasi	91	Chertan	140	Kekouan	189	Phact
43	Alnilam	92	Choo	141	Kitalpha	190	Phecda
44	Alnitak	93	Cor Caroli	142	Kochab	191	Pherkad
45	Alpha Muscae	94	Cursa	143	Koo She	192	Polaris
46	Alpha Tucanae	95	Dabih	144	Kornephoros	193	Pollux
47	Alphard	96	Deltotum	145	Kraz	194	Porrima
48	Alphecca	97	Deneb	146	Kurhah	195	Procyon
49	Alpheratz	98	Deneb Algedi	147	Lacaille 9352	196	Propus

197	Proxima Centauri	213	Sadalbari	229	Sulafat	245	Vindemiatrix
198	Rasalas	214	Sadalmelik	230	Syrma	246	Vrischika
199	Rasalgethi	215	Sadalsuud	231	Talitha	247	Wasat
200	Rasalhague	216	Sadr	232	Tania Australis	248	Wazn
201	Rastaban	217	Saiph	233	Tania Borealis	249	Wei
202	Regor	218	Sargas	234	Tarazed	250	Wezen
203	Regulus	219	Scheat	235	Taygeta	251	Yed Posterior
204	Rigel	220	Schedar	236	Tejat Posterior	252	Yed Prior
205	Rigel Kentaurus A	221	Seginus	237	Thuban	253	Zaniah
206	Rigel Kentaurus B	222	Shaula	238	Thusia	254	Zaurak
207	Ruchbah	223	Sheliak	239	Tien Kwan	255	Zavijava
208	Rukbat	224	Sheratan	240	Turais	256	Zeta Persei
209	Rukh	225	Sirius	241	Unukalhai	257	Zosma
210	Rutilicus	226	Skat	242	Vasat-ul-cemre	258	Zubenelgenubi
211	Sabik	227	Spica	243	Vathorz Posterior	259	Zubeneschamali
212	Sadachbia	228	Suhail	244	Vega		

## Modern Constellations

No.	Constellation	Abbreviation
1	Andromeda	And
2	Antlia	Ant
3	Apus	Aps
4	Aquarius	Aqr
5	Aquila	Aql
6	Ara	Ara
7	Aries	Ari
8	Auriga	Aur
9	Boötes	Boo
10	Caelum	Cae
11	Camelopardalis	Cam
12	Cancer	Cnc
13	Canes Venatici	CVn
14	Canis Major	CMa
15	Canis Minor	CMi
16	Capricornus	Cap
17	Carina	Car
18	Cassiopeia	Cas
19	Centaurus	Cen
20	Cepheus	Cep
21	Cetus	Cet
22	Chamaeleon	Cha
23	Circinus	Cir
24	Columba	Col
25	Coma Berenices	Com
26	Corona Australis	CrA
27	Corona Borealis	CrB
28	Corvus	Crv
29	Crater	Crt
30	Crux	Cru
31	Cygnus	Cyg
32	Delphinus	Del
33	Dorado	Dor
34	Draco	Dra
35	Equuleus	Equ
36	Eridanus	Eri
37	Fornax	For
38	Gemini	Gem
39	Grus	Gru
40	Hercules	Her
41	Horologium	Hor
42	Hydra	Hya
43	Hydrus	Hyi
44	Indus	Ind

No.	Constellation	Abbreviation
45	Lacerta	Lac
46	Leo	Leo
47	Leo Minor	LMi
48	Lepus	Lep
49	Libra	Lib
50	Lupus	Lup
51	Lynx	Lyn
52	Lyra	Lyr
53	Mensa	Men
54	Microscopium	Mic
55	Monoceros	Mon
56	Musca	Mus
57	Norma	Nor
58	Octans	Oct
59	Ophiuchus	Oph
60	Orion	Ori
61	Pavo	Pav
62	Pegasus	Peg
63	Perseus	Per
64	Phoenix	Phe
65	Pictor	Pic
66	Pisces	Psc
67	Piscis Austrinus	PsA
68	Puppis	Pup
69	Pyxis	Pyx
70	Reticulum	Ret
71	Sagitta	Sge
72	Sagittarius	Sgr
73	Scorpius	Sco
74	Sculptor	Scl
75	Scutum	Sct
76	Serpens	Ser
77	Sextans	Sex
78	Taurus	Tau
79	Telescopium	Tel
80	Triangulum	Tri
81	Triangulum Australe	TrA
82	Tucana	Tuc
83	Ursa Major	UMa
84	Ursa Minor	UMi
85	Vela	Vel
86	Virgo	Vir
87	Volans	Vol
88	Vulpecula	Vul

## Double/Multi Stars

No.	HC Item		Constellation	Name	HIP	WDS	SAO
1	Rigel Kentaurus A	Alpha Centauri	Centaurus		71683	14396-6050	252838
2	Rigel	Beta Orionis	Orion		24436	05145-0812	131907
3	Gacrux	Gamma Crucis	Crux		61084	12312-5707	240019
4	Sargas	Theta Scorpii	Scorpius		86228	17373-4300	228201
5	Castor A	Alpha Geminorum	Gemini		36850	07346+3153	60198
6	Mizar	Zeta Ursae Majoris	Ursa Major		65378	13239+5456	28737
7	Almach	Gamma Andromedae	Andromeda		9640	02039+4220	37735
8	Algieba	Gamma Leonis	Leo		50583	10200+1950	81298
9	Aludra	Eta Canis Majoris	Canis Major		35904	07241-2918	173651
10	Iritjinga (Cen)	Gamma Centauri	Centaurus	Muhlifain	61932	12415-4858	223603
11	Zubenelgenubi	Alpha Librae	Libra		72603	14509-1603	158836
12	Alcyone	Eta Tauri	Taurus		17702	03475+2406	76199
13	Cor Caroli	Alpha Canum Venaticorum	Canes Venatici		63125	12560+3819	63257
14	Acamar	Theta Eridani	Eridanus		13847	02583-4018	216113
15	Adhafera	Zeta Leonis	Leo		50335	10167+2325	81265
16	Rasalgethi	Alpha Herculis	Hercules		84345	17146+1423	102680
17	Meissa	Lambda Orionis	Orion		26207	05351+0956	112921
18	Graffias	Beta1 Scorpii	Scorpius		78820	16054-1948	159682
19	Alya	Theta Serpentis	Serpens		92946	18562+0412	124068
20	HIP 48002	Upsilon Carinae	Carina	Vathorz Prior		09471-6504	250695
21	HIP 95947	Beta1 Cygni	Cygnus	Albireo		19307+2758	87301
22	HIP 20894	Theta2 Tauri	Taurus			04287+1552	93957
23	HIP 74395	Zeta Lupi	Lupus			15123-5206	242304
24	HIP 27072	Gamma Leporis	Lupus			05445-2227	170759
25	HIP 26549	Sigma Orionis	Orion			05387-0236	132406
26	HIP 85667	HD 158614	Ophiuchus			17304-0104	141702
27	HIP 74376	Kappa1 Lupi	Lupus			15119-4844	225525
28	HIP 34481	Gamma2 Volantis	Carina			07087-7030	256374
29	HIP 53253	Upsilon Carinae	Carina			10535-5851	238574
30	HIP 99675	Omicron1 Cygni	Cygnus	31 Cyg		20136+4644	49337
31	HIP 63003	Mu1 Crucis	Crux			12546-5711	240366
32	HIP 43103	Iota Cancri	Cancer	48 Cnc		08467+2846	80416
33	HIP 110991	Delta Cephei	Cepheus	27 Cep		22292+5825	34508
34	HIP 20635	Kappa1 Tauri	Taurus	65 Tau		04254+2218	76601
35	HIP 88601	70 Ophiuchi	Orion			18055+0230	123107
36	HIP 2484	Beta1 Tucanae	Horologium			00315-6257	248201
37	HIP 91971	Zeta1 Lyrae	Cygnus	6 Lyr		18448+3736	67321
38	HIP 79374	Nu Scorpii	Scorpius	Jabbah		16120-1928	159764
39	HIP 102532	Gamma2 Delphini	Pegasus	12 Del		20467+1607	106476
40	HIP 52154	Xi Velorum	Vela			10393-5536	238309
41	HIP 37229	HD 61555	Canis Major			07388-2648	174198
42	HIP 30419	Epsilon Monocerotis	Orion	8 Mon		06238+0436	113810
43	HIP 108917	Xi Cephei	Cepheus	Al kurhah		22038+6438	19827
44	HIP 53417	54 Leonis	Leo			10556+2445	81584
45	HIP 65271	J Centauri	Centaurus			13226-6059	252284
46	HIP 67669	3 Centauri	Centaurus			13518-3300	204916
47	HIP 105319	Theta Indi	Indus			21199-5327	246965
48	HIP 80582	Epsilon Normae	Norma			16272-4733	226773
49	HIP 8832	Gamma Arietis	Aries			01535+1918	92680
50	HIP 69483	Kappa Boötis	Boötes	Asellus Tertius		14135+5147	29045
51	HIP 92946	Theta Serpentis	Serpens			18562+0412	124068
52	HIP 86614	Psi1 Draconis	Draco	31 Draconis		17419+7209	8890

No.	HC Item		Constellation	Name	HIP	WDS	SAO
53	HIP 95771	Alpha Vulpeculae	Vulpecula	Anser		19287+2440	87261
54	HIP 30867	Beta Monocerotis	Monoceros			06288-0702	133316
55	HIP 35363	NV Puppis	Puppis			07183-3644	197824
56	HIP 94761	Gliese 752	Aquila	Wolf 1055, Ross 652		19169+0510	
57	HIP 21683	Sigma2 Tauri	Taurus			04393+1555	94054
58	HIP 8497	Chi Ceti	Cetus	53 Cet		01496-1041	148036
59	HIP 26199	HD 36960	Orion			05350-0600	132301
60	HIP 104521	Gamma Equulei	Equuleus	5 Equ		21103+1008	126593
61	HIP 116389	Iota Phoenicis	Phoenix			23351-4237	231675
62	HIP 17797	HD 24071	Eridanus			03486-3737	194550
63	HIP 21036	83 Tauri	Taurus			04306+1343	93979
64	HIP 107310	Mu1 Cygni	Cygnus	78 Cyg		21441+2845	89940
65	HIP 72659	Xi Boötis	Boötes	37 Boo		14514+1906	101250
66	HIP 21029	HD 28527	Taurus			04306+1612	93975
67	HIP 42726	HY Velorum	Vela			08424-5307	236205
68	HIP 18255	32 Eridani	Eridanus			03543-0257	130806
69	HIP 9153	Lambda Arietis	Aries			01580+2336	75051
70	HIP 88267	95 Herculis	Hercules			18015+2136	85648
71	HIP 85829	Nu2 Draconis	Draco	25 Dra		17322+5511	30450
72	HIP 43937	V376 Carinae	Carina	b1 Carinae		08570-5914	236436
73	HIP 71762	Pi2 Boötis	Boötes	29 Boo		14407+1625	101139
74	HIP 80047	Delta1 Apodis	Apus			16203-7842	257380
75	HIP 58484	Epsilon Chamaeleontis	Chamaeleon			11596-7813	256894
76	HIP 25142	23 Orionis	Orion			05228+0333	112697
77	HIP 54204	Chi1 Hydrae	Hydra			11053-2718	179514
78	HIP 76669	Zeta Coronae Borealis	Corona Borealis	7 CrB		15394+3638	64833
79	HIP 99770	b3 Cygni	Cygnus	29 Cyg		20145+3648	69678
80	HIP 101027	Rho Capricorni	Capricornus	11 Cap		20289-1749	163614
81	HIP 74911	Nu Lupi	Lupus			15185-4753	225638
82	HIP 35210	HD 56577	Canis Major			07166-2319	173349
83	HIP 26235	Theta2 Orionis	Orion	43 Ori		05354-0525	132321
84	HIP 40321	OS Puppis	Puppis			08140-3619	198969
85	HIP 70327	HD 126129	Boötes			14234+0827	120426
86	HIP 26221	Theta1 Orionis	Orion	Trapezium		05353-0523	132314
87	HIP 80473	Rho Ophiuchi	Ophiuchus	5 Oph		16256-2327	184381
88	HIP 78105	Xi1 Lupi	Lupus			15569-3358	207144
89	HIP 79043	Kappa Herculis	Hercules	7 Her		16081+1703	101951
90	HIP 61418	24 Comae Berenices	Coma Berenices			12351+1823	100160
91	HIP 91919	Epsilon Lyrae	Lyra	4 Lyr		18443+3940	67309
92	HIP 41639	HD 72127	Vela			08295-4443	219996
93	HIP 104214	61 Cygni	Cygnus			21069+3845	70919
94	HIP 23734	11 Camelopardalis	Camelopardalis			05061+5858	25001
95	HIP 60189	Zeta Corvi	Corvus	5 Crv		12206-2213	180700
96	HIP 66821	Q Centauri	Centaurus			13417-5434	241076
97	HIP 14043	HD 18537	Perseus			03009+5221	23763
98	HIP 5737	Zeta Piscium	Pisces	86 Psc		01137+0735	109739
99	HIP 84626	Omicron Ophiuchi	Ophiuchus	39 Oph		17180-2417	185238
100	HIP 60904	17 Comae Berenices	Coma Berenices			12289+2555	82330
101	HIP 58684	67 Ursae Majoris	Ursa Major			12021+4303	44002
102	HIP 5131	Psi1 Piscium	Pisces	74 Psc		01057+2128	74482
103	HIP 115126	94 Aquarii	Aquarius			23191-1328	165625
104	HIP 62572	HD 112028	Camelopardalis			12492+8325	2102

No.	HC Item		Constellation	Name	HIP	WDS	SAO
105	HIP 40167	Zeta1 Cancri	Cancer	Tegmen		08122+1739	97645
106	HIP 40817	Kappa Volantis	Volans			08198-7131	256497
107	HIP 81292	17 Draconis	Draco			16362+5255	30013
108	HIP 80197	Nu1 Coronae Borealis	Corona Borealis			16224+3348	65257
109	HIP 88060	HD 163756	Sagittarius			17591-3015	209553
110	HIP 42637	Eta Chamaeleontis	Chamaeleon			08413-7858	256543
111	HIP 21039	81 Tauri	Taurus			04306+1542	93978
112	HIP 100965	75 Draconis	Draco			20282+8125	3408
113	HIP 25768	HD 36553	Pictor			05302-4705	217368
114	HIP 93717	15 Aquilae	Aquila			19050-0402	142996
115	HIP 79980	HD 148836	Scorpius			16195-3054	207558
116	HIP 12086	15 Trianguli	Triangulum			02358+3441	55687
117	HIP 90968	Kappa2 Coronae Australe	Corona Australis			18334-3844	210295
118	HIP 22531	Iota Pictoris	Pictor			04509-5328	233709
119	HIP 34065	HD 53705	Puppis			07040-4337	218421
120	HIP 79607	Sigma Coronae Borealis	Corona Borealis			16147+3352	65165
121	HIP 109786	41 Aquarii	Aquarius			22143-2104	190986
122	HIP 56280	17 Crateris	Hydra			11323-2916	179968
123	HIP 51561	HD 91355	Vela			10320-4504	222126
124	HIP 107930	HD 208095	Cepheus			21520+5548	33819
125	HIP 97966	57 Aquilae	Aquila			19546-0814	143898
126	HIP 117218	107 Aquarii	Aquarius.			23460-1841	165867
127	HIP 82676	HD 152234	Scorpius			16540-4148	227377
128	HIP 111546	8 Lacertae	Lacerta			22359+3938	72509
129	HIP 29151	HD 42111	Orion			06090+0230	113507
130	HIP 107253	79 Cygni	Cygnus			21434+3817	71643
131	HIP 88136	41 Draconis	Draco			18002+8000	8996
132	HIP 81702	HD 150136	Ara			16413-4846	227049
133	HIP 97423	HD 186984	Sagittarius			19480-1342	162998
134	HIP 30444	HD 45145	Columba			06240-3642	196774
135	HIP 66400	HD 118349	Hydra			13368-2630	181790
136	HIP 17579	21 Tauri	Taurus	Asterope		03459+2433	76159
137	HIP 35785	19 Lyncis	Lynx			07229+5517	26312
138	HIP 81641	37 Herculis	Hercules			16406+0413	121776
139	HIP 7751	rho Eridani	Eridanus			01398-5612	232490
140	HIP 21148	1 Camelopardalis	Camelopardalis			04320+5355	24672
141	HIP 9021	56 Andromedae	Andromeda			01562+3715	55107
142	HIP 97816	HD 187420	Telescopium			19526-5458	246311
143	HIP 88818	100 Herculis	Hercules			18078+2606	85753
144	HIP 36817	HD 60584	Puppis			07343-2328	174019
145	HIP 25695	HD 35943	Taurus			05293+2509	77200
146	HIP 98819	15 Sagittae	Sagitta			20041+1704	105635
147	HIP 61910	VV Corvi	Corvus			12413-1301	157447
148	HIP 111643	Sigma2 Gruis	Grus			22370-4035	231217
149	HIP 80399	HD 147722	Scorpius			16247-2942	184368
150	HIP 83478	HD 154228	Hercules			17037+1336	102564
151	HIP 101123	Omicron Capricorni	Capricornus			20299-1835	163626
152	HIP 28271	59 Orionis	Orion			05584+0150	113315
153	HIP 64246	17 Canum Venaticorum	Canes Venatici			13101+3830	63380
154	HIP 96895	16 Cygni	Cygnus			19418+5032	31898
155	HIP 35564	HD 57852	Carina			07204-5219	235110
156	HIP 37843	2 Puppis	Puppis			07455-1441	153363

No.	HC Item		Constellation	Name	HIP	WDS	SAO
157	HIP 28790	HD 41742	Puppis			06047-4505	217706
158	HIP 4675	HD 5788	Andromeda			01001+4443	36832
159	HIP 31676	8 Lyncis	Lynx			06377+6129	13897
160	HIP 10176	59 Andromedae	Andromeda			02109+3902	55330
161	HIP 25950	HD 36408	Taurus			05322+1703	94630
162	HIP 117931	AL Sculptoris	Sculptor			23553-3155	214860
163	HIP 81914	HD 150591	Scorpius			16439-4107	227123
164	HIP 21242	m Persei	Perseus			04334+4304	39604
165	HIP 86831	61 Ophiuchi	Ophiuchus			17446+0235	122690
166	HIP 115272	HD 220003	Grus			23208-5018	247838
167	HIP 46657	Zeta1 Antliae	Antlia			09308-3153	200444
168	HIP 41404	Phi2 Cancri	Cancer			08268+2656	80188
169	HIP 29388	41 Aurigae	Auriga			06116+4843	40925
170	HIP 49321	HD 87344	Hydra			10040-1806	155704
171	HIP 84054	63 Herculis	Hercules			17111+2414	84896
172	HIP 39035	HD 66005	Puppis			07592-4959	219249
173	HIP 25303	Theta Pictoris	Pictor			05248-5219	233965
174	HIP 52520	HD 93344	Carina			10443-7052	256750
175	HIP 95398	2 Sagittae	Sagitta			19244+1656	104797
176	UCAC4 277-135548						
177	HIP 32609	HD 48766	Lynx			06482+5542	25963
178	HIP 101765	48 Cygni	Cygnus			20375+3134	70287
179	HIP 24825	YZ Leporis	Lepus			05193-1831	150335
180	HIP 31158	21 Geminorum	Gemini			06323+1747	95795
181	HIP 3885	65 Piscium	Pisces			00499+2743	74295
182	HIP 93371	HD 176270	Australis			19011-3704	210816
183	HIP 36345	HD 59499	Puppis			07289-3151	198038
184	HIP 108364	HD 208947	Cepheus			21572+6609	19760
185	HIP 50939	HD 90125	Sextans			10242+0222	118278
186	HIP 76603	HD 139461	Libra			15387-0847	140672
187	HIP 32269	HD 49219	Carina			06442-5442	234683
188	HIP 42516	39 Cancri	Cancer			08401+2000	80333
189	HIP 62807	32 Comae Berenices	Coma Berenices			12522+1704	100309
190	UCAC4 226-128246						
191	HIP 94913	24 Aquilae	Aquila			19188+0020	124492
192	HIP 94336	HD 179958	Cygnus			19121+4951	48193
193	HIP 107299	HD 206429	Indus			21440-5720	247151
194	HIP 59984	HD 106976	Virgo			12182-0357	138704
195	HIP 16411	HD 21743	Taurus			03313+2734	75970
196	HIP 23287	HD 32040	Orion			05006+0337	112305
197	HIP 105637	HD 203857	Cygnus			21238+3721	71280
198	HIP 108925	HD 209744	Cepheus			22039+5949	34016
199	HIP 103814	HD 200011	Microscopium			21022-4300	230492
200	HIP 58112	65 Ursae Majoris	Ursa Major			11551+4629	43945
201	HIP 109354	V402 Lacertae	Lacerta			22093+4451	51698
202	HIP 43822	17 Hydrae	Hydra			08555-0758	136409
203	HIP 21986	55 Eridani	Eridanus			04436-0848	131442
204	HIP 17470	HD 23245	Taurus			03446+2754	76122
205	HIP 35960	V368 Puppis	Puppis			07248-3717	197974
206	HIP 42936	HD75086	Carina			08451-5843	236241
207	HIP 19272	SZ Camelopardalis	Camelopardalis			04078+6220	13031
208	HIP 76143	HD 138488	Libra			15332-2429	183565



## IOPTRON TWO YEAR TELESCOPE, MOUNT, AND CONTROLLER WARRANTY

A. iOptron warrants your telescope, mount, or controller to be free from defects in materials and workmanship for two years. iOptron will repair or replace such product or part which, upon inspection by iOptron, is found to be defective in materials or workmanship. As a condition to the obligation of iOptron to repair or replace such product, the product must be returned to iOptron together with proof-of-purchase satisfactory to iOptron.

B. The Proper Return Merchant Authorization Number must be obtained from iOptron in advance of return. Call iOptron at 1.781.569.0200 to receive the RMA number to be displayed on the outside of your shipping container. All returns must be accompanied by a written statement stating the name, address, and daytime telephone number of the owner, together with a brief description of any claimed defects. Parts or product for which replacement is made shall become the property of iOptron.

The customer shall be responsible for all costs of transportation and insurance, both to and from the factory of iOptron, and shall be required to prepay such costs.

iOptron shall use reasonable efforts to repair or replace any telescope, mount, or controller covered by this warranty within thirty days of receipt. In the event repair or replacement shall require more than thirty days, iOptron shall notify the customer accordingly. iOptron reserves the right to replace any product which has been discontinued from its product line with a new product of comparable value and function.

This warranty shall be void and of no force of effect in the event a covered product has been modified in design or function, or subjected to abuse, misuse, mishandling or unauthorized repair. Further, product malfunction or deterioration due to normal wear is not covered by this warranty.

IOPTRON DISCLAIMS ANY WARRANTIES, EXPRESS OR IMPLIED, WHETHER OF MERCHANTABILITY OF FITNESS FOR A PARTICULAR USE, EXCEPT AS EXPRESSLY SET FORTH HERE. THE SOLE OBLIGATION OF IOPTRON UNDER THIS LIMITED WARRANTY SHALL BE TO REPAIR OR REPLACE THE COVERED PRODUCT, IN ACCORDANCE WITH THE TERMS SET FORTH HERE. IOPTRON EXPRESSLY DISCLAIMS ANY LOST PROFITS, GENERAL, SPECIAL, INDIRECT OR CONSEQUENTIAL DAMAGES WHICH MAY RESULT FROM BREACH OF ANY WARRANTY, OR ARISING OUT OF THE USE OR INABILITY TO USE ANY IOPTRON PRODUCT. ANY WARRANTIES WHICH ARE IMPLIED AND WHICH CANNOT BE DISCLAIMED SHALL BE LIMITED IN DURATION TO A TERM OF TWO YEARS FROM THE DATE OF ORIGINAL RETAIL PURCHASE.

Some states do not allow the exclusion or limitation of incidental or consequential damages or limitation on how long an implied warranty lasts, so the above limitations and exclusions may not apply to you.

This warranty gives you specific legal rights, and you may also have other rights which vary from state to state.

iOptron reserves the right to modify or discontinue, without prior notice to you, any model or style telescope.

If warranty problems arise, or if you need assistance in using your telescope, mount, or controller contact:

iOptron Corporation  
Customer Service Department  
6E Gill Street  
Woburn, MA 01801  
[www.ioptron.com](http://www.ioptron.com)  
support@ioptron.com  
Tel. (781)569-0200  
Fax. (781)935-2860  
Monday-Friday 9AM-5PM EST

NOTE: This warranty is valid to U.S.A. and Canadian customers who have purchased this product from an authorized iOptron dealer in the U.S.A. or Canada or directly from iOptron. Warranty outside the U.S.A. and Canada is valid only to customers who purchased from an iOptron Distributor or Authorized iOptron Dealer in the specific country. Please contact them for any warranty.