

**doona™**

# doona™ +

## User Guide



Group 0+

Weight: 4-35 lbs (1.8-15.8 kg)

Height: 32 inches (81 cm) or less

Language: English



KEEP THIS USER GUIDE in its storage compartment at the back of the product.

# Table of Contents.

<b>01/ Safety Warnings</b> .....	7
<b>02/ Certifications</b> .....	10
<b>03/ Aircraft Installation</b> .....	11
<b>04/ Registration &amp; Recall</b> .....	12
<b>05/ Use Requirements</b> .....	13
<b>06/ Product Overview</b> .....	14
<b>07/ Use Modes</b> .....	18
7.1. Adjusting the rotation angle of the handle.....	19
7.2. Extending and retracting the handle.....	20
7.3. Rear wheels brakes.....	21
7.4. Changing between modes.....	21
<b>08/ Securing Your Child in the Doona Car Seat</b> .....	27
8.1. Infant Insert use.....	29
8.2. Head Support use.....	30
8.3. Harness use.....	32
8.4. Buckle use.....	36
8.5. Chest clip use.....	37
8.6. Shoulder strap pads adjustment.....	38
8.7. Securing your child with the harness.....	38

<b>09/ Selecting a Vehicle Seating Position</b> .....	40
<b>10/ Vehicle Seat Belts</b> .....	42
10.1 Compatible Vehicle Belts .....	42
10.2 Incompatible Vehicle Belts .....	45
<b>11/ Installing with a Base</b> .....	46
<b>12/ Installing without a Base</b> .....	47
12.1. Lap-Shoulder Belt European Installation (preferred).....	50
12.2. Lap-Shoulder Belt Standard Installation.....	53
12.3. Lap-Belt Installation.....	56
<b>13/ Care and Maintenance</b> .....	59
13.1. Sunshade Removal.....	60
13.2. Seat Pad Removal.....	61
13.3. Seat Pad Re-fitting.....	69
13.4. Sunshade Re-fitting.....	67
13.5. Cleaning the Seat Pad.....	71
13.6. Care for the harness straps \ harness buckle \ harness adjuster strap.....	72
13.7. Cleaning the Doona Car Seat accessories.....	72
13.8. Replacement parts.....	72
13.9. Storage.....	72
<b>14/ Accessories</b> .....	73
<b>15/ Two-Year Warranty</b> .....	74
<b>16/ Warranty Card</b> .....	75

# Congratulations.

Congratulations for choosing Doona's Car Seat as your child's safety and mobility solution.

In order to protect your child, the Doona Car Seat must always be used and installed as described in this user guide.

**IMPORTANT!** Keep this user guide for future use. Store in compartment at back of product. Read carefully before use.

Death or serious injury can occur if you do not follow these instructions and the instructions provided on the car seat.

Keep this user guide in the compartment located at the back of the Doona Car Seat.

If you have any questions regarding its use, feel free to contact your local distributor:

**SP DISTRIBUTION LLC.  
320 MIRACLE MILE, SUITE 201  
CORAL GABLES, FLORIDA 33134  
USA**

Customer Service:  
Tel: +1 (786) 542-6775  
E-mail: [info.usa@doona.com](mailto:info.usa@doona.com)

# 1 / Safety Warnings.

## **WARNING**

### **DEATH or SERIOUS INJURY can occur**

- Read all instructions on the car seat, in this user guide, and the instructions in your vehicle manual before using the Doona Car Seat.
- NEVER allow others to use or install the Doona Car Seat before they read the instructions in this user guide and the child restraint installation instructions in their vehicle manual.
- Use only in a rear-facing position when used in a vehicle.
- Always secure the Doona Car Seat in the vehicle with the vehicle belt or by attaching it to the Doona Base, secured with a vehicle belt or LATCH as instructed in the Doona Base user guide, even when not occupied. An unsecured Doona Car Seat can injure other occupants in the vehicle in the event of a crash or sudden stop.
- NEVER put your child in a used infant car seat unless you know its history. A seat may be damaged or have been in a severe crash and have damage that is difficult to see.
- DO NOT use accessories on the Doona Car Seat unless they are made by Simple Parenting and approved for use with the Doona Car Seat. Non-regulated parts and accessories may degrade the performance of the Doona Car Seat in case of a sharp turn, sudden stop, or a crash.

- DO NOT hang toys on the Doona Car Seat's handle.
- Use only with children who weigh between 4 lbs to 35 lbs (1.8 kg - 15.8 kg) or less and whose height is 32 inches (81 cm) or less.
- Snugly adjust the belts provided with the Doona Car Seat around your child.
- Secure the Doona Car Seat with the vehicle's child restraint anchorage system if available or with a vehicle belt.
- NEVER use the Doona Car Seat on a vehicle seat with an active frontal airbag!
- NEVER use the Doona Car Seat as a substitute for a bed or a cradle. The Doona Car Seat must only be used to transport a child.
- NEVER use the Doona Car Seat to transport more than one child.
- The Doona Car Seat is not suitable for use while running or skating.
- DO NOT USE the Doona Car Seat if it has been involved in a crash.
- DO NOT USE the Doona Car Seat if it is damaged or broken.
- DO NOT make any alterations or additions to the Doona Car Seat. Only the manufacturer is permitted to make modifications to the Doona Car Seat.

- Properly secure luggage or other objects in the vehicle that may cause serious injury or death in the event of a sharp turn, sudden stop or crash.
- NEVER leave your child in the Doona Car Seat in the vehicle. Vehicle interior temperatures can rise or drop to dangerous levels very quickly. Children have died from heat strokes or hyperthermia because they were left in a vehicle.
- DO NOT let your child play with the Doona Car Seat.
- Suffocation Hazard: an Infant carrier can roll over on soft surfaces and suffocate a child. NEVER place an infant carrier on beds, sofas, or other soft surfaces.
- Children have STRANGLED in loose or partially buckled harness straps. Fully restrain the child even when carrier is used outside the vehicle.
- Fall Hazard: Child's activity can move carrier. NEVER place carrier on counter tops, tables, or any other elevated surface.
- Avoid serious injury from falling or sliding out. Always use the harness.
- Placing or hanging packages on this product may cause it to become unstable and tip over.
- Always read warnings and instructions on the accessories provided with the Doona Car Seat before using them.

# 2/ Certifications.

## Aircraft approved.

**This Restraint is Certified for Use in Motor Vehicles and Aircraft.**

The Doona Car Seat conforms to all applicable Federal Motor Vehicle Safety Standards.



## Vehicle Types.

The Doona Car Seat is certified for use in all passenger cars, including SUV's, crossovers, vans, and light trucks.

## Registered patents.

US Patent No. 8,801,028

US Patent No. 8,469,390

US Patent No. 8,469,389

US Patent No. 8,434,781

US Patent No. 9,505,321



# 3 / Aircraft Installation.

Before arriving at the aircraft with the Doona Car Seat, please contact the airline regarding suitability and transport conditions in advance.

The use of the Doona Car Seat is allowed only on a plane with a 2-point seat belt.

Do not use the Doona Base on an aircraft, only the Doona carrier is certified for aircraft use.

For detailed instructions on installation and use of the Doona Car Seat in aircrafts, please refer to the instructions on securing the Doona Car Seat in your vehicle using the lap belt only, as described further in this user guide.

# 4 / Registration & Recall.

Child restraints could be recalled for safety reasons.

You must register this restraint to be reached in a recall. Send your name, address, email address if available, and the restraint's model number and manufacturing date to:

**SP DISTRIBUTION LLC.  
320 MIRACLE MILE, SUITE 201  
CORAL GABLES, FLORIDA 33134  
USA**

Or call Customer Service at +1 (786) 542-6775

Or register on-line at: [www.doona.com/register](http://www.doona.com/register)

For recall information, call the U.S. Government's Vehicle Safety Hotline at 1-888-327-4236 (TTY:1-800-424-9153), or go to <http://www.NHTSA.gov>

Also check the Doona website at:  
[www.doona.com](http://www.doona.com)

# 5 / Use Requirements.

For rear-facing use only.

Use the Doona Car Seat when your child meets all of the following criteria:

- Weight: 4 to 35 lbs (1.8 to 15.8 kg) and
- Height: 32 inches (81.3 cm) or less and
- When the top of the child's head is 1 inch (2.5 cm) or more below the top edge of the Doona Car Seat and
- When the shoulders are at or above the harness slot.

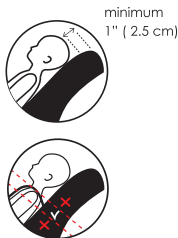

The American Academy of Pediatrics (AAP)

advises to keep children rear-facing until they reach the maximum height and weight as instructed on their car seat for rear facing use. Some states require children be kept rear-facing until 2 years of age. Check your local state law.

## **⚠ WARNING**

- Read this user guide carefully before attempting to secure your child in the Doona Car Seat. Incorrect installation may lead to **DEATH or SERIOUS INJURY**.
- Do not use the Doona Car Seat when your child's weight is over 35 lbs (15.8 kg), or if the top of the child's head is less than 1 inch (2.5 cm) from the top edge of the Doona Car Seat or if your child's height is over 32 inches (81.3 cm).

# 6 / Product Overview.

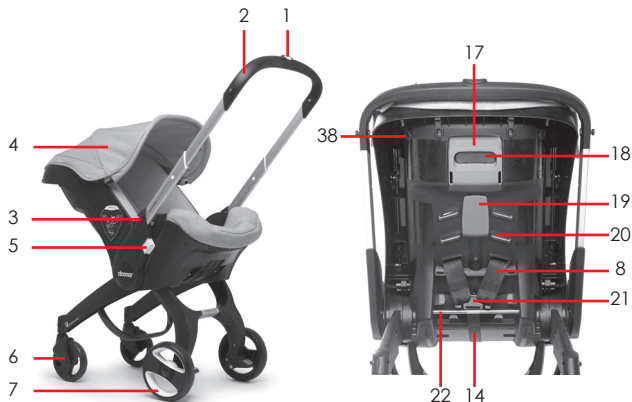

1. Handle extension button
2. Handle
3. Lap belt guides
4. Sunshade
5. Handle rotation buttons
6. Front wheels
7. Rear wheels

8. Shoulder straps
9. Buckle tongues
10. Buckle release button
11. Chest clip
12. Harness buckle
13. Harness adjustment button
14. Harness adjustment strap

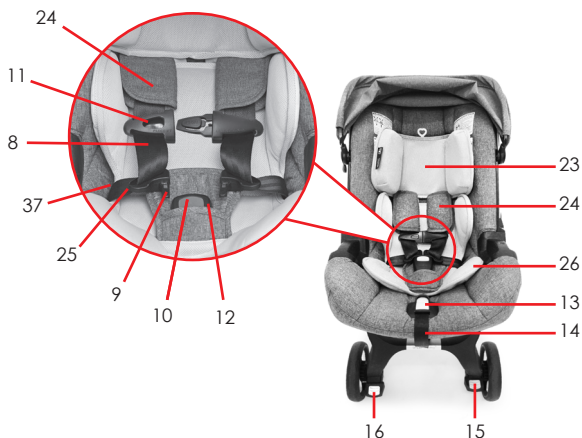

- 15. Brake lock pedal (red)
- 16. Brake release pedal (green)
- 17. Stroller wheel release
- 18. Safety lock
- 19. Vehicle shoulder belt guide
- 20. Shoulder strap slots
- 21. Metal harness plate

- 22. Metal bar
- 23. Head support
- 24. Shoulder strap pads
- 25. Lap straps
- 26. Infant insert



- 27. Vehicle shoulder belt
- 28. Vehicle lap belt
- 29. Vehicle seat belt buckle  
tongue
- 30. Vehicle seat buckle
- 31. Sunshade spine
- 32. Sunshade pins

- 33. Sunshade hinge
- 34. Seat pad ring
- 35. Seat pad pin
- 36. Seat pad
- 37. Lap strap slot
- 38. Hook

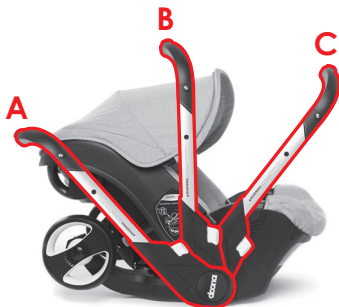
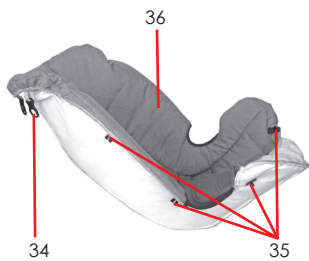

# 7 / Use Modes.



## Car Seat Mode

ALWAYS engage the handle in Position C when traveling in a vehicle. (See sections 11 or 12 for instructions on how to install the Doona Car Seat in a vehicle)

## Carrier Mode

For use of the Doona Car Seat outside of the vehicle, place the handle in position B to carry it or position A to store it out of the way when placing your child into or removing them from the carrier.

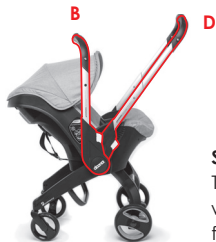

## Stroller Mode

The handle can be adjusted into Position D for walking around in open spaces or Position B for maneuvering in tight or crowded spaces.

## **⚠️ WARNING**

- Overloading the Doona Car Seat can cause it to become unstable and tip over.



- NEVER place or hang accessories which are not intended for use with the Doona Car Seat.
- Remove all bags and accessories from the Doona Car Seat before transitioning between modes.

## 7.1. Adjusting the rotation angle of the handle

You can engage the handle (#2) in three different positions: A, B, or C.

**Important!** The handle cannot be rotated when extended. To retract handle, see section 7.3 Extending and retracting handle.

- Press the handle rotation buttons (#5) on both sides simultaneously and begin rotating the handle (#2) toward the desired position, A, B, or C. Release the handle rotation buttons (#5) and rotate the handle (#2) until it is engaged in the desired position. You should hear a "click" sound when the handle is locked.

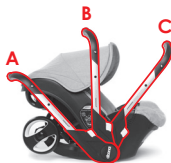

## 7.2. Extending and retracting the handle

### IMPORTANT!

The handle can only be extended or retracted when it is in position C. Handle extension or retraction is NOT possible when the handle is in positions A or B.

To extend the handle (#2) to its maximum length, press the handle extension button (#1) and pull the handle up until you hear a "click" sound and the handle is locked at its maximum length.



To shorten the handle (#2) to its minimum length, press the handle extension button (#1) and push the handle down until you hear a "click" sound and the handle is locked in its minimum length.



### 7.3. Rear wheels brakes

## ⚠ WARNING

Always engage the brakes when placing a child in Doona Car Seat or removing a child from the Doona Car Seat.

To apply the brakes on both rear wheels (#7), step on the red brake lock pedal (#15) located next to the right rear wheel.

To release the brakes from both rear wheels (#7), step on the green brake release pedal (#16) located next to the left rear wheel.



### 7.4. Changing between modes

## ⚠ WARNING

- ENSURE that the legs and handle are locked in position before attempting to transition between modes.
- The Doona Car Seat is designed to enable transition between modes while the child is securely restrained in it with the harness. Before attempting to transition between modes with the child in the Doona Car Seat, practice transitioning the empty product between stroller and carrier modes to see how the product moves during the process.
- To avoid injury, ENSURE your child is properly and securely restrained with the harness in the Doona Car Seat, or well away from the Doona Car Seat, while transitioning between modes.

## From carrier mode to stroller mode

**STEP 1.** Press the handle rotation buttons (#5) on both sides simultaneously, and rotate the handle (#2) to its upright position B.



**STEP 2.** Push in the red safety lock (#18) of the stroller wheel release (#17) at the back of the Doona Car Seat, and squeeze it up, to unfold the wheels. You should hear a “click” sound when the legs are fully opened and locked.



**STEP 3.** MAKE SURE the legs have locked into place.

**STEP 4.** Press the handle rotation buttons (#5) on both sides simultaneously, and rotate the handle into position C (toward the child's feet).



**STEP 5.** Extend the handle (#2) to its maximum length by pressing the handle extension button (#1) and pulling the handle up. You should hear a “click” sound when the handle is locked and fully extracted.



## IMPORTANT!

The handle can only be extended or retracted when it is in position C. Handle extension or retraction is NOT possible when the handle is in positions A or B.

### From stroller mode to carrier mode

**STEP 1.** Step on the red brake lock pedal (#15) located next to the right rear wheel to lock both wheels.



**STEP 2.** Press the handle extension button (#1), to retract the handle (#2) by pushing it down until it locks at its minimum length.



**STEP 3.** Press the handle rotation buttons (#5) on both sides simultaneously and rotate the handle (#2) to the upright position B.



**STEP 4.** Block the rear wheel (#7) with one foot.



**STEP 5.** Use one hand (same side as the foot blocking the rear wheel) to hold the handle (#2) and with the other hand grab the stroller wheel release (#17) at the back of the Doona Car Seat. Push in the red safety lock (#18) and squeeze the wheel release handle up.



**STEP 6.** Lean the Doona Car Seat against the rear wheel (#7), blocked by the foot, until the legs begin to fold.

**STEP 7.** Squeeze the stroller wheel release (#17) and lower the Doona Car Seat all the way to the ground, until the legs are fully folded. You should hear a click when the legs are locked.



The Doona car seat is now in carrier mode.

To install the Doona Car Seat in a vehicle, follow the instructions in this user guide, Sections 11 or 12.

## **WARNING**

The Doona Car Seat can be folded into carrier mode ONLY when all of the following actions are done simultaneously:

- Blocking the rear wheel (#7)
- Pressing the safety lock (#18)
- Squeezing the stroller wheel release (#17)
- Leaning the Doona Car Seat against the blocked rear wheel (#7)



## 8 / Securing Your Child in the Doona Car Seat.

### **WARNING**

- Read all instructions in this user guide and the instructions in your vehicle manual before using the Doona Car Seat.
- Failure to follow the information provided on the Doona Car Seat or in the user guide, could result in DEATH or SERIOUS INJURY.
- NEVER allow others to restrain a child in the Doona Car Seat unless they read the instructions in this user guide and the instructions in the vehicle manual.
- Use only with children who weigh between 4 and 35 lbs. (1.8 to 15.8 kg) and whose height is 32 inches (81 cm) or less.
- NEVER use on a vehicle seat with an active frontal airbag!
- Always properly secure your child with the harness in the Doona Car Seat.
- Snugly adjust the harness of the Doona Car Seat around your child. A snug strap should not allow any slack. It lies in a relatively straight line without sagging. It does not press on the child's flesh or push the child's body into an unnatural position.
- The shoulder straps must be routed through the shoulder strap slots which are at or just

below the child's shoulders.

- NEVER leave your child unattended.
- Stay near and watch child during use. This product is not safe for unsupervised use or unattended sleep.
- SUFFOCATION HAZARD: Infant carrier can roll over on soft surfaces and suffocate child.
  - NEVER place carrier on beds, sofas, or other soft surfaces
  - NEVER add blankets, soft bedding or padding
- FALL HAZARD: A child's activity can cause the carrier to shift. NEVER place the carrier on counter tops, tables, or any elevated surfaces.
- FALL HAZARD: The carrier can fall from the shopping cart. Do not use on shopping cart.
- Use caution around escalators, automatic doors, elevators, and moving walkways, and keep the harness adjustment strap away from moving parts.
- It is recommended to cover the Doona Car Seat when left in the car parked in the sun, as plastic and metal parts may become extremely hot.
- The Doona Car Seat does not replace a crib, a bed, a play yard or a bassinet. Should your child need to sleep, it is recommended to place the child in a suitable crib, play yard, bed, or bassinet
- Children have been STRANGLED by loose or partially buckled harness straps. Fully restrain the child even when the carrier is used outside the vehicle.



## 8.1. Infant Insert use



### **⚠ WARNING**

ALWAYS secure your child in the Doona Car Seat WITH the Infant Insert (#26) if your child weighs below 11lbs (5 kg) or if your child's shoulders, when sitting in the Doona Car Seat without the Infant Insert, are below the lowest shoulder strap slots (#20).

**STEP 1:** Place the Infant Insert (#26) at the lowest part of the seat to provide better support for your child's back.

**STEP 2:** Thread the harness buckle (#12) and its sleeve through the hole at the bottom of the Infant Insert.



**IMPORTANT!** Remove the Infant Insert (#26) when your child's shoulders, when sitting in the Doona Car Seat without the Infant Insert, are above the lowest shoulder strap slots (#20).



## 8.2. Head Support use



### **⚠ WARNING**

- NEVER place your child in the Doona Car Seat without the Head Support.
- Keep using the Head Support in the Doona Car Seat even after removing the Infant Insert.

Ensure the head support straps are wrapped around the shoulder straps (#8) and connected to the button snaps, at the back of the head support.

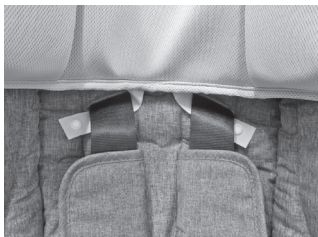

**IMPORTANT!** Ensure the shoulder straps (#8) are inserted through the shoulder strap slots (#20) at or just below the child's shoulders.



## 8.3. Harness use

### **⚠ WARNING**

- Children have been STRANGLED by loose or partially buckled harness straps. Fully restrain the child even when carrier is used outside the vehicle
- Snugly adjust the harness of the Doona Car Seat around your child. A snug strap should not allow any slack. It lies in a relatively straight line without sagging. It does not press on the child's flesh or push the child's body into an unnatural position.
- Make sure that the shoulder straps are properly secured. They should be fully inserted into the slots in the metal harness plate.
- The shoulder straps should be at or below the child's shoulders.

## Adjusting the Harness

### Loosening the shoulder straps

Press the harness adjustment button (#13) while pulling both shoulder straps (#8) toward you.



### Tightening the shoulder straps

Gently pull the harness adjustment strap (#14) until both the lap straps (#25) and the shoulder straps (#8) are snug around your child's body. Make sure that both the shoulder portion and the lap portion of the harness have been tightened.



## Adjusting the height of the shoulder straps

The shoulder straps (#8) should always be routed through the shoulder strap slots (#20). Route the straps through the slots that are at the same height or just below your child's shoulders. Periodically, check that the straps are routed through the correct slots for your child.



**STEP 1:** Place the child in the Doona Car Seat and locate the correct shoulder strap slots (#20) for your child's height. Remove your child from the Doona Car Seat.

**STEP 2:** Disconnect the shoulder straps (#8) from the metal harness plate (#21) located at the back of the Doona Car Seat and pull both shoulder straps (#8) out and through to the front of the Doona Car Seat.



**STEP 3:** Insert the shoulder straps through the correct shoulder strap slots (#20). Make sure to thread the straps at the same height on both sides and through the same slots in the seat pad and in the seat back.





**IMPORTANT!** Make sure the shoulder straps are routed between the seat body and the metal bar (#22) at the back of the Doona Car Seat. No part should go in front of the metal bar.

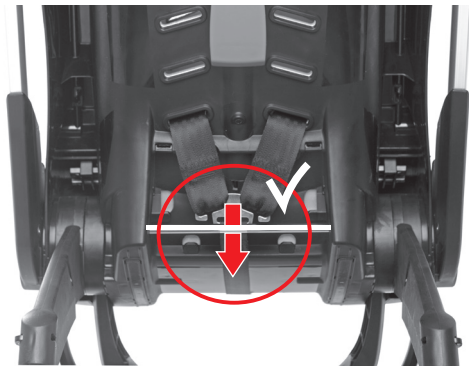

**STEP 4:** Attach the shoulder straps (#9) to the metal harness plate (#21). Make sure that the straps are fully inserted into the metal harness plate.



## **⚠ WARNING**

### **Prevent risk of ejection in a crash.**

- Make sure that the shoulder straps are not twisted and are threaded through the shoulder strap slots at the same height.
- The shoulder straps and metal harness plate **MUST** rest between the metal bar and the seat body.
- Make sure that the shoulder straps (#8) are properly secured. They should be fully inserted into the slots in the metal harness plate.

## **8.4. Buckle use**

To unbuckle the harness, press the buckle release button (#10) and pull both buckle tongues (#9) from the buckle.

To buckle the harness, insert one buckle tongue (#9) at a time into the buckle until a “click” sound is heard.

**IMPORTANT!** Both buckle tongues must be fully inserted and locked in the buckle for the harness to be buckled properly

**IMPORTANT!** Pull on the buckle to ensure it is properly locked.

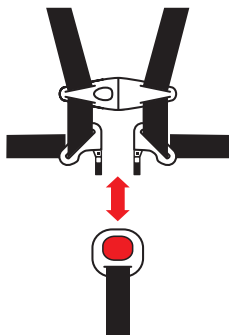

## 8.5. Chest clip use

To release the chest clip (#11), press the chest clip release button and pull apart the two parts.

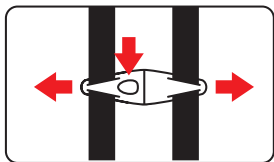

To fasten the chest clip (#11), slide the two parts together until a "click" sound is heard.

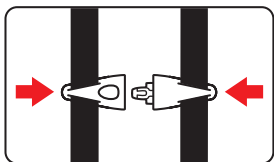

**IMPORTANT!** Adjust the chest clip to the child's arm-pit level.

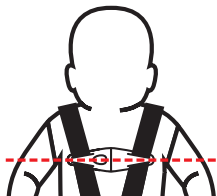

## 8.6. Shoulder strap pads adjustment

Make sure shoulder strap pads (#24) are positioned at the top of the child's shoulders.



## 8.7. Securing your child with the harness

**STEP 1:** Place your child in the Doona Car Seat with their rump against the seat back and bottom as shown.

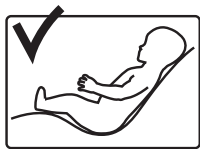

**STEP 2:** Position the shoulder strap pads (#24) above the child's shoulders. **IMPORTANT!** Check that the shoulder straps are not twisted, and make sure that the shoulder pads are positioned at the top of the child's shoulders.

**STEP 3:** Buckle the harness by inserting one buckle tongue (#9) at a time into the buckle until a “click” sound is heard.

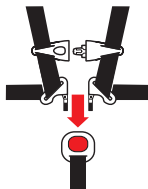

**STEP 4:** Fasten the chest clip (#11) by sliding the two halves together until a “click” sound is heard.

**IMPORTANT!** Make sure the chest clip (#11) is locked and adjusted to the child's arm-pit level.

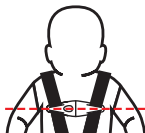

**STEP 5:** Tighten the harness straps until they are snug around your child's lap and body.

## **! WARNING**

- Snugly adjust the harness of the Doona Car Seat around your child. A snug strap should not allow any slack. It lies in a relatively straight line without sagging. It does not press on the child's flesh or push the child's body into an unnatural position.
- The shoulder straps must be routed through the shoulder strap slots that are at the same height or just below the child's shoulders.
- Doona recommends always using the shoulder strap pads provided with the Doona Car Seat. Shoulder strap pads should be located on top of your child's shoulders.

## 9 / Selecting a Vehicle Seating Position.

### **⚠ WARNING**

**Death or serious injury can occur.**

- NEVER place a rear-facing child restraint in with an active frontal air bag. An airbag hitting the Doona Car Seat can cause serious injuries to your child, possibly resulting in death.
- If your vehicle has a frontal airbag on the passenger side it **MUST BE DEACTIVATED** before installing a child restraint in that position. Check your vehicle manual for child restraint installation instructions.
- If your vehicle has seating positions with side airbags, check your vehicle manual for information about installing a child restraint in that position.
- **IMPORTANT!** Prevent damage to your Doona Car Seat and your vehicle; Check that all Doona Car Seat parts are installed as instructed to prevent them from getting caught in doors or moving seats.



- Read all instructions in this user guide and the instructions in your vehicle manual before using the Doona Car Seat.
- The Doona Car Seat can only be used in a rear-facing position when used in the vehicle.
- NEVER allow others to use or install the Doona Car Seat before they have read and understood the instructions in this user guide and the child restraint installation instructions in the vehicle manual.
- According to crash statistics, children less than 12 years old and under are safer when properly restrained in rear seating positions than in front seating positions.
- NEVER install the Doona Car Seat on a vehicle seat that is facing the rear or side of the vehicle.

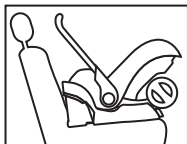

# 10 / Vehicle Seat Belts.

## 10.1 Compatible Vehicle Belts

### **WARNING**

Doona Infant Car Seat must stay securely installed. If Doona Infant Car Seat cannot be installed securely or will not stay securely installed, try installing in a different vehicle seating position or with the base and LATCH system.

Not all vehicle belts can be used with child restraints. Check your vehicle owners manual for information on installation of child restraints in the vehicle seating position chosen.

1. Combination lap-shoulder belts with free sliding latch plates.
  - The retractor on most lap-shoulder belts with free sliding latch plates can be locked. Lap-shoulder belts with lockable retractors can be used with a car seat. Pull the vehicle belt all the way out, then let it feed back in about 12 inches and pull out again. If the belt cannot be pulled back out, the retractor is locked.



- If the retractor cannot be locked, a locking clip will be needed in order to install a car seat with this vehicle belt, contact your local Simple Parenting distributor to request one.
- 2.** Combination lap-shoulder belts with locking latch plates. Locking latch plates hold a car seat secure by keeping the lap belt locked unless the latch plate is tilted.
- 3.** Inflatable lap-shoulder belts in Ford and Lincoln vehicles can be used to secure the Doona Infant Car Seat. For Installation without base, follow instructions for lap-shoulder belt standard installation in section 12.2. Most inflatable vehicle belts are labeled.
- 4.** Lap belts with locking latch plates.
- 5.** Lap belts with locking retractors. Pull the vehicle belt all the way out, then let it feed back in about 12 inches and pull out again. If the belt cannot be pulled back out, the retractor is locked. **DO NOT** use a lap belt with a retractor that does not lock.

✓	Forward facing vehicle seat	yes
⊘	Seat with active frontal airbag	no
✓	Seat with lap-shoulder belt	yes
✓	Seat with lap belt only	yes
⊘	Rear-facing vehicle seat	no
⊘	Side-facing vehicle seats	no

- ! NEVER place a rear-facing child restraint in the front seat of a vehicle with an active frontal air bag. An airbag hitting the child restraint can cause serious injuries to your child, possibly resulting in death. For vehicle seats with side airbags, please observe the instructions in your vehicle manual.

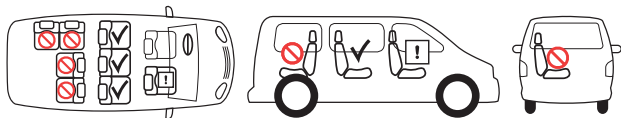

#### Inflatable Vehicle Seatbelts:

The Doona can be installed with a Ford/Lincoln inflatable seatbelt. Installation without base: Follow instructions for lap-shoulder belt standard installation.

## 10.2 Incompatible Vehicle Belt.

### **⚠ WARNING**

NEVER install the Doona Infant Car Seat in a vehicle with the following types of vehicle belts. Check your vehicle manual for information about the vehicle's seat belt type.

1. Vehicle belts that are attached to the door in any way.
2. A vehicle belt that moves along a track automatically to restrain the passenger when the door is closed.
3. Lap belts with an Emergency Locking Retractor (ELR). These lap belts stay loose and can move until locking in a crash or sudden stop.
4. Inflatable seat belts or seat belts with airbags in vehicles from manufacturers other than Ford and Lincoln. Most vehicle belts with airbags are labeled.

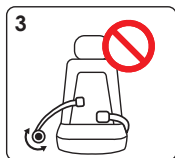

5. Lap belts forward of the seat crease or tight.
6. Combination lap-shoulder belt with two ELRs. Lap-shoulder belts that have a separate non-locking retractor each for the lap section and the shoulder section.

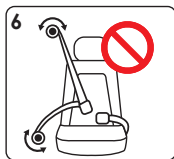
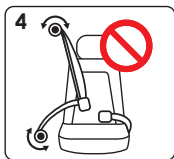

---

## 11 / Installing the Doona Car Seat with a Base.

This user guide does not include instructions for installation with a base. For detailed instructions on how to install the Doona Car Seat with the Doona Base, refer to the user guide provided with the Doona Base.

# 12/ Installing the Doona Car Seat without a Base.

## Determine installation method:

**12.1: Lap-Shoulder Belt European Installation (Preferred):** Shoulder portion of the vehicle belt is wrapped around the back of the Doona.

**12.2: Lap-Shoulder Belt Standard Installation:** Follow this method if installing with an inflatable vehicle seatbelt or if the shoulder belt is not long enough to wrap around the back of the Doona carrier.

**12.3: Lap Belt Installation:** Only in vehicle seats without shoulder belt and Aircraft.

## **WARNING**

### Ensure child's safety

- Use only in a rear-facing position when using the Doona Car Seat in a vehicle.
- NEVER leave your child unattended in the Doona Car Seat in the vehicle. Vehicle interior temperatures can rise or drop to dangerous levels very quickly. Children have died because they were left in a vehicle.
- Always fully and properly restrain the child with the harness to avoid serious injury from falling or sliding out.
- Vehicle seat belt must lock

## **WARNING**

### **Ensure correct installation**

- Make sure that the Doona Car Seat position C.
- When installed without a base, adjust the Doona Car Seat position and angle according to the red level line that appears on the side sticker. The red line should be parallel to the ground.
- In lap-shoulder belt installation DO NOT route the shoulder portion of the vehicle belt through the lap belt guides.

If you cannot achieve a secure installation, try a different vehicle seating position or installing with the Doona Base. If you have any questions about the installation, contact your local distributor.

## **WARNING**

### **General protection**

- **For the protection of all vehicle occupants** - In the case of an emergency stop, or a crash, unsecured persons or objects may cause injury to other vehicle occupants. **ALWAYS** check that the Doona Car Seat is secured when it is in the vehicle, even if no child is being transported.
- **To protect your vehicle** - Some vehicle seat covers, made from sensitive materials (e.g. velour, leather, etc.), may develop wear marks when car seats are used. This can be avoided by placing the Vehicle Seat Protector under the Doona Car Seat. The Vehicle Seat Protector is available as an accessory (sold separately).
- Parts and accessories not made by Simple Parenting for use with the Doona Car Seat may impair the performance of the Doona Car Seat in the event of a crash. **NEVER** use accessories not made by Simple Parenting for use with the Doona Car Seat or Base.
- Do not hang toys on the Doona Car Seat's handle.

## 12.1. Lap-Shoulder Belt European Installation (preferred).

### **⚠ WARNING**

- The handle must be in position C (Car Seat Mode) for correct installation in the car.
- The Doona Car Seat must be properly reclined. The seat is properly reclined when the red level line on the side sticker is parallel to the ground when installed without the Doona Base.



**STEP 1:** Place the Doona Car Seat rear-facing on the vehicle seat (child is facing backwards).



**NOTE:** Doona recommends installing the Doona Car Seat only in a rear vehicle seating position. If you must install your seat in a front vehicle seating position, check your vehicle manual to verify that it is safe to install a child restraint in this position.



**STEP 2:** Place the handle (#2) in car seat mode, position C.



**STEP 3:** Make sure that the vehicle belt is not twisted and then buckle it.



**STEP 4:** Route the lap portion of the vehicle belt (#28) through the lap belt guides (#3) located on both sides of the handle .

**IMPORTANT!** Do not route the shoulder portion of the vehicle belt (#27) through the lap belt guides (#3).



**STEP 5:** position the Doona Car Seat so the red level line on the side is level to ground (#28).

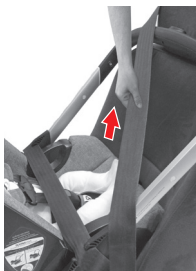

**STEP 6:** Pull the shoulder portion of the vehicle belt (#27), route it around the back of the Doona Car Seat and thread it through the vehicle shoulder belt guide (#19) located at the back of the Doona Car Seat.



**STEP 7:** Check for a secure installation: grasp the Doona Car Seat at or near the lap belt path and push side to side and front to back. The car seat should not move more than 1" in any direction.

Engage the vehicle belt locking mechanism and then feed the excess belt back into the retractor.

### **IMPORTANT!**

- Vehicle seat belt must lock, otherwise use a locking clip.
- If the shoulder belt is not long enough to go around the back of the Doona, please use the Lap Shoulder Belt Standard Installation method.
- After completing installation, check that the red level line on the side of the seat is still level to ground.
- If the Doona Car Seat cannot be securely installed in this seating position, try moving to a different vehicle seating position, or installing with the base.

## 12.2. Lap-Shoulder Belt Standard Installation.

**NOTE:** Follow this method of installation when installing with an inflatable vehicle seatbelt or if the shoulder belt is not long enough to wrap around the back of the Doona carrier.

### **! WARNING**

- The handle must be in position C for correct installation in the car.
- The Doona Car Seat must be properly reclined. The seat is properly reclined when the red level line on the side sticker is parallel to the ground when installed without the Doona Base.



**STEP 1:** Place the Doona Car Seat rear-facing on the vehicle seat (child is facing backwards).



**NOTE:** Doona recommends installing the Doona Car Seat only in a rear vehicle seating position. If you must install your seat in a front vehicle seating position, check your vehicle manual to verify that it is safe to install a child restraint in this position. The frontal airbag **MUST** be deactivated.

**STEP 2:** Place the handle (#2) in car seat mode, position C.



**STEP 3:** Make sure that the vehicle belt is not twisted and then buckle it.



**STEP 4:** Route the lap portion of the vehicle belt (#28) through the lap belt guides (#3) located on both sides of the handle .

**IMPORTANT!** Do not route the shoulder portion of the vehicle belt (#27) through the lap belt guides (#3).



**STEP 5:** Pull the shoulder portion of the vehicle belt (#27) to tighten the lap portion of the vehicle belt (#28).

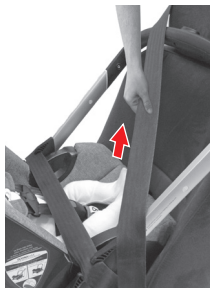

**STEP 6:** Route the shoulder portion between the Handle (#2) and the vehicle seat back (see image below).



**STEP 7:** Engage the vehicle belt locking mechanism, then feed the excess belt back into the retractor. Check for a secure installation: grasp the Doona Car Seat at or near the lap belt path and push side to side and front to back. The car seat should not move more than 1" in any direction.

### **IMPORTANT!**

- Vehicle seat belt must lock, otherwise use a locking clip.
- After completing installation, check that the red level line on the side of the seat is still level to ground.
- If the Doona Car Seat cannot be securely installed in this seating position, try moving to a different vehicle seating position, or installing with the base.

## 12.3. Lap Belt Installation.

### **⚠ WARNING**

- The handle must be in position C (Car Seat Mode), for correct installation in the car.
- Doona recommends securing your seat with a Lap Shoulder Belt European Installation whenever possible.
- The Doona Car Seat must be properly reclined. The seat is properly reclined when the red level line on the side sticker is parallel to the ground when installed without the Doona Base.



**STEP 1:** Place the Doona Car Seat rear-facing on the vehicle seat (child is facing backwards).



**STEP 2:** Place the handle (#2) in car seat mode, position C.



**STEP 3:** Make sure that the vehicle belt is not twisted and then buckle it.



**STEP 4:** Route the lap vehicle belt through the lap belt guides (#3) on both sides of the handle (#2).



**STEP 5:** position the Doona Car Seat so the red level line on the side is level to ground (#28).

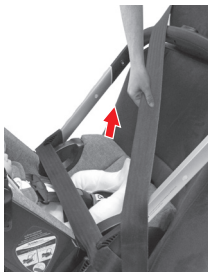

**Step 6:** Tighten the lap belt by pulling on the free end or by pressing down on Doona Car Seat and feeding excess webbing into retractor.

**STEP 7:** Engage the vehicle belt locking mechanism, then feed the excess belt back into the retractor. Check for a secure installation: grasp the Doona Car Seat at or near the lap belt path and push side to side and front to back. The car seat should not move more than 1" in any direction.

**IMPORTANT!**

- Vehicle seat belt must lock, otherwise use a locking clip.
- After completing installation, check that the red level line on the side of the seat is still level to ground.
- If the Doona Car Seat cannot be securely installed in this seating position, try moving to a different vehicle seating position, or installing with the base.

**Correct installation checklist - Doona Car Seat without base**

- Make sure that the Doona Car Seat is installed rear-facing.
- Make sure to deactivate frontal airbags if you install the Doona Car Seat on the front passenger seat.
- Make sure the Doona Car Seat is secured using a lap-shoulder belt or lap belt as instructed in this user guide.
- Make sure ONLY the lap belt section of the vehicle belt is routed through both lap belt guides located on the handle of the Doona Car Seat.
- Make sure the red level line on the side sticker on the Doona Car Seat is parallel to the ground when installed without the base.
- Make sure the vehicle seat belt is tightened.
- Vehicle seat belt must lock, otherwise use a locking clip.

**IMPORTANT!** If you cannot achieve a secure installation, try a different vehicle seating position or installing with the Doona Base. If you have any questions about the installation, please contact your local distributor.



# 13 / Care and Maintenance.

## **WARNING**

- In a crash or collision, the Doona Car Seat could suffer damage that is not necessarily visible. Doona recommends using NHTSA's re-use after crash guidelines.
- Regularly check all parts for damage. Ensure the correct operation of all mechanical components.
- Do not use the Doona Car Seat if it is damaged or broken.
- DO NOT use the Doona Car Seat without its seat pad.
- Do not use parts or accessories with the Doona Car Seat unless supplied or approved by Simple Parenting for use with the Doona Car Seat.
- Do not use the car seat or base after a crash.

## 13.1. Sunshade Removal.

**STEP 1:** Pull out the 3 sunshade snaps (#33) at the back of the sunshade (#4).

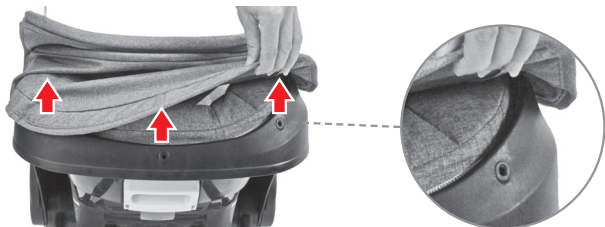

**STEP 2:** Pull out the sunshade spine (#31) from the sunshade hinges (#33).



**STEP 3:** Remove the fabric from the spine.



## 13.2. Seat Pad Removal.

**STEP 1:** Loosen the Shoulder Straps (#8) completely.



**STEP 2:** Release the Harness Buckle (#12) and the Chest clip (#11).



**STEP 3:** Disconnect the shoulder straps (#8) from the metal harness plate (#21) located at the back of the car seat.

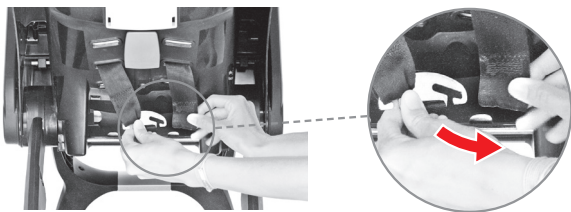

**STEP 4:** Pull out the shoulder straps (#8) from the front and remove the shoulder strap pads (#24) from them.

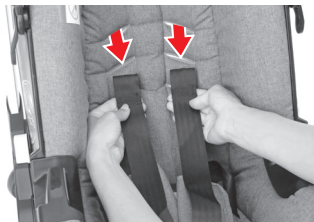

**STEP 5:** Release the seat pad from the 4 hooks (#38) behind the head area of the car seat.



**STEP 6:** Snap out the seat pad pins (#35) of both sides of the seat pad.

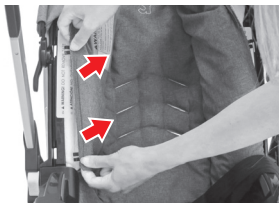

**STEP 7:** Remove the seat pad from both sides, as shown below.



**STEP 8:** Snap out the seat pad pins (#35) of the seat pad.



**STEP 9:** Pull up the seat pad from around the harness adjustment button (#13) and the harness buckle (#12) to remove the seat pad completely.



## 13.3. Seat Pad Re-fitting.

**STEP 1:** Thread the shoulder straps (#8) through the slots in the lap area of the seat pad.

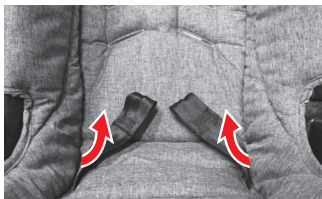

**STEP 2:** Thread the harness buckle (#12) through the designated slot in the seat pad and pull it out from the other side.

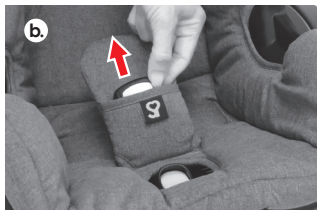

**STEP 3:** Re-fit the seat pad around the harness adjustment button (#13).



**STEP 4:** Snap in the lower seat pad pin (#35) at the bottom of the car seat.



**STEP 5:** Snap in the seat pad pins (#35) on both sides.

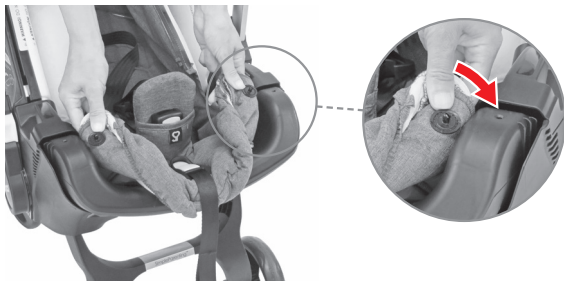

**STEP 6:** Tuck in the seat pad around the bottom part of the car seat.



**STEP 7:** Tuck in the seat pad on both sides, as shown below.





**STEP 8:** Tuck in the seat pad pins (#35) on both sides of the car seat body and push in until they snap into place.

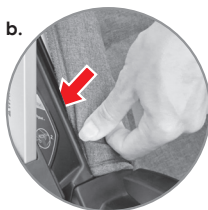
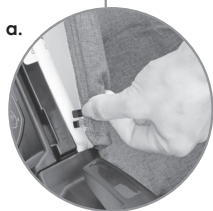

**STEP 9:** Thread the 4 seat pad rings (#34), attached to the head area of the seat pad, through the slots in the upper part of the car seat, and attach them to the hooks (#38).



**STEP 10:** Thread the shoulder straps (#8) through the appropriate shoulder strap slots (#20).

**IMPORTANT!** Shoulder straps must be routed at the same height or slightly below the child's shoulders.

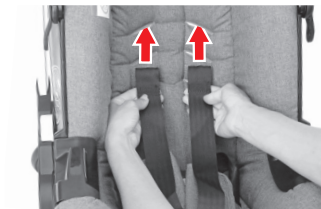

**STEP 11:** Reconnect the shoulder straps to the metal harness plate (#21) at the back of the car seat.

**IMPORTANT!** Make sure straps are not twisted.

**IMPORTANT!** The shoulder straps, attached to the metal plate, **MUST** be routed **BETWEEN** the metal bar and the seat body.

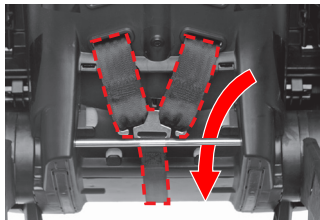

## 13.4. Sunshade Re-fitting.

**STEP 1:** Re-fit the fabric on the sunshade spine (#31).

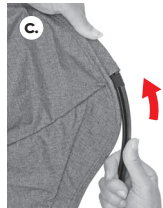
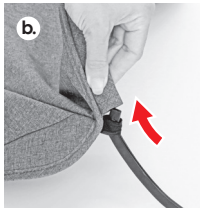
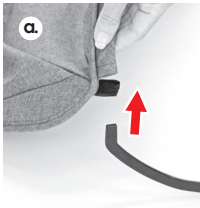

**STEP 2:** Hook in the sunshade spine (#31) into the sunshade hinges (#33).



**STEP 3:** Reconnect the 3 sunshade pins (#32) at the back of the sunshade (#4).

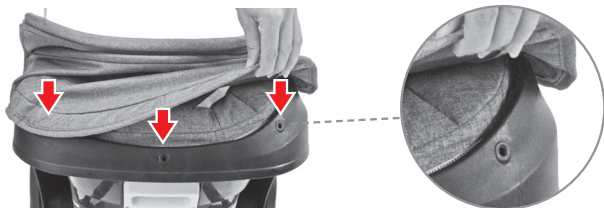

## **⚠ WARNING**

### **Correct installation**

- Make sure the harness straps are not twisted and are correctly routed through the shoulder strap slots.
- Make sure that the shoulder straps are correctly reconnected to the metal harness plate.
- Make sure that the harness metal plate (#21) and shoulder straps (#8) are routed between the metal bar (#22) and the car seat body. No part should go in front of the metal bar (#22).

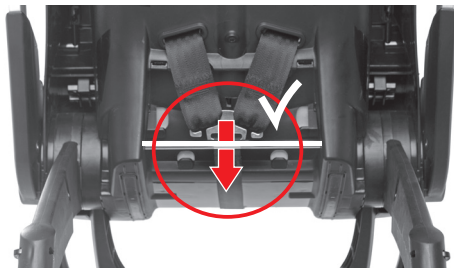

## 13.5. Cleaning the Seat Pad

### **WARNING**

- NEVER remove the buckle tongues (#9) from the straps.
- Always use only genuine seat pads, since the seat pad is an integral part of the Doona Car Seat system.
- Non-regulated products, which are not designed for use with the Doona Car Seat, can impair the safety and performance of the seat in use or in a crash.
- Always read the care labels before washing any of the Doona Car Seat parts and accessories.
- The Doona Car Seat must not be used without the seat pad.

The seat pad can be removed and washed with a mild detergent. Follow these washing instructions to avoid damage to the seat pad: Machine wash, cold; Do not bleach; Do not tumble dry; Hang dry; Do not wring; Do not iron; Do not dry clean. Follow the instructions on the washing label located on the seat pad. The same washing instructions should be followed when washing the sunshade and shoulder strap pads.

The plastic parts can be cleaned using only water with a mild detergent like dish soap. Do not use harsh cleaning agents, solvents, or lubricants when cleaning any of the Doona Car Seat parts and accessories.

## **13.6. Care for the harness straps \ harness buckle \ harness adjuster strap**

The function of the harness, harness buckle, and harness adjuster is imperative for the safety of your child.

NEVER use lubricants, solvents, soap, bleach, or other household detergents to clean the harness, harness buckle and harness adjuster.

NEVER use a washing machine or a dryer to clean the harness, harness buckle, and harness adjuster.

NEVER iron the harness webbing.

If the harness of the Doona Car Seat must be cleaned, wipe it with a damp cloth or rinse it thoroughly with clean, warm water.

NEVER disassemble the harness.

## **13.7. Cleaning the Doona Car Seat accessories**

Always read the care labels before washing any of the Doona Car Seat accessories.

## **13.8. Replacement parts**

Replacement parts are available for the Doona Car Seat.

To order replacement parts, contact your local distributor's customer service. The distributor's contact details can be found at the beginning of this user guide. Please keep the model name and serial number available to expedite service.

## **13.9. Storage**

When not in use for an extended period of time, make sure to store the Doona Car Seat in a safe and dry place out of direct sunlight. If possible, store the Doona Car Seat in a large nylon bag, or in its original package, or in the Doona Travel Bag (sold separately).

Do not place heavy objects on it.

Always keep this user guide with the Doona Car Seat.

For storing the Doona Car Seat, engage the handle in position A.

# 14 / Accessories.

Doona offers various accessories which have been tested to ensure that their use does not impair the safety or proper function of the Doona Car Seat. Instructions and warnings are provided with each accessory.

## **WARNING**

- DO NOT use the Doona Car Seat accessories before reading all warnings and instructions provided with them.
- DO NOT use accessories which were not specially designed or approved by Simple Parenting for the Doona Car Seat. The use of accessories, which are not customized for the Doona Car Seat, might cause it to fail Federal Safety Standards or not perform as intended in a crash.
- NOT all of the Doona Car Seat accessories are approved for use in a vehicle. For information about suitability, read warnings and instructions provided with each accessory or visit our website at [www.doona.com/accessories](http://www.doona.com/accessories)

# 15 / Two-year warranty.

We guarantee that the Doona Car Seat was manufactured in accordance with US safety standards and regulations, and that it meets the highest standards of quality.

For the Doona Car Seat, we provide a 2-year limited warranty against manufacturing and material defects.

The warranty period is effective from the day of purchase.

As proof of purchase, we ask that you fill out the Warranty Card and retain it for the whole term of the warranty period, together with your sales receipt.

In case of a warranty claim, the Warranty Card must be returned together with the product to your local distributor.

Please also register your Doona Car Seat online at:

[www.doona.com/register](http://www.doona.com/register)

The limited warranty will cover a Doona Car Seat which has been handled properly and which was sent to us in a clean condition.

The warranty is only valid with Simple Parenting's replacement components for this product.

Simple Parenting reserves the option to provide repair or replacement components for this product.

The limited warranty does not apply in the following cases:

- The product shows normal signs of wear and tear.
- Damage occurred as a result of exposing the product to excessive stress.
- Damage occurred as a result of inappropriate or improper use.
- The product has been used for a purpose other than that specified in this user guide.
- Damage occurred as a result of use of accessories or parts not made by Simple Parenting for use with the Doona Car Seat.

In the event of a warranty claim, please contact your local distributor:

Customer Service Tel: +1 (786) 542-6775

E-mail: [info.usa@doona.com](mailto:info.usa@doona.com)



# 16 / Warranty Card.

**Warranty card:**

Name: \_\_\_\_\_

Address: \_\_\_\_\_

Zip code: \_\_\_\_\_

City/Town: \_\_\_\_\_

State: \_\_\_\_\_

Telephone no. (including area code): \_\_\_\_\_

E-mail address: \_\_\_\_\_

Product serial number : \_\_\_\_\_

Retailer (store where purchased): \_\_\_\_\_

Receipt number: \_\_\_\_\_

**Note:** Keep the receipt together with the warranty card.