



**SECURITY SHUTTER LTD.**

# **Tape Pull & Wind** Roll Shutter Installation Guide





**Before beginning please check that shop drawing dimensions match your current project specification.**

**(See Opening Measuring Instructions for details)**

**Installation, servicing and repairs should be performed by a qualified and trained technician.**

**Please read through the entire guide thoroughly, before proceeding with installation. Security Shutter Ltd. will not be held responsible for any property damage or charges incurred due to improperly installed shutter components. The following instructions will not alleviate you from complying with local building codes and ordinances.**

## Disclosure

Ensure shutter installation does not interfere with federal, provincial or municipal building codes, safety or fire regulations or other restrictions or code that may apply. Security Shutter Ltd. will not be held responsible for any injury or death from improper installation, application or use of provided shutters.



Think ahead



Important Install Tip



Risk of product damage (handle with care)



Risk of personal injury:

- Heavy curtain
- Sharp edges
- Pinch points
- Follow safe working practices
- Heavy lifting may cause bodily harm
- Oversized shutters require 2 or more technicians for safe installation and transportation
- Do not climb or stand underneath the shutter system
- The shutter should only be operated when in view

# 8 Step Installation Process

- 1.) Prepare Opening & Tools
- 2.) Install Tips
- 3.) Mount Build-Out & Guide Rail Assembly
- 4.) U-Sill, L-Sill or No-Sill
- 5.) Route Tape Exit Port & Install Hood Assembly
- 6.) Install Tape Pull or Tape Wind
- 7.) Install Shutter Curtain
- 8.) Finalize Installation & Customer Inspection (inform end user of correct operation instructions)



# Step 1

## Prepare Opening & Tools

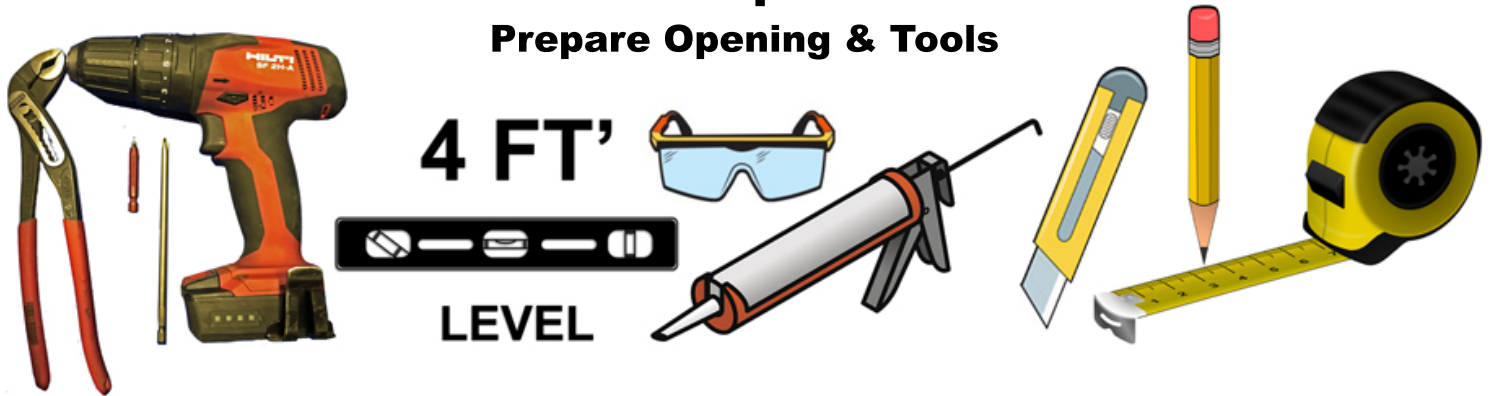

- Pliers
  - Robertson #2 Bit
  - Long Philips Bit
  - Level (Preferably 4')
  - Angle Grinder or Hack Saw
  - Pencil
  - Tape measure
  - Caulking gun and outdoor silicone sealant (Best suited for the project.)
  - Drill with masonry settings and drill bits for substrate. Concrete, wood or metal. (7/8"), (1/8"), (5/32") &/or (3/16")
  - Optional; Rivet gun + (1/8"), (5/32") &/or (3/16") SS/Aluminum rivets
  - Knife
  - Safety glasses
  - Microfiber cloth
  - Mild Detergent (ex. 409)
  - 2 or more people for assistance
  - On taller openings you may need a ladder, scaffold, etc.
  - Necessary fasteners and driver bit best suited for your project.
- EX.**
- #10 Wood Screws
  - Tapcon Concrete Anchors
  - 5 mm (3/16") Metal or Masonry Drill Bit
  - 5 mm (3/16") &/or (1/4") Driver Bit

**⚠ (2.1)** The opening structure must be adequate to accommodate the weight of the shutter system. Surfaces should be plumb and smooth to guarantee a parallel alignment of the guide rails. It is important that you check that the lintel does not bow inwards or have any protrusions that could push the hood assembly out of alignment. Check that the shutter will not interfere with any opening doors, windows, protruding door handles, etc.

**⚠ (2.2)** Unbox and inspect all shutter system components, including hardware bag before shutter installation occurs. (Do not place shutter components on rough or rugged surfaces.)



# Step 2

## Install Tips

**(2.3)** If your shutter comes with a locking end slat be sure to position the guide's lock receiver slot at the bottom of your opening. (Guide rails are NOT interchangeable from side to side.)

### Lock Receiver Slots

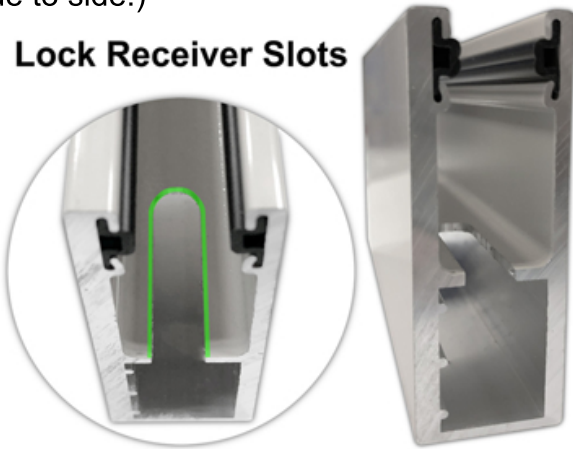

### In-Jamb Mount

**2D**

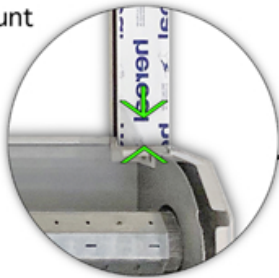

Place hood assembly top-down & seat both guide rails firmly onto both end cap legs.

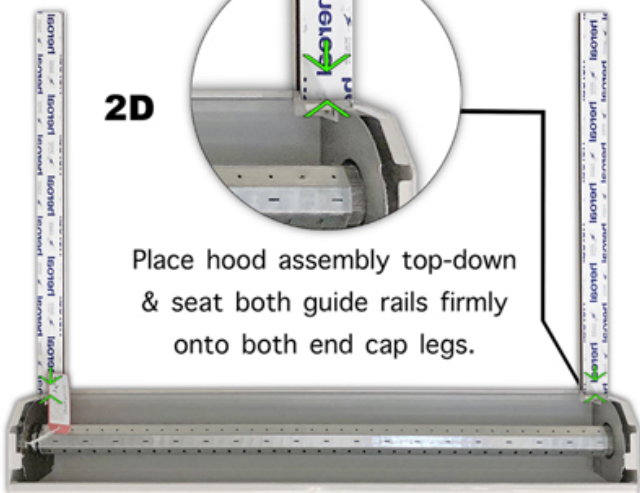

**(2.6)** For in-jamb application with no overhead clearance place hood assembly top-down & seat both guide rails firmly onto both end cap legs located at the bottom of the hood assembly. Then with assistance, gently flip & lean the now attached guide rails & hood assembly into the opening. Be sure to support the shutter so as to not kink, twist or bind hood assembly. Risk of product damage (handle with care).

**(2.4)** Remove protective foil from areas that will be inaccessible after installation process is complete.



**(2.5)** To prevent damage and for ease of access remove front 45° hood assembly cover (#2 Robertson screws).

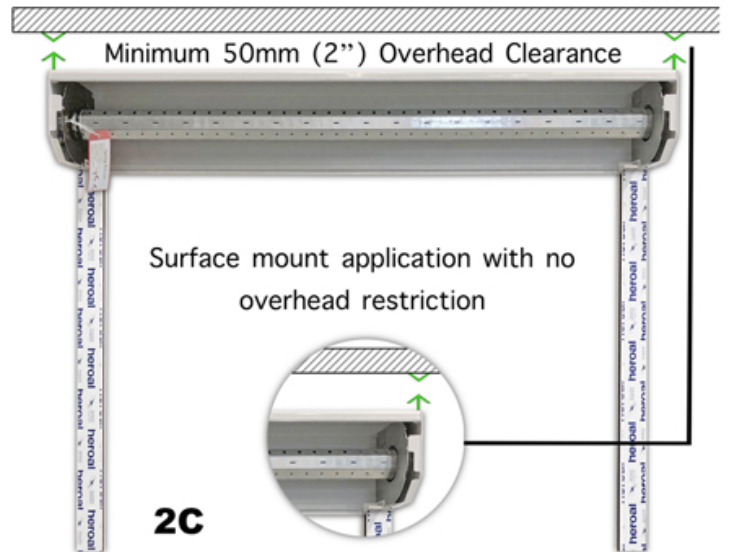

**(2.7)** For surface mount application with no overhead restriction, level and fasten the guide rails onto the opening before setting hood assembly into the guide rails. (This will require a minimum of 50mm ( 2" ) of overhead clearance above the height of the hood assembly).



# Step 3

## Mount Build-Out & Guide Rail Assembly

### (3.1) Build-Out Standard Locations:

- Left Guide Rail (pre-drilled & attached)
- Right Guide Rail (pre-drilled & attached)
- Mullion Guide
- Hood Assembly Top
- Hood Assembly Bottom
- Sill

Sizes: 10mm / 20mm / 30mm / 40mm / 50mm

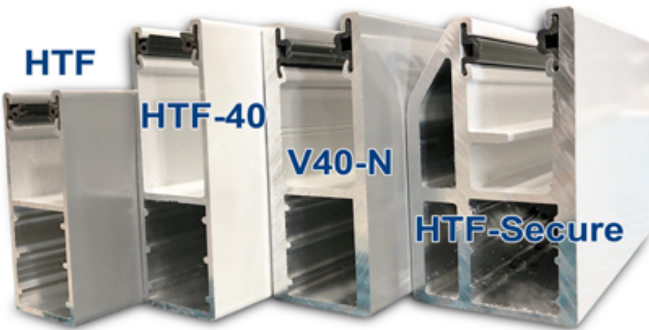

### (3.2) Proper mounting of build-out is subject to adjacent structure location and condition.

Ensure that fasteners are long enough to sufficiently penetrate mounting surface for a secure mount. Some build-out components do not come pre-attached and will require independent mounting. Reference shop drawing for further information.

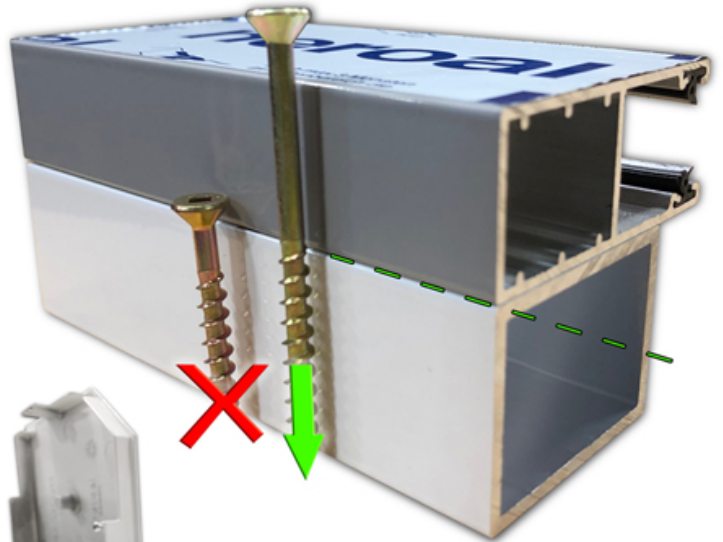

HTF & HTF-40 guide rails are interchangeable if locking end slat option is not present.



V40-N has an extra 3mm (1/8") of build-out thickness.

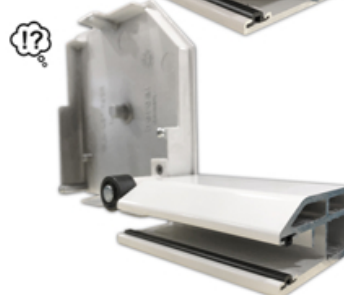

HTF-Secure has an extra 3mm (1/8") of build-out thickness and is not interchangeable. Must be mounted with protective foil side inline with the front of the hood assembly.

### (3.3) If build-out is applicable, level & fasten with unprotected side facing the wall in the following order :

- 1.) Vertical build-out with guide rails. Fasten bottom & second down mounting hole from the top (this will allow room for minor adjustment). If the floor is sloping you must install the high side first.
- 2.) Horizontal top, bottom and sill build-out.



# Step 3

## Mount Build-Out & Guide Rail Assembly

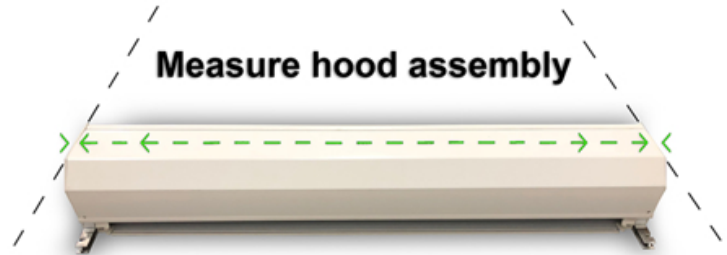
**(3.4)** Measure the hood assembly length. This will give you outside of guide rail to outside of guide rail dimension.



**(3.5)** Place marks on the opening where your guides will line up.

 **(3.6)** Level guide rails plumb & parallel with unprotected side facing the wall. If the floor is sloping you must fit the higher side first.  

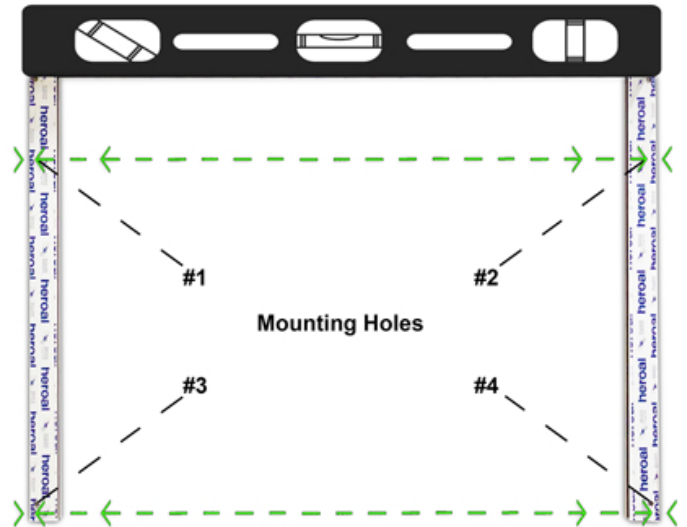



**(3.7)** Fasten guide rail's second down from the top (#1, #2) & bottom (#3, #4) mounting holes (this will allow room for minor adjustment).

# Step 4

## U-Sill, L-Sill or No-Sill

**(4.1)** Adjust bottom width of the guide rails to the length of the sill to assure optimal shutter operation.

 L-Sills are provided and mounted to the total outside width of guide rails.

 U-Sills are provided and mounted to the interior span between the guide rails. Drill adequate weeping holes for water drainage if necessary (use level to determine).

 For No-Sill applications L-Stops will be provided (installation is optional and dependant on application).

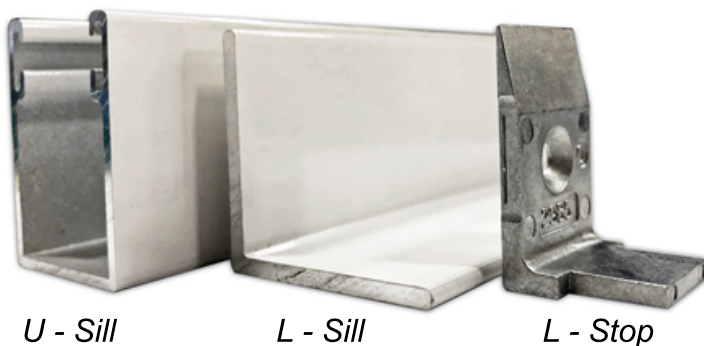

# Step 5

## Route Tape Exit Port & Install Hood Assembly

 **(5.1)** Mark and drill a 23mm (7/8") exit port passage through the wall.

 **(5.2)** Mount hood assembly by inserting end cap legs into the guide rails. (Pinch Points)

**(5.3)** Verify level, plumb & square, adjust mounting holes (#1, #2, #3 & #4) to achieve desired fit. Complete fastening guide rails ensuring that top fasteners secure hood assembly to the opening and the guide rails.

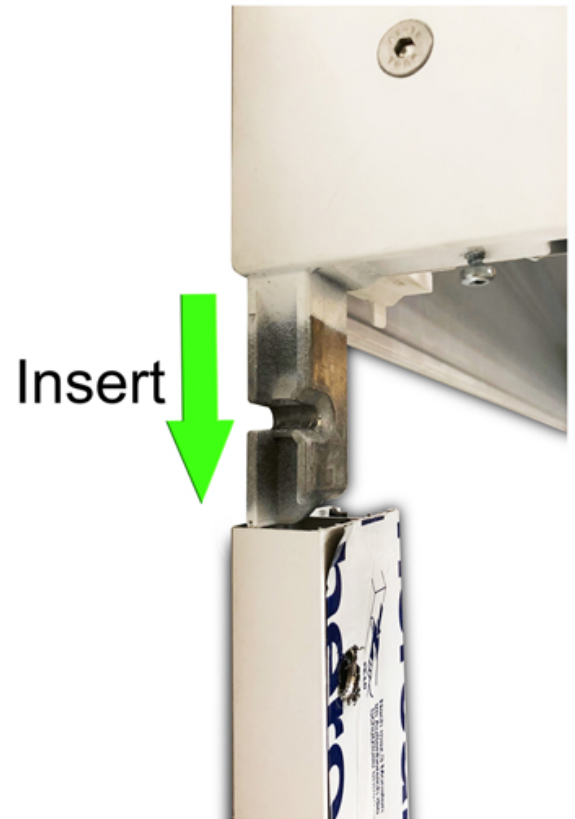
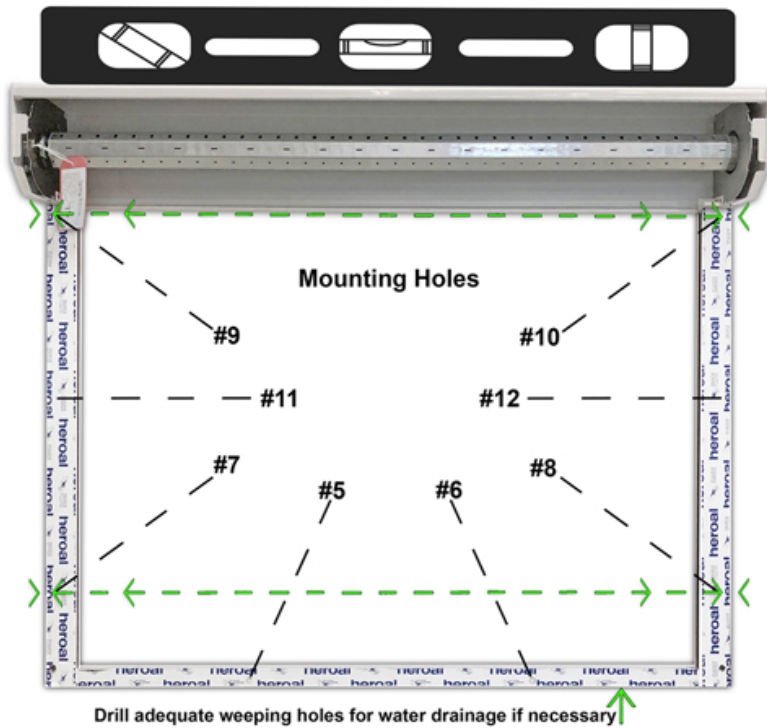

 **(5.4)** For specific commercial or oversized applications you will need to secure hood assembly to the structure behind. Use 30x30mm L-angle or flat-washers as backing to secure evenly along the edges every 30-60 cm (12"-24").



# Step 6

## Install Tape Pull or Tape Wind

**(6.1)** Insert PVC tube tape guide into the 7/8" passage through the wall. Mark and cut the length of the PVC tube to the thickness of the wall.

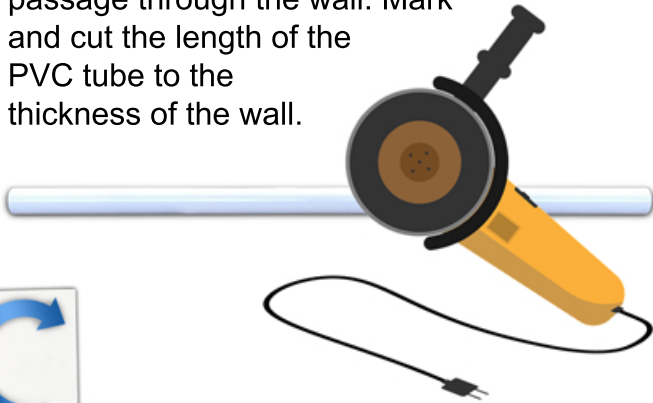

**(6.2)** Install tape roller guide on one end of the PVC tube. Insert PVC tube into the wall's 7/8" tape exit port and secure roller guide to the adjacent structure.

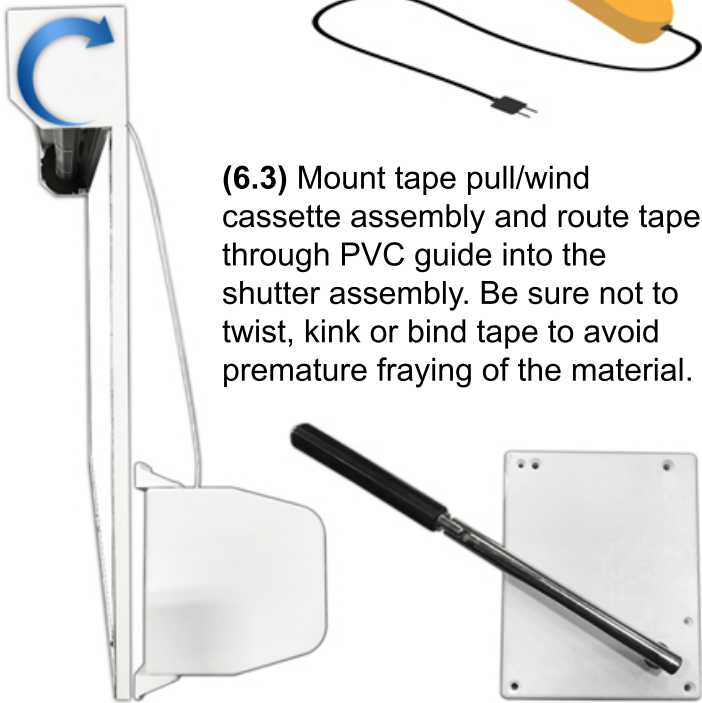

**(6.3)** Mount tape pull/wind cassette assembly and route tape through PVC guide into the shutter assembly. Be sure not to twist, kink or bind tape to avoid premature fraying of the material.

**(6.4)** You may install another tape entry guide on the opposite end of the tube inside the shutter assembly. Rivet to the inside of the hood assembly, thus reducing wind gusts and creating a smoother path for the tape operation. Be sure to position both roller guides with the roller drum on the bottom.

**(6.5)** Loop the end of the tape and attach to the allocated mounting slot in the channel located inside the tape reel.



**(6.6)** Backwind the axle tube, ensure to have enough tape revolutions on the tape reel to accommodate 30cm (12") more than the total height of the curtain.

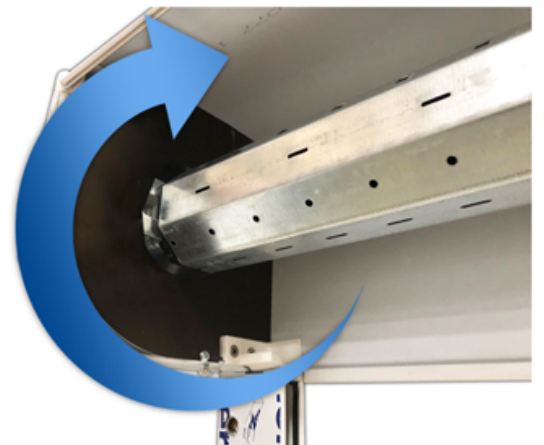







# Step 7

## Install Shutter Curtain

 (7.1) Curtain will come rolled up in barrel form. End slat with T-Stops attached on the inside & T-Hanger mounts on the outside.

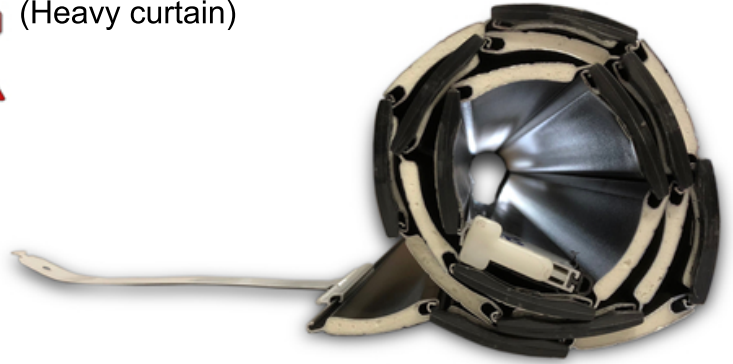
 (Heavy curtain)  





 (7.2) Post type stops must be used if locking end slat is present. Install in the second up from the bottom slat or in the top edge of the bottom end slat.



 (7.3) Non-adjustable End slat T-Stops do not fit through curtain entry guides. Curtain entry guides must be temporarily removed to enable end slat entry into the top of the guide rails. Remove curtain entry guides using a long Philips bit.



 (7.4) If adjustable T-Stops are present in the end slat they should be set to an approximate angle of 45° to enable end slat entry into the top of the guide rails. Once end slat enters the guide rails, T-stops should be set horizontally to prevent the curtain from being retracted back out of the guide rails. (Pinch Points)



(7.5) Separate all T-Hangers evenly. (1 hanger for every 30cm – 50cm span (12”-20”)).



# Step 7

## Install Shutter Curtain

 (7.6) With assistance, attach and unroll the curtain outside of the guide rail manually. (Heavy Curtain, Pinch Points)



 (7.7) Using the tape pull/wind mechanism, retract curtain into the hood assembly. Guide slowly to avoid damage. (Pinch Points)



 (7.8) Guide curtain down into the guide rails to its lowest position. (Pinch Points)



 (7.9) Install curtain entry guides with a long Philips bit and adjust tape length if necessary. Ensure that you have a minimum of 1 tape revolution around the tape reel at all times.

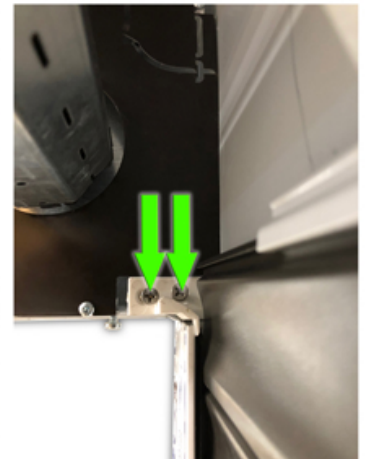

# Step 8

## Finalize Installation & Customer Inspection

 (8.1) Install post type stops if necessary.

(8.2) Check for proper lock operation.

(8.3) Inspect all components of the hood assembly:

- Ensure bearings are fully seated.
- T-hangers are spaced evenly (1 hanger for every 30cm – 50cm span (12"-20")).
- Axle has less than 3mm (1/8") play side to side.
- 60/70mm Axle bolt set screw is tight.
- No debris inside the guide rails.
- Ensure that shutter operates without binding or rubbing. (Roll curtain up and down a few times, this procedure will centre the curtain within the guide rails and hood assembly).
- Check all fasteners holding the unit to the building structure.

 (8.4) Re-install front hood assembly cover. If the shutter hood assembly is fitted externally, cover should be fastened using (1/8"), (5/32") or (3/16") rivets.

 (8.5) Ensure that all opening gaps are sealed with silicone to avoid water penetration. For exterior applications, a rain drip cap is recommended.  
(Not provided.)

(8.6) With customer present remove protective foil and install plug buttons or round attachment profile (RAP).

(8.7) Clean shutter assembly using a microfiber cloth & mild detergent (409).



# Step 8

## Finalize Installation & Customer Inspection

 **(8.8)** After installation, shutter end-user should be trained how to properly operate the shutter system in a safe manner to avoid damage or injury. The shutter should only be operated when in view. User should ensure there are no objects or persons in the opening before and during operation.



shutter system in a safe manner to avoid damage or injury. The shutter should only be operated when in view. User should ensure there are no objects or persons in the opening before and during operation.

You are all done. Please don't hesitate to contact us with any questions or concerns. A properly installed shutter will operate trouble-free for many years to come. Should a replacement part be required, refer to the limited lifetime warranty for more information.



 Failure to follow these installation instructions could result in damage or injury. Security Shutter Ltd. installation guide is tailored to an experienced installer and assumes basic understanding of construction rules, regulations and mounting techniques. Do not climb or stand underneath the shutter system at any time.



construction rules, regulations and mounting techniques. Do not climb or stand underneath the shutter system at any time.

### **WINTER CONDITIONS**

During freezing conditions, ensure the curtain and guide rails are clear of any ice or snow buildup before operation. Operating shutter with frozen debris attached to the curtain or guide rails may cause damage to the roll shutter system. Additionally use caution, do not roll up a wet shutter curtain when freezing conditions may be imminent as dropping temperatures could freeze the water on the coiled curtain with ice inside the box housing. If the shutter is not operating smoothly during freezing conditions, never force the shutter up or down.

### **Maintenance Instructions**

With the shutter in the completely open position, use a damp microfiber cloth to wipe down the inside of the guide rails. Spray the inside of the guide rails with **DRY GRAPHITE** or **DRY SILICONE SPRAY ONLY**. **DO NOT** use any oil-based lubricants such as **WD-40**. Dampen cloth with the silicone spray and wipe down the outside of the hood assembly, the exterior of the guide rails and universal joint if applicable. This procedure should be performed once a year.

### **Warranty for this product shall only be granted if:**

- The installation is carried out by a certified and competent installer following these instructions.
- Only original OEM parts are used.
- No additional foreign objects are attached to the shutter system.
- Regular maintenance checks are performed.