



SECURITY SHUTTER LTD.

Motorized

Roll Shutter Installation Guide





SECURITY SHUTTER LTD.

Before beginning please check that shop drawing dimensions match your current project specification.

(See Opening Measuring Instructions for details)

Installation, servicing and repairs should be performed by a qualified and trained technician.

Please read through the entire guide thoroughly, before proceeding with installation. Security Shutter Ltd. will not be held responsible for any property damage or charges incurred due to improperly installed shutter components. The following instructions will not alleviate you from complying with local building codes and ordinances.

Disclosure

Ensure shutter installation does not interfere with federal, provincial or municipal building codes, safety or fire regulations or other restrictions or code that may apply. Security Shutter Ltd. will not be held responsible for any injury or death from improper installation, application or use of provided shutters.



Think ahead



Important Install Tip



Risk of product damage (handle with care)



Risk of personal injury:

- Motorized operation
- Electrocuting / Fire hazard
- Heavy curtain
- Sharp edges
- Pinch points
- Follow safe working practices
- Heavy lifting may cause bodily harm
- Oversized shutters require 2 or more technicians for safe installation and transportation
- Do not climb or stand underneath the shutter system
- The shutter should only be operated when in view

8 Step Installation Process

- 1.) Prepare Opening & Tools
- 2.) Install Tips
- 3.) Mount Build-Out & Guide Rail Assembly
- 4.) U-Sill, L-Sill or No-Sill
- 5.) Install Hood Assembly
- 6.) Motor Wiring Diagrams (RTS, Standard, CMO)
- 7.) Set Limits & Install Shutter Curtain
- 8.) Finalize Installation & Customer Inspection (inform end user of correct operation instructions)

Step 1

Prepare Opening & Tools

4 FT'



LEVEL

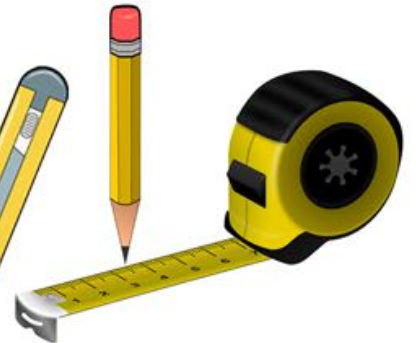

- Pliers
 - Wire strippers and crimper
 - Electrical tape
 - Electrical twist-on wire caps
 - Robertson #2 Bit
 - Long Philips Bit
 - Level (Preferably 4')
 - Pencil
 - Tape measure
 - Caulking gun and outdoor silicone sealant (Best suited for the project.)
 - Drill with masonry settings
 - Optional; Rivet gun + (1/8"), (5/32") &/or (3/16") SS/Aluminum rivets.
 - Drill bits for substrate. Concrete, wood or metal. (1/8"), (5/32") &/or (3/16")
 - UL Certified junction box
 - Conduit
 - Knife
 - Safety glasses
 - Microfiber cloth
 - Mild Detergent (ex. 409)
 - 2 or more people for assistance
- On taller openings you may need a ladder, scaffold, etc.
- Necessary fasteners and driver bit best suited for your project.

EX.

- #10 Wood Screws
- Tapcon Concrete Anchors
- 5 mm (3/16") Metal or Masonry Drill Bit
- 5 mm (3/16") &/or (1/4") Driver Bit

⚠ (2.1) The opening structure must be adequate to accommodate the weight of the shutter system. Surfaces should be plumb and smooth to guarantee a parallel alignment of the guide rails. It is important that you check that the lintel does not bow inwards or have any protrusions that could push the hood assembly out of alignment. Check that the shutter will not interfere with any opening doors, windows, protruding door handles, etc.

⚠ (2.2) Unbox and inspect all shutter system components, including hardware bag before shutter installation occurs. (Do not place shutter components on rough or rugged surfaces.)

⚠ (2.3) Mark and drill wire lead hole before installing any shutter components.
DO NOT CUT MOTOR WIRE LEAD WITHIN 30cm (12") OF THE TUBULAR MOTOR
This will damage the antenna which is incorporated into the lead.

Step 2

Install Tips

 **(2.4)** To prevent damage and for ease of access remove front 45° hood assembly cover (#2 Robertson screws).



 **(2.5)** Remove protective foil from areas that will be inaccessible after installation process is complete.



 **(2.6)** For in-jamb application with no overhead clearance place hood assembly top-down & seat both guide rails firmly onto both end cap legs located at the bottom of the hood assembly. Then with assistance, gently flip & lean the now attached guide rails & hood assembly into the opening. Be sure to support the shutter so as to not kink, twist or bind hood assembly. Risk of product damage (handle with care).

 **(2.7)** For surface mount application with no overhead restriction, level and fasten the guide rails onto the opening before setting hood assembly into the guide rails. (This will require a minimum of 50mm (2") of overhead clearance above the height of the hood assembly).

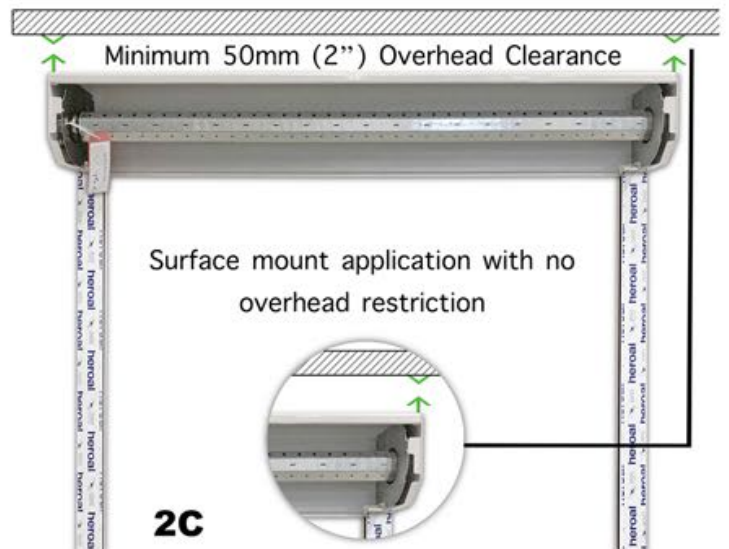
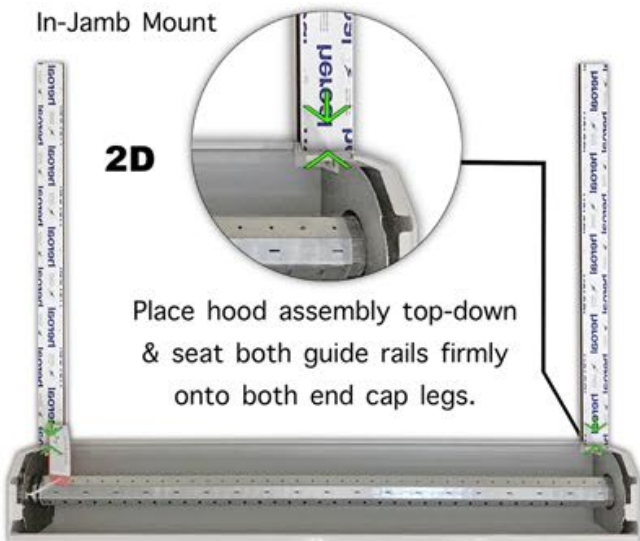

Step 3

Mount Build-Out & Guide Rail Assembly

(3.1) Build-Out Standard Locations:

- Left Guide Rail (pre-drilled & attached)
- Right Guide Rail (pre-drilled & attached)
- Mullion Guide
- Hood Assembly Top
- Hood Assembly Bottom
- Sill

Sizes: 10mm / 20mm / 30mm / 40mm / 50mm

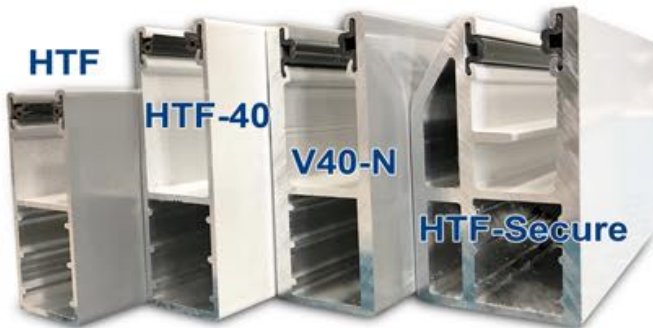

(3.2) Proper mounting of build-out is subject to adjacent structure location and condition.

Ensure that fasteners are long enough to sufficiently penetrate mounting surface for a secure mount. Some build-out components do not come pre-attached and will require independent mounting. Reference shop drawing for further information.

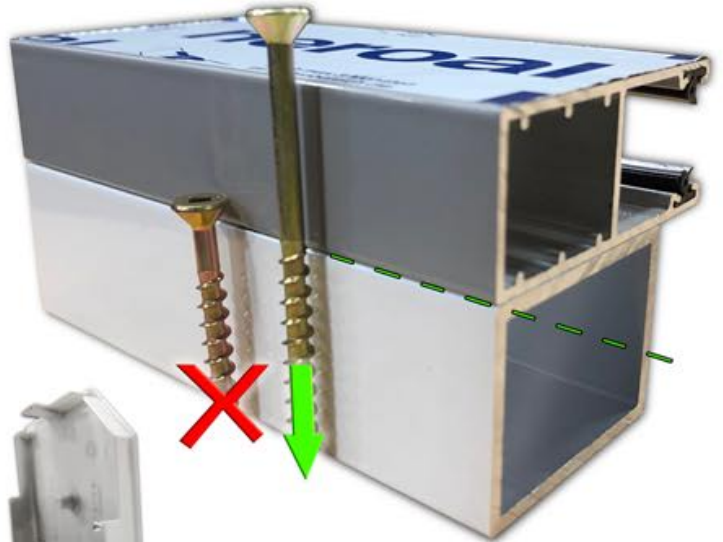

HTF & HTF-40 guide rails are interchangeable.



V40-N has an extra 3mm (1/8") of build-out thickness.



HTF-Secure has an extra 3mm (1/8") of build-out thickness and is not interchangeable. Must be mounted with protective foil side inline with the front of the hood assembly.

(3.3) If build-out is applicable, level & fasten with unprotected side facing the wall in the following order:

- 1.) Vertical build-out with guide rails. Fasten bottom & second down mounting hole from the top (this will allow room for minor adjustment). If the floor is sloping you must install the high side first.
- 2.) Horizontal top, bottom and sill build-out.



Step 3

Mount Build-Out & Guide Rail Assembly

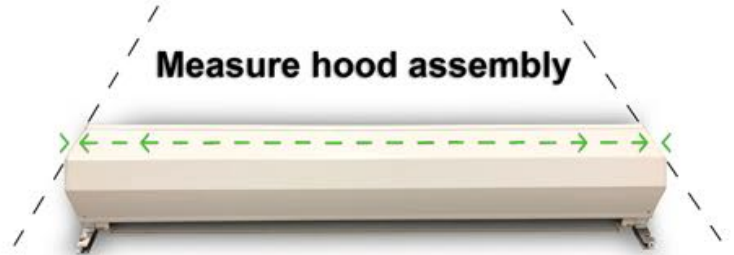
(3.4) Measure the hood assembly length. This will give you outside of guide rail to outside of guide rail dimension.



(3.5) Place marks on the opening where your guides will line up.

 (3.6) Level guide rails plumb & parallel with unprotected side facing the wall. If the floor is sloping you must fit the higher side first. 

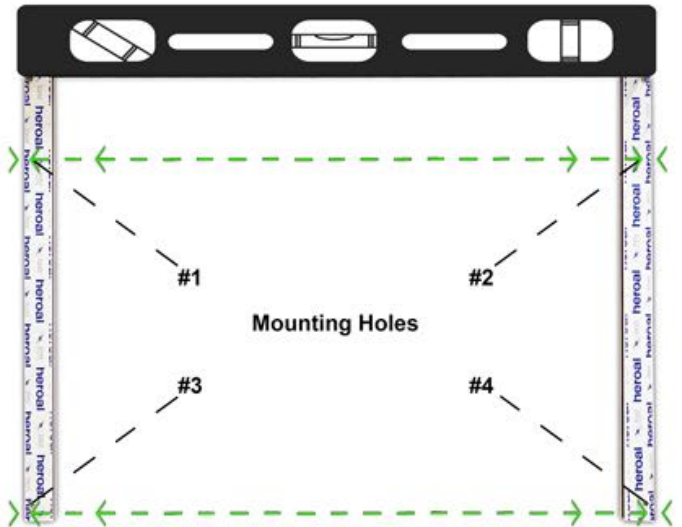



(3.7) Fasten guide rail's second down from the top (#1, #2) & bottom (#3, #4) mounting holes (this will allow room for minor adjustment).

Step 4

U-Sill, L-Sill or No-Sill

(4.1) Adjust bottom width of the guide rails to the length of the sill to assure optimal shutter operation.

 L-Sills are provided and mounted to the total outside width of guide rails.



 U-Sills are provided and mounted to the interior span between the guide rails. Drill adequate weeping holes for water drainage if necessary (use level to determine).

 For No-Sill applications L-Stops will be provided (installation is optional and dependant on application).



Step 5

Install Hood Assembly

-  (5.1) 60mm/70mm axles have an adjustable shaft on the opposite side of the motor.
-  Check set screw before attaching the hood assembly.



-  (5.3) With assistance feed wire lead through previously drilled exit hole in the opening and mount hood assembly by inserting end cap legs into the guide rails. (Pinch Points)

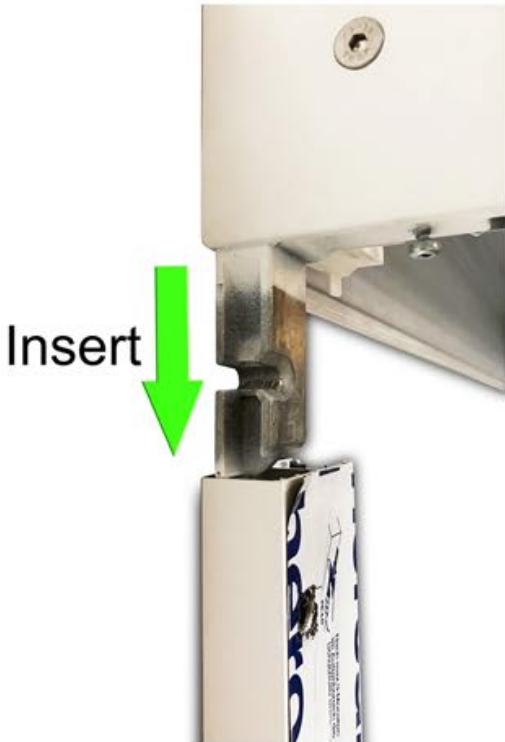

- (5.2) Feed the wire lead through the hood assemblies's exit port grommet.



- (5.4) Verify level, plumb & square, adjust mounting holes (#1, #2, #3 & #4) to achieve desired fit. Complete fastening guide rails ensuring that top fasteners secure hood assembly to the opening and the guide rails.

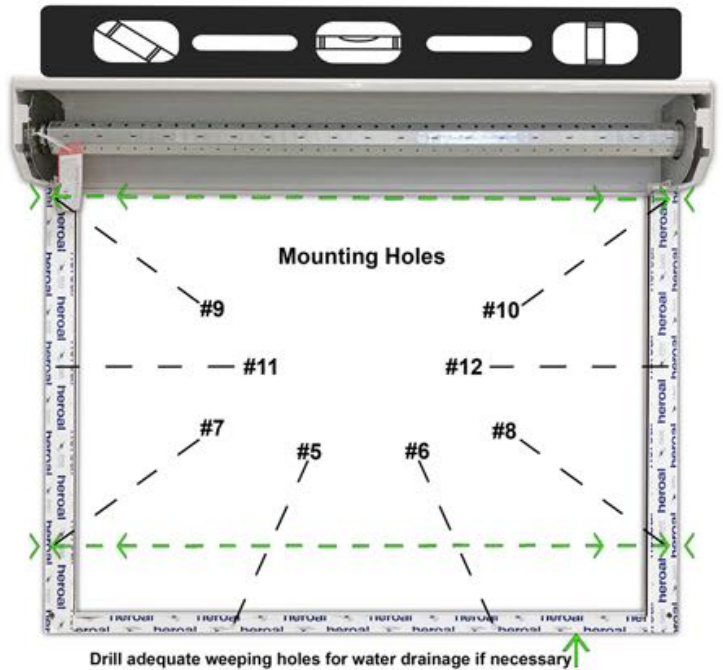

-  (5.5) For specific commercial or oversized applications you will need to secure hood assembly to the structure behind. Use 30x30mm L-angle or flat-washers as backing to secure evenly along the edges every 30-60 cm.



Step 6

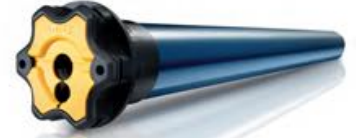

Motor Diagrams (RTS, RTS CMO)

⚠ DO NOT CUT MOTOR WIRE LEAD WITHIN 30cm OF THE TUBULAR MOTOR (12")
This will damage the antenna which is incorporated into the wire lead.

❌ (6.1) Make the appropriate wire connections for the tubular motor.

? RTS tubular motors are fast and easy to install. 3 wire Lead (Hot, Neutral, Ground)
RTS motor lead with a 120V wall plug can be supplied at extra cost, (plug in any 120V wall socket, no electrician required).

Limits are set with any Somfy RTS Remote / Keypad / Smoove.

? CMO tubular motors come in both RTS (3 wire) & Standard (4 wire). Crank Manual Override does not interfere with the motors limit settings allowing both manual and electrical operations to function separately. Main purpose of a CMO type motor is to allow end-user to operate the shutter in case of power outage.

LT50 ALTUS RTS AND LT50 RTS CMO MOTOR WIRING COLOR CODE

120V AC	CODE
BLACK	(H) HOT
WHITE	(N) NEUTRAL
GREEN	(G) GROUND

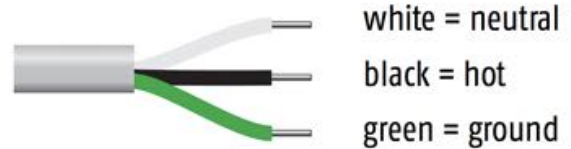

Battery backup available from tubular motor manufacturer only. Refer to Somfy specifications.
<https://www.somfysystems.com>

LT50/60 ALTUS RTS

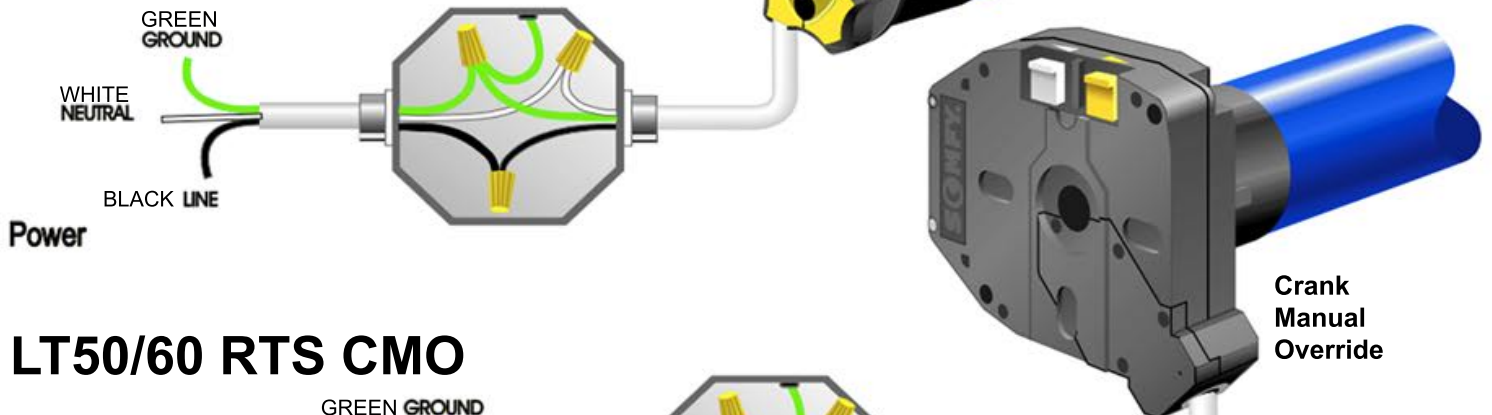

LT50/60 RTS CMO

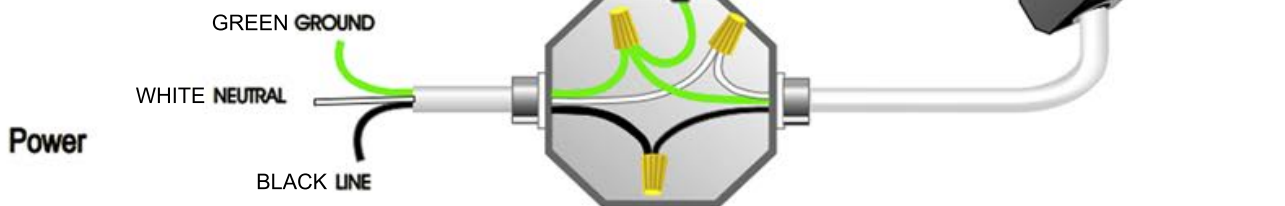

Step 6

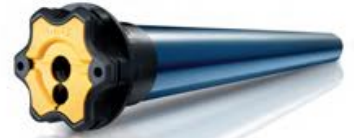

WARNING (STANDARD, STANDARD CMO)

- ⚠ Standard and standard CMO tubular motors require a licensed electrician for completing the installation procedure.
- ⚠ For outdoor installations a drip loop must be formed on the wire lead to prevent water from entering the tubular motor.

⚠ Incorrect

Do not wire two or more standard LT motors to one single pole switch. This will cause the motors to malfunction and void warranty.

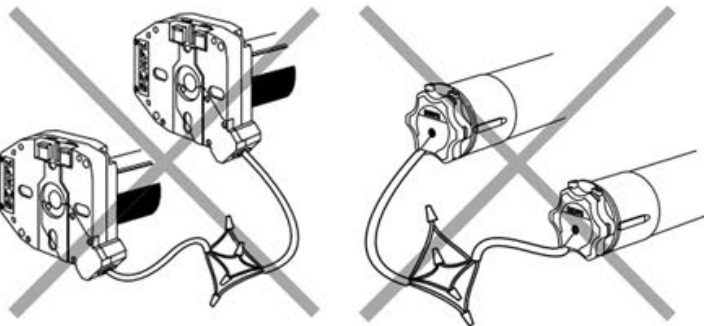

💡 Correct

Two motors, double pole switch.

- All lead connection must be carried through a UL certified junction box. Use twist-on wire caps to secure wire lead connections.
- To control more than 2 motors with 1 switch you will need to install an Individual Group Control (IGC4N1).
- Photo eye sensors may be installed for safety. Smart Motor Control (SMC II Required).

💡 Correct

One motor, single pole switch.

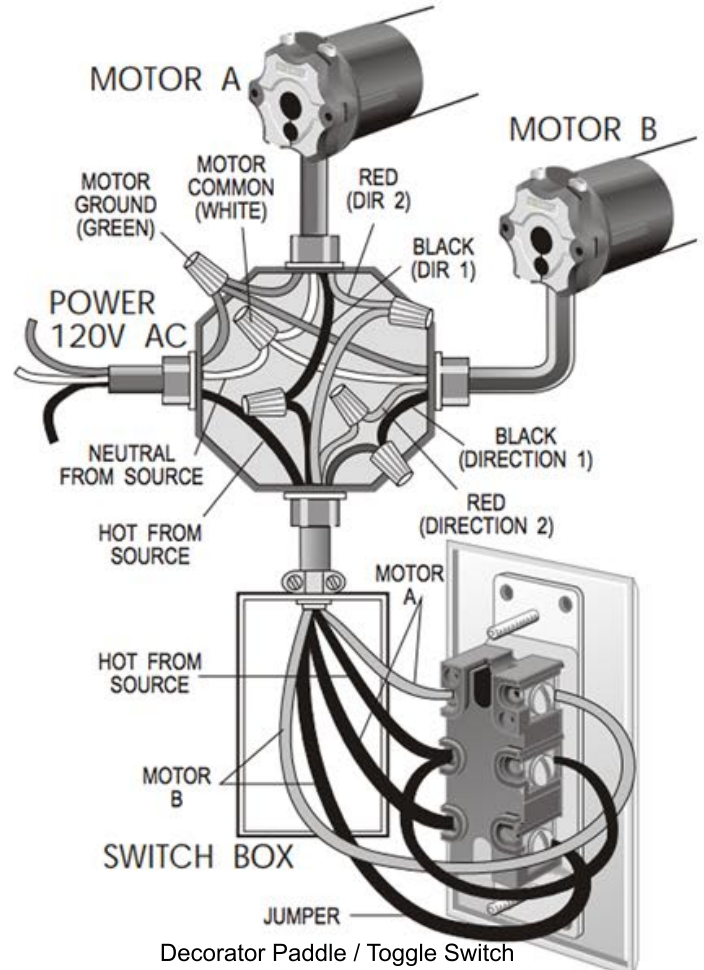
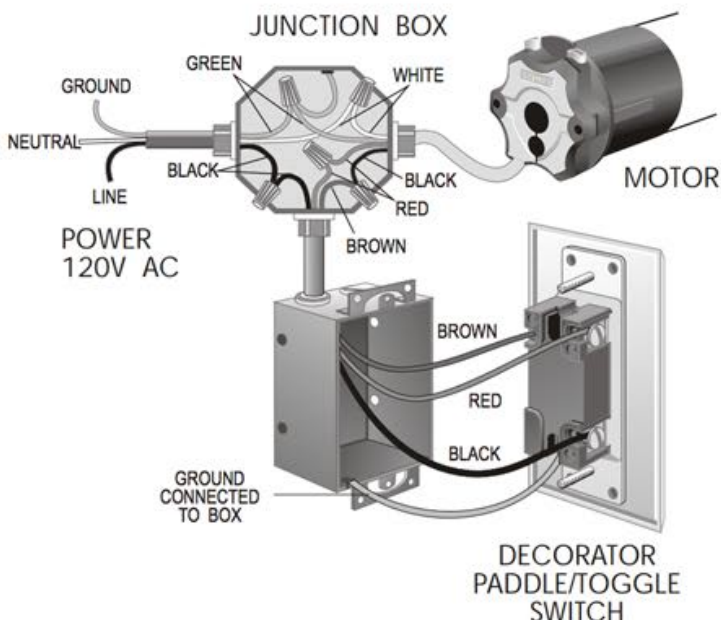

Step 6

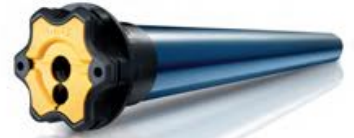

Motor Diagrams (STANDARD, STANDARD CMO)

⚠ Standard and standard CMO tubular motors require a licensed electrician for completing the installation procedure.

⊗ (6.2) Make the appropriate wire connections for the tubular motor.

? **STANDARD** tubular motors are to be hardwired inline with your house's breaker box and light switch circuits.

Limits are programmed by depressing push-button limits by the end cap motor mounts. Push in yellow and white button to set.

? **CMO** tubular motors come in both RTS (3 wire) & Standard (4 wire). Crank Manual Override does not interfere with the motors limit settings allowing both manual and electrical operations to function separately. Main purpose of a CMO type motor is to allow end-user to operate the shutter in case of power outage.

LT MOTOR WIRING COLOR CODE

120V AC	CODE
BLACK	WHITE PUSH-BUTTON
RED	YELLOW PUSH-BUTTON
WHITE	(C) COMMON
GREEN	(G) GROUND



white = neutral
red = direction 1
black = direction 2
green = ground

LT50/60

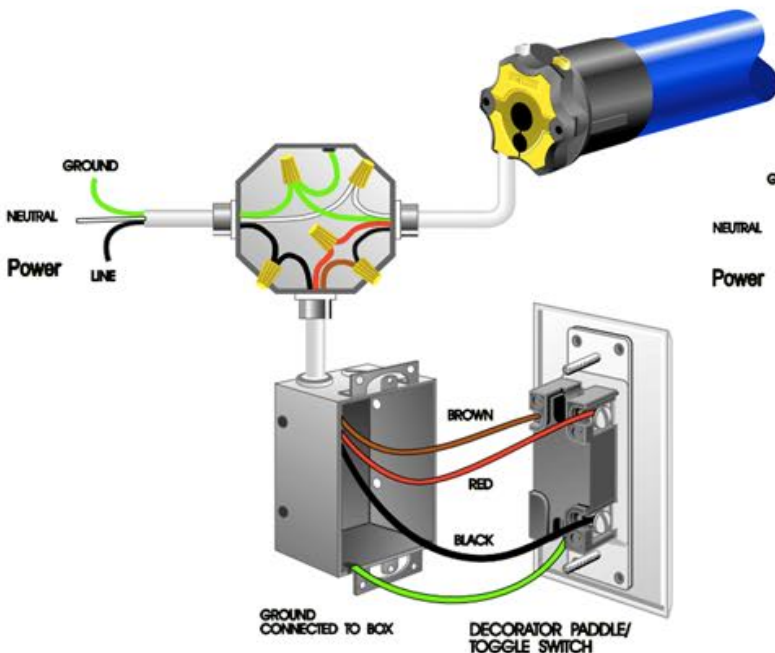

LT50/60 CMO

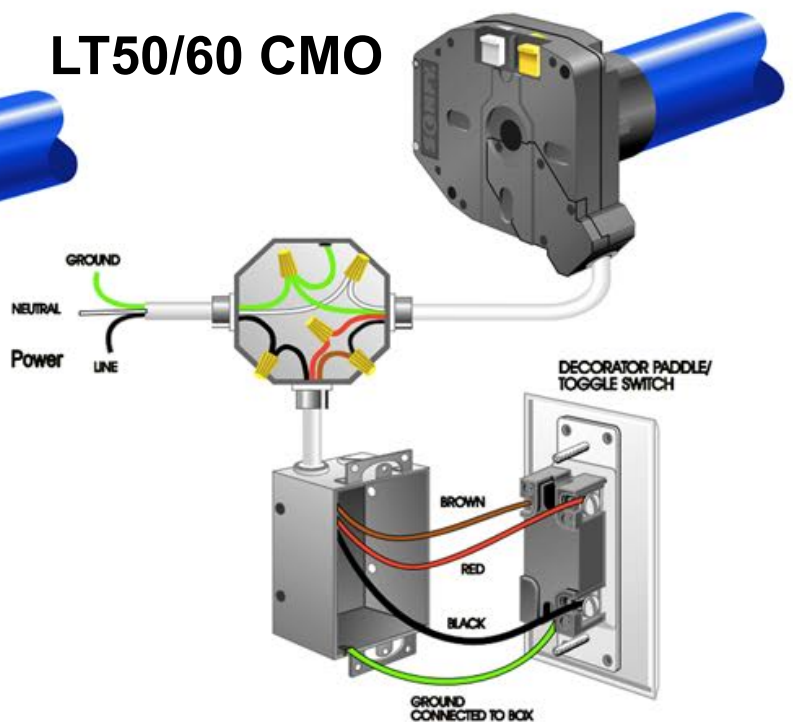

Step 7

Set Limits & Install Shutter Curtain (RTS)



(7.1) Initiate programming by pressing both the UP and DOWN buttons at the same time until the axle / motor jogs.





(7.3) Position the axle tube so that the mounting slots for anti-push-up curtain mounts are easily accessible.

(7.2) Check the direction of operation. Press and hold the DOWN button and confirm it moves the motor down (motor will be in momentary mode). To change the direction, press and hold the MY button until the motor jogs.



(7.5) Using a remote, roll the curtain up and over into the guide rails to your desired upper limit. Press and hold the MY and DOWN buttons until the motor moves DOWN, then release. Stop the motor where the LOWER limit should be set, you can adjust by pressing the direction buttons.

 (7.4) Attach & separate all anti-push-up mounts evenly. (1 mount for every 30cm – 50cm span (12”-20”)). With assistance attach and unroll the curtain outside of the guide rail manually.





(7.6) Press and hold the MY and UP buttons until the motor starts to move up, then release. The motor will stop at the original upper point.

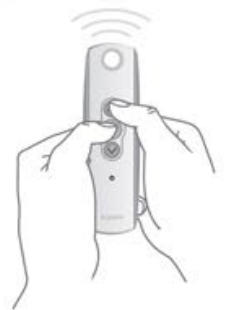

(7.7) Press and hold the MY button until the curtain jogs to confirm the limit setting.

(7.8) Press and hold the Program button on the back of the transmitter until the motor jogs. It will now operate in a maintained fashion.



***Jog** - Brief back and forth or up and down movement from the motor.

Change limit: Move the motor to its current limit position to be changed and let it stop. Press the UP and DOWN buttons simultaneously until the motor jogs, then release. Adjust to a new limit position. Press the MY button until the motor jogs, then release. Check the new limit.

Reset a previously programmed motor: You will need to disconnect power (120V AC) for 3 seconds, reconnect for 8 seconds, disconnect for another 3 seconds and reconnect. The motor should start to move/jog and then stop on its own, (if this does not happen, continue to perform the disconnects until it does). Once the motor stops, press and hold the programming button on the back of the remote and count to ten without letting go. While holding the reset button, the motor should jog twice.

Step 7

Set Limits & Install Shutter Curtain (RTS CMO)



(7.9) Make sure both limit setting buttons are fully depressed into the RTS CMO motor.



(7.10) Initiate programming. Refer to page 11, section 7.1 - 7.4 for further instructions.



(7.11) SET UPPER LIMIT Press and hold the UP button of the remote to roll the curtain up and over into the guide rails to your desired upper limit position, then release. Press and release the upper limit button on the motor so it is in the upper position.



(7.12) SET LOWER LIMIT Press and hold the DOWN button of the remote to move the motor to the desired lower limit position, then release. Press and release the lower limit button on the motor so it is in the upper position.



(7.13) To complete the programming sequence refer to page 11, section 7.7 - 7.8 for further instructions.

Add a remote/channel or sun or wind sensor: First select the remote/channel that is already programmed to the motor and press the program button on the back until the motor jogs. Then select the remote/channel/sun or wind sensor that you would like to add and press the program button on that until the motor jogs.

Set Limits & Install Shutter Curtain (Standard / Standard CMO)

UP Limit

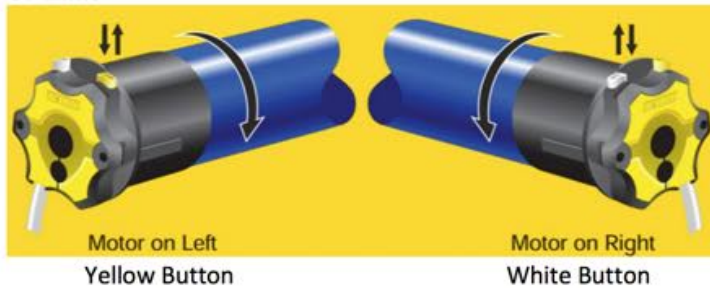

DOWN Limit

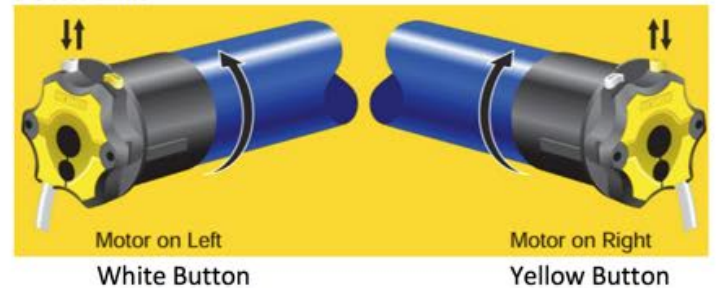

(7.14) Make sure both limit setting buttons are fully depressed into the Standard / CMO motor.

(7.15) Using the installed toggle/paddle switch position the axle tube so that the mounting slots for anti-push-up curtain mounts are easily accessible.

(7.16) Refer to page 11, section 7.4 for curtain mounting instructions.

(7.18) Roll the curtain down to your desired bottom limit. Fully depress corresponding button out so it is in the upper position. Limits are set.

(7.17) Roll the curtain up and over into the guide rails to your desired upper limit. Fully depress corresponding button out so it is in the upper position.

Step 8

Finalize Installation & Customer Inspection

(8.1) Check for proper motor & limit operation.



(8.2) Inspect all components of the hood assembly:

- Ensure bearings are fully seated.
- Anti-Push-Up mounts are spaced evenly (1 hanger for every 30cm – 50cm span (12"-20")).
- Axle has less than 3mm (1/8") play side to side.
- 60/70mm Axle bolt set screw is tight.
- No debris inside the guide rails.
- Ensure that shutter operates without binding or rubbing. (Roll curtain up and down a few times, this procedure will centre the curtain within the guide rails and hood assembly).
- Check all fasteners holding the unit to the building structure.

(8.3) Re-install front hood assembly cover. If the shutter's hood assembly is fitted externally, cover should be fastened using (1/8"), (5/32") or (3/16") rivets.



(8.4) Ensure that all opening gaps are sealed with silicone to avoid water penetration. For exterior applications, a rain drip cap is recommended. (Not provided.)



(8.5) With customer present remove protective foil and install plug buttons or round attachment profile (RAP).



(8.6) Clean shutter assembly using a microfiber cloth & mild detergent (409).



Step 8

Finalize Installation & Customer Inspection

-  (8.7) After installation, shutter end-user should be trained how to properly operate the shutter system in a safe manner to avoid damage or injury. The shutter should only be operated when in view. User should ensure there are no objects or persons in the opening before and during operation.
- 

You are all done. Please don't hesitate to contact us with any questions or concerns. A properly installed shutter will operate trouble-free for many years to come. Should a replacement part be required, refer to the limited lifetime warranty for more information.



-  Failure to follow these installation instructions could result in damage or injury. This installation guide is tailored to an experienced installer and assumes basic understanding of construction rules, regulations and mounting techniques. Do not climb or stand underneath the shutter system at any time.
- 

WINTER CONDITIONS

During freezing conditions, ensure the curtain and guide rails are clear of any ice or snow buildup before operation. Operating shutter with frozen debris attached to the curtain or guide rails may cause damage to the roll shutter system. Additionally use caution, do not roll up a wet shutter curtain when freezing conditions may be imminent as dropping temperatures could freeze the water on the coiled curtain with ice inside the box housing. If the shutter is not operating smoothly during freezing conditions, never force the shutter up or down.

Maintenance Instructions

With the shutter in the completely open position, use a damp microfiber cloth to wipe down the inside of the guide rails. Spray the inside of the guide rails with **DRY GRAPHITE** or **DRY SILICONE SPRAY ONLY**. **DO NOT** use any oil-based lubricants such as **WD-40**. Dampen cloth with the silicone spray and wipe down the outside of the hood assembly, the exterior of the guide rails and universal joint if applicable. This procedure should be performed once a year.

Warranty for this product shall only be granted if:

- The installation is carried out by a certified and competent installer following these instructions.
- Only original OEM parts are used.
- No additional foreign objects are attached to the shutter system.
- Regular maintenance checks are performed.