

DVR-4CH-H265-BP
DVR-8CH-H265-BP
DVR-16CH-H265-BP

BLUPONT XVR Quick Start Guide

Please read the Quick Start Guide carefully before using the product and keep it.
Related tools and documents of products, please download from www.herospeed.net.

1.Statement

- This manual is for BLUPONT XVR C/CB/ D/DB/PG/PGH /L housings.
- This manual may contain some contents that are technically inaccurate or inconsistent with product functions and operations or wrongly printed. The contents of this manual will be updated according to the enhancement of products without prior notice. If the description of product in the

manual does not match with the actual object, please prevail in kind.

2.Safety Instructions

- This equipment should be installed in well-ventilated environment. When installing, please keep proper space with the ground. It is good for machine heat dissipation that keeping proper space with the ground when install. Keep the equipment away from heat source and high temperature environment.
- The device should be installed horizontally, to avoid the installation in a strong vibration position.
- This device is not waterproof. To avoid fire or other hazards caused by short-circuit, shall prevent the device from getting wet.
- Please use the hard disk recommended by the manufacturer (generally recommend monitor level hard disk of Seagate and Western Digital) to meet the requirements of long time reading and writing of big data. Please buy from form channels to ensure the quality of hard disk.
- This product can not withstand heavy loads. Do not place heavy objects or multi-layer overlays on this product.
- BLUPONT XVR installation and construction must meet the specifications, may refer to the relevant national or local standards.

3.Hard disk installation

NOTE:

- 1) Please use the BLUPONT XVR dedicated SATA hard disk recommended by the device manufacturer. Make sure the power is off before installation.
- 2) The following pictures and installation diagrams for reference only, subject to the available products.

3.1 Hard disk installation guide for BLUPONT XVR PG / PGH series

- 1) Unscrew the screws and remove upper cover.



- 2) Align the hard disk screw holes to the chassis backplane, and then tighten lock the screws.



- 3) Connect one end of the hard disk power cable and data cable to the motherboard and the other end to the hard disk.

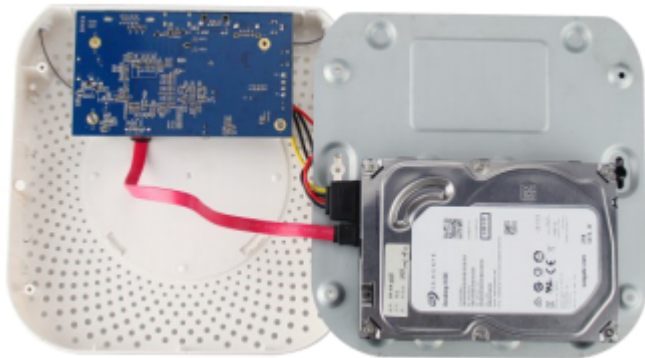

- 4) Install the cover and fix it by screws.

3.2 Hard disk installation guide for BLUPONT XVR CB / C / DB / D series

- 1) Unscrew the screws on the back and sides of the chassis and remove the cover.



- 2) Connect one end of the hard disk power cable and data cable to the motherboard and the other end to the hard disk.



- 3) Align the hard disk screw holes to the chassis backplane, and then tighten lock the screws.



4) Install the cover and fix it by screws.



3.3 Hard disk installation guide for BLUPONT XVR L series

1) Unscrew the back panel screws and take off the cover.



2) Remove the hard disk rack.

3) Install the hard disk to the rack from top to bottom.

4) Fix the hard disk by screws.

5) Install the rack and fix it.

6) Connect the hard disk power cable and data cable.

7) Install the cover and fix it by screws.



4.Rear panel interface description

4.1 BLUPONT XVR rear panel interface description

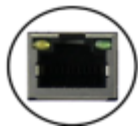

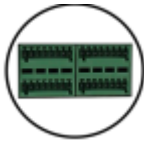

4.2 8 Channels D series BLUPONT XVR rear panel interface description

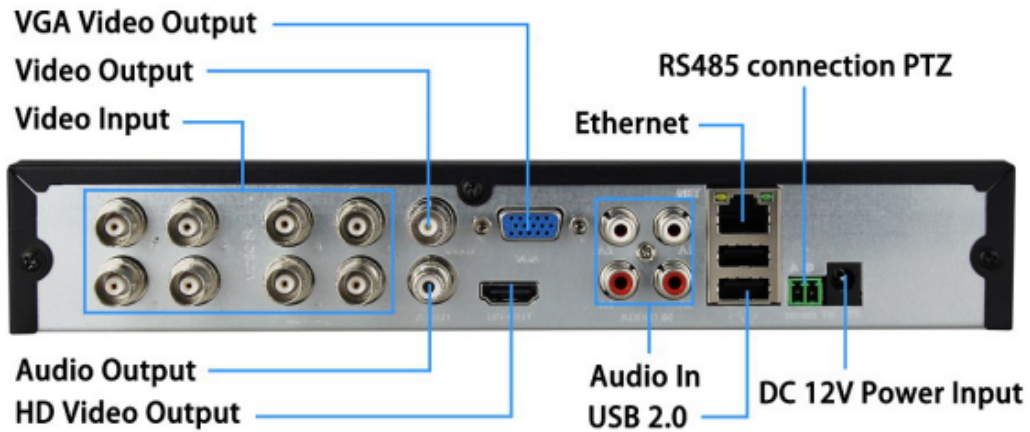

4.3 32 Channels L series BLUPONT XVR rear panel interface description

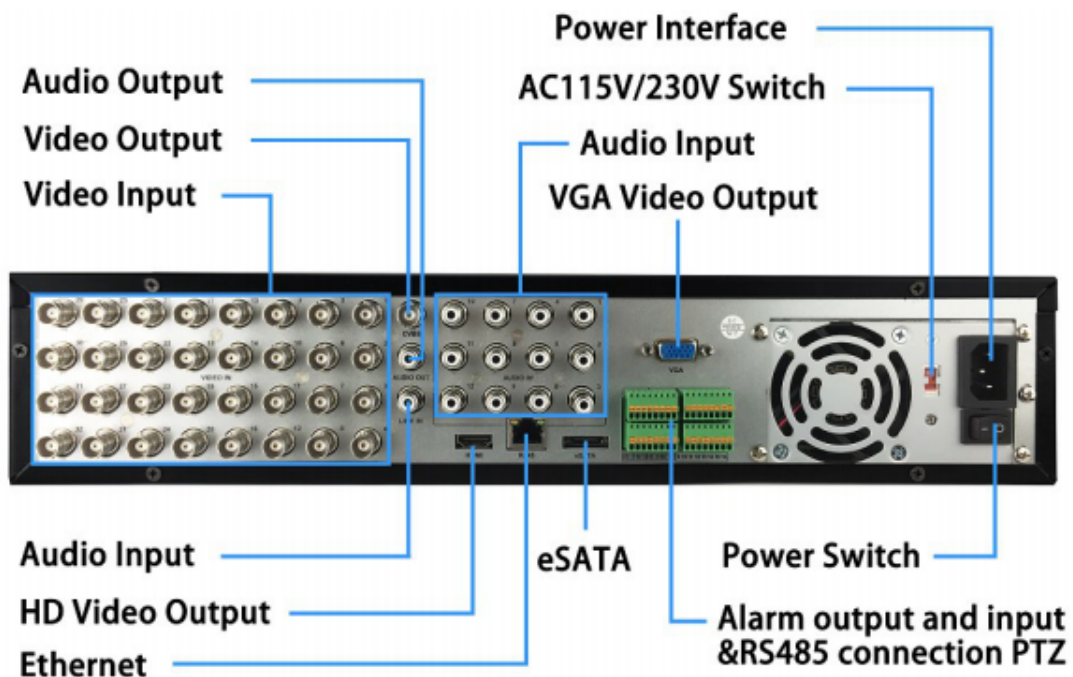

NOTE:

BLUPONT XVR rear panel interface is similar with above picture, but the product appearance, including interfaces and layout, for reference only, please prevail in kind.

5. Local Basic Operation

5.1 Boot up

NOTE:

1. It is recommended that you refer to international standards for power supply input with stable voltage values and low ripple interference.
2. Some devices do not have power button and will boot up directly when plug into an

electric power supply.

Make sure the input voltage matches the BLUPONT XVR consumption. Connect the device to the monitor and to the power adapter (if available). Plug in the power, switch on the power button (if available), then the device boot up.



5.2 Boot Wizard

You can perform basic configuration on the device through the Power-on Wizard.

Step 1: The device automatically enters the Boot Wizard page after it is powered on. Click "Next", enter the administrator password, select the language, click "Login", "Modify", modify the login password, and click "Save" to enter the boot wizard "General" page.

Step 2: After configuring the basic settings such as language, record mode, video standard, and device time, click "Next" to set related parameters for other interfaces.



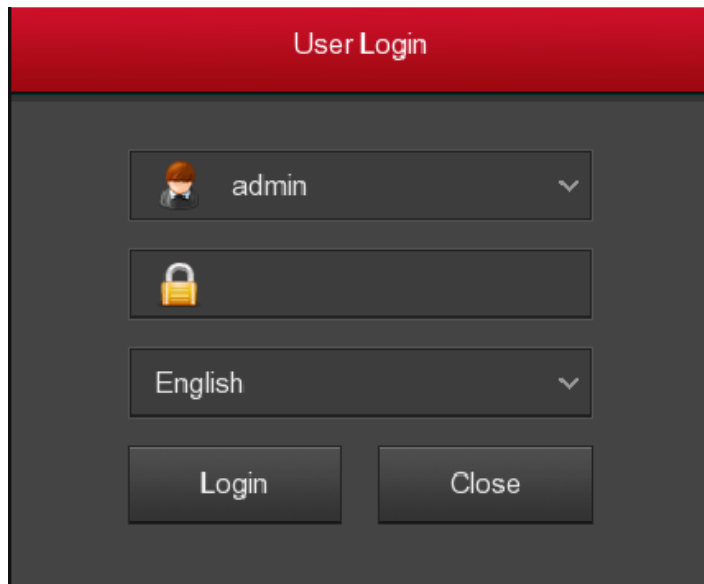

NOTE:

1. If you do not need to set the device, you can click "Cancel" to exit the boot wizard interface. You can also turn off the boot wizard in " Menu > Configuration> General ".
2. You should reset the device administrator password (the system default username is "admin" and the password is "12345") when booting for the first time. To ensure the security of the device, please save the admin login password and modify it regularly.

5.3 Network Settings

Network parameters must be properly configured before operating the device over the network.

Procedure: Choose "Menu > Configuration > Network". The system displays the IP/Port interface. Modify the IP address of the device according to the actual network plan. (The default IP address of the BLUPONT XVR is 192.168.1.88.).

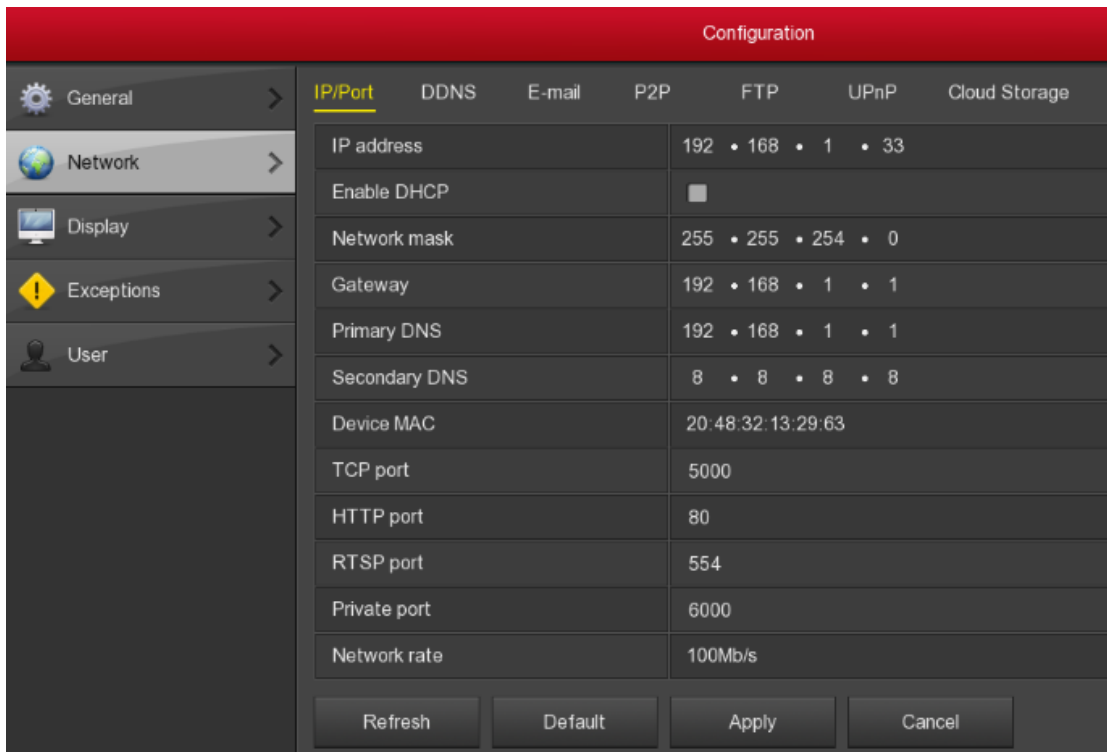

5.4 Channel Configuration

Step 1: Choose “Menu> Configuration> Channel Config”.

Step 2: Select the signal access type of each channel as required.

Step 3: Click “Apply>Confirm”, the device restarts and the modified Channel configuration takes effect.



NOTE:

1. Single channel select signal access mode to follow certain rules, the interface will be

automatically reflected in the optional options.

2. The actual access signal should be checked with the signal mode. If a channel selected "HD" mode, you can access the TVI/CVBS/AHD/CVI signal; when switching signals cause abnormal display, you can reconnect the video cable; if a channel is selected "IP" mode, is the IP channel , Can access IP equipment.

3. In the preview interface, when the HD (TVI/CVBS/AHD/CVI) channel has no image source, the channel displays "HD VIDEO"; when there is no signal source in the IP channel, the channel displays "NO CONFIG". When there is no image source, the channel displays "NO VIDEO".

5.5 Add IP device

Before accessing and configuring the IP channel, make sure that the BLUPONT XVR network connection is correct and valid.

Step 1: Choose "Menu> Camera> Add Camera" to enter the Add Camera interface.

Step 2: Add IPC by automatically or manually.

Automatically add, click "Auto add" button.

Manually add a device, click "Add", the Device Search interface automatically searches for "Onvif" or "Private" protocol (if our company IPC recommends selecting "Private"), select the IP device to be added, and click "Add".

5.6 Recording Settings

NOTE:

The device opens all channels by default for 24 hours record.

Step 1: Choose "Menu> Record > Schedule" to enter the Schedule interface.

Step 2: Select the channel and recording type according to the actual needs. Hold down

the left mouse button and drag the mouse in the time period diagram or click " " to set the recording schedule.

5.7 Instant playback

Step 1: When the mouse clicks anywhere in the current channel screen, the control bar will automatically pop up below the channel.

Step2: Click " " to enter the instant playback interface, can play the first 5 minutes of the current channel video.

5.8 Playback

Step 1: Choose "Menu > Playback" or right click on the preview interface and select "Playback" to enter the Playback interface.

Step 2: Choose "Date > Channel > More". Double click to search for the file, and the

interface will start playing the file. Or select the "time > channel", left mouse click on the time progress bar below the playback interface to play the video.

5.9 Shut down

Choose "Menu> Shut Down", click "Shut Down".

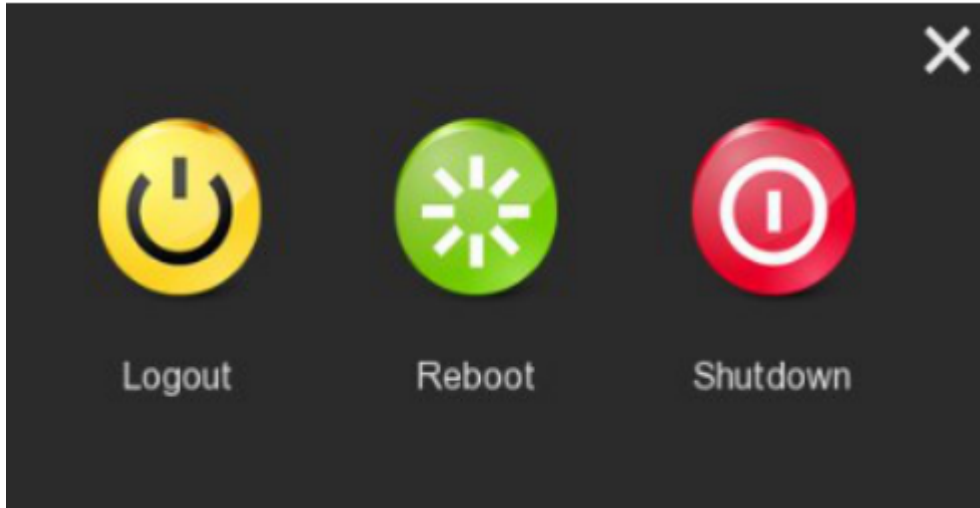

6.WEB Operation

6.1 Login

BLUPONT XVR LAN login(the PC and the device are in the same router)

Step 1: Make sure the BLUPONT XVR and PC are in same network segment. If not, the network segment of PC need to be set up to the same segment with BLUPONT XVR, such as "192.168.1.99".

Step 2: Open IE browser, select Tools > Internet Options > Security > Custom Level > ActiveX controls and plug-ins, all options are enabled.

Step 3: Open "Search Tool", double-click the target device from the search result to enter the login interface, or open the IE browser to enter the BLUPONT XVR address: such as "http://192.168.1.88/" (If the http port of the BLUPONT XVR is changed to 89, enter "http:// 192.168.1.88:89/") to enter the login interface.

Step 4: Enter the device user name (default is "admin"), password (default is "12345"), and click "Login".



6.2 Preview

In the preview interface, click the play button at the bottom. For the first time connecting, you have to download and install the plugin before previewing.

NOTE:

The Web-side can also perform the operations such as system, network, storage, playback, download, upgrade, maintenance, and factory reset on the Web.

7. Mobile App Operation

Step 1: Download and Install

Use the Android or iOS phone to scan the corresponding QR code or search "BitVision" from the application store to download and install the BitVision App.



Android download QR



iOS download QR

Step 2: Account login



Run BitVision App, click " " in the sliding sidebar, enter the account name and password, and click "Login" (Note: no account is required to register first).

Step 3: Add device



After login, click "Device manage" , " " and " Add device" , select "SN Add", enter the device user name, password and verification code after scan the QR code (the verification code printed on the label), click "Add" to set device note and group, click "Send" after add successfully.

Step 4: Live preview



Select "Real time" and " " to enter the device list in the main interface, select the touching pen and the channel to be previewed in the group, you will see the live video after click "Done ".

8.Disclaimer

The following exemptions or limitations of liability, please pay special attention to:

1. As a result of the following reasons, if the product interrupts or terminates the service for any of the following reasons, the company shall not be liable for personal injury or property damage to you or a third party. Failure to install or use properly as required; for the sake of national or public interest; force majeure; your own or third-party reasons (including but not limited to the use of third-party products, software or components, etc.
2. The company has not expressed or implied that this product is applicable to special purpose. This product may not be used in medical / safety equipment or other applications where there is a breakdown of the product that could result in life-threatening or personal injury, as well as hazardous or non-humanitarian hazards such as weapons of mass destruction, biological and chemical weapons, nuclear explosions or any unsafe use of nuclear energy use. Any loss or liability arising out of the above use will be at your own risk.
3. This product, when properly installed and used, can detect unauthorized intrusion during a particular delight but can not avoid accidents or personal injury or property damage. In your daily life, you should be vigilant and strengthen your safety awareness.
4. The Company is not responsible for any indirect, incidental, special punitive damages, claims, loss of property or loss of any data or documents. To the maximum extent permitted by law, the liability for compensation of company is not exceed than the amount you paid for this product.

