

goodnature®

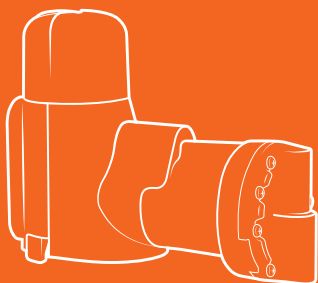

# QUICK START GUIDE

---

A24 Trap

Trapping made easy

## YOUR TRAP - A24

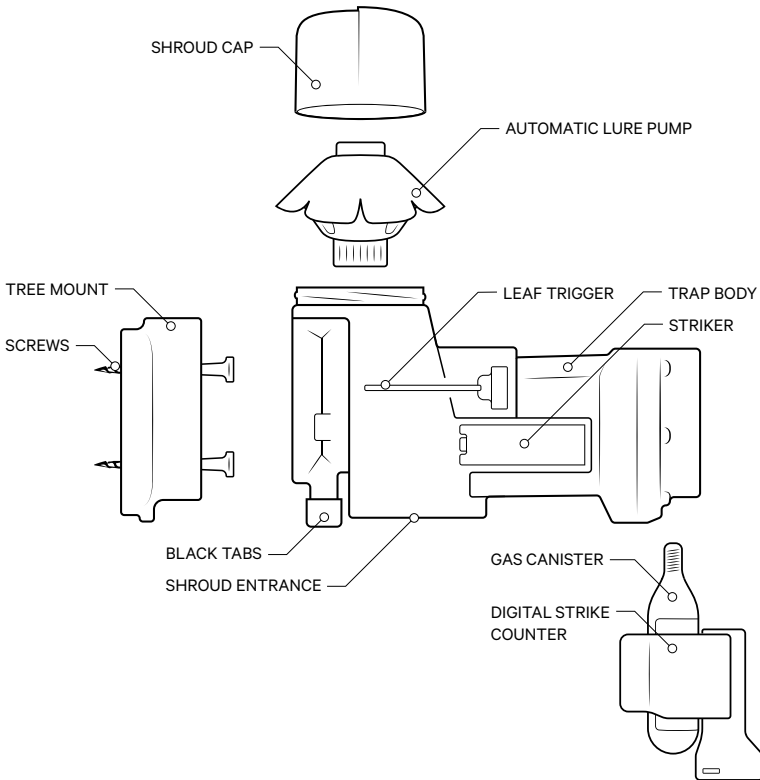

### YOUR CONSTANT CONTROL SYSTEM

Congratulations! You are now the owner of the world's most advanced pest control technology. Goodnature's self-resetting trapping system is designed so that your trap waits for the pest to activate it, instead of waiting for you to clear and re-lure it after each strike. We call this a constant control system – one that suppresses the existing pest population and is always available to manage the inevitable reinvasion.

Powered using compressed CO<sub>2</sub> gas, Goodnature technology combines superb design engineering principles and behavioural science with the highest manufacturing standards to deliver a trap that will kill up to 24 times per Gas Canister.

Our lures are developed to be long life to ensure optimal field performance for minimal maintenance effort. Because they are toxin-free there is no risk of secondary poisoning to non-target species such as wildlife, pets, livestock and working animals. The Leaf Trigger and the Strike mechanism gives the Goodnature A24 its certified A-Class humane status.

This quick start guide has been developed to help you get the best results you can and we hope you enjoy it. Furthermore we appreciate any feedback you'd like to give us. Go to our website for more information.

Happy trapping!

## IN THE BOX

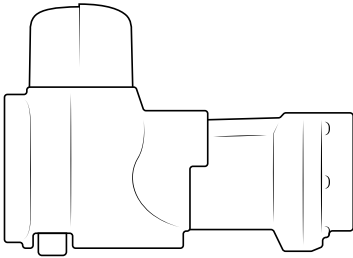

A24 TRAP

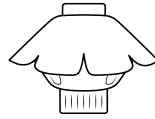

AUTOMATIC LURE PUMP

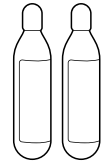

2 x GAS CANISTERS

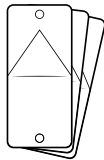

3 x DETECTOR CARDS  
(for rats & mice)



DIGITAL STRIKE COUNTER  
(optional)

## HOW IT WORKS

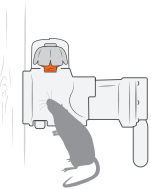

### SNIFF SNIFF

Targeted long life lure attracts rodents into the trap.



### KAPOW!

Rodent moves the trigger to get to the lure, firing the trap.

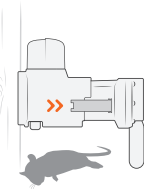

### AUTO-RESET

The trap clears and resets immediately after an A-Class humane kill.



### SNIFF SNIFF...

The long life lure continues to attract rodents for constant control.



### SCAVENGED

Different species scavenge the dead carcasses from below the trap.

## FIND THE BEST TRAPPING LOCATION

### USE DETECTOR CARDS BEFORE INSTALLING YOUR TRAPS

Goodnature's Rodent Detector Cards tell you the best place to install your A24 traps. Screw them around your backyard, shed etc. and the rodents will gnaw on them, showing you a place where they are more interested in and can be trapped faster.

### WHY GOODNATURE DETECTOR CARDS WORK

Although you may see signs of rodents such as droppings, diggings or even seeing them scuttling in places; these are not always locations where a rodent will enter a trap. Rodents will investigate food, and therefore a trap, in places where they feel safe. Goodnature's Detector Cards contain toxin-free lure, which also helps to pre-feed your sites.

### SETTING YOUR DETECTOR CARDS

First, fold the Detector Card in half with the orange triangular Detection surface facing out. You should see the lure squeeze out below the orange triangular Detection surface. The Detector Card is now primed and ready to install.

Position the Detector Card so the bottom edge is fist height (roughly 8 cm) off the ground. The orange triangle Detection surface should be facing out.

Drive the supplied screw through both holes in the card and into the tree, post or wall. The screw should be in firmly but take care not to force the card flat against the tree. If necessary pull the bottom edge of the Detector Card a few millimetres away from the tree or post. This allows rodents to get their mouths around the card and leave bite marks on the Detection surface.

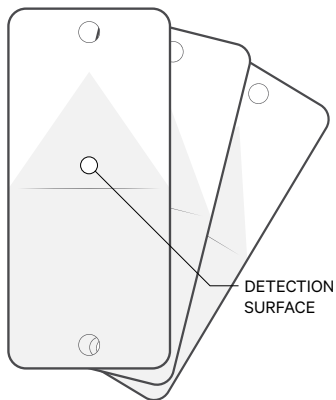
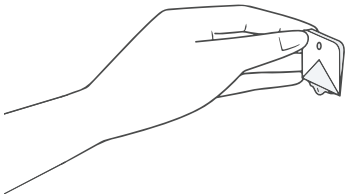

### DETECT FOR 3 NIGHTS

Leave your Detector Cards in place for three nights before analysing. If you have rodents that are interacting with the Detector Card you will see teeth marks on the Detection surface.

Set your Goodnature A24 at the same sites where rodent interaction has been positively detected.

**Now you've found the best sites to set your traps.**

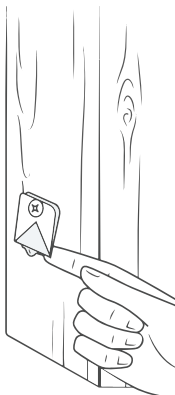

## IDENTIFYING BITE MARKS

### MOUSE

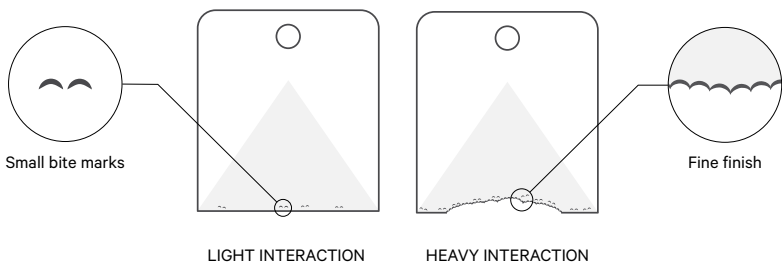

### RAT

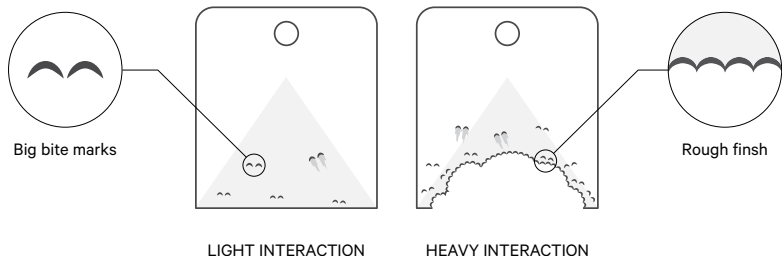

### HOW TO IDENTIFY RODENT BITE MARKS

Goodnature Detector Cards identify rodents by their unique bite marks.

Both rats and mice are meticulous nibblers. They will often focus on one area, occasionally removing some plastic. A longer jaw length allows rats to make marks further into the Detection surface from the edge than mice can.

The key difference between a rat and mouse bite mark is that mice have small teeth and jaws that leave very fine marks with a neat finish. Conversely, rats leave a rougher finish and you may see confetti-like litter beneath the card on the ground. Rats can also completely destroy the card with their gnawing.

### NO RODENT INTERACTION?

Either rodents are not present at this site or it is located where they will not interact with the lure and device.

Try waiting a few more days or moving the card to a different location.

### OTHER BITE MARKS YOU MIGHT SEE

We know that what we are trying to control in one country is often protected and loved in other countries.

If you are unable to identify the markings on a Detector Card, read the 'Identifying bite marks' document on our website support section to help determine what species is present.

## INSTALLING YOUR TRAP

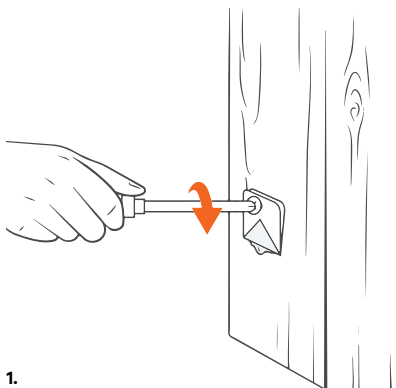

### 1. INSTALL YOUR DETECTOR CARDS

To determine the best location for your trap, set out your Detector Cards and leave in place for three days. Install your trap where rodent interaction has been positively detected (see previous page).

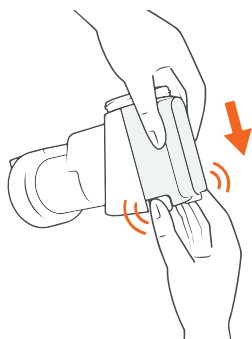

### 2. SEPARATE TREE MOUNT FROM THE TRAP BODY

Using your forefinger and thumb, press the Black Tabs inwards and ease the orange Tree Mount along and off the Trap Body.

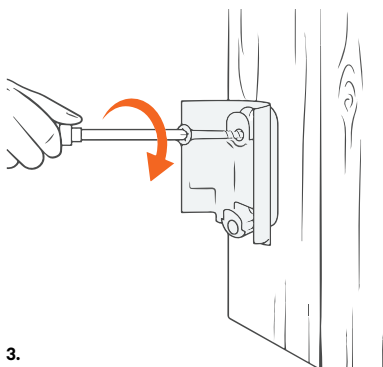

### 3. ATTACH THE TREE MOUNT

Using a screwdriver, screw in the orange Tree Mount 12 cm above the ground onto a straight tree or post. **Do not overtighten.**

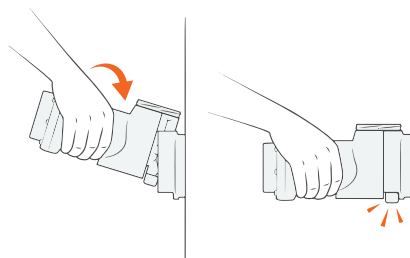

### 4. ATTACH THE TRAP BODY TO THE TREE MOUNT

Tilt the Trap Body backwards slightly and lower it onto the top locking tab of the Tree Mount. As you press downwards the Trap Body will be guided in toward the Tree Mount and lock in with a click.

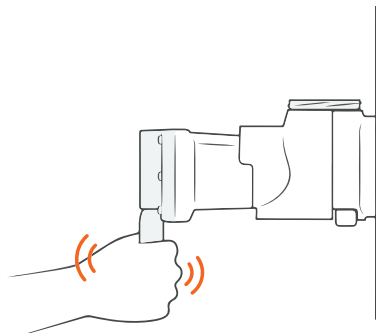

**5.**  
**POWER/PRESSURISE THE TRAP**

Take the Gas Canister and remove the black cap. Be careful to keep the screw thread clean and free of debris. Screw in the canister until firmly sealed. **Hand tighten only.**

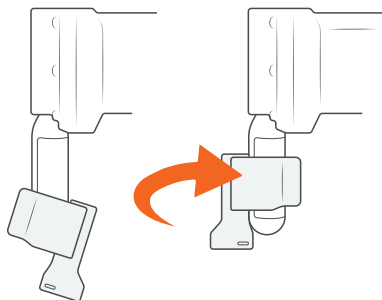

**6.**  
**ATTACH THE DIGITAL STRIKE COUNTER**

If you purchased a Counter with your A24, wet the inside of the rubber strap for lubrication and rotate the Counter anti clockwise as you ease it up the canister. **The Counter display must face directly away from the tree.**

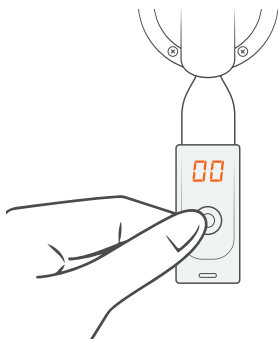

**7.**  
**ZERO THE COUNTER**

Zero the Counter by pressing the button and holding it down until the display shows '00'. The Counter goes to sleep a few seconds after the button is released.

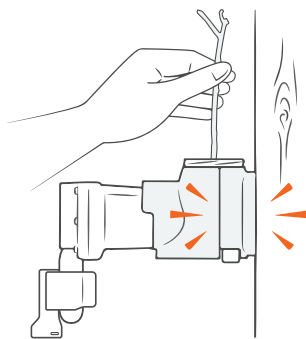

**8.**  
**TEST FIRE YOUR TRAP**

To test fire the trap, reach a pen or twig down through the top of the trap and push sideways on the Leaf Trigger. The Striker will discharge with a bang and then retract. **Keep your hands clear of the Shroud Entrance and always treat the trap as live.**

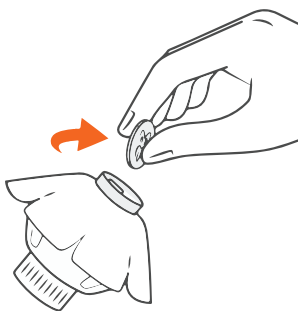

**9.**  
**ACTIVATE THE ALP**

Remove the 10c coin from the top of the ALP just before you put it into the Shroud Cap. This activates the ALP technology which will last for 6 months. Do not remove the ALP Lid yet. **It is vital you remove the coin or the ALP will not activate.**



**11.**  
**REMOVE ALP LID**

Now remove the ALP Lid. A small amount of lure may be forced out, that's fine – there's still enough lure for 6 months. Use the excess lure as pre-feed by wiping it below the trap to immediately attract any passing pests.

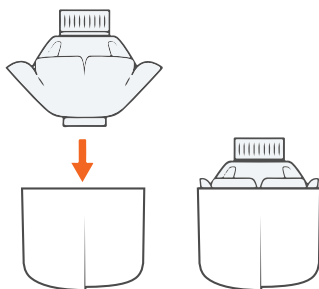

**10.**  
**NEST ALP INTO SHROUD CAP**

With the ALP activated, use your thumbs and forefingers to shape the ALP into the Shroud Cap's form. It will be a tight fit. Be careful not to push it in too far. Align the ALP so that the skirting sits about 3 mm proud of the Shroud Cap rim so it can screw into the Lure Cradle thread.

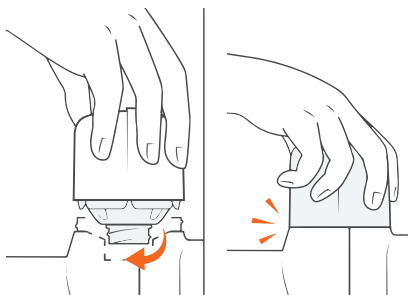

**12.**  
**SCREW & SECURE THE SHROUD CAP & ALP**

Lightly place the Shroud Cap with the ALP into the Lure Cradle and partially screw the ALP into the internal thread of the Lure Cradle. Once the ALP is engaged into the Lure Cradle, secure the Shroud Cap onto the trap. The ALP is now set and active!



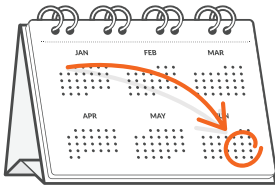

**13.**  
**RECORD INSTALLATION DATE**

Your ALP will need replacing in 6 months time. Record the installation date to remind you. After 6 months, replenish your traps' gas and lure. You'd be surprised how many people will forget. There's no need to handle the ALP until it needs replacing.



**15.**  
**REPLACE GAS & LURE EVERY 6 MONTHS**

Remember, Goodnature traps are about constant control. Make sure you stick to the 6 monthly maintenance regime of replacing your gas and lure (ALP). 6 months will pass soon enough, so make sure you have gas and lure on-hand for ongoing success.

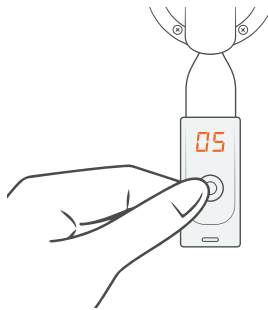

**14.**  
**CHECKING THE COUNTER**

To check the tally on the Counter, quickly press and release the button. The display will show the number killed. **Pressing and holding the button down zeroes the Counter.**

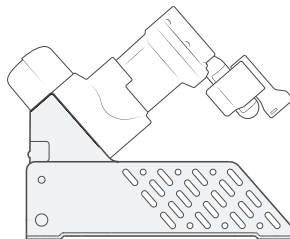

**16.**  
**A24 TRAP STAND**

The A24 Trap Stand is an accessory that gives you flexibility to target a greater range of areas and the ability to fine tune your network by being able to shift your trap easily.

## MAINTAINING YOUR TRAP

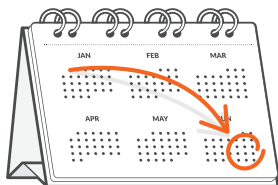

### REPLACE THE GAS & LURE EVERY 6 MONTHS

Every 6 months, change the lure (ALP) and replace the Gas Canister, regardless of how many kills you've counted. This ensures your trap is attractive to pests, pressurised and always available.

Remember, any quality, humane pest control device is only as effective as the quality of the lure used to attract the pest. It is the lure that motivates the target pest to enter and activate the trap.

### WARNING

To safely remove the Gas Canister follow steps 1-3 on the opposite page. Although the Gas Canister has been removed the trap may still be live with one charge remaining in its chamber. Once you have de-pressurised the trap, it is safe to replace the Gas Canister.

Keep a record so you know when you need to replace the gas and lure. Use the table below, put a note in your calendar or set an alarm on your phone.

	<b>Date Installed</b>	<b>6<sup>TH</sup> Month Replacement</b>	<b>Trap Location</b>
<b>E.g.</b>	03/09	09/03	Back of Garden Shed
<b>Trap 1</b>	_____	_____	_____
<b>Trap 2</b>	_____	_____	_____
<b>Trap 3</b>	_____	_____	_____

## MOVING YOUR TRAP

### 1. DE-COUPLE

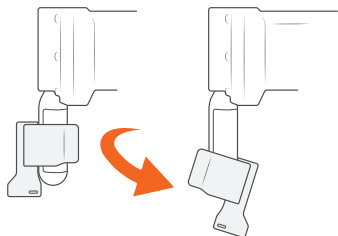

### 3. DE-PRESSURISE

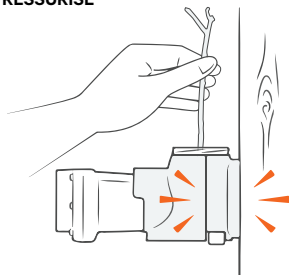

### CONSTANT CONTROL

Rather than move your traps, it is better to add to the trapping network and increase your pest free area. However, if you need to move your trap or have found a better location for it, then it is very important that you follow the instructions below.

Goodnature develops products for the constant control of invasive pests. This is achieved by establishing a permanent network of traps to knock down target populations and then be ready for the inevitable reinvasion. Build your network.

### HOW TO DO IT SAFELY

To move the trap, first **de-couple** the Counter and then **de-gas** the trap by unscrewing the current Gas Canister from the trap. You may experience the noise of the remaining gas in the canister escaping, which may cause the canister to freeze rapidly. Be careful when handling frozen canisters.

### 2. DE-GAS

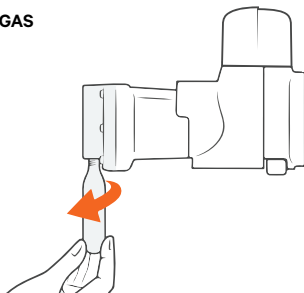

### 4. DETACH

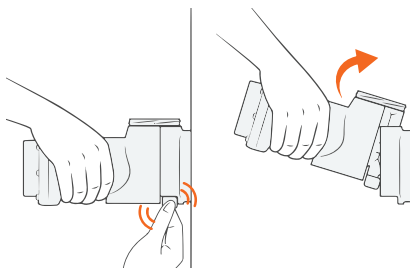

### WARNING

Although the Gas Canister has been removed the trap may still be live (pressurised) with one charge remaining in its chamber. To **de-pressurise** the trap, firstly remove the Shroud Cap and the ALP, then reach a pen or twig down through the top of the trap and push sideways on the Leaf Trigger. The Striker will discharge with a bang and then retract.

Always treat the trap as live until you have de-gassed and de-pressurised it. If the trap doesn't fire when triggered, the trap has successfully been de-pressurised.

With the trap de-pressurised, your trap is now safe to **detach** from the Tree Mount. Place your palm beneath the Shroud Entrance and using your thumb and forefinger, squeeze the Black Tabs and with upward pressure pull the trap up and off the Tree Mount.

**Always keep fingers clear of the Shroud Entrance.**

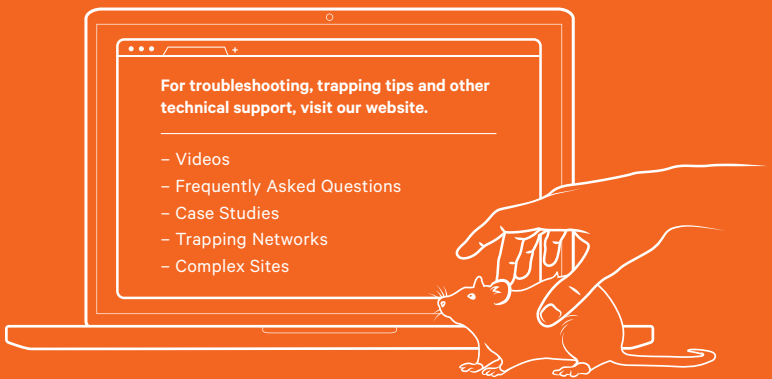

Please recycle after use. This material has been printed using vegetable oil-based/mineral oil-free inks. Printed on uncoated woodfree paper produced from eucalyptus fibres and sourced from sustainable forests.