



**GOTRAX**

# G2 Scooter

COMMUTING ELECTRIC SCOOTER

**USER MANUAL**



**Congratulations  
on your purchase!**

**GOTRAX**

This user manual will help you assemble and operate your new electric scooter. Be sure to read **ALL OF THE INFORMATION** in this manual before riding.

**NOTE TO ALL RIDERS UNDER 18 YEARS OF AGE:** It's very important that you get parental permission before riding your scooter.





# Don't Ride Until You Read This:



**ALWAYS** wear a helmet when riding your electric scooter.



Make sure your scooter has a **full battery** before taking it out to ride.



**Always** be aware of local road laws, and follow them.



**Do not** ride the scooter under the influence of drugs or alcohol.



**Always** respect pedestrians.



**Do not** ride under wet conditions. The scooter may slide from under your feet causing injury. Wet conditions may damage the electronics and void the warranty.



# Warning Message

1. **Avoid water** - The scooter is not waterproof. The electronics may be damaged due to water and water damage is not covered by our warranty. Riding in wet conditions is also very dangerous and may result in injury.
2. **Abuse** - We do not cover physical damage due to negligent care and extreme riding.
3. **Whenever you ride the Gotrax scooter** , you risk severe injury or even death from loss of control, collisions, and falls. Use caution and ride at your own risk.
4. **Do not** modify the product from the manufacturers original design.
5. **Keep** hands and all body parts away from moving parts while operating the scooter.
6. **Before riding** - be sure to check the scooter over and make sure the scooter is operating correctly before each use.
7. **Before riding** - be sure to check that the braking system is functioning properly; also be sure to check that all safety labels are in place and you understand the safety warnings.
8. **Before riding** - be sure that any and all axle guards, chain guards, or other covers or guards supplied by the manufacturer are in place and in serviceable condition.
9. **Before riding** - be sure to check that the tires are in good condition, inflated properly, and have sufficient tread remaining.
10. The electric scooter should never be used by children under the age of 13.
11. **Maximum Speed** - Your electric scooter goes the maximum speed of 15.5 mph.
12. **Never** exceed the 220 lb maximum load rating.



# Unpack

You should find each of these items in your box:

1. Electric Scooter
2. Console & Handlebars
3. Approved Power Adapter / Charging Unit
4. Allen Wrench
5. Screws
6. Safety Pin

1



2



3



4



5



6



Remove all packaging material, then inspect each item for any accidental damage that may have occurred during shipping.



# Get To Know Your Scooter

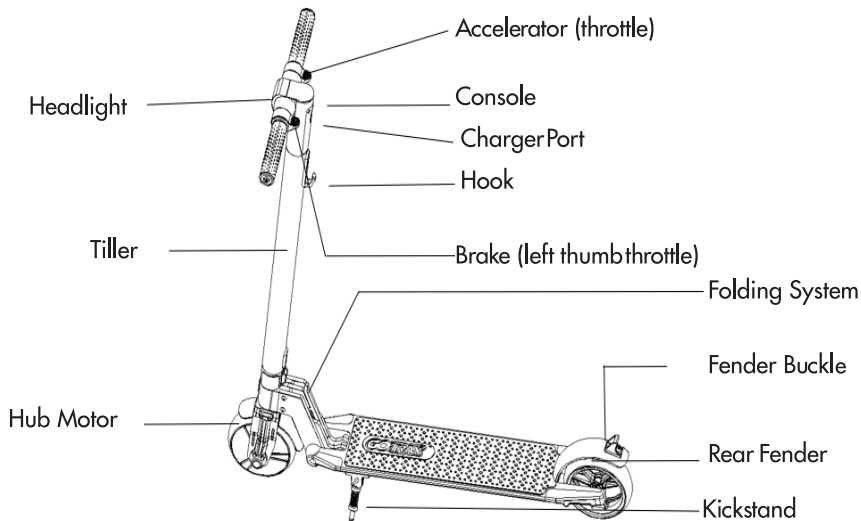

The electric scooter comes partially assembled.

## Specifications

Top Speed:	15.5 mph
Distance per Charge:	7 miles
Battery Type:	36V 4.0Ah
Battery Charger:	DC 42V 0.85A
Charge Time:	4.5 - 5 hours
Power Requirements:	AC 100 ~ 240V 50/60Hz 1.5A



# Assemble Your Scooter

1

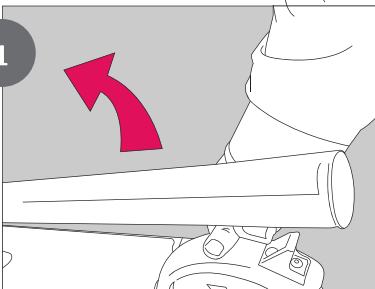

## Unfold Scooter & Lock in Upright Position

Press down on the rear fender, separate the folding hook and fender buckle, then lift the tiller upright (as shown in the figure). Once the scooter is locked in the upright position, verify by gently trying to fold.

2

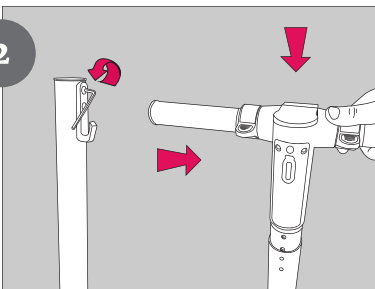

## Detach Hook and Remove Plug Inside Tiller

Use the Allen wrench to loosen the screws located at the hook and detach. Once you've removed the hook and screws, make sure to remove the plug inside of the top of the tiller.

3

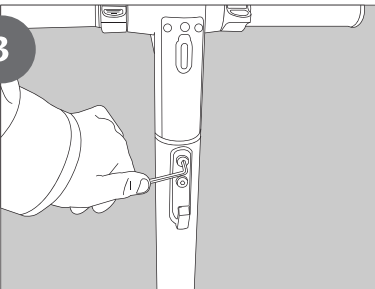

## Place Console Into Tiller & Reattach

Place the console into the top of the tiller. Once the console is attached, use the Allen wrench to attach the hook back to the tiller with the two screws.





# Charge Your Scooter

Before using the scooter, you must fully charge the battery.

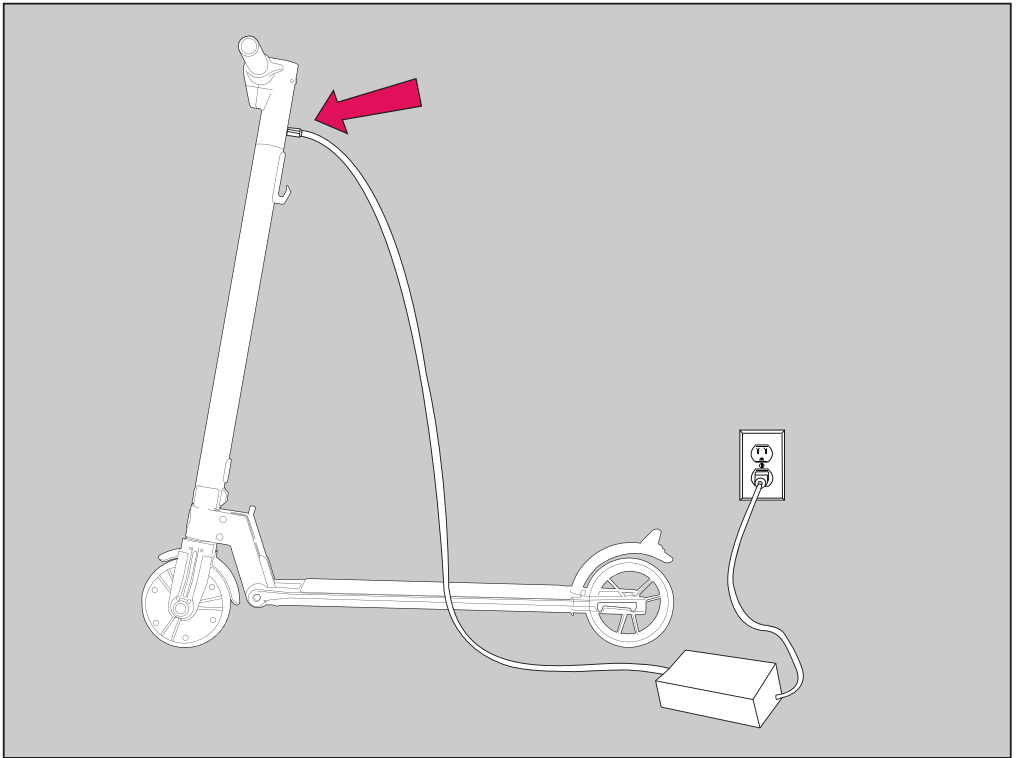

1. Open the rubber charging port cover.
2. Insert the charging plug into the port.
3. The charger box will have a green light when fully charged and a red light when charging.
4. When you are done charging be sure cover the charging port to keep it clear of dust and debris.



# Scooter Console Functions

**To power the scooter on**, press and hold the red button for 1 second.

**To power the scooter off**, press and hold the red button for 5 seconds.

**To power the headlight on or off**, press the red button for 1 second while the scooter is powered on.

**The console on the Scooter displays speed in MPH** , Battery life, and headlight on/off.

**When the scooter is power on**, press the power button **3 times to switch speed unit display**. The default speed unit is MPH, the console will display km/h after switching.

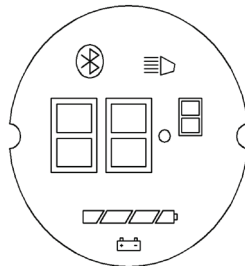
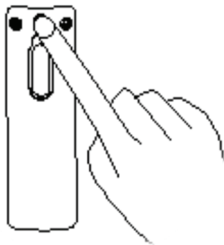



# Riding Tips

1. You will want to start riding your scooter with one foot on the platform and one foot on the ground. Use your foot on the ground to push off and at the same time, press the throttle button to begin movement.
2. Press the brake-throttle to slow down or stop. For quicker stopping step on the rear fender foot brake.
3. The scooter performs best when on a smooth surface e.g. car parks, smooth roads, footpaths, & bike lanes.
4. Always clean your scooter (wheels, platform, etc.), it's a machine and it needs to be maintained.
5. Do not press the throttle while walking with the scooter beside you.
6. Be aware of the terrain you are riding on, watch out for curbs and obstacles!
7. **Cruise Control:** To activate the cruise control press the right-hand throttle down for 10 seconds. To deactivate the cruise control press either the right-hand throttle or brake button to deactivate the cruise control.
8. **CAUTION :** The left paddle control on the console controls the motor's Electro-Magnetic brake. This brake is energized by the operation of the motor and will NOT be 100% effective until the motor has been in operation for 30 seconds

# Putting Your Scooter Away/Folding

Before folding the scooter, make sure that the scooter is powered off and remove the safety pin.

Pull the Tiller towards the back wheel, as shown in the figures. Insert the hook on the tiller into the loop on the rear fender buckle. You may hear a click which indicates that you were successful in folding and locking the scooter.

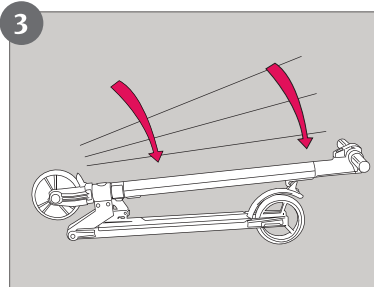
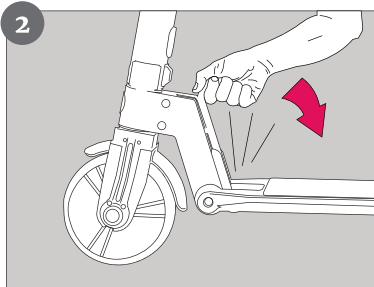
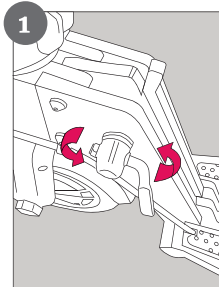

# Maintenance & Repair

**If you regularly clean and maintain your electric scooter, it will extend its life.**

**Cleaning and storage:** If the scooter is dirty, wipe it clean with a soft damp cloth.

**Brake Adjustments & Service:** If you notice you need brake adjustments or any service on your scooter, contact our customer service team and we will adjust and repair your scooter. Do not repair your scooter yourself, this can void your warranty and you risk damaging the scooter.

**DO NOT** use alcohol, gasoline, kerosene, or other corrosive chemical solvents to clean the scooter. It can severely damage the appearance and structure of the scooter. Please do not use a pressure washer as it may also cause damage to the electronics.

**Storage:** When you're not using your scooter store in a dry and cool location. Avoid storing your scooter outdoors because sun exposure can damage its appearance and may cause wear on the life of the battery and tires.

**Tightening the Tiller:** If you notice that the tiller is loose or wiggles while riding, you can tighten the screws. Open the plastic cover, and use the Allen wrench to tighten the screws.



# Safety Lock Instructions

- 1. Unfolding:** Lift the tiller in the upright position and insert the safety lock. Rotate the safety lock clockwise to tighten the safety lock before you ride!
- 2. Folding:** Rotate the Safety Lock counterclockwise to pull out the safety lock. Fold the scooter and then insert the safety lock and rotate clockwise to lock the safety lock again.

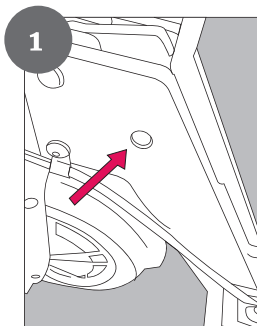

**1**  
The hole is located next to the red lever on the bottom of the scooter.

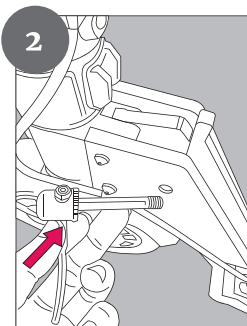

**2**  
Arrow points to the Safety Pin (pictured).

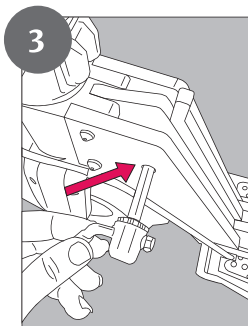

**3**  
Insert the Safety Pin.

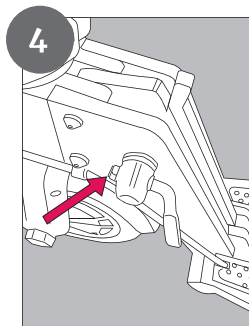

**4**  
Twist the Safety Pin into the hole and secure it. Make sure it twists firmly in place.



# Battery Information

Only use the approved Gotrax power adapter to charge your scooter, others may cause risk of fire & equipment may be damaged.

Improper disposal of used batteries may seriously pollute the environment. Please comply with local disposal regulations.

Make sure to store your scooter and power adapter in conditions that do not exceed 122 degrees fahrenheit or below -4 degrees fahrenheit.

**Warning** - Risk of Fire - No User Serviceable Parts, The prolonged exposure to UV Rays, Rain and the Elements may damage the enclosed materials, store indoors when not in use.



# Troubleshooting

We frequently update our user manuals at [gotrax.com](http://gotrax.com), and reserve the rights to update and change manuals online.

**Please contact our customer service team if you are experiencing problems or need more detailed information. They can be reached at [gotrax.com](http://gotrax.com)**

# Warranty

For warranty information, please visit us at [www.gotrax.com](http://www.gotrax.com).





WWW.GOTRAX.COM

**#RideGOTRAX**





# **GOLABS, INC**

GOTRAX.com  
2201 Luna Rd.  
Carrollton, TX 75006