

JumpSport®

120 HOME FITNESS TRAMPOLINE

Owner's Manual

Assembly, Installation, Care, Maintenance, and Use Instructions.

⚠ WARNING Read these materials prior to assembling and using this trampoline.



Product May Vary Slightly From Pictured.

CAUTION:
Weight on this product should not exceed 250 lbs.

This Product is Distributed Exclusively by



2040 N Alliance Ave, Springfield, MO 65803
Customer Care
1 (800) 375-7520
www.staminaproducts.com

⚠ WARNING

1. **DO NOT** attempt or allow somersaults. Landing on the head or neck can cause serious injury, paralysis, or death even when landing in the middle of the bed.
2. Do not allow more than one person on the trampoline.
3. Use trampoline only with mature knowledgeable supervision.
4. Exercise can present a health risk. Consult a physician before beginning any exercise program with this equipment.
5. If you feel faint or dizzy, immediately discontinue use of this equipment.
6. Keep others and pets away from equipment when in use.
7. Always make sure all parts are securely tightened prior to each use.
8. Weight on this trampoline should not exceed 250 lbs.
9. This trampoline is not recommended for children.

Serious bodily injury or death can occur if the above warnings are not followed or if this equipment is not assembled and used according to all instructions.

When calling for parts or service, please specify the following numbers:

Model#: 35-1820

S/N: _____

MADE IN CHINA

© 2020 Stamina Products, Inc.
2020, 06

TABLE OF CONTENTS

Safety Instructions	2	Workout Program	12
Before You Begin	4	Warm-Up and Cool-Down	13
Equipment Warning, Caution & Notice Labels	5	Basic Workout	14
Assembly Instructions	6	Product Parts Drawing	16
Installation Instructions	9	Parts List	17
Care and Maintenance Instructions	9	Warranty	18
Use Instructions	10	Fax/Mail Ordering Form	19
Conditioning Guidelines	11		

SAFETY INSTRUCTIONS

⚠ WARNING Cancer and Reproductive Harm www.P65Warnings.ca.gov

⚠ WARNING Consult your physician before starting this or any exercise program. This is especially important if you are over the age of 35, have never exercised before, are pregnant, or suffer from any health problem. This product is for home use only. Do not use in institutional or commercial applications. Failure to follow all warnings and instructions could result in serious injury or death.

⚠ WARNING The Elastic Cords(6) contain natural rubber latex which may cause allergic reactions.

⚠ WARNING To reduce the risk of serious injury, read the following Safety Instructions before using the JumpSport® 120 Home Fitness Trampoline.

1. Save these instructions and ensure that other exercisers read this manual prior to using the JumpSport® 120 Home Fitness Trampoline for the first time.
2. Misuse and abuse of this trampoline is dangerous and can cause serious injuries.
3. Trampolines, being rebounding devices, propel the performer to unaccustomed heights and into a variety of body movements.
4. **The JumpSport® 120 Home Fitness Trampoline is for home use only. Do not use in institutional or commercial applications. Failure to follow this warning could result in minor or moderate injury.**
5. All purchasers and all persons using the JumpSport® 120 Home Fitness Trampoline must become familiar with the manufacturer's recommendations for proper assembly, use and care of the JumpSport® 120 Home Fitness Trampoline, as well as being alert to the performer's own limitations in the execution of trampoline skills. Assembly Instructions, Safety Instructions, Trampoline Fundamentals, and Warning Labels are included to promote safe, enjoyable use of the JumpSport® 120 Home Fitness Trampoline. Make sure that it is properly assembled and tightened before use.
6. The owner and supervisors of the trampoline are responsible to make all users aware of the Safety Instructions and practices in the use instructions.
7. Place the JumpSport® 120 Home Fitness Trampoline on a level surface before use.
8. Use the JumpSport® 120 Home Fitness Trampoline in a well lighted area. Artificial illumination may be required for indoor or shady areas.
9. Do not place the JumpSport® 120 Home Fitness Trampoline on an elevated surface. The JumpSport® 120 Home Fitness Trampoline should be at floor level or ground level.
10. Inspect your JumpSport® 120 Home Fitness Trampoline before each use. Replace any worn, defective, or missing parts.
11. Make sure the floor or ground around the JumpSport® 120 Home Fitness Trampoline is clear of all objects that may cause injury if you step on them when dismounting.
12. Adequate overhead clearance is essential. Provide adequate clearance for ceilings, ceiling lights, ceiling fans, wires and tree limbs. Failure to provide adequate head clearance can result in head or neck injury.
13. Do not allow children to use the JumpSport® 120 Home Fitness Trampoline. The JumpSport® 120 Home Fitness Trampoline is not a toy, it is for use by adults only. Use the trampoline only with mature knowledgeable supervision.
NOTE: The TRAMPOLINE USE INSTRUCTIONS sign is a standard sign that is supplied to comply with ASTM F381. This sign indicates that trampolines are suitable for use by children over six years of age. However, the JumpSport® 120 Home Fitness Trampoline is not recommended for children of any age.
14. Lateral clearance is essential. Place the JumpSport® 120 Home Fitness Trampoline away from walls, structures, fences, play areas, furniture, and other exercise equipment. Maintain a clear space on all sides of the trampoline.
15. Keep small children and pets away from the JumpSport® 120 Home Fitness Trampoline at all times including use and assembly of the JumpSport® 120 Home Fitness Trampoline.
16. The weight limit on the JumpSport® 120 Home Fitness Trampoline is 250 pounds.
17. Do not use the JumpSport® 120 Home Fitness Trampoline with socks only. Good traction is very important when mounting, using, and dismounting the JumpSport® 120 Home Fitness Trampoline. Bare feet are acceptable but we recommend good footwear with rubber non-skid soles such as walking, running or cross-training shoes.
18. Wear appropriate clothing when exercising; do not wear loose clothing that could become caught in the JumpSport® 120 Home Fitness Trampoline.
19. The JumpSport® 120 Home Fitness Trampoline should be used by only one person at a time.
20. Remove any obstructions from beneath the JumpSport® 120 Home Fitness Trampoline.
21. The surface of the bed should be dry.
22. Be careful to maintain your balance when mounting, using, dismounting, or assembling the JumpSport® 120 Home Fitness Trampoline. Loss of balance may result in a fall and serious bodily injury.
23. Do not step on the safety pad when mounting, using or dismounting the JumpSport® 120 Home Fitness Trampoline.
24. Do not attempt any gymnastic or acrobatic maneuvers on the JumpSport® 120 Home Fitness Trampoline.
25. Stop exercising before attempting to dismount the JumpSport® 120 Home Fitness Trampoline. To avoid sprains and broken bones, come to a complete stop before dismounting.
26. Use the JumpSport® 120 Home Fitness Trampoline only as described in this manual.
27. Always store the JumpSport® 120 Home Fitness Trampoline indoors in a dry place.
28. Secure the JumpSport® 120 Home Fitness Trampoline against unauthorized and unsupervised use.

EXTEND YOUR PARTS WARRANTY TO 180 DAYS FROM THE DATE OF PURCHASE. REGISTER YOUR PRODUCT.



**NEED HELP?
CONTACT US FIRST
1 (800) 375-7520
customer.care@staminaproducts.com**

Hi! From all of us here at Stamina Products, thank you for your purchase. We know that you have big fitness goals in mind and we are here to help you along. Call us, email us, or send us a message on Facebook. Be sure to contact us if you have any questions on your new product. We look forward to hearing from you!

With your body in mind,
Stamina Customer Care

To enact your extended warranty and to help us better serve you, please go online and register your new product.

register.staminaproducts.com

It is quick and easy to register online, but if you're a little old school or just need a reason to raise that little flag on your mailbox, fill out the info on the last page of this manual and mail it in.



ONLINE

customer.care@staminaproducts.com
www.staminaproducts.com



TELEPHONE

1 (800) 375-7520



FAX

(417) 889-8064



MAIL

Stamina Products, Inc.
ATTN: Customer Care
2040 N Alliance Ave
Springfield, MO 65803

 facebook.com/StaminaProducts
facebook.com/AeroPilates

CUSTOMER CARE HOURS:
Monday-Thursday, 7:30 AM-5:00 PM, Central Time
Friday, 8:00 AM-3:00 PM, Central Time

BEFORE YOU BEGIN

Thank you for choosing the **JumpSport® 120 Home Fitness Trampoline**. We take great pride in this quality product and hope it will provide many hours of quality exercise to make you feel better, look better, and enjoy life to its fullest.

It's a proven fact that a regular exercise program can improve your physical and mental health. Too often, our busy lifestyles limit our time and opportunity to exercise. The **JumpSport® 120 Home Fitness Trampoline** provides a convenient and simple method to begin your journey of getting your body in shape and achieving a happier and healthier lifestyle.

Before reading further, please review the drawing below and familiarize yourself with the parts that are labeled. Locate the serial decal on the product and write the serial number on the cover of the manual in the space provided. See page 5 for an image of the serial decal. Model number and serial number are required when

calling for assistance.

Read this manual carefully before using the **JumpSport® 120 Home Fitness Trampoline**.

Providing you with a quality product is Stamina's top priority. However, sometimes there could be a missing or incorrectly sized part. If you have any questions or problems with the parts included with your **JumpSport® 120 Home Fitness Trampoline**, please do not return the product. Contact us **FIRST!**

If a part is missing or defective, please contact Customer Care for assistance. Call us toll free at 1-800-375-7520 (in the U.S.) or live chat on staminaproducts.com. Our Customer Care Staff is available to assist you from 7:30 A.M. to 5:00 P.M. (Central Time) Monday through Thursday and 8:00 A.M. to 3:00 P.M. (Central Time) on Friday.

Be sure to have the name and model number of the product available when you contact us.

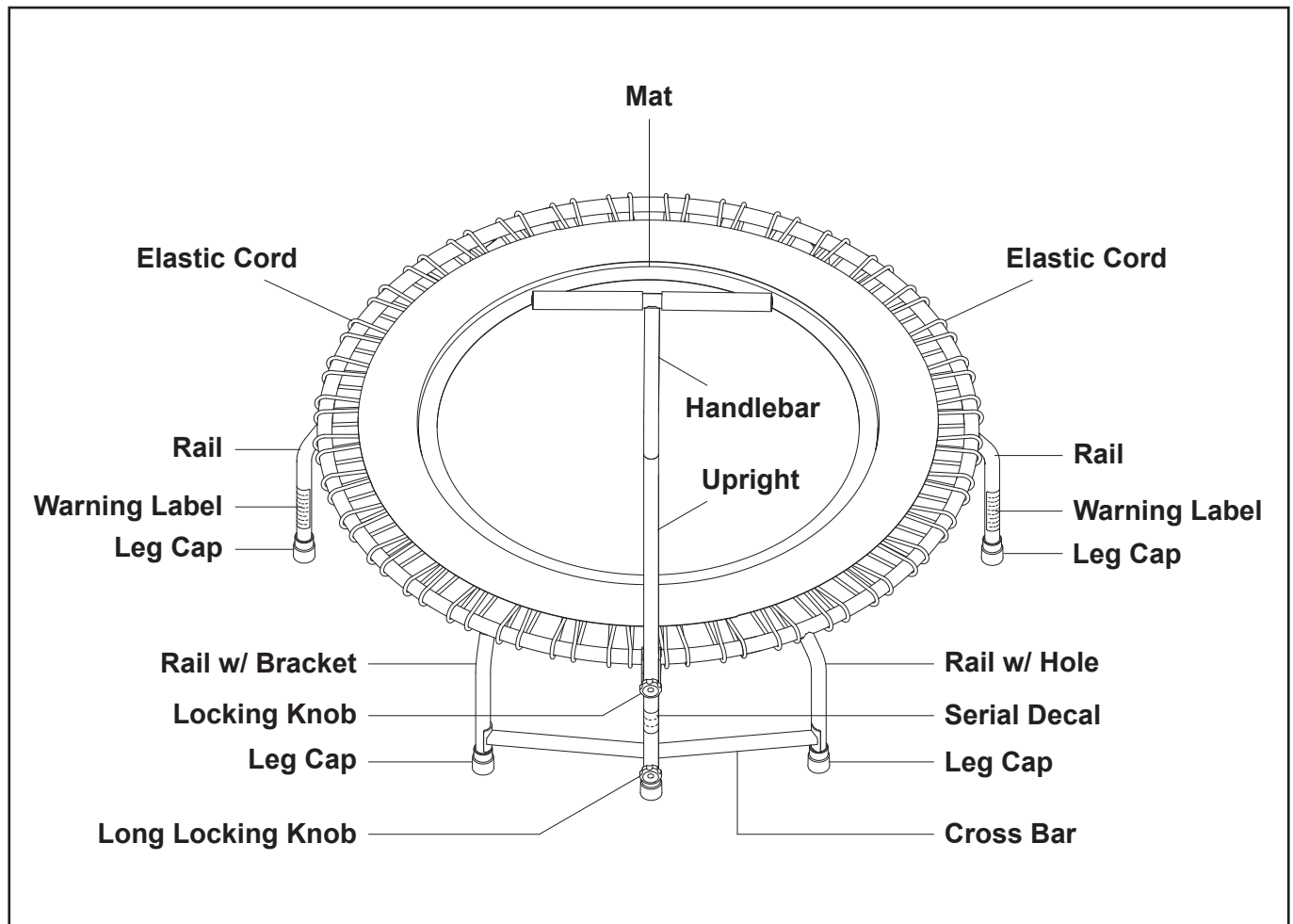

EQUIPMENT WARNING, CAUTION & NOTICE LABELS

This chart is provided to help identify the warning, caution, and notice labels on the **JumpSport® 120 Home Fitness Trampoline**. Please take a moment to familiarize yourself with all of the warning, caution, and notice labels.

WARNING LABEL(23)

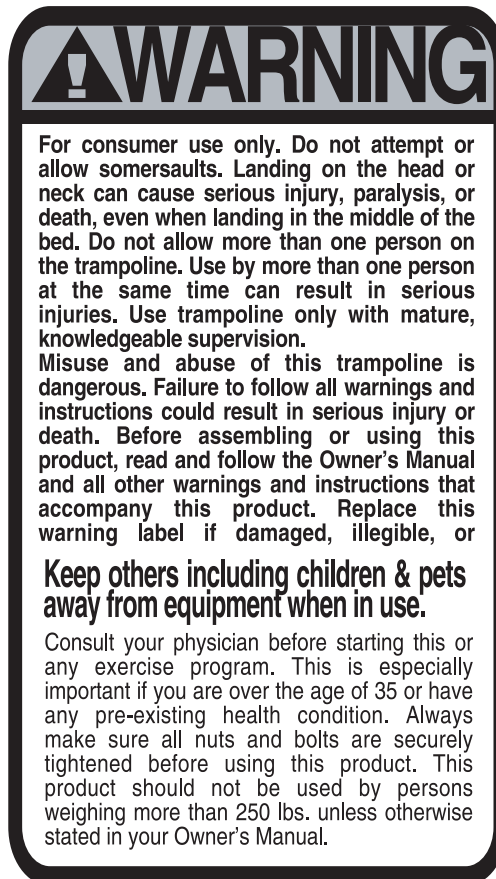

SERIAL DECAL(24)



To best serve you, our Customer Care Representatives will need your serial number. For quick access, write in your serial number on the cover of the manual.

ASSEMBLY INSTRUCTIONS

Place all parts from the box in a cleared area and position them on the floor in front of you. Remove all packing materials from your area and place them back into the box. Do not dispose of the packing materials until assembly is completed. Read each step carefully before beginning. If you are missing a part, please go to staminaproducts.com under the Customer Care section and order the part needed, e-mail us at customer.care@staminaproducts.com, or call us toll free at 1-800-375-7520 (in the U.S.). Our Customer Care Staff is available to assist you from 7:30 A.M. to 5:00 P.M. (Central Time) Monday through Thursday and 8:00 A.M. to 3:00 P.M. (Central Time) on Friday.

Some product parts are fit tested at the factory to ensure proper fit and alignment. Marks in the paint may be noticeable, but are not an indication of damage.

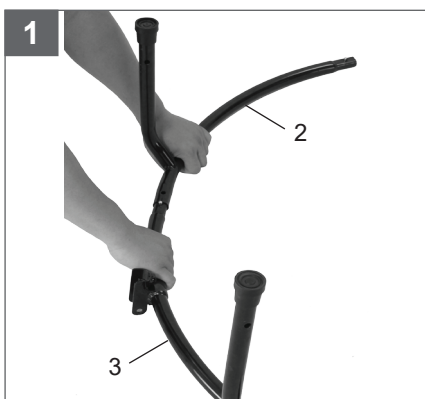

Insert the **RAIL w/ BRACKET(3)** into the **RAIL w/ HOLE(2)** as shown in the picture.



Push down the **BUTTON PIN (10)** when inserting the rails. Make sure the **BUTTON PIN(10)** snaps into the hole in the **RAIL w/ HOLE(1)**.

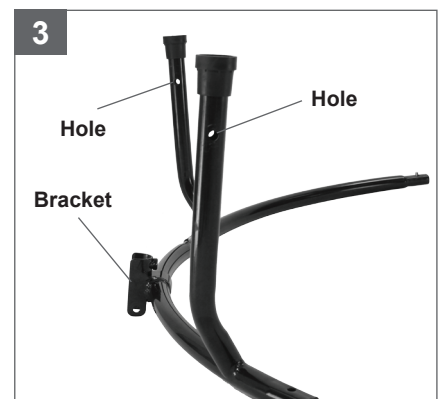

When the first two Rails are assembled, the two legs with holes will look as shown in the picture.

ASSEMBLY INSTRUCTIONS

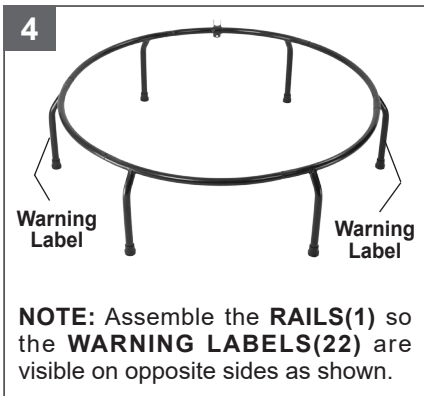

Repeat the previous steps to complete the connection of all the **RAILS(1)**.



Place the **MAT(5)** in the center.



Hook each band onto each leg.



Pull up the **MAT(5)** to the highest position. Now it is ready for assembling the **ELASTIC CORDS(6)**.

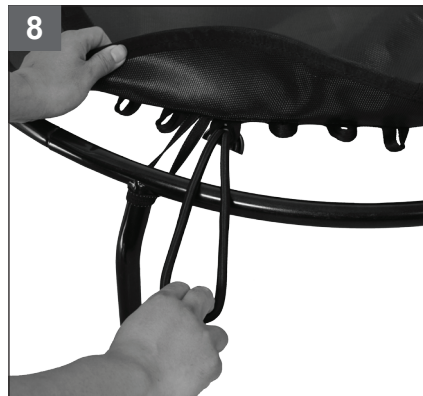

Run the **ELASTIC CORD(6)** through the bottom of the **MAT(5)** and over the top of the rail.



Insert the "wide" end of the Cord Tool through the **ELASTIC CORD(6)** and under the rail. Lock the front end of the Cord Tool onto the plastic holder of the **ELASTIC CORD(6)**.



Push down and rotate the Cord Tool inward to wrap the **ELASTIC CORD(6)** onto the plastic holder and seat the **ELASTIC CORD(6)** into the groove.

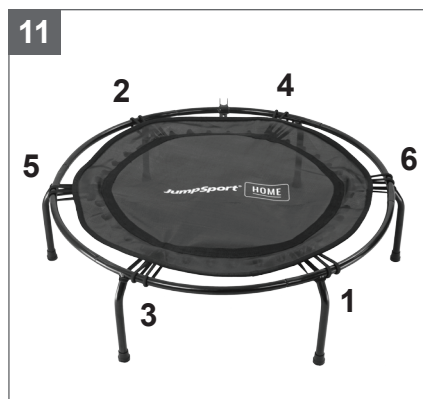

To keep the **MAT(5)** centered, follow the sequence as shown in the picture to attach the **ELASTIC CORDS(6)** to all six rails.

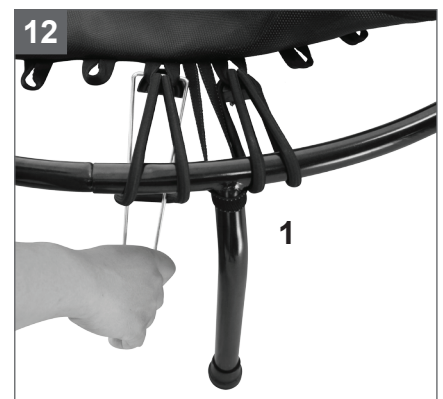

Attach another **ELASTIC CORD(6)** to the opposite side of the leg as shown.

ASSEMBLY INSTRUCTIONS

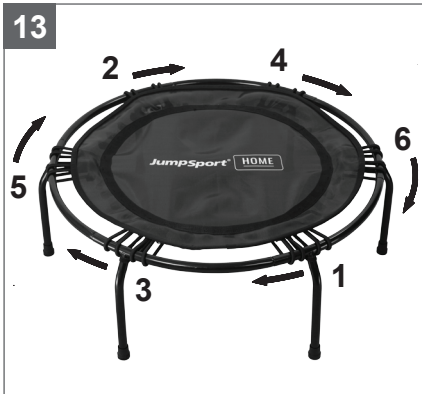

To keep the **MAT(5)** centered, follow the sequence as shown in the picture to attach the rest of the **ELASTIC CORDS(6)**.



When completed, the **ELASTIC CORDS(6)** will look as shown in the picture.



Attach the **CROSS BAR(4)** between the legs of the **RAIL w/ HOLE(2)** and **RAIL w/ BRACKET(3)**.



Lock the **CROSS BAR(4)** to the legs with **BUTTON HEAD BOLTS(M8x1.25x35mm)(13)** and **ARC WASHERS(M8)(14)** on both sides.



Attach the **UPRIGHT(7)** to the **RAIL w/ BRACKET(3)** with **BUTTON HEAD BOLT (M8 x 1.25 x 45 mm) (15)**, **WASHERS(M8)(17)**, and **NYLOCK NUT(M8x1.25)(16)**.

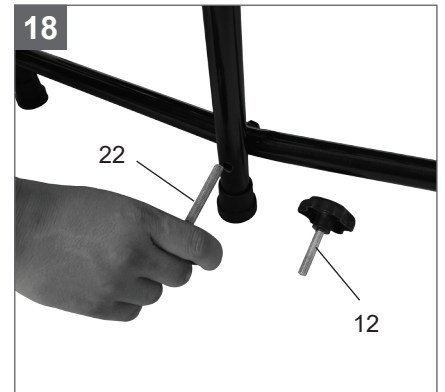

Lock the **UPRIGHT(7)** to the **CROSS BAR(4)** with the **LONG LOCKING KNOB(22)**.



Lock the **UPRIGHT(7)** to the **RAIL w/ BRACKET(3)** with the **LOCKING KNOB(12)**.



Insert the **HANDLEBAR(8)** into the **UPRIGHT(7)**.



Lock the **HANDLEBAR(8)** to the **UPRIGHT(7)** with **BUTTON HEAD BOLTS(M6x1x15mm)(18)** and **ARC WASHERS(M6)(19)**.

ASSEMBLY INSTRUCTIONS

When completed, the trampoline will look as shown in the picture. Stand on the trampoline to ensure all six legs sit flat on the floor. Refer to illustration 22.

Post the **USE INSTRUCTIONS SIGN(25)** in a highly visible and safe location. The **USE INSTRUCTIONS SIGN(25)** shall be placed such that it will be readily visible to the intended user.



INSTALLATION INSTRUCTIONS

1. Adequate overhead clearance is essential. When using your **JumpSport® 120 Home Fitness Trampoline**, be sure to provide clearance for ceiling height, ceiling lights, ceiling fans, wires, tree limbs, and other possible hazards.
2. Lateral clearance is essential. Place the trampoline away from walls, structures, fences, play areas, furniture, and other exercise equipment. Maintain a clear space on all sides of the trampoline.
3. Place the trampoline on a level surface.
4. Use the trampoline in a well lit area.
5. Secure the trampoline against unauthorized and unsupervised use.
6. Remove any obstructions from beneath the trampoline.
7. The owner and supervisors of the trampoline are responsible to make all users aware of practices specified in the use instructions.

CARE AND MAINTENANCE

Inspect the **JumpSport® 120 Home Fitness Trampoline** before each use and replace any worn, defective, or missing parts. The following conditions could represent potential hazards:

1. Punctures, frays, tears, or holes in the mat, elastic bands.
2. Deterioration in the stitching or fabric of the mat.
3. Ruptured or damaged elastic bands.
4. A bent or broken frame.
5. A sagging mat.
6. Sharp protrusions on the frame or suspension system.

STORAGE

To store the **JumpSport® 120 Home Fitness Trampoline**, simply keep it in a clean dry place.

USE INSTRUCTIONS

WARNING

1. DO NOT attempt or allow somersaults. Landing on the head or neck can cause serious injury, paralysis, or death, even when landing in the middle of the bed.
2. Do not allow more than one person on the trampoline. Use by more than one person at the same time can result in serious injuries.
3. Use trampoline only with mature, knowledgeable supervision.
4. This trampoline is not recommended for children.
5. Inspect the trampoline before each use. Make sure the frame padding is properly. Replace any worn, defective, or missing parts.
6. Step on and off the trampoline. It is a dangerous practice to jump from the trampoline to the floor or ground when dismounting, or to jump onto the trampoline when mounting. Do not use the trampoline as a springboard to other objects.
7. Stop bounce by flexing knees as feet come in contact with the trampoline bed. Learn this skill before attempting others.
8. Learn fundamental bounces and body positions thoroughly before trying more advanced skills. A variety of trampoline activities can be carried out by performing the basic fundamentals in various series and combinations, performing one fundamental after another, with or without feet bounces between them.
9. Avoid bouncing too high. Stay low until bounce control and repeated landing in the center of the trampoline can be accomplished. Control is more important than height.
10. While keeping the head erect, focus eyes on the trampoline toward the perimeter. This will help control bounce.
11. Avoid bouncing when tired.
12. Properly secure the trampoline when not in use. Protect it against unauthorized use. Protect it against use by children.
13. Keep objects away which could interfere with the performer. Maintain a clear area around the trampoline.
14. Do not use the trampoline while under the influence of alcohol or drugs.
15. For additional information concerning the trampoline equipment, contact the manufacturer.
16. For information concerning skill training, contact a certified trampoline instructor.
17. Bounce only when the surface of the bed is dry. Wind or air movement must be calm to gentle. The trampoline must not be used in gusty or severe winds.
18. Read all instructions before using the trampoline. Warnings and instructions for the care, maintenance, and use of the trampoline are included to promote safe, enjoyable use of this equipment.

CONDITIONING GUIDELINES

How you begin your exercise program depends on your physical condition. If you have been inactive for several years or are severely overweight, start slowly and increase your workout time gradually. Increase your workout intensity gradually by monitoring your heart rate while you exercise.

Remember to follow these essentials:

- Have your doctor review your training and diet programs.
- Begin your training program slowly with realistic goals that have been set by you and your physician.
- Warm up before you exercise and cool down after you work out.
- Take your pulse periodically during your workout and strive to stay within a range of 60% (lower intensity) to 90% (higher intensity) of your maximum heart rate zone. Start at the lower intensity, and build up to higher intensity as you become more aerobically fit.
- If you feel dizzy or lightheaded you should slow down or stop exercising.

Initially you may only be able to exercise within your target zone for a few minutes; however, your aerobic capacity will improve over the next six to eight weeks. It is important to pace yourself while you exercise so you don't tire too quickly.

To determine if you are working out at the correct intensity, use a heart rate monitor or use the table below. For effective aerobic exercise, your heart rate should be maintained at a level between 60% and 90% of your maximum heart rate. If just starting an exercise program, work out at the low end of your target heart rate zone. As your aerobic capacity improves, gradually increase the intensity of your workout by increasing your heart rate.

Measure your heart rate periodically during your workout by stopping the exercise but continuing to move your legs or walk around. Place two or three fingers on your wrist and take a six second heartbeat count. Multiply the results by ten to find your heart rate. For example, if your six second heartbeat count is 14, your heart rate is 140 beats per minute. A six second count is used because your heart rate will drop rapidly when you stop exercising. Adjust the intensity of your exercise until your heart rate is at the proper level.

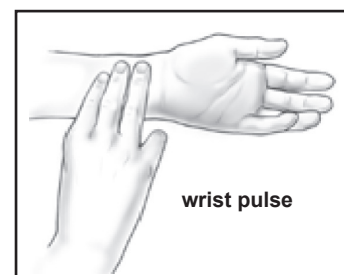

Target Heart Rate Zone Estimated by Age*

Age	Target Heart Rate Zone (55%-90% of Maximum Heart Rate)	Average Maximum Heart Rate 100%
20 years	110-180 beats per minute	200 beats per minute
25 years	107-175 beats per minute	195 beats per minute
30 years	105-171 beats per minute	190 beats per minute
35 years	102-166 beats per minute	185 beats per minute
40 years	99-162 beats per minute	180 beats per minute
45 years	97-157 beats per minute	175 beats per minute
50 years	94-153 beats per minute	170 beats per minute
55 years	91-148 beats per minute	165 beats per minute
60 years	88-144 beats per minute	160 beats per minute
65 years	85-139 beats per minute	155 beats per minute
70 years	83-135 beats per minute	150 beats per minute

* For cardiorespiratory training benefits, the American College of Sports Medicine recommends working out within a heart rate range of 55% to 90% of maximum heart rate. To predict the maximum heart rate, the following formula was used: $220 - \text{Age} = \text{predicted maximum heart rate}$

WORKOUT PROGRAM

Stretching Stretching while your muscles are warm after a proper warm-up and again after your strength or aerobic training session is very important. Muscles stretch more easily at these times because of their elevated temperature, which greatly reduces the risk of injury. Stretches should be held for 15 to 30 seconds. Do not bounce.

Suggested Stretching Exercises (Perform stretches slowly)

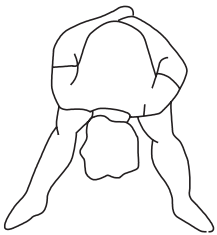

Lower Body Stretch

Place feet shoulder-width apart and lean forward. Keep this position for 30 seconds using the body as a natural weight to stretch the backs of the legs. **DO NOT BOUNCE!** When the pull on the back of the legs lessens, gradually try a lower position.

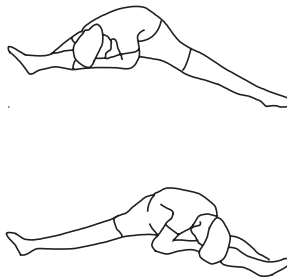

Floor Stretch

While sitting on the floor, open the legs as wide as possible. Stretch the upper body toward the knee on the right leg by using your arms to pull your chest to your thighs. Hold this stretch 10 to 30 seconds. **DO NOT BOUNCE!** Do this stretch 10 times. Repeat the stretch with the left leg.

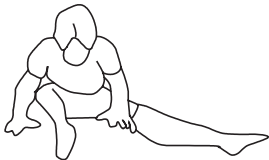

Bent Torso Pulls

While sitting on the floor, have legs apart, one leg straight and one knee bent. Pull the chest down to touch the thigh on the leg that is bent, and twist at the waist. Hold this position at least 10 seconds. Repeat 10 times on each side.

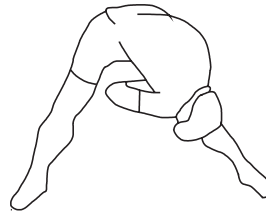
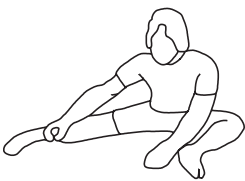

Bent Over Leg Stretch

Stand with feet shoulder-width apart and lean forward as illustrated. Using the arms, **gently** pull the upper body towards the right leg. Let the head hang down. **DO NOT BOUNCE!** Hold the position a minimum of 10 seconds. Repeat pulling the upper body to the left leg. Do this stretch several times slowly.

Remember to always check with your physician before starting any exercise program.

WARM-UP AND COOL-DOWN

Warm-Up The purpose of warming up is to prepare your body for exercise and to minimize injuries. Warm up for two to five minutes before strength-training or aerobic exercising. Perform activities that raise your heart rate and warm the working muscles. Activities may include brisk walking, jogging, jumping jacks, jump rope, and running in place. Below are specific warm-up exercises for the trampoline workout.

Cool-Down The purpose of cooling down is to return the body to its normal, or near-normal, resting state at the end of each exercise session. A proper cool-down slowly lowers your heart rate and allows blood to return to the heart. Your cool-down should include the previously mentioned stretches and the same warm-up exercises listed below.

Warm-Up and Cool-Down Exercises

(Do each movement 10 times)

Contact Bounce

Place your feet shoulder width apart and bend at the knees. Place your hands on your waist. Start bouncing very gently without your feet leaving the mat. This movement is to get you comfortable with being on the mat.



Contact Bounce

Foot Tap

While in the Contact Bounce position, shift your weight towards the right and tap your left foot out to the side. Bring your left foot back to shoulder width. Shift your weight to the left and tap your right foot out to the side. Repeat the movement back and forth.

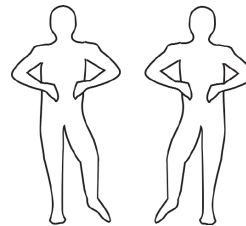

Foot Tap

Hamstring Curls

While bouncing, shift your weight to the right and bring your left foot up to your left buttock. Bring your left foot down and shift your weight to the left and bring your right foot up to your right buttock. Repeat the movement back and forth.

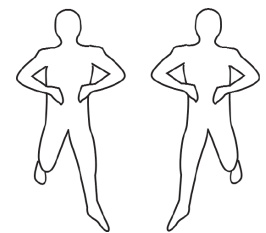

Hamstring Curls

Side To Side

In this movement, place both feet together and bounce from one side of the mat to the other side of the mat. Repeat the movement back and forth.

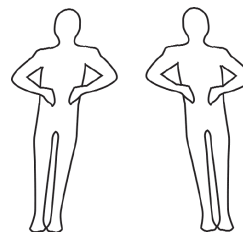

Side To Side

Jog in Place

While standing in the center of the mat, jog in place as you would on the ground.

Jog Bounce

While jogging in place, bounce twice on one leg before switching to the other leg.

BASIC WORKOUT

Basic Workout Exercises

(Do each movement 10 times)

Contact Bounce, Big Bounce

Place your feet shoulder-width apart and bend at the knees. Place your hands on your waist. Start bouncing very gently without your feet leaving the mat. On your second bounce, bounce high enough that your feet leave the mat; only bounce as high as you feel comfortable bouncing. Continue to alternate your bounces back and forth. A variation can be done by raising your forearms as if you are doing biceps curls.

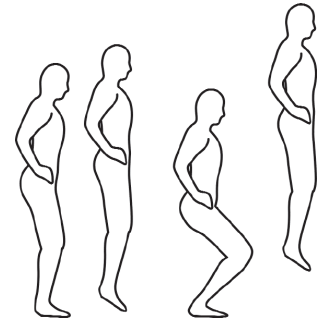

Knee Raises

While in the Contact Bounce position, alternately raise your right and left knees to just above waist height. Repeat the movement back and forth. You can add your own variations to this movement such as raising your arms out to the sides or to the front.

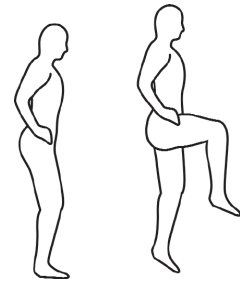

Jumping Jacks

With your feet together in the center of the mat, simultaneously bounce and land with your feet shoulder width apart. At the same time, raise your arms out to the sides and overhead. Then, bounce and land with your feet back together and your arms resting at your sides. Repeat the movement.

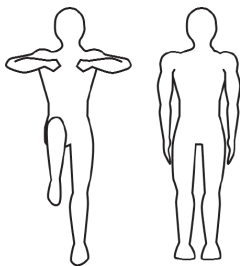
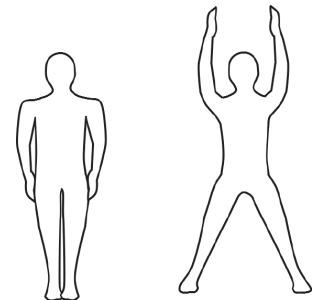

Upright Row

While in the Contact Bounce position, alternately raise your knees to just above waist height. At the same time, perform an upright row with your arms to chin height each time you raise a knee. Repeat the movement.

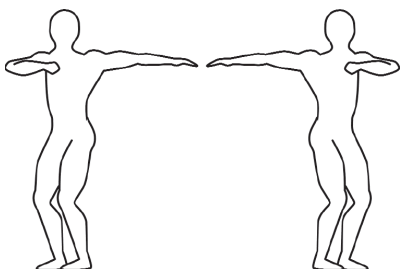

Twist Bounce

With your feet together in the center of the mat bounce and twist your lower body to the right, simultaneously twisting your upper body to the left. Then bounce and twist your lower body to the left, simultaneously twisting your upper body to the right. Repeat the movement.

Basic Workout Program

Trampoline Warm-Up

Do each exercise 10 times

1. Contact Bounce
2. Foot Tap
3. Hamstring Curls
4. Side to Side
5. Contact Bounce
6. Jog in Place
7. Jog Bounce
8. Jog in Place
9. Contact Bounce

Trampoline Cool-Down

Do each exercise 10 times

1. Contact Bounce
2. Jog in Place
3. Jog Bounce
4. Jog in Place
5. Contact Bounce
6. Side to Side
7. Hamstring Curls
8. Foot Tap
9. Contact Bounce

Basic Workout

Do each exercise 10 times

1. Contact Bounce, Big Bounce
(Hands on waist)
2. Contact Bounce, Big Bounce
(Hands, Triceps/biceps movement)
3. Jog in Place
4. Knee Raises (Hands and Shoulder
movement)
5. Jumping Jacks
6. Upright Row
7. Jog in Place
8. Front / Back jumps (Lateral and Forward
shoulder raise)
9. Twist Bounce
10. Knee Raises (Hands on waist)
11. Jog in Place

PRODUCT PARTS DRAWING

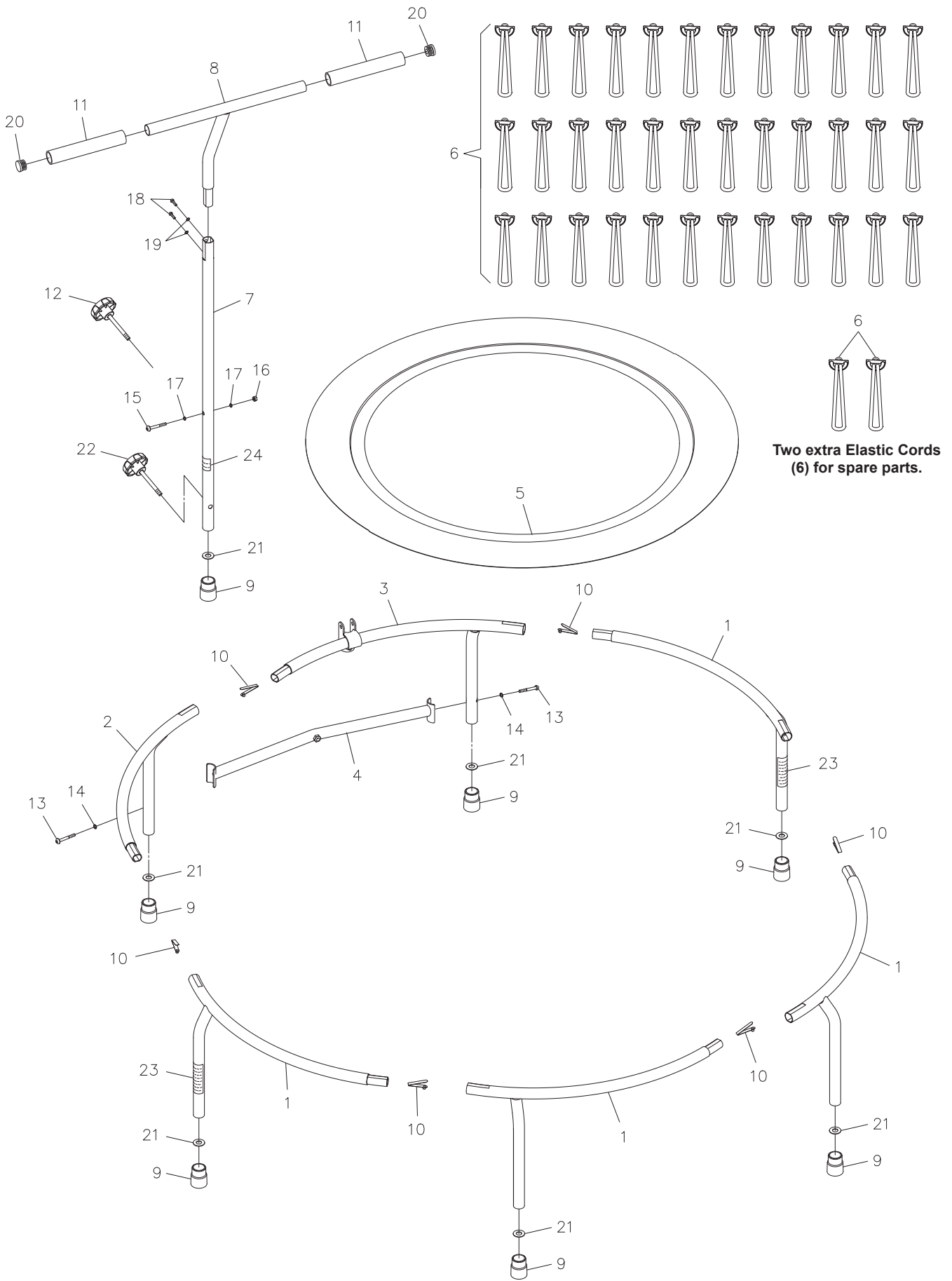

PARTS LIST

PART#	PART NAME	QTY
1	Rail	4
2	Rail w/ Hole	1
3	Rail w/ Bracket	1
4	Cross Bar	1
5	Mat	1
6	Elastic Cord	38
7	Upright	1
8	Handlebar	1
9	Leg Cap	7
10	Button Pin	6
11	Foam Grip	2
12	Locking Knob	1
13	Bolt, Button Head (M8 x 1.25 x 35mm)	2
14	Arc Washer (M8)	2
15	Bolt, Button Head (M8 x 1.25 x 45mm)	1
16	Nylock Nut (M8 x 1.25)	1
17	Washer (M8)	2
18	Bolt, Button Head (M6 x 1 x 15mm)	2
19	Arc Washer (M6)	2
20	Round Plug (25mm)	2
21	Cap Washer	7
22	Long Locking Knob	1
23	Warning Label	2
24	Serial Decal	1
25	Use Instructions Sign (Not Shown)	1
26	Cord Tool	1
27	Allen Wrench (6mm)	1
28	Allen Wrench (4mm)	1
29	Wrench	1
30	Manual	1

LIMITED WARRANTY

MODEL 35-1820

WARRANTY

Stamina Products, Inc. ("Stamina") warrants to the original purchaser that this product will be free from defects in materials and workmanship that arise under normal use, service, proper assembly and proper operation in accordance with product warnings/instructions for a period of 90 days on the parts and one year on the frame from the date of the original purchase from an authorized retailer. **THIS WARRANTY SHALL NOT APPLY TO ANY PRODUCT WHICH HAS BEEN SUBJECT TO COMMERCIAL USE, ABUSE, MISUSE, ALTERATION OF ANY KIND OR TO ANY DEFECT OR CHANGE CAUSED BY IMPROPER ASSEMBLY, REPAIR, REPLACEMENT, SUBSTITUTION OR USE WITH PARTS NOT PROVIDED BY STAMINA.** Commercial use includes use of product in athletic clubs, health clubs, spas, gyms, and all other public or semipublic facilities whether or not the product's use is in furtherance of a profit making enterprise, and all other use which is not for personal purposes.

To implement this limited warranty, send a written notice stating your name, date, and place of purchase and a brief description of the defect along with your receipt to Stamina Products, Inc. 2040 N Alliance Ave, Springfield, Missouri, USA, MO 65803, or email us at customer.care@staminaproducts.com, or call us at 1-800-375-7520. If the defect is covered under this limited warranty, you will be requested to return the product or part to us for free repair or replacement at our option.

NO ACTION FOR BREACH OF THIS LIMITED WARRANTY MAY BE COMMENCED MORE THAN ONE (1) YEAR AFTER THE DATE THE ALLEGED BREACH WAS OR SHOULD HAVE BEEN DISCOVERED. NO ACTION FOR BREACH OF ANY IMPLIED WARRANTY (INCLUDING MERCHANTABILITY AND FITNESS FOR A PARTICULAR PURPOSE) MAY BE COMMENCED MORE THAN ONE (1) YEAR AFTER DELIVERY OF THE PRODUCT TO THE PURCHASER. These warranties are not transferable. **IF ANY PART OF THE PRODUCT IS NOT IN COMPLIANCE WITH THIS LIMITED WARRANTY OR ANY IMPLIED WARRANTY, THE REMEDY OF REPAIR OR REPLACEMENT IS THE EXCLUSIVE REMEDY.** If any claim is made under this limited warranty or any implied warranty, Stamina reserves the right to require the product to be returned for inspection, at the purchaser's expense, to Stamina's premises in Springfield, Missouri. Return of the enclosed warranty registration card is not required for warranty coverage, but is merely a way of establishing the date and place of purchase.

Stamina **SHALL NOT BE LIABLE FOR THE LOSS OF USE OF ANY PRODUCT, LOSS OF TIME, INCONVENIENCE, COMMERCIAL LOSS OR ANY OTHER INDIRECT, CONSEQUENTIAL, SPECIAL OR INCIDENTAL DAMAGES DUE TO BREACH OF THE ABOVE WARRANTY OR ANY IMPLIED WARRANTY.**

THIS LIMITED WARRANTY IS THE ONLY EXPRESS WARRANTY. NO ORAL OR WRITTEN INFORMATION GIVEN BY STAMINA, ITS AGENTS OR EMPLOYEES, SHALL CREATE A WARRANTY OR IN ANY WAY INCREASE THE SCOPE OF THIS WARRANTY. This warranty gives you specific legal rights, and you may also have other legal rights which vary from state to state. **ANY OTHER RIGHT WHICH YOU MAY HAVE, INCLUDING ANY IMPLIED WARRANTY OF MERCHANTABILITY OR FITNESS FOR A PARTICULAR PURPOSE, IS LIMITED IN DURATION TO THE DURATION OF THIS WARRANTY.**

The laws in some states affect the disclaimer or limitation of implied warranties and consequential and incidental damages. If any such law is found applicable, the foregoing disclaimers and limitations of and on implied warranties and consequential and incidental damages shall be deemed to be modified to the extent necessary to comply with applicable law.

TO CONTACT CUSTOMER CARE

For your convenience, Stamina's customer care representatives can be reached by email at customer.care@staminaproducts.com or by phone at 1-800-375-7520 (in the U.S.). Our customer care representatives are available Monday through Thursday from 7:30 a.m. until 5:00 p.m., and Friday 8:00 a.m. until 3 p.m. Central Time.



**ONLINE
CUSTOMER CARE**
customer.care@staminaproducts.com
www.staminaproducts.com



**TELEPHONE
CUSTOMER CARE**
Tel: 1 (800) 375-7520



**FAX
CUSTOMER CARE**
Fax: (417) 889-8064



MAIL
STAMINA PRODUCTS, INC.
ATTN: Customer Care
2040 N Alliance Ave, Springfield, MO 65803

Would you like to receive email information or special offers from Stamina Products? Register at contact.staminaproducts.com

TO REGISTER YOUR PRODUCT

To enact your warranty, please register your product by going to register.staminaproducts.com. Please have your product model number (printed on the cover of this owner's manual) and the serial number (printed on the black and white sticker on your product) ready.

If you don't have internet access, you can call customer care at 1-800-375-7520, or fill out and mail the product registration form below to Stamina Products, Inc.; 2040 N Alliance Ave, Springfield, MO 65803.

PRODUCT REGISTRATION FORM		Stamina Products, Inc. 2040 N Alliance Ave, Springfield, MO 65803	
Model Number:		Serial Number:	
Product Name:			
Place Purchased:			
Date of Purchase:		Purchase Price:	
First Name:		Last Name:	
City:	State:	Phone #: ()	Zip Code:
Email Address:		Phone #: ()	
Would you like to receive email information or special offers from Stamina Products?* <input type="checkbox"/> Yes <input type="checkbox"/> No *If yes, be sure your email address is included above.			



Detach and Mail or Fax the Form Above



TO ORDER PARTS

If there are missing or damaged parts, you can go to parts.staminaproducts.com and order those parts. If you have questions, please contact customer care. Do not return the product. To order parts by mail, fill out the sheet below and fax it to 417-889-8064. The part will be mailed to your address.



Detach and Mail or Fax the Form Below



PARTS ORDER FORM		Stamina Products, Inc. 2040 N Alliance Ave, Springfield, MO 65803	
Mr./Ms:			
Address:		Apt. #:	
City:	State:	Zip Code:	
IMPORTANT : We require your phone number to process the order!			
Phone #: ()		Work Phone #: ()	
Date of Purchase:			
Model #:			
Purchased From:			
IMPORTANT: Before filling out the portion below, make sure you have the correct information. Refer to the parts list to make sure you're ordering the right parts!			
PART #	DESCRIPTION	QUANTITY	
EXAMPLE: 1	Rear Unit Assembly	1	