

Owner's Manual

All-Terrain Vehicle Model Number
Coolster Mountopz ATV-3050C



For Maintenance and Safety: READ THIS MANUAL CAREFULLY. IT CONTAINS IMPORTANT SAFETY AND OPERATION INFORMATION.

YOUNG RIDERS ARE REQUIRED TO BE SUPERVISED BY AN ADULT AT ALL TIMES.

OPERATION IS PROHIBITED FOR ANYONE UNDER AGE (6).



WARNING - Operating, servicing and maintaining a passenger vehicle or off-road vehicle can expose you to chemicals including engine exhaust, carbon monoxide, phthalates, and lead, which are known to the State of California to cause cancer and birth defects or other reproductive harm. To minimize exposure, avoid breathing exhaust, do not idle the engine except as necessary, service your vehicle in a well-ventilated area, and wear gloves or wash your hands frequently when servicing your vehicle. For more information go to www.P65Warnings.ca.gov/passenger-vehicle

 Read this manual carefully before operating this vehicle. This manual should stay with this vehicle if it is sold.

Introduction – Safety- Training

Thank you for choosing Coolster vehicles, courtesy of MAXTRADE LLC.

This manual has been prepared to help familiarize you with the proper operation and maintenance procedures of your Coolster vehicle. It is HIGHLY recommended that you read all the information within this manual before operating this vehicle. Thoroughly reading this manual will greatly minimize the risk of injury and damage.

Free Safety Training is available to anyone who buys a new ATV. It is STRONGLY recommended that all operators of this vehicle enroll in a rider training program, through their dealer or a qualified instructor, to gain awareness of the mental and physical requirements necessary for safe vehicle operation. If you have any questions regarding safety or training enrollment, please call MAXTRADE LLC at [1-626-228-0251](tel:1-626-228-0251).

For training information and courses, please call ASI (ATV Safety Institute) at [1-800-887-2887](tel:1-800-887-2887).

We also have an after-hours safety hotline at [1-800-307-3429](tel:1-800-307-3429).

Maxtrade certifies that this ATV complies with the ANSI/SVIA 1-2017 Standard and all genuine Coolster ATV's are labeled with this certification, which can be found on the front right area of the frame when the operator is seated on the vehicle.

Thank you once again for choosing Coolster.

We wish you many years of safe and pleasant riding.

Important Safety Message to Parents & Children

This vehicle is intended for riders (6) years of age or older. Never allow a child under the age of (6) to operate this vehicle.

This ATV is not a toy. Before you let your child ride this ATV be sure they have completed an ATV Training Course. For information regarding a Free ATV Training Course call 1-800-887-2887.

Parents and children should understand the instructions and warnings in this Owner's Manual. Parents must be sure the child understands all safe use information and is willing and able to follow them.

Failure to operate this vehicle properly can result in a collision, loss of control, accident or rollover, which may result in serious injury or death. Heed all safety warnings outlined in this owner's manual.

Never allow a child under the age of 16 to operate an ATV without adult supervision. Children differ in skills, physical abilities and judgment. Supervising adults should exercise discretion as to which riding activities are suitable and safe for the child. Some children may not be able to operate an ATV safely. Parents should supervise their child's use of the ATV at all times. Parents should permit continued use only if they determine that the child has the ability to operate the ATV safely.

Read and understand all of the labels on your ATV. These labels contain important information for safe and proper operation.

Never remove any labels from your ATV. If a label becomes difficult to read or comes off, request a replacement label from your local dealer.

TABLE OF CONTENTS

Introduction – Safety- Training.....	3
Important Safety Message to Parents & Children	4
Vehicle Identification.....	6
Safety Symbols and Signal Words	7
Safety Warnings, Safety Labels and Locations	8
Vehicle Configuration and Parts	14
Vehicle Features and Controls	15
Safe Riding Guidelines	17
Pre-Ride Inspection Checklist	19
Operation.....	21
Parking and Storage.....	25
Regular Maintenance and Minor Repairs	26
Fuse Replacement	38
Common Problems.....	39-41
Cleaning, Storage, and Transport.....	42-44
Safe Operation	45-55
Specifications	56
Emissions Warranty Parts List.....	57
Electrical Diagram	58

Vehicle Identification

Your vehicle is provided with a unique Vehicle Identification Number (VIN) and can be located as shown below.

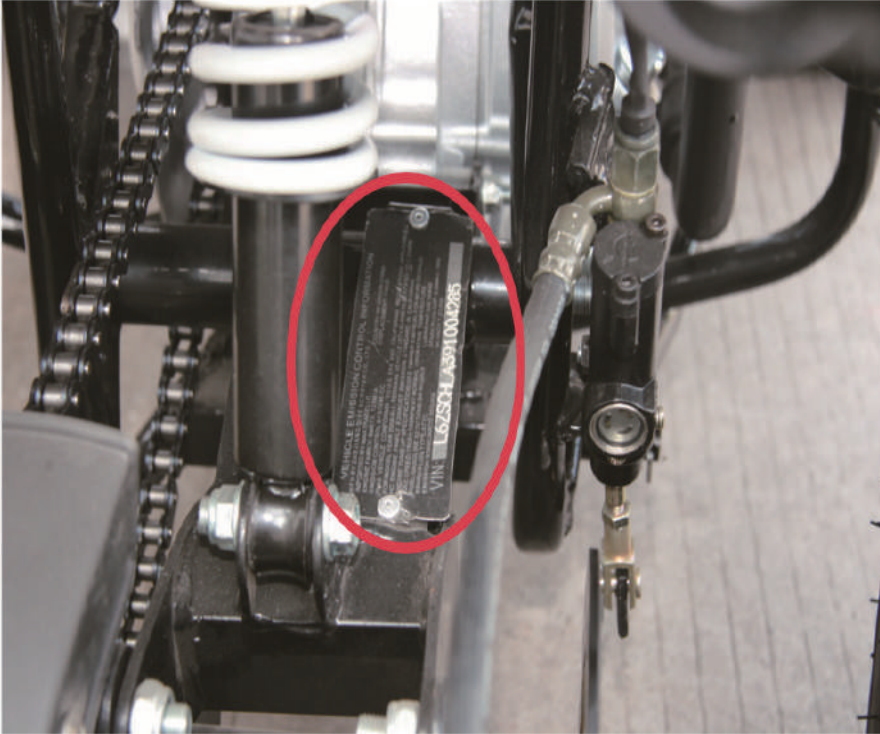





Your vehicle has a permanent label for the Engine Model and Serial Number and can be located as shown.



Safety Symbols and Signal Words

The following signal words and symbols appear throughout this manual and on your vehicle. Your safety is involved when these words and symbols are used. Become familiar with their meanings before reading the manual.

	This is the safety alert symbol. It is used to alert you to potential personal injury hazards. Obey all safety messages that follow this symbol to avoid possible injury or death.
	Warning indicates a hazardous situation which, if not avoided, could result in death or serious injury.
	Danger indicates a hazardous situation that, if not avoided, will result in death or serious injury.
	Caution, used with the safety alert symbol, indicates a hazardous situation that, if not avoided, could result in minor or moderate injury.
	NOTICE indicates information considered important, but not hazard related.

FAILURE TO FOLLOW THE WARNINGS CONTAINED IN THIS MANUAL CAN RESULT IN SERIOUS INJURY OR DEATH.

Safety Warnings, Safety Labels and Locations



Failure to operate this vehicle properly can result in a collision, loss of control, accident or rollover, which may result in serious injury or death. Heed all safety warnings outlined in this section of the owner's manual.

Read and understand all of the labels on your ATV. These labels contain important information for safe and proper operation.

Never remove any labels from your ATV. If a label becomes difficult to read or comes off, request a replacement label from your local dealer.

Tire Pressure Warning Label, Overloading Warning Label or Combined Tire Pressure and Overloading Warning Label

Located on the Left Rear Fender, either Two (2) Separate Warning Labels or One (1) Combined Label as show Below:

Tire Pressure Warning Label

⚠ WARNING

Improper tire pressure can cause loss of control.
Loss of control can result in severe injury or death.

- Cold tire pressure:
Front: 10 psi (68.9 kPa)
Rear : 10 psi (68.9 kPa)

Overloading Warning Label

⚠ WARNING

Overloading can cause loss of control.
Loss of control can result in severe injury or death.

- Maximum weight capacity: 143 lbs. (65 kg)

Combined Tire Pressure and Overloading Warning Label

 **WARNING**

Improper tire pressure or overloading can cause loss of control. Loss of control can result in severe injury or death.

- Cold tire pressure:
 - Front: 10 psi (68.9 kPa)
 - Rear : 10 psi (68.9 kPa)
- Maximum Weight Capacity: 143 lbs. (65 kg)

General Warning Label – Located on the left front fender

⚠ WARNING

Improper ATV use can result in SEVERE INJURY or DEATH

			
ALWAYS USE AN APPROVED HELMET AND PROTECTIVE GEAR	NEVER USE ON PUBLIC ROADS	NEVER CARRY PASSENGERS	NEVER USE WITH DRUGS OR ALCOHOL

NEVER operate:

- without proper training or instruction
- at speeds too fast for your skills or the conditions
- on public roads - a collision can occur with another vehicle
- with a passenger - passengers affect balance and steering and increase risk of losing control

ALWAYS:

- use proper riding techniques to avoid vehicle overturns on hills and rough terrain and in turns
- avoid paved surfaces - pavement may seriously affect handling and control

**LOCATE AND READ OWNER'S MANUAL.
FOLLOW ALL INSTRUCTIONS AND WARNINGS.**

Age Recommendation Warning Label – Located on the front right area of the frame when the operator is seated on the vehicle

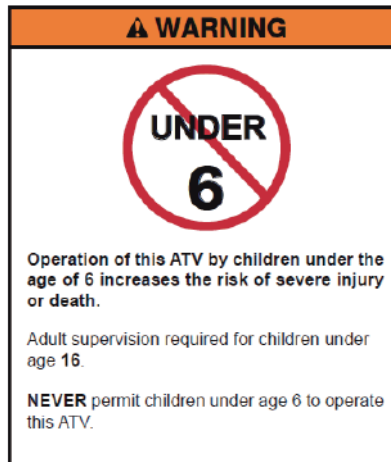

Passenger Warning Label - This the label shall be affixed to the left rear fender so as to be easily read by a potential passenger.

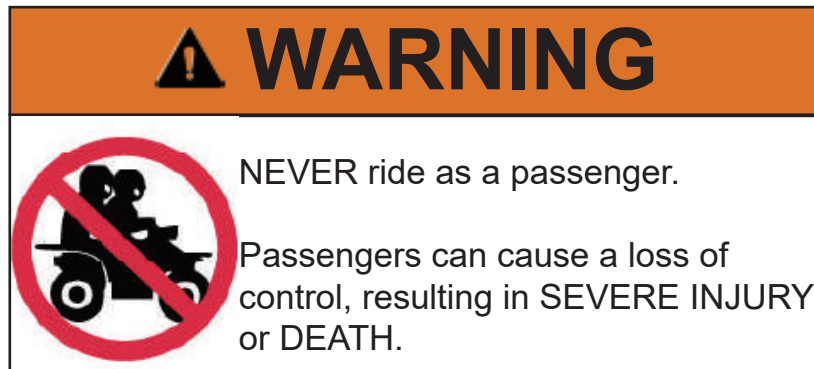

Vehicle Configuration and Parts



- (1) Rear Rack
- (2) Muffler
- (3) Seat
- (4) Foot Brake
- (5) Engine
- (6) Key Switch
- (7) Front Guard





- (8) Handle Bar
- (9) Fuel Box
- (10) Front Wheel
- (11) Rear Wheel
- (12) Rear Light
- (13) Rear Suspension





- (14) Plastic (Body)
- (15) Front Brake
- (16) Accelerator

Vehicle Features and Controls



1. IGNITION SWITCH

LOCATION	FUNCTION	KEY STATE
	All Circuits are disconnected	Pull out
	Circuits connected engine started	Do not pull out

2. MULTIFUNCTION SWITCH

PROXIMITY SWITCH	LOCATION	FUNCTION
		
STARTER SWITCH		When state switch is pressed, engine rotation begins
OFF SWITCH		When off switch is pressed, engine rotation stops

3. ACCELERATOR CONTROLLER

		When accelerator is pressed, vehicle will start moving
		Avoid adjusting the speed limiter

This ATV comes equipped with a remote key which consists of two buttons:

1. KILL SWITCH
2. UNLOCK BUTTON



The engine can be stopped using the remote from a short distance. The adult who trains the operator should always keep the kill switch on hand, until the vehicle operator develops the skills needed to operate the vehicle safely. The remote key is very easy to operate. The purple kill switch is to stop the engine in the event of a hazardous or unsafe situation. In order to start the engine again, simply click the unlock button.

The remote key works best within 65 feet (20 meters) of the vehicle.

Safe Riding Guidelines

An ATV handles differently than other vehicles. An ATV is not a toy, driving them may pose a serious risk of injury to the riders or others if the rider is not properly informed. If the driver does not take precautions, dangerous accidents such as collisions or rollovers can occur, even during routine maneuvers such as turning or driving on hills or obstacles.

Please read the following safe riding guidelines thoroughly, as doing so can drastically reduce the risk of serious injury or death:

1. Read this manual and all labels carefully and follow the operating procedures as described.
2. Beginners are strongly recommended to complete a proper training course before the operation of this vehicle. It is not suggested for riders to operate without proper guidance.
3. Individuals below (6) years old CAN NOT drive this vehicle.
4. This vehicle is designed to carry the driver only. Passengers are not allowed.
5. It is unsafe and/or illegal to drive this vehicle on paved roads, including sidewalks, public streets, highway/freeways, parking lots, and even paved roads made of stone.
6. The driver must wear suitable protective equipment, such as a DOT, Snell, or ECE 22.05 certified helmet, eye protection (goggles or face shields), gloves, boots, long-sleeved shirts, and long sleeve pants.
7. Never consume alcohol or drugs (prescription or over the counter medication included) before or while operating this vehicle.
8. Never operate at unsafe speeds. Always travel at a speed that is proper for the terrain, visibility, and operating conditions, as well as rider experience.
9. Never attempt any tricks or stunts.
10. Always inspect the vehicle before use to make sure that it is in safe operating condition. Always follow the maintenance and inspection procedures described in this manual.
11. Always drive slowly and pay more attention when driving on unfamiliar terrain. Be alert to sudden changes in terrain.
12. Never operate on excessively rough, slippery, or loose terrain.
13. When turning, always follow proper procedures as described in this manual. Before attempting turns at faster speeds, be sure to be comfortable turning at lower speeds. Do not turn at excessive speeds.
14. Never operate on hills too steep for the vehicle or your abilities. Practice on smaller hills first before attempting larger hills.
15. Always follow proper procedures for climbing and braking on hills according to the instructions in this manual. Carefully observe the terrain before climbing any hills. Never climb hills with slippery or soft surfaces. Never open the throttle suddenly or make abrupt gear changes. Do not go at high speeds when climbing the peak.
16. Always follow proper procedures for descending and braking on hills according to the instructions in this manual. Carefully observe terrain before going downhill, and keep center of gravity rearwards. Do not go at high speeds downhill and avoid turning while descending (failure to do so may cause ATV to lean sharply to one side). Go straight down the hill where possible.
17. Always follow proper procedures for crossing the side of hills according to the instructions in this manual. Avoid hills with slippery or loose surfaces. Never attempt to turn the vehicle around on any hill, and avoid crossing steep hillsides entirely if possible.
18. Always follow proper procedures from this manual if you stall or roll backwards when climbing a hill. When climbing, if you stall or reverse, follow the special procedures for braking as described in this manual. To avoid stalling, maintain a steady speed when climbing a hill.
19. When driving in unfamiliar areas, pay attention to obstacles. Do not try to climb over large obstacles, such as large rocks or fallen trees. Always follow proper procedures when operating

overobstacles as described in this manual.

20. Be careful of skidding or sliding. Learn to control braking to prevent sliding or skidding on flat roads at low speeds. On slippery surfaces, such as ice, go slowly and be very cautious in order to minimize the chances of skidding or sliding out of control.
21. Avoid operating the vehicle through deep or fast moving water. Avoid water which exceeds therecommended maximum depth, as this wets and jeopardizes the functions of the brakes. If going through low water, make sure to maintain a slow and steady speed and do not make any sudden turns, stops, or throttle changes. After exiting water, test brakes for functionality. If necessary, apply brakes lightly several times to let friction dry the brake pads.
22. When reversing, please ensure that there are no obstacles or people behind the ATV. When reversing, go slowly and avoid making sharp turns.
23. Always use the specified type and size of the tires as well as tire pressure indicated in this manual.
24. Never modify the vehicle through improper installation or use of accessories.
25. Do not overload the load capacity.
26. Do not touch the vent pipe as this can cause severe burns.

Pre-Ride Inspection Checklist

Prior to the use of this vehicle, please check that the following components and features are functioning properly and are not damaged:

Ensure that:

1. The fuel tank has enough fuel before riding.
2. Check the oil level.
3. Inspect the entire vehicle for any loose components and/or loose nuts/bolts. Always check the tightness of the chassis fittings and fasteners before riding.
4. Check for smooth operation and lubricate if necessary. Make sure there is no looseness of any components.
5. Check for tire pressure, potential wear, unevenness and any loose nuts, bolts or cotter pins.
6. Check to see if the chain drive is damaged or needs adjusting. Adjust if necessary.
7. Check the throttle to ensure the engine operates correctly. It must be smooth and spring back to the idle position when released.
8. Check all brakes for functionality, and to see if any adjustments are needed.
9. Pump the brake pedal to make sure the mechanisms are working.
10. Make sure there are no leaking fluids.
11. Check to ensure that the battery has a proper charge.

NOTICE

Fuel Check: Do not fill the tank with more than the tank capacity of fuel. Otherwise, the fuel can overflow and can cause damage to the vehicle. If fuel spills, keep it from touching the engine and clean up as necessary.

Recommended fuel: 90 octane gasoline

Fuel tank capacity total: 2.06 L (0.54 gallons)

Oil Levels

Measuring the Oil: Allow the engine to run and warm up for a couple of minutes. Turn off the engine and wait for a few minutes. Remove the dipstick, wipe it with a clean rag, and reinsert it in the receptacle. Remove the dipstick again and check oil level. The oil should be located between the highest and lowest marks along the oil dip stick. If the oil level is too low, add more oil to ensure oil levels are appropriate.

Maximum oil level (1)

Minimum oil level (2)



Recommended Oil

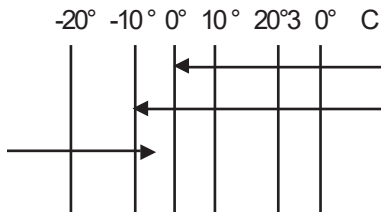

SAE 20W40 SF Engine Oil
SAE 10W30 SF Engine Oil
SAE 5W30 SF Engine Oil

Operation

Tires

1. Tire pressure

Before the vehicle is in operation, always check and adjust tire pressure to the specification in the table below.

2. Tire Inspection

Before the vehicle is in operation, check the tires.

If there is excessive tire wear, replace the tires.



Use of the worn-out tires is dangerous

	Tire Size	Pressure
Front Tire	145/70-6	10 PSI
Rear Tire	145/70-6	10 PSI

Cold Start and Engine Preheating

When doing a cold start, the choke should be closed to limit the amount of air entering the engine. This will help with warming up the engine.

NOTICE

This vehicle requires the front brake handle to be depressed in order to start the engine. Squeeze the engine brake handle to start.

1. Turn ignition switch to the “on” position.
2. Turn the fuel valve to “on” position.
3. Step on the rear brake pedal and hold (to prevent vehicle from launching forward).
4. Make sure the upward throttle is closed.
5. Squeeze the front hand brake
6. Press the start switch until the engine engages.
7. Release the throttle and allow engine to idle.
8. Lightly tap the accelerator to rev engine to sustain combustion if needed.

Note: If the engine does not start, release the starting switch, wait a few seconds, and then try again. Continue attempting to start with at least 30 seconds in between attempts in order to protect the battery. The starter should not be forced for more than 5 seconds when attempting ignition.

Note: In order to maintain maximum engine life, ensure the engine is preheated before riding. Allow engine to run for several minutes before riding. Cold-engine acceleration is not recommended.

Acceleration

Speed limiter

For beginning riders, riders less experienced with this model, or whenever limited speed is desirable, the throttle lever housing is equipped with a vehicle speed limiter. The speed limiter keeps the throttle from fully opening, even when the throttle lever is pushed to the maximum. Turning in the adjusting screw limits the maximum engine power available and decreases the maximum speed of the ATV. Turning in the adjusting screw decreases top speed, and turning it out increases top speed.

As the throttle is pushed forward the engine will generate more power and the speed of the ATV will increase. The throttle has been set by the manufacturer at the lowest speed, and as the rider becomes more familiar with the ATV and their skills improve, the speed limiting screw can be adjusted to match the abilities of the rider.

When the rider releases the throttle the engine will gradually decrease the speed of the ATV.

Braking

This ATV is equipped with both foot and hand brakes. To slow the vehicle to a stop, gradually apply pressure to both the front and rear brakes simultaneously for a controlled stop.

Avoid sudden depression of the brakes and never apply only the front brakes.

Parking and Storage

Please use parking brake when you are parking the ATV (pictured)

1. Hold down front brake lever and make sure the vehicle is at a full stop
2. Press parking brake button to lock the front axle parking brake
3. Pull parking brake lever counter-clockwise towards the end of the handle bar to lock the rear axle parking brake



Make sure the vehicle is stored in a safe, well-ventilated place; locked, with keys removed.

Make sure the fuel valve is set to the “off” position.

If possible, conduct a parking inspection, which includes checking the lighting, fuel quantity, and lubricant levels.

NOTICE

When conducting a parking inspection, be careful to not touch the very hot exhaust muffler and ensure children are at a safe distance away.

Do not park the vehicle near vulnerable areas.

Regular Maintenance and Minor Repairs

NOTICE

If you are not familiar with this vehicle's maintenance services, consult your local Coolster repair shop.

Regular Maintenance / Lubrication Schedule

ITEM	NOTES	RUN- NING 150 KM OR FIRST MONTH	INITIAL 1000 KM OR THREE MONTH	EVERY 2000 KM OR THREE MONTH
SPARK PLUG	CLEAN OR REPLACE IF NECESSARY		X	X
AIR FILTER	CLEAN OR REPLACE IF NECESSARY		X	X
CARBURETOR	CHECK THE IDLING. IF NECESSARY, ADJUST	X	X	X
FUEL PIPE*	CHECK FOR CRACKS OR DAMAGE. IF NECESSARY, REPLACE	X	X	X
OIL FILTER*	CHECK FOR CRACKS OR DAMAGE. IF NECESSARY, REPLACE	X	X	X
ENGINE OIL	REPLACE OIL IF IT HAS HIT THE NECESSARY CHECKMARKS	300KM AND 1000KM, FIRST REPLACE- MENT	X	X
ENGINE OIL FILTER*	CLEAN. IF NECESSARY, ADJUST OR REPLACE	X	X	X

ITEM	NOTES	RUNNING 150 KM OR FIRST MONTH	INITIAL 1000 KM OR THREE MONTH	EVERY 2000 KM OR THREE MONTH
TIRE/ WHEEL*	CHECK TIRE PRES- SURE/BALANCE/ WEAR STATE. IF NECESSARY, REPAIR OR REPLACE		X	X
FRONT HUB BEARING* **	CHECK BREAINGS FOR LOOSENESS/ DAMAGE. IF DAMAGED, REPLACE	X	X	X
REAR AXEL BEARING* **	CHECK BREAINGS FOR LOOSENESS/ DAMAGE. IF DAM- AGED, REPLACE	X	X	X
CHAIN DRIVE	CHECK CHAIN TEN- SION. IF NECESSARY, ADJUST, REPLACE OR CLEAN AND LUBRICATE	X	X	X
PARTS AND FASTENERS	CHECK ALL PARTS AND FASTENERS. CORRECT IF NECESSARY	X	X	X
BATTERY*	CHECK CHARGE. IF NECESSARY, REPLACE	X	X	X

*: We suggest that these items be repaired at Coolster certified maintenance stations.

** : Medium weight wheel bearing grease.

Parts and Fasteners

Prior to the use of the vehicle, ensure that all parts and fasteners are secured tightly. We suggest you do this during regular inspections.



If the self-locking nut is destroyed, replace immediately.

TIGHTENING TORQUE CORRESPONDENCE TABLE

SCREW SIZE	TIGHTENING TORQUE N-M	STANDARD TORQUE N-M	SCREW SIZE	TIGHTENING TORQUE N-M	STANDARD TORQUE N-M
M5	4.5-6.0	5	M10	37-79	60
M6	8-12	9	M12	73-115	99
M8	16-26	23	M14	146-205	180

Measuring the Oil

Allow the engine to run and warm up for a couple of minutes. Turn off the engine and wait for a few minutes. Remove the dipstick, wipe it with a clean rag, and reinsert it in the receptacle. Remove the dipstick again and check oil level. The oil should be located between the highest and lowest marks along the oil dip stick. If the oil level is too low, add more oil to ensure oil levels are appropriate.

Oil and Oil Filter Replacement

- A. Release oil bolts to allow oil to drain. When draining the oil, moderately shake the ATV to dislodge any impurities inside of the engine.
- B. Re-install released oil bolts, and then fill with engine oil.
- C. Tighten oil bolts.
- D. Start engine and allow it to run for a few minutes to preheat. During preheating, check for any oil leaks. If there appears to be an oil leak, immediately stop engine and check vehicle.

Replace oil a second time about a month or so after the first oil change to clean oil filters.



Do not add any chemical additives to the oil.

NOTICE

When replacing oil or checking oil pressure, please do so in accordance to the following method:

- A. Remove the cylinder cover by the oil release bolts.
- B. Start motor and allow it to idle until the oil outflows from the drain hole. After a minute, if oil does flow out or you see any other unusual occurrence, stop the engine and bring the ATV to the nearest Coolster dealer or maintenance shop for repair.
- C. After the test is completed, tighten the released oil bolts.

Carburetor Adjustment

The carburetor is a key part of the vehicle engine and requires proper adjustments. Most adjustments should be handled by those with expertise or experience with Coolster repairs.

Idle Adjustment

SCREW IDLING

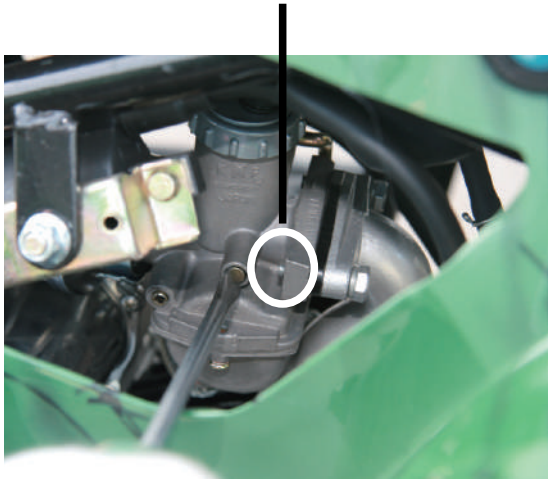

RELEASE OIL POINT

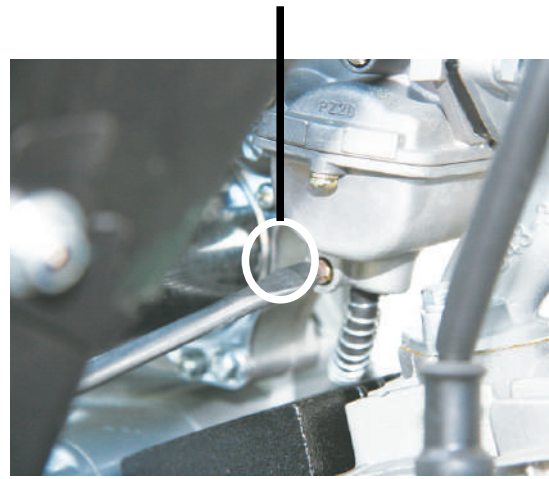

The idle screw on the carburetor can affect the engine speed. The standard idle configuration is shown below:

Standard Idle: 1500 ± 100 to/min

Crankcase Ventilation System

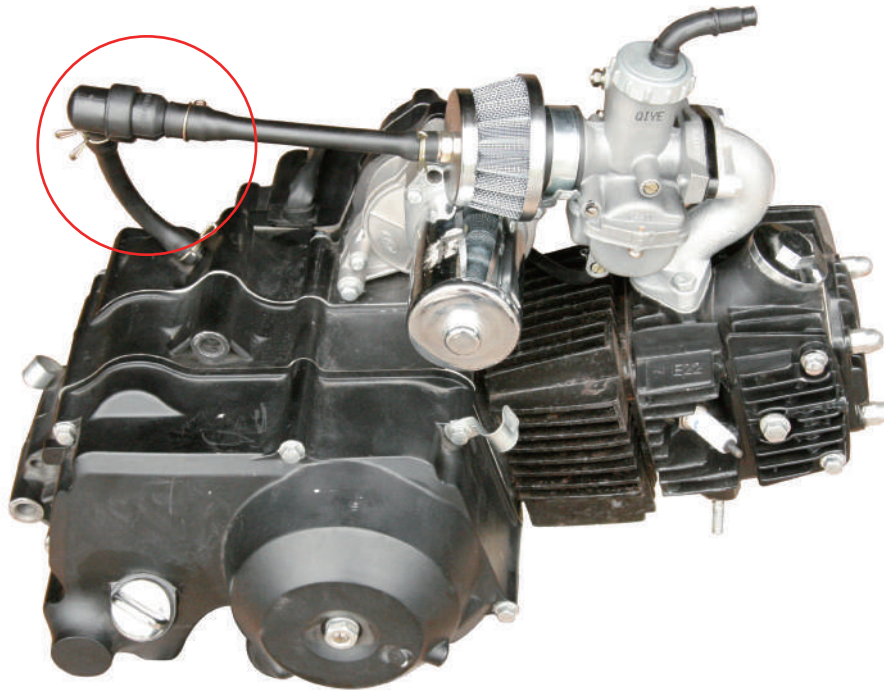

This part operates 150 hours at a time. Please carry out regular maintenance to ensure the system can function properly.

1. Take out the oil separator, use kerosene to wash.
2. Be sure not to damage the filter when taking it out.
3. The part can be cleaned and used repeatedly as long as it is not damaged.
4. Dispose of the waste according to all appropriate local, state, and federal regulations.

Air Filter & Throttle Cable Adjustment

Regular checks should be performed on air filters.
Clean or replace if needed.

Throttle Cable Adjustment

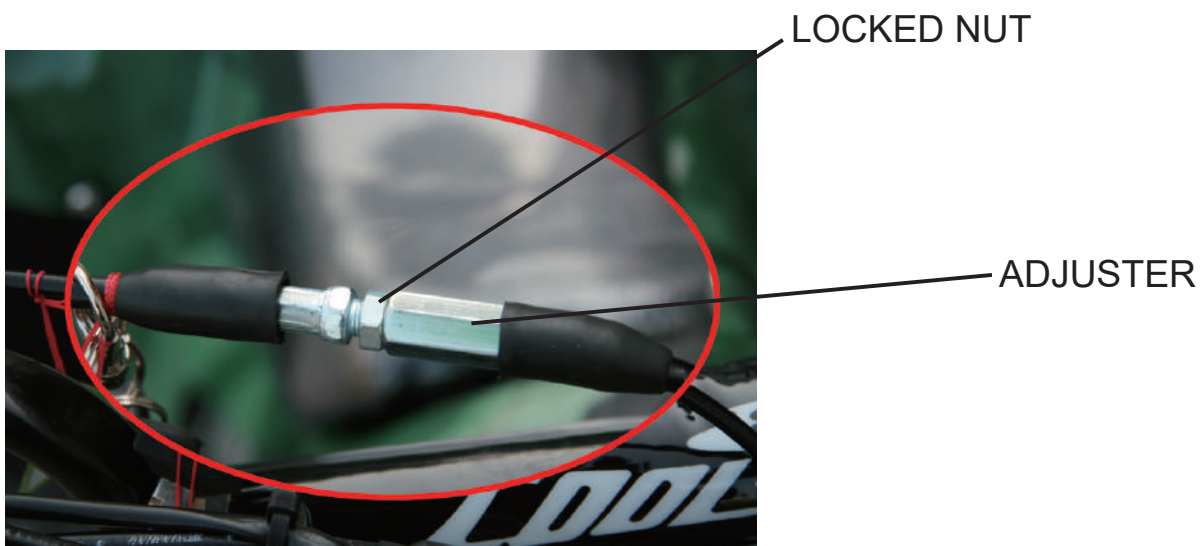

Note: When adjusting the throttle cable, we must also adjust engine idling.
Connect the tachnometer, and adjust the throttle to limit the idle speed. Adjust the screw and idle speed to an ideal value

1. Loosen lock nut.
2. Adjust until obtaining the proper cable tension.
3. Tighten the lock nut.

Spark Plug Inspection

Model: D7TC

Clearance: 0.6~0.7 mm

Torque: 12.5 N - M



0.6~0.7mm

1. Remove the spark plug and inspect it each time you change the oil. The electrodes should be kept clean and free of carbon. The presence of carbon or excess oil will greatly reduce engine performance. If possible, check the spark plug gap using a wire feeler gauge. This specification is 0.6 - 0.7 mm.
2. Before installing the spark plug, coat the threads lightly with graphite grease, if possible, to ensure easy removal next time the spark plug needs inspection.
3. It is advisable to replace the spark plug at least once a year to ensure easy starting and good engine performance.

Note: If you have not installed it with a spark plug torque wrench, the correct torque estimation method is hand tight, then an additional 1/4 to 1/2 turn.

Brake Adjustment

The front wheel brake handle stall leeway should be:

10 - 15 mm (13/32" - 19/32")

1. Loosen lock nut
2. Rotate length of the cable and fasten the screw to the appropriate area.
3. Tighten the lock nut.
4. If the brake handle is not operating properly, please visit your local Coolster dealer or repair shop.

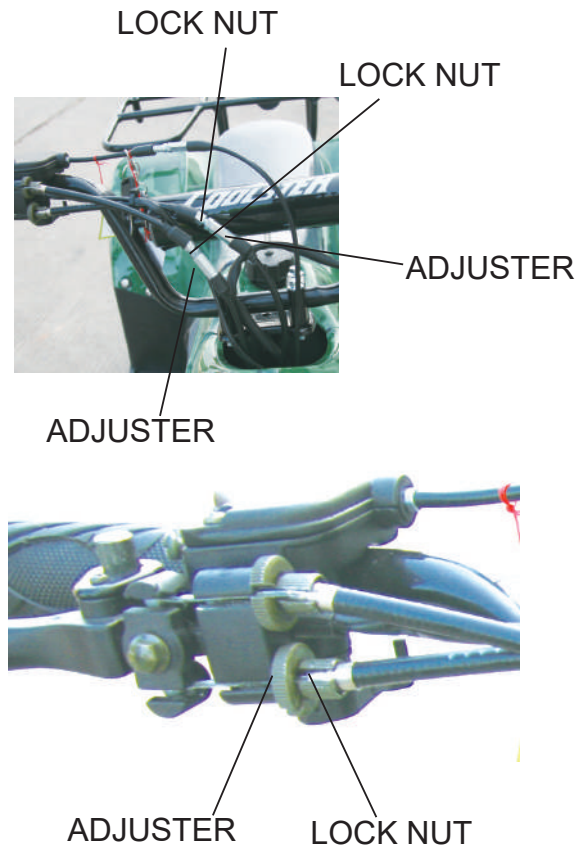

Drive Chain Tension Inspection

Rotate the wheel several times to identify the most compact location of the chain. When the chain is in its most compact position, check or adjust the chain tension.

The normal chain leeway is 10 to 20mm (13/32" - 19/32").

If the chain leeway is beyond 20mm, it should be tightened.



Drive Chain Adjustment

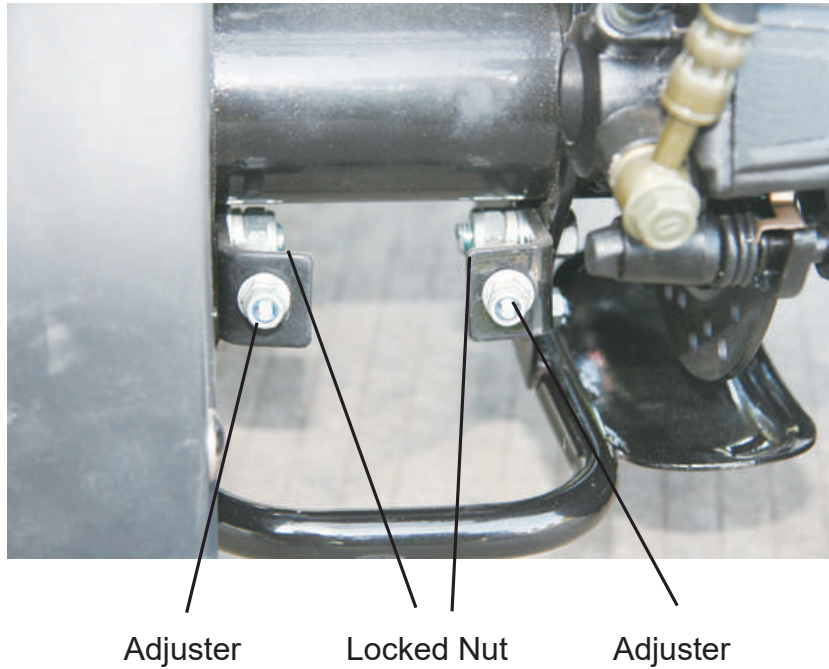

1. Fastening the chain regulator and the locking adjustment nut.
2. For tightening the chain, rotate the chain adjuster clockwise on the bottom of the lock nut, then adjust the nut. If the chain needs to loosen, turn the adjuster counter-clockwise.
3. Tighten all the loosen parts.
4. Tighten the chain accordingly to the screws and nuts.

Note: If the chain leeway is too loose, the chain can fall off during riding.

Drive Chain Lubrication

The chain includes many mutual operating parts. If the chain is not properly maintained, the chain can wear quickly. It is a must to carry out regular maintenance of the chain.

Regular maintenance is vital for preseving the structural integrity of the chain.

1. You may use any brand of spray-can lubricant. Before applying the lube, use a brush or cloth to remove all the dirt and mud deposits. Clean the roller next, then apply the lubricant.
2. Make sure the lubricant is applies immediately to prevent any risk of corrosion or rust.

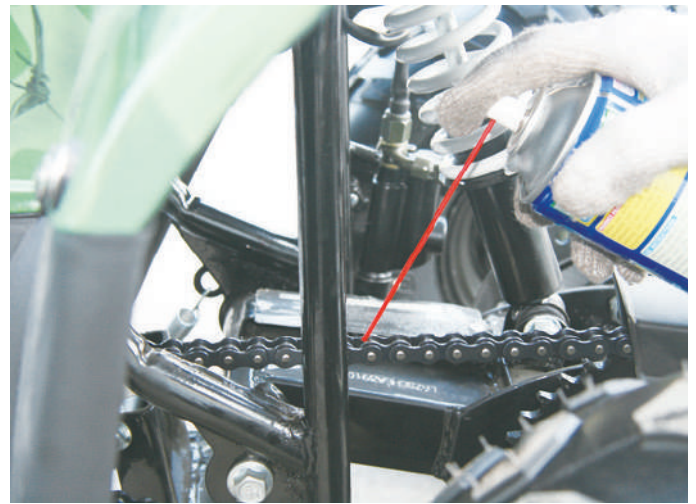

Battery

Check the battery electrolyte level and make sure the terminal and wiring of the battery casing is not leaking. If the electrolyte level is low, add distilled water.

Note: Check the battery electrolyte at least once a month.

WARNING

- When recharging batteries, allow 30 minutes for it to be cooled back to room temperature to ensure the proper use of batteries. Battery electrolyte is toxic and dangerous, as touching it will cause serious burns. The electrolyte contains sulfuric acid. Avoid contact with skin, eyes or clothing.
- The battery also generates combustible gases. Keep away from sparks, flames, cigarettes, and any other flame sources. If the battery is sealed, ensure proper ventilation is available. Always use eye protection when interacting with the battery.
- The battery should be placed in an area un-accessible to children.

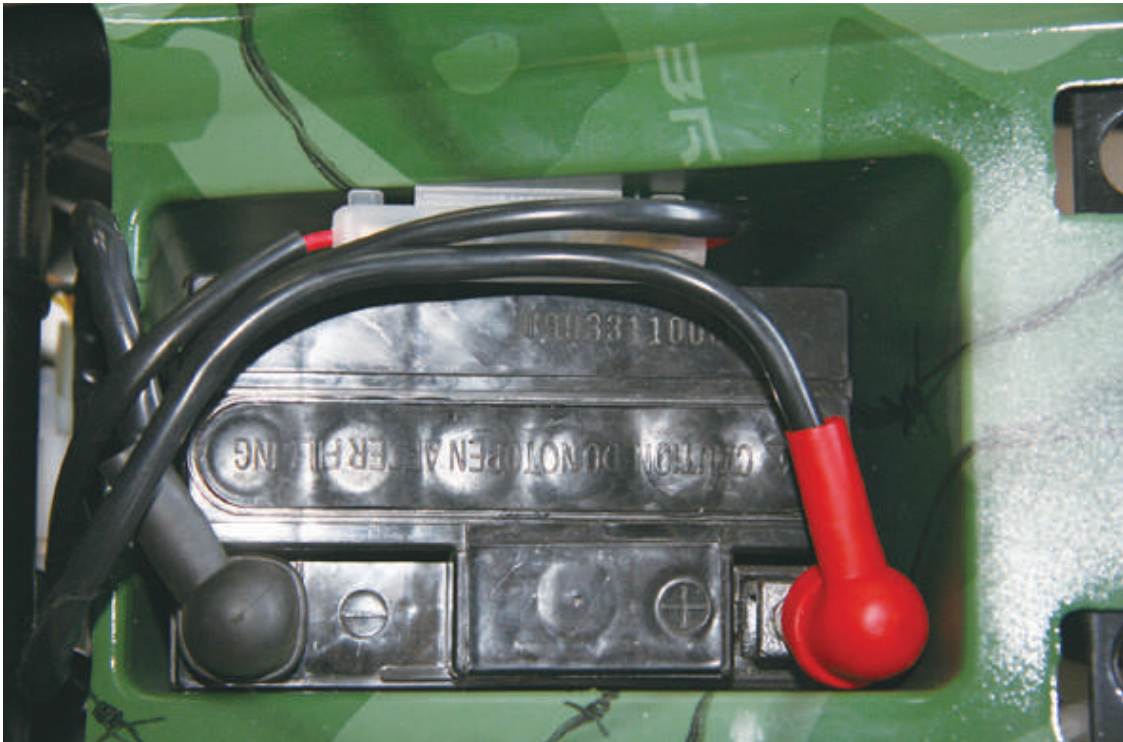

Replacement Fuse

The fuse box is connected to the wiring harness. When replacing, be mindful of the wiring and its connectors. After correct installation of the new fuse, connect the switch and observe the electrical functions. If you have trouble with installation, please your local Coolster dealer or repair shop.

Warning: Do not use the recommended ampere rating higher than the fuse. Doing so can cause large-scale damage to the electrical system and can potentially start a fire.

PROVIDES FUSE: 10 AMPS



Common fault causes and troubleshooting methods

Problem	Cause of Issue		Solution
Difficult or unable to start	1. There is no mixed gas in the cylinder	Air leakage in the intake system	Tighten the screw of the air inlet system seal
		The fuel circuit is blocked	Dredge the fuel circuit
	2. Fuel accumulates in the cylinder		Disassemble the spark plug to remove the oil accumulated in the cylinder
	3. The fuel is dirty or there is water		Clean the fuel tank, carburetor, and change the fuel
	4. Low cylinder compression	Spark plug leaks	Tighten the spark plug
		Air leakage at the joint surface of cylinder head and cylinder body	Wipe the plane, install the gasket, and tighten the nut
		Crankcase leaks	Replace the crankcase oil seal or disassemble the crankcase and recoat the sealant
		The piston ring or cylinder body is severely worn	Replace the piston ring or cylinder
		The piston ring is broken or clogged with carbon deposits	Replace the piston ring or unclog carbon deposits
	5. Poor exhaust	Carbon deposit in cylinder exhaust port or muffler	Remove carbon deposits
	6. Spark plug failure	A large amount of carbon deposits in the spark plug	Remove carbon deposits and clean with oil
		The spark plug insulator is damaged	Replace spark plug
		The spark plug gap is too large or too small	Replace or adjust
	7. Magneto failure	Short circuit or open circuit of low-voltage line	Find the short circuit or open circuit to repair or replace
		The igniter is damaged	Replace
		The ignition coil is damaged	Replace

Common fault causes and troubleshooting methods

Difficult or unable to start	8. Insufficient battery power (difficult to start)	Recharge battery or replace
	9. Weak pressure from the kick start rod. The grooves on the kick start screw are worn or kick starter falls off	Repair and replace
	10. Electric starter	The starter motor rotor is seizing Replace
	11. Other mechanical seizure failures, such as connecting rod needle roller bearings	Check and unclog
Unstable engine operation	1. Poor contact of the ignition wire	Reconnect
	2. Excessive carbon deposits between spark plug electrodes	Remove carbon deposits
	3. The fuel circuit is half blocked	Clear the fuel circuit
	4. Clutch slips	Replace
	5. Insufficient motor oil	Add motor oil
	6. The muffler is blocked	Clean and unclog
Engine stops automatically	1. The fuel cannot be supplied (the fuel circuit is blocked)	Check the fuel switch, carburetor, etc., for dredging
	2. Misfire	Check the electrical wiring in order from the spark plug to the magneto
	3. Cylinder is locked, the piston is seized	Repair or replace
	4. Other mechanical seizure failures	Repair or replace after identification
Insufficient engine power	1. The fuel circuit is blocked and the fuel supply is not smooth	Clear the fuel circuit
	2. The ignition time is too early or too late	Adjust ignition timing
	3. The spark is too weak	From the spark plug to the magneto
	4. Engine leak	Repair after identification
	5. The muffler is blocked	Dredge

Common fault causes and troubleshooting methods

The vehicle vibrates severely	1. The front and rear shock absorber springs are broken	Replace
	2. The shock absorber is not straight	Replace
	3. The shock absorber leaks oil	Replace
	4. The front and rear wheel bearings are damaged	Replace
Unstable driving direction	1. The direction rod is too tight or too loose for the relevant parts	Check the relevant parts
	2. Insufficient tire pressure	Inflate to the specified tire pressure
	3. The main frame, rear suspension, and/or front shock absorber are distorted, and the vehicle is improperly installed	Reinstallation and adjustment
	4. The front, middle and rear axles are loose	Adjust
Brake failure	1. The rear brake shoe is worn out	Replace
	2. Brake hubs are worn out	Replace
	3. Damaged front and rear brake cables	Replace
	4. The gap between the front and rear brakes is too large	Adjust or replace

Cleaning

1. In order to keep the vehicle clean and protect the appearance of the paint, cleaning should be done regularly. When cleaning, use a soft cloth or sponge dipped in water and cleaning liquid and gently scrub the outer surface to avoid residual buildup. After finishing, rinse the surface off with water.
2. Attention: When washing, avoid using high pressure water on the following parts.
 - (1) ignition switch
 - (2) multi-purpose switch
 - (3) under seat cushion
 - (4) exhaust pipe muffler
 - (5) air filter inlet
3. After the vehicle is thoroughly dried, start the engine and run for a few minutes. Inspect the remainder of the vehicle and make sure the brakes are fully functional.

Note: If the engine is still hot, do not wash. Allow it to cool to ambient temperature, then proceed with washing.

Storage

In order to preserve the condition of your vehicle, please follow the methods listed below for storage:

1. Select an ideal parking spot. The location should have security, ventilation, be moisture-proof, and have above-freezing conditions.
2. Make sure the conditions are not too hot, cold, dry or moist for engine lubricant.
3. Drain fuel tank and carburetor by allowing engine to run out of fuel, then use a fuel stabilizer.



If fuel is left in the tank, the fumes can become volatile. Make sure the tank is completely empty, and that the storage unit has good ventilation.

In order to prevent cylinder rust during long-term storage, please adopt the following measures:

1. Remove spark plugs. Make sure they are stored in a secure place.
2. Remove battery and store in a ventilated area away from children.
3. Wash and dry the vehicle, wax the paint surfaces, and apply antirust oil.
4. Bring the tire pressure up to the required standard air pressure. Boost the wheels up with blocks or pieces of wood so that the wheels do not contact the ground.
5. Cover the vehicle to protect from dust. Do not use plastic covers, as this can cause water vapor condensation and rust.

Transport

The vehicle should be properly secured on the transporter/trailer. There should also be effective preventative measures taken that can protect the vehicle against bumps, dips, or water.

Make sure the vehicle is securely fastened and has cushioning to help prevent against scratches or dents.

After Long Term Storage

1. Remove the sheets covering the vehicle and dust off the body. If vehicle has been in storage for more than 4 months, replace the engine oil.
2. Reinstall the battery and check for any leaks.
3. Add fuel to the fuel tank.
4. Continue with the rest of the pre-ride inspection.
5. Before committing to full operation of the vehicle, test the vehicle out first in a safe and closed-off area.

Safe Operation

Loaded ATV:

As originally equipped, this ATV is not designed to carry cargo or tow a trailer. If you choose to add accessories to carry cargo, do not exceed the maximum loading limits for the vehicle (see “MAXIMUM LOADING LIMIT” on vehicle labeling).

Avoid hills and rough terrain. Choose terrain carefully. Use extreme caution when towing or carrying a load on inclines.

Use extra caution when riding the ATV with additional loads, such as accessories or cargo. The ATV’s handling may be adversely affected. Reduce your speed when adding additional loads. Turn gradually and go slowly.

WARNING

Overloading can cause loss of control.
Loss of control can result in severe injury or death.

- Maximum weight capacity: 143 lbs. (65 kg)

Safe Operation

- Complete the recommended safety training before operating this vehicle.
- Do not allow anyone under age 6 to operate the vehicle.
- Never consume alcohol or drugs (over the counter or prescription medication included) before or while operating this vehicle.
- Always keep your feet on the footboards during operation; otherwise, they may contact the rear wheels. **WARNING!** Removing even one hand or foot can reduce your ability to control the ATV or could cause you to lose your balance and fall off of the ATV. If you remove a foot from a footboard, your foot or leg may come into contact with the rear wheels, which could injure you or cause an accident.
- Engine exhaust fumes are poisonous. Never start the engine or let it run in an enclosed area.
- Never allow a child to handle gasoline.
- Do not ride in areas posted “no trespassing”.
- Do not ride on private property without getting permission.
- Know the terrain where you ride. Ride cautiously in unfamiliar areas. Stay alert for holes, rocks, or roots in the terrain, and other hidden hazards which may cause the ATV to upset.
- **WARNING!** The ATV could go out of control if you do not have enough time to react to hidden rocks, bumps, or holes. Go slowly and be extra careful when operating on unfamiliar terrain.
- Always be alert to changing terrain conditions when operating the ATV.
- Select a large, flat area off-road to become familiar with your ATV. Make sure that this area is free of obstacles and other riders. You should practice control of the throttle, brakes, and turning techniques in this area before trying more difficult terrain.
- With the engine idling, release the parking brake. Apply the throttle slowly and smoothly. You will start to accelerate. If the throttle is applied too abruptly, the vehicle may lurch forward or the front wheels may lift off the ground, resulting in a loss of directional control.
- Avoid higher speeds until you are thoroughly familiar with the operation of your ATV.
- When slowing down or stopping, release the throttle and apply the brakes smoothly and evenly.
- Improper use of the brakes can cause the tires to lose traction, reducing control and increasing the possibility of an accident.
- Do not touch hot exhaust system components. Always keep combustible materials away from the exhaust system.
- Always remove the ignition key when the vehicle is not in use to prevent unauthorized use.



Avoid wheelies and jumping. Attempting wheelies, jumps, and other stunts increases the chance of an accident, including an overturn. Never attempt stunts, such as wheelies or jumps.



This ATV is designed for off-road use only. Paved surfaces may seriously affect handling and control of the ATV, and may cause the ATV to go out of control. Always avoid paved surfaces, including sidewalks, driveways, parking lots and streets.



Do not ride on any public road, street, or highway. Riding on public roads can result in collisions with other vehicles. Never operate this ATV on any public street, road or highway, even dirt or gravel roads. You could collide with another vehicle.

Turning - Your ATV is equipped with a solid rear axle, which drives both rear wheels equally at all times. This means that the wheel on the outside of the turn must travel a greater distance than the inside wheel when turning, and the inside tire must slip traction slightly. To turn, steer in the direction of the turn, leaning your upper body to the inside of the turn while supporting your weight on the outer footrest. This technique alters the balance of traction between the rear wheels, allowing the turn to be made smoothly

Practice making turns at slow speeds.



Turning improperly can result in vehicle overturning. Never turn abruptly or at sharp angles. Never turn at high speeds.

Safe Operation

Driving Uphill – Braking and handling are greatly affected when operating in hilly terrain. Improper procedure could cause loss of control or overturn. Whenever traveling uphill, follow these precautions:

1. Drive straight uphill.
2. Avoid steep hills (15° maximum).
3. Always check the terrain carefully before ascending any hill.
4. Never climb hills with excessively slippery or loose surfaces.
5. Keep both feet on the footrests.
6. Shift body weight uphill.
7. Proceed at a steady rate of speed and throttle opening. Opening the throttle suddenly could cause the ATV to flip over backwards.
8. Never go over the top of any hill at high speed. An obstacle, a sharp drop, or another vehicle or person could be on the other side of the hill.
9. Remain alert and be prepared to take emergency action. This may include quick dismounting of the vehicle.

Safe Operation

Driving on a Sidehill – Driving on a sidehill is not recommended. Improper procedure could cause loss of control or overturn. Avoid crossing the side of any hill unless absolutely necessary.

If crossing a sidehill is unavoidable, follow these precautions:

1. Slow down.
2. Lean into the hill, transferring your upper body weight uphill while keeping your feet on the footrests.
3. If the vehicle begins to slide or tip, quickly turn the front wheel downhill, if possible, or dismount on the uphill side immediately!

Safe Operation

Driving Downhill – When driving downhill, follow these precautions:

1. Avoid steep hills (15° maximum).
2. Shift body weight uphill. Transfer your weight to the rear of the vehicle.
3. Drive straight downhill.
4. Slow down. Excessive speed when traveling downhill can cause loss of control.
5. Apply the brakes very slightly to aid in slowing.

Safe Operation

Turning Around on a Hill – If the vehicle stalls while climbing a hill, never back it down the hill! Use the K-turn to turn around.

1. Stop the vehicle and lock the parking brake while keeping body weight uphill.
2. Shut off the engine.
3. Dismount on the uphill side of the vehicle, or on the left if the vehicle is pointing straight uphill.
4. Staying uphill of the ATV, turn the handlebars full left.
5. While holding the brake, release the parking brake lock and slowly release the brake, allowing the ATV to roll around to your right until it's pointing across the hill or slightly downward.
6. Lock the parking brake and remount the ATV from the uphill side, keeping body weight uphill.
7. Restart the engine and squeeze the brake lever.
8. Release the parking brake and drive slowly, controlling speed with the brake, until the ATV is on more level ground.

Safe Operation

Parking on a Hill or Incline – Avoid parking on a hill or incline if possible. If it's unavoidable, follow these precautions:

1. Stop the engine.
2. Lock the parking brake.
3. Always block the rear wheels on the downhill side.

Safe Operation

Driving on Slippery Surfaces – Whenever riding on slippery surfaces such as wet trails or loose gravel, or during freezing weather, follow these precautions:

1. Do not operate on excessively rough, slippery or loose terrain.
2. Slow down when entering slippery areas.
3. Maintain a high level of alertness, reading the trail and avoiding quick, sharp turns, which can cause skids.
4. Never apply the brakes during a skid. Correct a skid by turning the handlebars in the direction of the skid and shifting your body weight forward.

Safe Operation

Driving Over Obstacles – Follow these precautions when operating over obstacles:

1. Always check for obstacles before operating in a new area.
2. Look ahead and learn to read the terrain. Be constantly alert for hazards such as logs, rocks and low hanging branches.
3. Travel slowly and use extra caution when operating on unfamiliar terrain. Not all obstacles are immediately visible.
4. Never attempt to operate over large obstacles, such as rocks or fallen trees.

Safe Operation

Driving Through Water – Your ATV can safely operate through shallow water. The recommended maximum depth for your ATV is below the bottom of the footrests. Follow these precautions when operating through water:

1. Determine water depth and current before entering water.
2. If crossing a stream, choose a crossing where both banks have gradual inclines.
3. Avoid operating through deep or fast-flowing water.
4. After driving through water, dry the brakes by applying light pressure to the levers (while moving) until braking action is normal. If you do not perform this procedure, your brakes may be ineffective.

Specifications

Model Number: ATV-3050C

Engine Type: Single Cylinder, 4-Stroke

Displacement: 107cc

Max Torque: 6.9N.m/6,500 ± 500r/min (N.m/r/min)

Max Power: 4.8kW/8,000 ± 500r/min (kW/r/min)

Bore & Stroke: 52.4 x 49.5mm

Ignition: CDI

Spark Plug Model: D7TC

Spark Plug Gap: 0.6~0.7 mm

Starting System: Electric

Battery: 12V, 4Ah

Clutch: Automatic

Transmission: Chain, Rear Wheel Drive

Brakes Front/Rear: Drum/Hydraulic Disc

Tires Front/Rear: 145/70-6 | 145/70-6

Fuel Type: 90 or Higher Octane, Unleaded Gasoline

Fuel Capacity: 0.54 gallons / 2.06L

Maximum Weight Capacity: 145 lbs / 65 kg (rider, all cargo and accessories)

Wheelbase: 850mm

Dimensions: 1,270 x 700 x 840mm

Min. Ground Clearance: 85mm

Passenger Capacity: Operator Only

Emissions Warranty Parts List

Fuel Metering System	Ignition System	Exhaust System	Emissions Control System
Carburetor, Fuel Tank	Spark Plug	Exhaust Manifold	Air Cleaner Housing
Fuel Line, Fuel Tank Cap	CDI	Ignition Coil, Pair Sys.	Air Cleaner Housing Cov.

Model Year: 2022 or Later Models

Manufacture Name: Zhejiang Qiye Scooter Co., LTD

Importer Name: Maxtrade LLC.

Emission-Related Part Numbers

ENGINE FAMILY	CARBURETOR	INTAKE MANIFOLD	SPARK PLUG	EXHAUST MANIFOLD	AIR CLEANER HOUSING COVER	CDI	IGNITION COIL	FUEL TANK	FUEL LINE	FUEL TANK CAP	PAIR SYSTEM
NMXTX.125MQ1 PMXTX.125MQ1 RMXTX.125MQ1 SMXTX.125MQ1 TMXTX.125MQ1 VMXTX.125MQ1 WMXTX.125MQ1 XMXTX.125MQ1	QIYE 11	QIYE 12	A7TC	QIYE 13	E4.GH110-1	QIYE 2	QIYE 4	QIYE 1	HONG YUN	QIYE 6	
NMXTX.125MQ4 PMXTX.125MQ4 RMXTX.125MQ4 SMXTX.125MQ4 TMXTX.125MQ4 VMXTX.125MQ4 WMXTX.125MQ4 XMXTX.125MQ4	QIYE 11A	QIYE 12	A7TC	QIYE 13	E4.GH110-1	QIYE 2A	QIYE 4	QIYE 1A	HONG YUN	QIYE 6	
NMXTX.072MQ7 PMXTX.072MQ7 RMXTX.072MQ7 SMXTX.072MQ7 TMXTX.072MQ7 VMXTX.072MQ7 WMXTX.072MQ7 XMXTX.072MQ7	QIYE 41	QIYE 42	A7TC	QIYE 43	E4.GH110-1	QIYE 2A	QIYE 5	QIYE 1C	HONG YUN	QIYE 6	
NMXTX.170MQ5 PMXTX.170MQ5 RMXTX.170MQ5 SMXTX.170MQ5 TMXTX.170MQ5 VMXTX.170MQ5 WMXTX.170MQ5 XMXTX.170MQ5	QIYE 31	QIYE 32	A7TC	QIYE 33	QIYE 35	QIYE 3	QIYE 8	QIYE 1E	HONG YUN	QIYE 6B	QIYE 50
NMXTX.170MQ2 PMXTX.170MQ2 RMXTX.170MQ2 SMXTX.170MQ2 TMXTX.170MQ2 VMXTX.170MQ2 WMXTX.170MQ2 XMXTX.170MQ2	QIYE 31	QIYE 32	A7TC	QIYE 33	QIYE 35	QIYE 3	QIYE 8	QIYE 1D	HONG YUN	QIYE 6A	
NMXTX.200MQ3 PMXTX.200MQ3 RMXTX.200MQ3 SMXTX.200MQ3 TMXTX.200MQ3 VMXTX.200MQ3 WMXTX.200MQ3 XMXTX.200MQ3	QIYE 31A	QIYE 52	D8RT C5.XY 1.020	QIYE 53	QIYE 45	QIYE 3A	QIYE 8A	QIYE 1D	HONG YUN	QIYE 6A	QIYE 50

Electrical Diagram

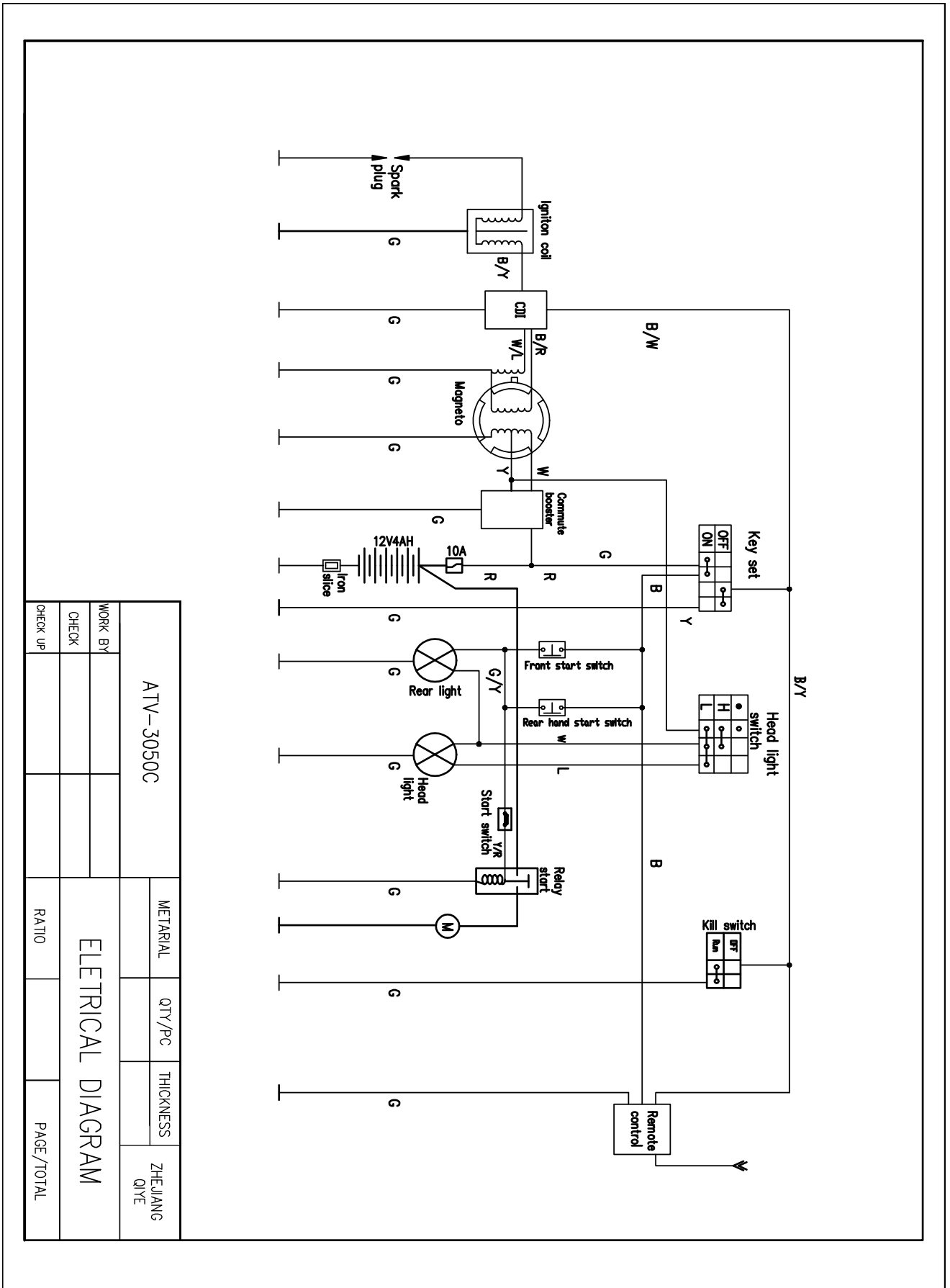

ATV-3050C		ZHEJIANG QIYE	
WORK BY		MATERIAL	
CHECK		QTY/PC	
CHECK UP		THICKNESS	
ELECTRICAL DIAGRAM		RATIO	
		PAGE/TOTAL	

⚠ WARNING

Improper ATV use can result in SEVERE INJURY or DEATH



**ALWAYS USE
AN APPROVED
HELMET AND
PROTECTIVE
GEAR**



**NEVER USE
ON PUBLIC
ROADS**



**NEVER CARRY
PASSENGERS**



**NEVER USE
WITH DRUGS
OR ALCOHOL**

NEVER operate:

- without proper training or instruction
- at speeds too fast for your skills or the conditions
- on public roads - a collision can occur with another vehicle
- with a passenger - passengers affect balance and steering and increase risk of losing control

ALWAYS:

- use proper riding techniques to avoid vehicle overturns on hills and rough terrain and in turns
- avoid paved surfaces - pavement may seriously affect handling and control

**LOCATE AND READ OWNER'S MANUAL.
FOLLOW ALL INSTRUCTIONS AND WARNINGS.**

