



LifePod™

INSTRUCTION MANUAL

Visit www.vaulteksafe.com/lifepod-support for online tutorials, quick setup help, and FAQs.

STEP ONE: Battery Installation

- 1 To get started, undo both side compression latches to open your LifePod™.
- 2 Locate the battery cover on the front wall and remove by pressing on the outer tab (Fig A).
- 3 Carefully pull out the 9v battery snap inside the battery compartment, and connect an Alkaline 9V battery to the connector. Be sure to snap the battery in the correct orientation (Fig B). A 9v Alkaline battery is not included.
- 4 When the battery is snapped in you will hear a short welcome tone and the keypad will light up.
- 5 Once you hear the tone and see the keypad light up, slide the battery into its compartment being mindful to place the battery ribbon underneath the battery first (Fig C). This will make the battery easier to remove when replacing.
- 6 Replace the battery cover and you are ready to program your LifePod™.

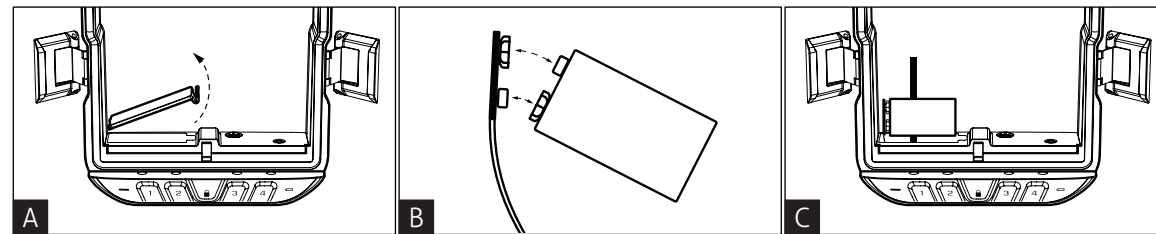

STEP TWO: Basic Operation

With the battery installed, you can now lock and unlock your LifePod™. Unique to LifePod™ is a capacitive keypad. There are no physical buttons, but each key can be pressed by touching the keypad surface.

Locking

IMPORTANT Before locking your LifePod™, always be sure the side compression latches are latched closed first. This will ensure the locking mechanism engages properly.

Unlocking

IMPORTANT Do not undo the compression latches until the unit has been unlocked with the correct master code first. Undoing the compression latches first may cause binding on the lock mechanism and will not unlock.

- 1 First tap the lock pad to wake the unit up (Fig D). When the keypad lights up, your LifePod™ is awake and ready to accept the code.
- 2 Enter the master code. (The default master code is 1-2-3-4). When the code is correct, the status LED will turn GREEN and the lock will disengage.
- 3 Undo both side compression latches, and you can open the unit.

TIP! Your LifePod™ can protect your belongings against the elements using the side compression latches alone. For extra security, lock the unit with the lock pad as needed.

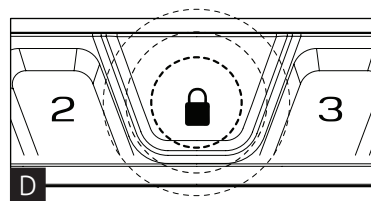

- 1 To lock, simply press and hold the lock pad for 2 seconds (Fig D).

STEP THREE: Master Code Programming

First time users should change the default code as soon as possible to prevent unauthorized access when using the lock.

TIP: Code Requirements

- Your code can be a minimum of 4 digits, or as long as 8 digits.
- Two keys can not be pressed simultaneously.
- Programming a new code will overwrite your previous code.

The PROGRAM button will not function when locked. Be sure LifePod™ latch is in unlocked position.

- 1 First open the unit and tap the lock pad to wake the unit up (Fig K). When the keypad lights up, your LifePod™ is awake and ready for programming.
- 2 Press and hold the PROGRAM button for 3 seconds (Fig L) until ALL keys (1-4) turn solid RED.
- 3 Enter your new code.
- 4 Press and hold the PROGRAM button a second time for 3 seconds (Fig L) until ALL keys (1-4) turn solid RED.
- 5 Enter your new code a second time.
- 6 Press and hold the PROGRAM button a third time for 3 seconds (Fig L). The status LED (Fig M) will flash GREEN and LifePod™ will beep to confirm the code change is successful.

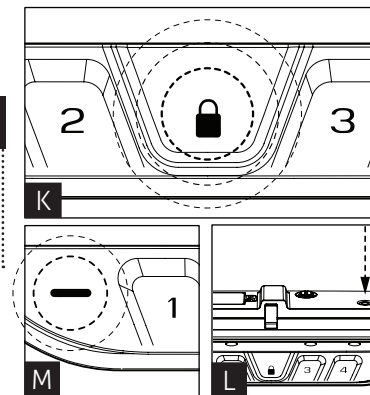

Tip! Water will affect the keypad performance. Wipe away excess water and dry off the keypad when opening for best results and to prevent unwanted water from entering the storage compartment.

STEP FOUR: Product Registration

Vaultek® strongly encourages you to register your LifePod™ as soon as you receive it. Registration provides many benefits including technical support and ordering replacement keys should you misplace them. Your Vaultek® LifePod™ has a unique product number on the inside of the battery door and a 4-digit ID number engraved on the keys. You will need these numbers to register your new unit.

- 1 Locate your product number. It is printed on the first page of this user manual and on the back of the battery door (Fig H).
- 2 Find your 4-digit ID number engraved on the keys (Fig I).
- 3 Please visit the Vaultek® website at vaulteksafe.com and click Support then click Registration from the available options.
- 4 Enter the required information in the form and click submit.

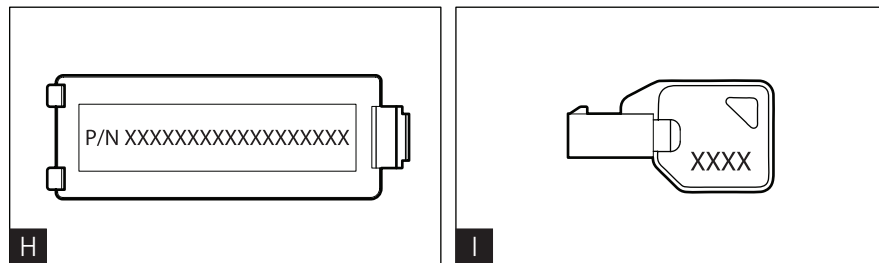

Quick Setup

Table of Contents

Overview / Introduction	01 / 02	Box Contents
Warnings	03	VLP 1.0 LifePod™
Basic Operation	04	Tether Lanyard
Battery Installation	05	(2) Backup Manual Keys
Using the Micro-USB Port	06	User Guide
Backup Key Access	06	Tutorial Videos
Compression Latches	07	Install your Battery
Master Code Programming	08	How to Register your LifePod™
Key Lock	09	Change your Master Code
Product Registration	10	Secure your LifePod™
LED Indicators	11	Accessory Kits
Status LED	11	+ More Videos Online
Tamper Detection	11	
Battery Indicator	11	
Locked Status	11	
Securing your LifePod™	12	
Customer Support / Warranty	13	
FAQ	14	

Get Started

Visit vaulteksafe.com/lifepod-support for online tutorials, quick setup help, and FAQs.

Overview

Get to know your Vaultek® LifePod™.

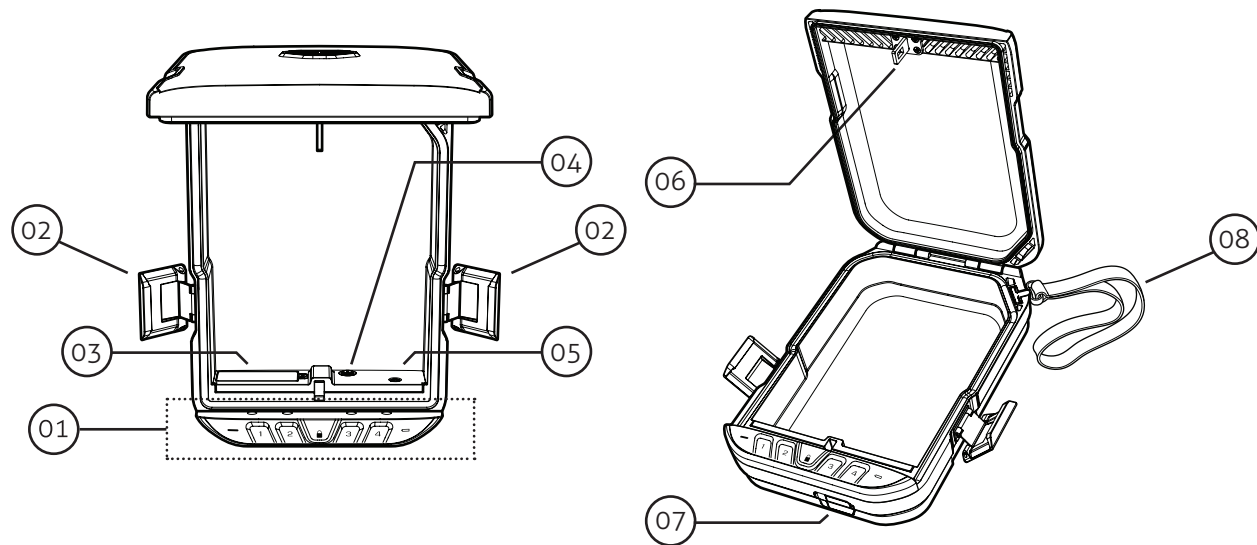

01. Capacitive Keypad

04. Key Lock

07. Keyhole/Micro-USB Cover

02. Side Compression Latches

05. Program Button

08. Tether Lanyard

03. Battery Cover

06. Anti-Impact Latch

Introduction

The Vaultek® LifePod™ is a pin access portable lockbox. It can be secured using the side compression latches to protect the interior from environmental factors such as water, with the added option of securely locking the unit with the keypad. It's high impact polymer and portable design makes it ideal to transport and protect valuables and personal items. Powered by an Alkaline 9V battery (not included), LifePod™ combines security with convenient access.

Secure Access: How to open your Vaultek® LifePod™.

Keypad: The 4 digit capacitive keypad responds quickly for access and has a built in proximity sensor that lights up the keypad when the lock pad is touched. See page 08 for more information.

Key: Two keys are provided for manual access to the safe in the event the battery dies.

Secure Defense: How your Vaultek® LifePod™ keeps people out.

Anti-Impact Latch: Built to withstand forceful impacts.

High Impact Polymer: Engineered to be extremely strong and impact resistant.

Anti-Pry Design: The interior channels and gasket form a seal around the inner chamber making it difficult for tools and other small objects to penetrate.

Security Tether: An included security tether and optional security cable (purchased separately) can be used to secure LifePod™ to a stationary object.

Security Sleep Mode: Activates when (6) consecutive incorrect keypad entries are entered. LifePod™ will not accept any entries for four minutes. If a key is pressed during this time, all of the keys will flash RED and the alarm beeps. A backup key can be used to open the unit.

Warnings

To prevent damage to your LifePod™ or injury to yourself or to others, read the following safety precautions before using this unit.

IMPORTANT Before locking your LifePod™, always be sure the side compression latches are latched closed first. This will ensure the locking mechanism engages properly.

IMPORTANT Do not undo the compression latches until the unit has been unlocked with the correct master code first. Undoing the compression latches first may cause binding on the lock mechanism and will not unlock.

DO NOT submerge in water more than 1 foot deep. The pressure could leak water into the inner chamber. LifePod™ is designed to protect against dust and splashes with brief short immersions and will float when loaded with weight up to 2lb.

DISCLAIMERS:

Neither seller nor manufacturer shall be liable for any injury, loss or damage, direct or consequential, arising out of the use of, or the inability to use, the Vaultek® LifePod™.

The user shall determine the suitability of the Vaultek® LifePod™ before the intended use and user assumes all risk and liability whatsoever in connection therewith.

To ensure proper weather sealing:

ALWAYS check that the rubber gasket is free of debris before closing the lid

ALWAYS check that the side compression latches are fully engaged and closed

ALWAYS check that the front rubber cover is closed tightly

DO NOT expose to extreme heat or cold. Battery power may be affected. Acceptable operation range is -14 °f to 120 °f.

DO NOT store loaded firearms in this unit.

Basic Operation

LifePod™ can protect belongings from environmental factors using the side compression latches alone without the need for a battery.

With the battery installed LifePod™ can lock securely using a built in locking mechanism for additional security. Unique to LifePod™ is a capacitive keypad. There are no physical buttons, but each key can be pressed by touching the keypad surface.

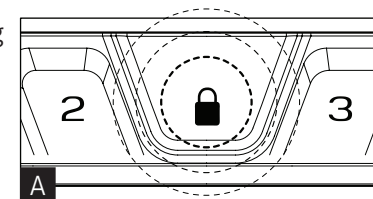

Locking

IMPORTANT Before locking your LifePod™, always be sure the side compression latches are latched closed first. This will ensure the locking mechanism engages properly.

Unlocking

IMPORTANT Do not undo the compression latches until the unit has been unlocked with the correct master code first. Undoing the compression latches first may cause binding on the lock mechanism and will not unlock.

- 1** First tap the lock pad to wake the unit up (Fig A). When the keypad lights up, your LifePod™ is awake and ready to accept the code.
- 2** Enter the master code. (The default master code is 1-2-3-4). When the code is correct, The status LED will turn GREEN and the lock will disengage.
- 3** Undo both side compression latches, and you can open the unit.

- 1** To lock, simply press and hold the lock pad for 2 seconds (Fig A).

Battery Installation

LifePod™ is powered by 9v Alkaline battery (not included). Under normal use the battery can last up to one year.

- 1 To get started, undo both side compression latches to open your LifePod™.
- 2 Locate the battery cover on the front wall and remove by pressing on the outer tab (Fig B).
- 3 Carefully pull out the 9v battery snap inside the battery compartment, and connect an Alkaline 9V battery to the connector. Be sure to snap the battery in the correct orientation (Fig C). A 9v Alkaline battery is not included.
- 4 When the battery is snapped in you will hear a short welcome tone and the keypad will light up.
- 5 Once you hear the tone and see the keypad light up, slide the battery into its compartment being mindful to place the battery ribbon underneath the battery first (Fig D). This will make the battery easier to remove when replacing.
- 6 Replace the battery cover and you are ready to program your LifePod™.

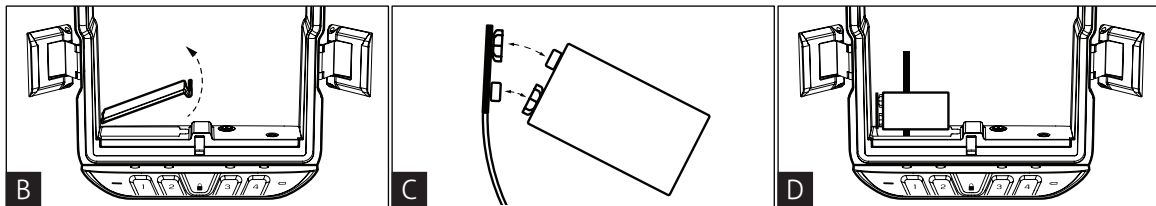

Using the Micro-USB Port

A micro-USB port is built into LifePod™ behind the front protective rubber cover (Fig E).

In the event the battery dies while traveling, and you do not have access to the backup keys, you can power on the unit using the backup micro-USB port.

Simply open the rubber cover and plug in a micro-USB cable (not included) into the port. While the cable is plugged into an external power source, LifePod™ will function normally allowing you to enter the code and open the unit.

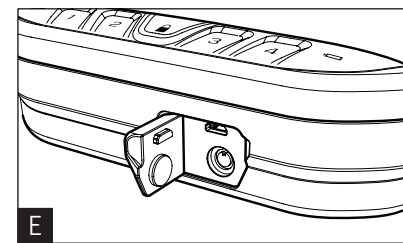

Backup Key Access

The keyhole is located beneath the front protective rubber cover (Fig E).

Two backup keys are provided. In the event these are needed to open the LifePod™, simply open the protective cover, insert one of the backup keys, and turn the key clockwise 90 degrees (Fig F).

IMPORTANT! Always make sure the front protective cover is closed tightly to ensure the unit is sealed correctly for protection from the elements.

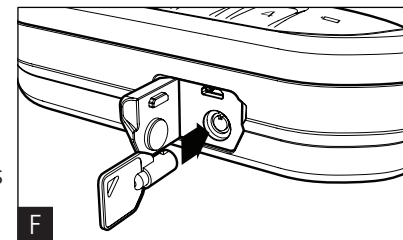

Compression Latches

LifePod's side compression latches can protect belongings from environmental factors using the side latches alone without the need for a battery.

To Open simply lift from the bottom of each latch away from the unit (Fig G). The latches will lift and disengage, then swing the latches free of the unit (Fig H). The top lid can now be opened.

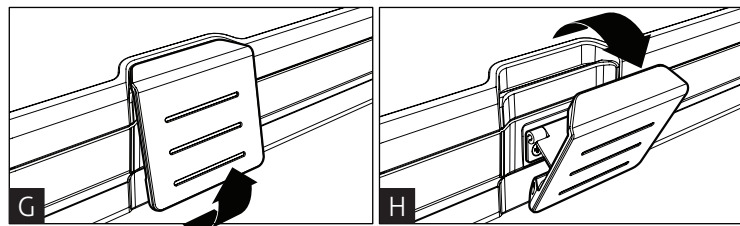

To Close rest the top of each latch against the top housing (Fig I). The latches will catch and rest in place on their own. Press the bottom of each latch firmly towards the unit to engage (Fig J). You will hear and feel the latches snap in position.

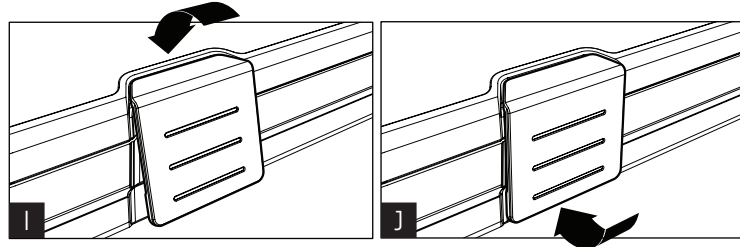

Master Code Programming

First time users should change the default code as soon as possible to prevent unauthorized access when using the lock.

TIP: Code Requirements

- Your code can be a minimum of 4 digits, or as long as 8 digits.
- Two keys can not be pressed simultaneously.
- Programming a new code will overwrite your previous code.

The PROGRAM button will not function when locked. Be sure LifePod™ latch is in unlocked position.

- 1 First open the unit and tap the lock pad to wake the unit up (Fig K). When the keypad lights up, your LifePod™ is awake and ready for programming.
- 2 Press and hold the PROGRAM button for 3 seconds (Fig L) until ALL keys (1-4) turn solid RED.
- 3 Enter your new code.
- 4 Press and hold the PROGRAM button a second time for 3 seconds (Fig L) until ALL keys (1-4) turn solid RED.
- 5 Enter your new code a second time.
- 6 Press and hold the PROGRAM button a third time for 3 seconds (Fig L). The status LED (Fig M) will flash GREEN and LifePod™ will beep to confirm the code change is successful.

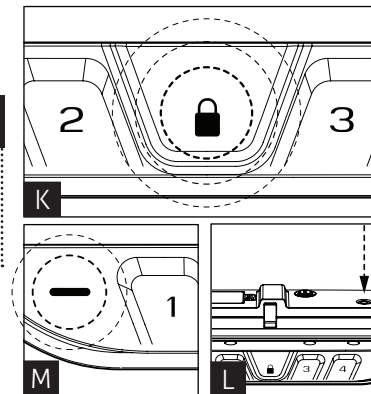

Tip! Water will affect the keypad performance. Wipe away excess water and dry off the keypad when opening for best results and to prevent unwanted water from entering the storage compartment.

Key Lock

Your LifePod™ is equipped with an anti-hacking feature for enhanced security. Using the key lock, you can disable the exterior lock from functioning.

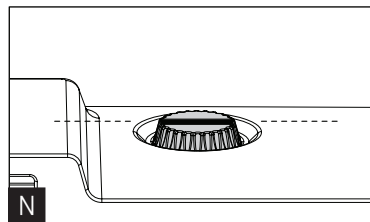

OFF (Fig N) Default setting. The exterior lock is engaged and fully functional.

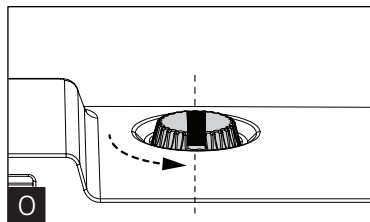

ON (Fig O) The exterior lock is disengaged. Meaning LifePod's lock can not be picked open by any hacking and renders the lock useless.

IMPORTANT When key lock is ON, the backup keys will not be able to open the unit. Use with caution. In the event of battery failure, the micro-USB port can still be used to provide power and open the unit.

Product Registration

Vaultek® strongly encourages you to register your safe as soon as you receive it. Registration provides many benefits including technical support and ordering replacement keys should you misplace them. Your Vaultek® LifePod™ has a unique product number on the inside of the battery door and a 4-digit ID number engraved on the keys. You will need these numbers to register your new unit.

- 1 Locate your product number. It is printed on the first page of this user manual and on the back of the battery door (Fig P).
- 2 Find your 4-digit ID number engraved on the keys (Fig Q).
- 3 Please visit the Vaultek® website at vaulteksafe.com and click Support then click Registration from the available options.
- 4 Enter the required information in the form and click submit.

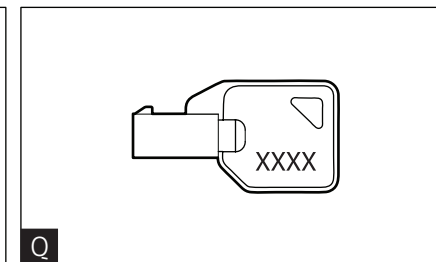
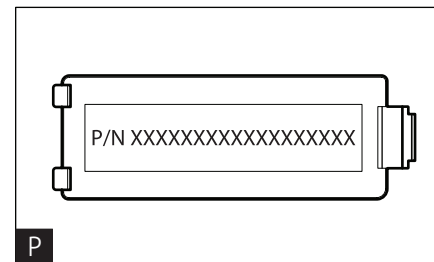

LED Indicators

LifePod's capacitive keypad has multiple LEDs built in to provide various feedback. The LEDs will illuminate as needed when the unit is awake. To wake the unit, tap the lock pad to illuminate the keypad.

Status LED (Fig R) The status LED will provide feedback on various commands. It will light GREEN when correct codes are entered and RED when an incorrect code is entered.

Tamper Indication (Fig R) If the status LED is solid RED when awake, this means the unit has detected that an incorrect code has been entered. You can clear the tamper indicator by entering the correct master code.

Battery Indicator (Fig S) When the unit is awake, the battery indicator will light either GREEN or RED. Green indicates the battery has sufficient power, and Red indicates the battery is in need of replacement.

Lock Pad (Fig T) The lock pad illuminates RED only when the unit has been locked using the keypad, and requires the use of the master code to unlock it. When locked, and the unit is awake, the lock icon will be solid RED.

TIP! If the lock icon is solid RED, do not undo the side compression latches to open the unit. This means the internal lock is engaged and should not be opened. Enter the master code to unlock the unit, as indicated by the lock icon light going OFF. It is now safe to undo the side latches and open the unit.

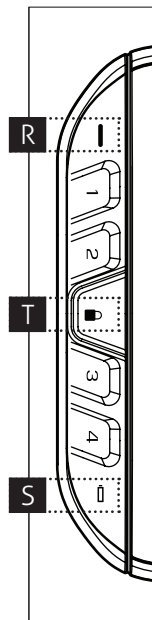

Securing your LifePod™

Included is a tether lanyard that can be used to secure the LifePod™ to a fixed object.

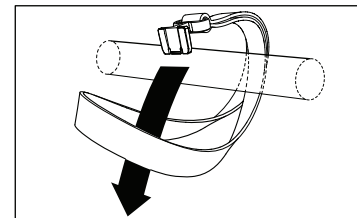

1 First wrap the looped end of the tether around an object of your choice, such as a seat bracket under your vehicle's seat.

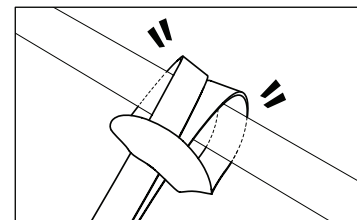

2 Pull the adapter piece through the loop, and cinch tight.

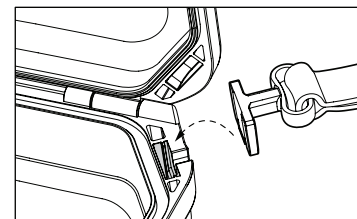

3 Place the adapter piece in its slot in the LifePod™, and close the lid.

TIP! A heavy duty steel security cable can be purchased separately if preferred.

Customer Support / Warranty

If you have a problem with your Vaultek® LifePod™ that is not answered in the FAQ section of this manual, we encourage you to visit www.vaulteksafe.com/lifepod-support/.

Limited Warranty (Terms and Conditions)

VAULTEK® IS COMMITTED TO PROVIDING PRODUCTS OF HIGH QUALITY AND VALUE AND MAKES EVERY EFFORT TO ENSURE ITS PRODUCTS ARE FREE OF DEFECTS.

Vaultek® guarantees your LifePod™ will be free of defects in materials or workmanship for a period of one year from the date of original purchase from an authorized dealer.

The warranty is only valid for the original purchaser and not transferable. This warranty is only valid for products purchased and operated in the U.S. This warranty does not cover abuse, misuse, use in any manner for which is not designed, neglected, modification, damage inadvertently caused by the user, accidents and/or tampering.

If service is needed Vaultek® will, at its option, exchange or repair without charge for parts or labor. Upon authorization of warranty service, customers

are responsible for securely packaging product. Additionally, customers are responsible for costs of shipping to and from Vaultek® service center.

If the claimed defect cannot be identified or reproduced, customers will be held responsible for the costs incurred. Please have the following information available before you begin a claim with Vaultek®:

- Purchaser's name, mailing address, email address, and a phone number.
- Copy of receipt or online order number (if purchased directly from us or Amazon)
- Authorized Dealer Name (if applicable)
- Detailed description of the problem

NEITHER SELLER NOR MANUFACTURER SHALL BE LIABLE FOR ANY INJURY, LOSS OR DAMAGE, DIRECT OR CONSEQUENTIAL, ARISING OUT OF THE USE OF, OR THE INABILITY TO USE THE VAULTEK® LIFEPOD™.

FAQ More online at vaulteksafe.com under Support

Q: How long will my battery last?

A: A new 9v Alkaline battery will last up to one year with normal use. Normal use is locking and unlocking the LifePod™ 1-2 times per day.

Q: What type of battery does my Vaultek® LifePod™ use?

A: Use a standard Alkaline 9V battery. Non-alkaline 9V batteries will provide shorter battery life.

Q: How do I unlock the case if the battery is dead but the case is locked?

A: Plug a micro-USB cable into the front micro-USB port to power the unit so you can unlock and replace the battery.

Q: Is my LifePod™ fireproof or waterproof?

A: LifePod™ is not fireproof, but is waterproof up to 1 foot deep. It is designed to stay afloat in the water with weight up to 2lb.

Q: Can I use the compression latches by themselves and not lock the unit?

A: Yes, the compression latches are designed to seal the interior chamber from the elements and great for recreational use. The lock can be used when a higher level of security is needed.

Q: What do I do when my keypad is unresponsive?

A: Your battery is likely dead. Replace the battery with a new 9v Alkaline battery.

Q: What happens if I lose the keys?

A: First, make sure you registered your LifePod™ in the event you do lose your keys. Contact us at support@vaulteksafe.com. Be prepared to provide your order details and product number to us so we can verify ownership.

Q: Can I travel with my LifePod™ through US Customs or TSA security at the airport?

A: Yes, LifePod™ qualifies as a secured lockbox for traveling. If transporting firearms, be sure to inform your airline agent when checking in due to Federal law. Be aware, that you may be asked to open your LifePod™, and person having the master code should be present in case such a request is made by a government authority.

Q: What happens if the lid is not opening?

A: If you have been traveling the atmospheric pressure difference could create a vacuum holding the lid down. Release the pressure by opening the key hole cover.

FCC

NOTE: This device complies with part 15 of the FCC Rules. Operation is subject to the following two conditions: (1) This device may not cause harmful interference, and (2) this device must accept any interference received, including interference that may cause undesired operation.

STOP! Do not return to retailer. If you have any questions about your Vaultek® LifePod™ or need help configuring the system, please contact us at vaulteksafe.com.

Visit the support tab at vaulteksafe.com for FAQ, troubleshooting, and additional tutorials.



VAULTEK®

37 North Orange Ave. Suite 800B Orlando, FL 32801

VAULTEKSAFE.COM

REV 011220