



GUN STORAGE SOLUTIONS





855-647-8673
www.GunStorageSolutions.com

Gun Safe Accessories

pg. 4



Gun Display Accessories

pg. 16



Gun Safe Accessories



RIFLE RODS

(Pg. 6-9)

Condense long guns into a smaller space and access them easier than ever. Rifle Rods work with shotguns, ARs, double barrels and optics. Don't buy another safe, retrofit your gun safe today!

NOW IN 3 COLORS!



HANDGUN STORAGE

(Pg. 10-11)



Individual pistol storage hangers adapt to a standard shelf. Great for small or large spaces. Easy access to guns. Made for different areas on or below a shelf.

OTHER PRODUCTS

(Pg. 12-13)



MagMinder

Safe Savers add airflow underneath and help level gun safes. MagMinders clear off shelf space and organize magazines.

STORAGE MAGNETS

(Pg. 14-15)



Magnetic magazine and gun mounts. Easy and versatile. For use in many applications.

Maximize Space

Gun Safe Accessories



Rifle Rods

Is your safe full? Think again!

Rifle Rods act as a stabilizing device to stand guns in the upright position, rather than leaning into racks. The simplicity and versatility of this hook and loop system works with most storage environments - safes, cabinets, closets.

This infinitely adjustable storage system allows you to condense long guns into a fraction of the space and access them easier than ever.

Increase Capacity

Easy access to back row

Great for scopes/optics



RIFLE RODS + SHELF LINER

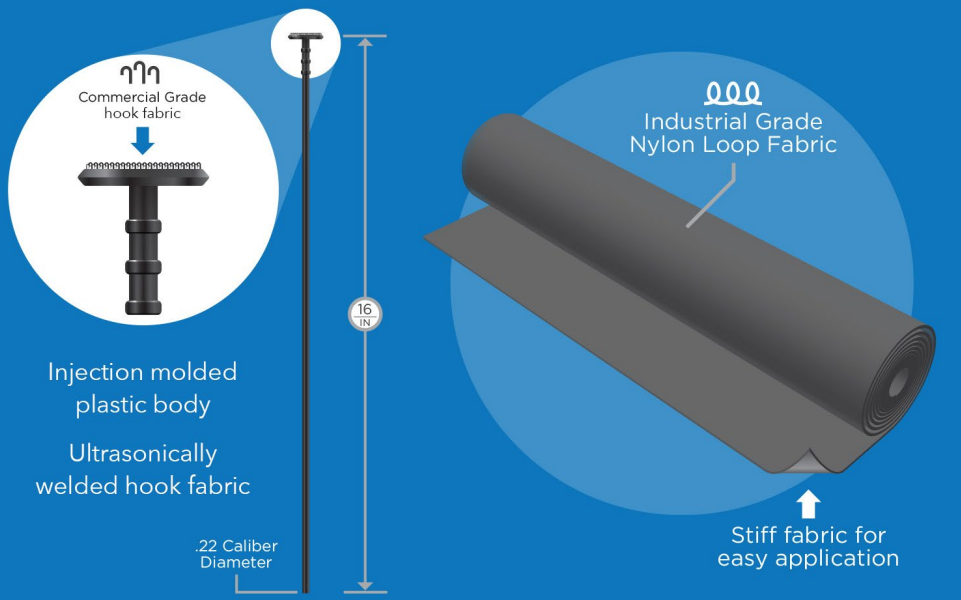

How it Works



REMOVE STANDARD LONG GUN RACKS



ATTACH LOOP FABRIC TO UNDERSIDE OF SHELF

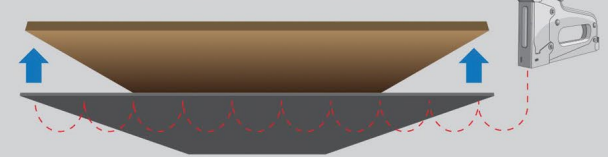

INSERT ROD

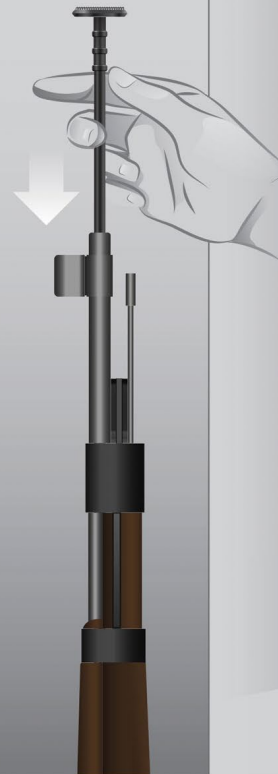

POSITION RIFLES INSIDE GUN SAFE



- AVERAGE 50% MORE GUNS IN SAFE
- WORKS WITH ALL VARIETIES OF LONG GUNS: TACTICAL, COMBINATION, & SHOTGUNS
- EASY ACCESS TO ALL GUNS, EVEN IN BACK ROW

Rifle Rods continued

Gun Safe Accessories

Rifle Rods (con't)

RIFLE ROD KITS



Rifle Rod Kits include Shelf Liner (loop fabric) and Rifle Rods to outfit your gun cabinet with this gun maximizing system. All Rifle Rod Kits include .22 caliber Rifle Rods that fit .22 caliber and larger. Available with Black or Orange Rifle Rods.



SMALL

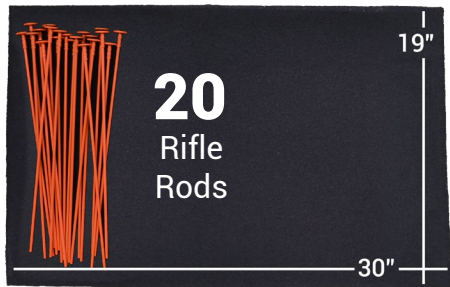

MEDIUM

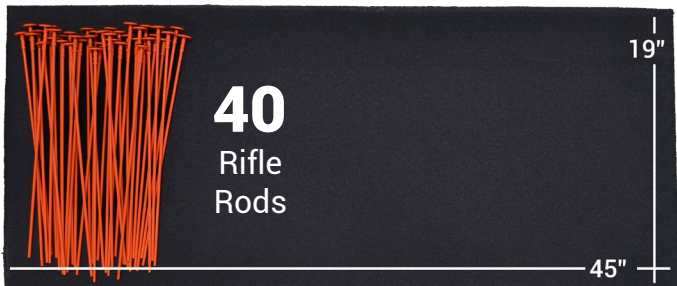

LARGE

Kit Sizes

SMALL

10 Rifle Rods
19" x 15" Shelf Liner

Orange Rods Item# RR10SK-OR
Black Rods Item# RR10SK-BL

MEDIUM

20 Rifle Rods
19" x 30" Shelf Liner

Orange Rods Item# RR20SK-OR
Black Rods Item# RR20SK-BL

LARGE

40 Rifle Rods
19" x 45" Shelf Liner

Orange Rods Item# RR40SK-OR
Black Rods Item# RR40SK-BL

Additional Rifle Rods



Qty. 6

Fits .22 caliber and larger

16" length

Colors:

Orange Rods Item# RR6EXP-OR

Black Rods Item# RR6EXP-BL

NEW! Pink Rods Item# RR6EXP-PK



17 Caliber Rifle Rods



Qty. 2

Fits .17 caliber
and larger

14" length

Color:
Black

Item# RR17CAL

Shelf Liner



Additional Shelf Liner
(as included in Rifle Rod Kits)
Industrial grade 100% nylon woven
loop fabric - will not fray over time.

Sizes:

19" x 15" Item# RRSL-19x15

19" x 30" Item# RRSL-19x30

19" x 60" Item# RRSL-19x60

Stock Support Foam



Stabilize guns in standing position.
Great for guns with a tapered butt.

20" x 30" x 1/2"

Item# FF

ATTACH LOOP FABRIC TO
UNDERSIDE OF SHELF



★★★★★ Great product- room for more guns!!

Using the Rifle Rods helped organize my gun safe and made room (that I didn't know I had) for more guns, which is always a good thing. I was so happy about it I went out and bought a new shotgun!!

8

★★★★★ Force Multiplier

I was able to increase storage within my gun safe by an additional 60% of advertised capacity. I need to keep my firearms secure, but with a gift here and an inherited gun there, I was out of room in the maximum size safe I could locate in my home. Everything is now neat and tidy, and I find I'm not knocking firearms together when removing one from the back.

9

Gun Safe Accessories

Handgun Storage

HANDGUN HANGERS



Handgun Hangers organize the shelves in your safe to store guns more efficiently. There are four styles for storing guns underneath or above the shelf. Slide Handgun Hangers on any standard ($\approx 3/4$ " shelf - no assembly required. Each gun is easy to access and extra space is opened up for more guns!

Fit .22 caliber and larger | Chamfered* & Vinyl coated wire | Adjustable prong

Original Handgun Hangers



Store pistols underneath and to the front of shelf.
4 pack (holds 4 guns)
10" long | Item# HH4

Over-Under Handgun Hangers



Store pistols underneath and above, to the front of shelf.
2 pack (holds 4 guns)
10 1/2" long | Item# OUHH2

Back-Over Handgun Hangers

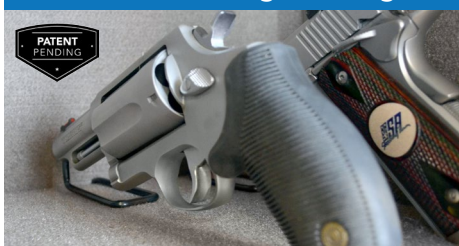

Store pistols above and to the back of shelf.
2 pack (holds 2 guns)
3 1/2" long | Item# BOHH2

Back-Under Handgun Hangers

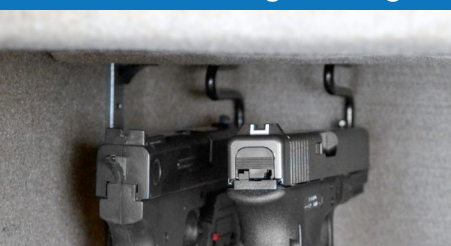

Store pistols underneath and to the back of shelf.
2 pack (holds 2 guns)
4" long | Item# BUHH2

FanStand7



7-gun radial pistol stand. Designed for easy access to each gun, while still having a small footprint on a shelf.

1 pack (holds 7 guns)
16" W x 9.5" D
Item# FANSTAND7

Duelies



Space-saving and easy access double pistol stand.
2 pack (holds 4 guns)
6" L x 4" W | Item# DUEL2

Kikstands



Easy access, individual pistol stand.
2 pack (holds 2 guns)
6" L x 3 3/4" W | Item# KIK2

PRODUCT SPECS



Properties of each Handgun Storage Products

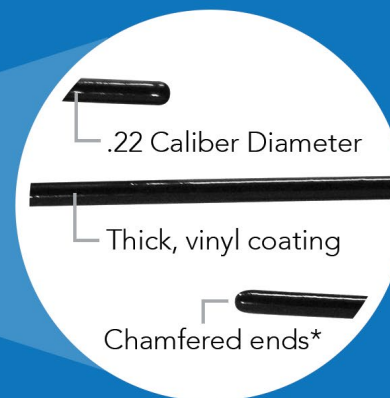

*What does "chamfered ends" mean? The ends of Handgun Hangers are beveled, removing any sharp corners or pieces that may damage the gun.

Gun Safe Accessories

Magazine Storage

MAGMINDER

Qty: 1

Free up shelf space and store magazines under the shelf. This simple, space-saving design creates easy access to your mags. Great for gun safes or any wood shelf.

10" L x 2" W x 2 3/4" H

ITEM# MGMNDR

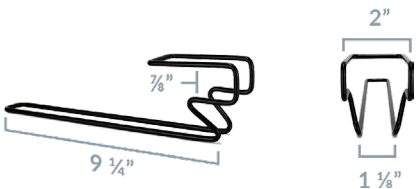

ONE RACK, MULTIPLE USES!

Holds up to 6 double stack magazines



Does not support single stack magazines

Holds up to 3 AR/AK magazines & most PMAGS (with baseplates)



Holds different types of magazines simultaneously



SAFE SAVERS

Qty: 6

Stackable Safe Savers are designed to straddle the anchor bolts in each corner and lift enough for air flow between safe and floor. Can be used to level safe on uneven surfaces. For use with or without bolt kit. Bolt kit not included.

6.5" D x 6" W x 5/16" H

ITEM# SAVER6

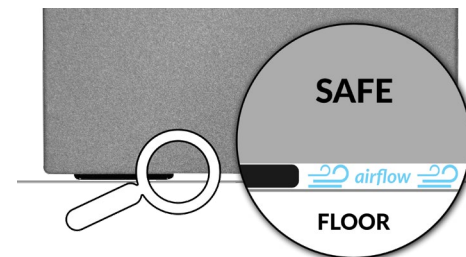

Protect safe and contents from the elements emitted via concrete flooring



Help level safe on uneven surfaces.



Easy to install during bolt-down
Stackable to increase height

EASY INSTALL WITH OR WITHOUT ANCHORS

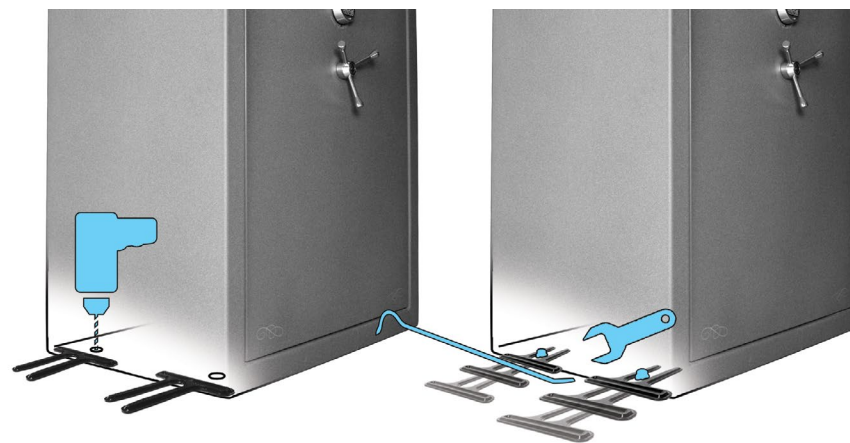

Gun Safe Accessories

Storage Magnets

MULTI-MAGS



Multi-Mags are storage magnets that will hold your pistols and magazines in many different locations.

2 Pack of magnet strips; 4 individual magnets

- Store semi-automatics and magazines under a shelf
- Securely lean rifles against the side of a metal surface
- Fold over and snap together to hold accessories along a metal surface

6 1/2" L x 1" W x 1/2" H

ITEM# MULTMAG2



- Soft-grip rubber coating eliminates marring and scratching.
- Rubber tabs allow for screw or staple gun mounting.
- Easily cut to separate magnet strip into individual magnets
- Will not magnetize gun

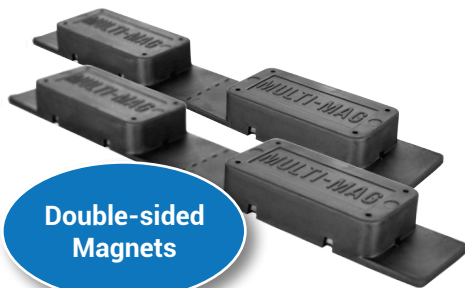
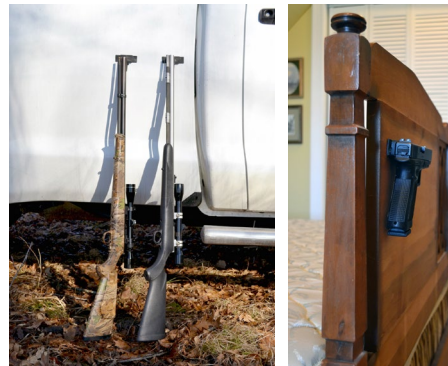

Double-sided Magnets



MULTI-MAGS (con't)

2 Magnets

The two tethered magnets can be kept as one unit for uses like storing a semi-automatic under a shelf. Fold in half to use in tandem with Handgun Hangers or to hold other items.



1 Magnet

Cut the two tethered magnets in half to separate into two individual magnets, which are perfect for two magazines or used as a long gun prop.

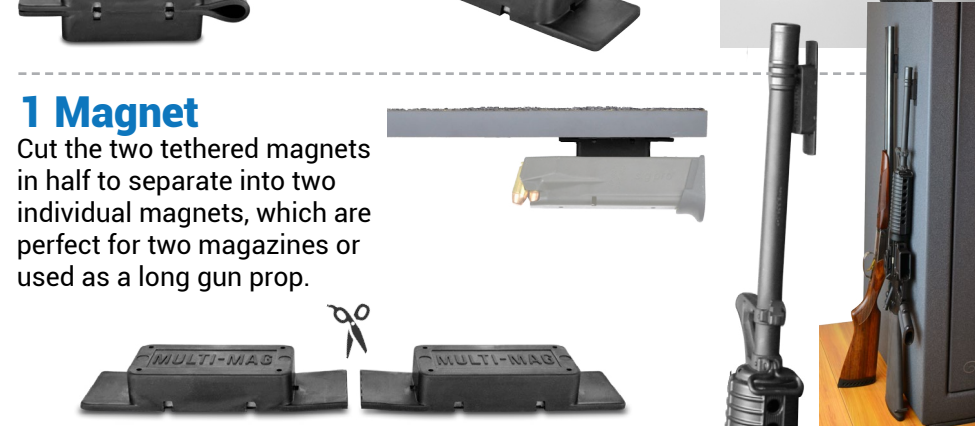

MAG MOUNTS



Organize and store metal magazines on any surface with Mag Mounts. This magnetic strip will adhere to a metal surface with a peel and stick backing or nail to a wooden or drywall surface (nails and tacks provided). Holds metal magazines only.

3" x 10"

ITEM# MAGMNT1

Gun Display Accessories

Pg. 16 - 23

For the Counter



No matter what your application - a gun shop, gun shows or a vault room - our Gun Display Accessories create a great presentation of your firearms.

If you are displaying guns for retail purposes, a great presentation implies expert knowledge and speaks to the quality of your business. When using our Kikstand products, guns will be

For the Wall

easier to access, more will fit on a shelf and the cases will look great even on a busy day.

For a personal gun collection, outfit your man cave or vault room with the same products used in gun shops.

These Gun Display Accessories will adapt to most existing display systems. Made in the USA!



GUN SHOPS



GUN SHOWS

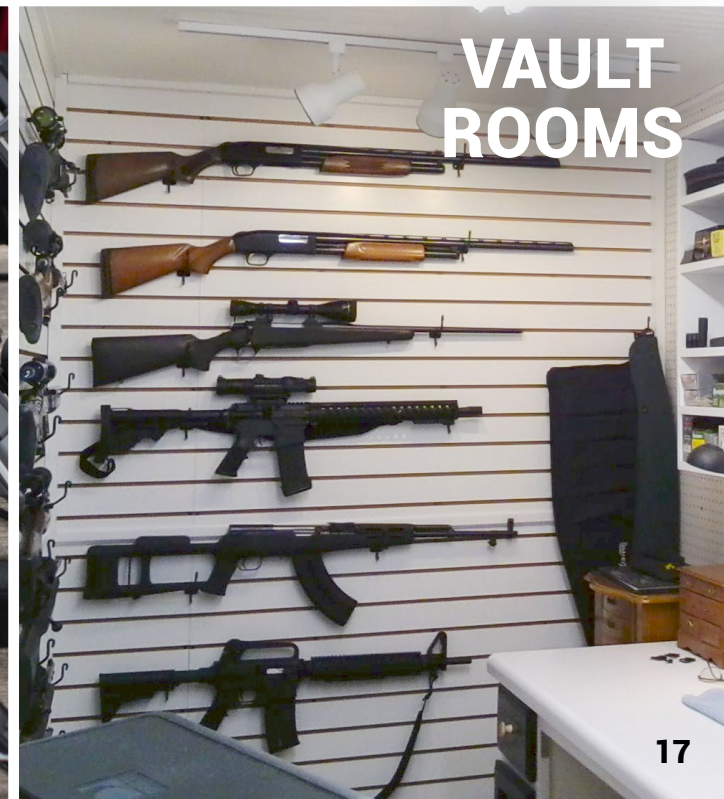

VAULT ROOMS

Gun Display Accessories

For the Shelf

KIKSTAND LINE



Display guns at an angle on a shelf with Kikstands. More guns are able to fit in the same area and are easily accessed by sales associates. Kikstands will insure that every time the gun is taken out of the cabinet it is returned to the same position.

Fit .22 caliber and larger | Chamfered* & Vinyl coated wire | Adjustable prong



Fehner & Son Grain - Gonzales, TX

Front Kiks



Attach to the front of the glass shelf. Front Kiks hold to glass shelving and keep guns closest to the front for best visibility to customers.

10 Pack ITEM# FKIK10



Kikstands



Stand on any flat surface. Great for the bottom shelf of a typical display case. Easy to quickly rearrange guns on a busy day.

10 Pack ITEM# KIK10



Back Kiks



Attach to the back of a glass shelf. Back Kiks hold to glass shelving and keep guns closer to the back of the shelf.

10 Pack ITEM# BKIK10



KIKSTAND TIPS

To display long barreled pistols or rifles, run the prong through the trigger guard. For revolvers, the prong of the Kikstand can be run through the cylinder.



PRODUCT SPECS



Properties of each Handgun Storage Products

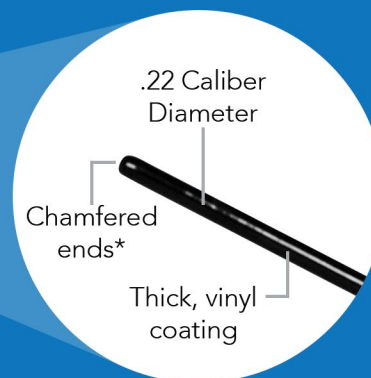

*What does "chamfered ends" mean? The ends of Handgun Hangers are beveled, removing any sharp corners or pieces that may damage the gun.

Gun Display Accessories

For the Shelf (con't)

GUN DISPLAY PRICE TAG SYSTEM

The traditional gun price tags can be replaced with our Gun Display Price Tag System. Gun Display Snaps paired with our Oval Tags give a clean, eye-catching presentation that is easily seen by customers. Snap to the front of Kikstands, Scope Stands and Horizontal Gun Cradles.

Before



After



Aegis Tactical - Lakewood Ranch, FL



Fehner & Son Grain - Gonzales, TX

Gun Display Snaps



Plastic clips to hold price tags on the front of Kikstand products. Includes double stick squares for card application.

10 Pack

ITEM# SNAP10



SCOPE STAND

Works with Scopes, Suppressors and Knives



Display scopes, suppressors, knives and more with this versatile stand. Prevent rolling and rocking to give a clean presentation of inventory or a prized collection.

10 Pack

ITEM# SCOPE10

Gun Display Price Tags



Apply a self printed label or handwrite pricing/gun information. Available in Plastic or Card Stock Paper.

50 Pack

ITEM#
OVLCDR-PLA (Plastic)
OVLCDR-PAP (Paper)



Perfect for use with Avery 5960 Address Labels - Not included.

KIK KLAMPS



Clamp down your Kikstands and Scope Stands to eliminate stands moving around. Two Kik Klamps needed per stand. Hardware not included.

100 per pack

KIK KLMP100

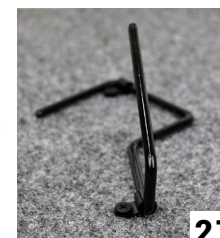

Gun Display Accessories

For the Wall

GUN CRADLES

Secure long guns horizontally or vertically along a slatwall, pegboard or gridwall using Gun Cradles. Thick vinyl coating. Compatible with our Gun Display Price Tag System. Simple, non-obtrusive design keeps the gun as the focal point.

Horizontal Gun Cradles

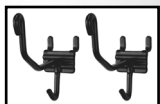

Slatwall / Pegboard

Fits standard particle board slatwall and 1" pegboard. Vinyl coated.

10 pack (holds 5 guns)
Item# SLAT-GCRDL10

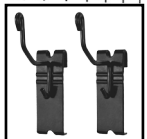

Gridwall

Fits standard 3" gridwall. Vinyl coated.

10 pack (holds 5 guns)
Item# GRID-GCRDL10

Vertical Gun Cradles



Fits standard slatwall or 1" pegboard display. Vinyl coated.

10 pack (holds 10 guns)
Item# SLAT VERT10



Contact us for a free sample to check compatibility with your display wall!

GUN ROOM

GUN SHOP



SNIPERS

*Works with most particle board slatwall



Display pistols along slatwall. Simple, clean design disappears when mounted, keeping the focus on the gun. Chamfered (or beveled) ends with a thick vinyl coating. Fits .22 caliber and larger. Fits standard particle board slatwall.

Left-hand pull

10 pack (holds 10 guns)
Item# SNPR10LT



Right-hand pull

10 pack (holds 10 guns)
Item# SNPR10RT



Before & After Pictures

We love getting Before & After pictures from our customers! If you are purchasing in preparation for a big gun organization project, please snap a "before" picture. Once you have reorganized with Gun Storage Solutions products, snap an "after" picture. To see others who have done this, please visit the Customer Testimonial page on our website. To give you some examples, here are a few of our favorites...

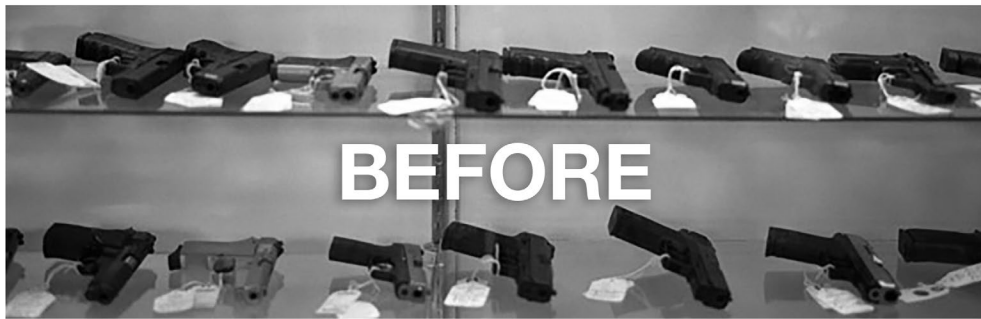

About Us

Our mission is to help you develop a safe, usable, maximized storage space for your gun collection.

Gun Storage Solutions creates products that will efficiently store and display firearms and accessories. With versatility as a priority, these products will retrofit any space – gun safes, display cabinets or vault rooms. Utilizing wasted space, the products from Gun Storage Solutions make even the smallest space store more guns. Imagine your gun storage space with more guns, easier accessibility and functionality.

Gun Storage Solutions wants to give you the best storage space for your guns that is practical for your life and collection. We are a family company with products designed, manufactured and packaged in the United States.



**Gun Shops - Contact us
about our Dealer Program!**
info@storemoreguns.com



Shop our website
www.GunStorageSolutions.com



Call to place an order
855-647-8673

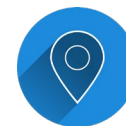

Find a dealer in your area
Search the locator map on our website.



**GUN STORAGE
SOLUTIONS**

www.GunStorageSolutions.com

3001 Gill Street, Bloomington, IL 61704

p: 855-647-8673 | f: 855-647-8273

info@storemoreguns.com

