

BFX

American Security



TABLE OF CONTENTS

BFX Series

120 Min. Fire U.L. Level I Burglary **4**

BFII Series

120 Min. Fire U.L. Level II Burglary **8**

RF Series

120 Min. Fire U.L. Listed High Security **11**

NF Series

90-Minute Fire U.L. Level I Burglary **12**

SF Series

60-Minute Fire **13**

TF Series

30-Minute Fire **14**

Defense Vault

. **15**

AM Series

. **16**

Handgun Safes

. **17**

Compact Safes

. **18**

Vault Doors

. **19**

Storage Options

. **20**

Safe Cloak

. **20**

Electronic Locks & Other Options

. **21**

Features At A Glance

. **22**

On the Cover:

*BFX6030L in NEW Burnt Orange with
Black Nickel Hardware and Optional Finials.*



WE STAND BEHIND OUR CRAFTSMANSHIP WITH A "NO COST" LIFETIME WARRANTY AGAINST THEFT & FIRE

American Security Products manufactures safes with the best fire and burglary protection in the industry. We're so confident in our products, that we offer a lifetime warranty on all our gun safes. Our warranty covers:

- Burglaries – If your safe is forcibly entered, we will repair or replace it free of charge.
- Attempted Burglaries – If your safe undergoes a drill, punch or pry attack and is not breached, we will repair or replace it free of charge.
- Damage from a Home Fire – If your safe is damaged in a home fire, we will repair or replace it free of charge.

At no cost to you, we will either repair your damaged gun safe or replace it with a current production model of comparable value.¹



Intertek

STANDARDIZED TESTING FROM INDEPENDENT LABORATORIES

AMSEC is one of the first manufacturers in the gun safe industry to use standardized test procedures from independent laboratories to substantiate our burglary and fire ratings. Standardized independent testing provides consistent test procedures that can be used across the industry so consumers can meaningfully compare ratings between different safes when making a purchasing decision.

BURGLARY RATINGS

In the United States, the most recognized testing organization for burglary resistance of safes is Underwriters Laboratories (UL). UL publishes standards and administers tests to check if products meet those standards. Standards include specific tools that are used during a break-in attempt and a specific time limit for the test. There are several different burglary classifications that establish specific levels of attack resistance. The most common listing in the gun safe industry is Residential Security Container (RSC).

FIRE RATINGS

The ETL logo on our fire-rating labels indicates that our ratings have been verified by independent testing at Intertek Laboratories. Intertek is a multinational independent inspection, product testing and certification organization with over 38,000 employees in over 100 countries. To test our products, Intertek places our safes in a furnace with 8 gas burners. The test furnaces reach 1200°F in 8 minutes. That temperature is maintained for the duration of the test. Five separate thermocouples monitor the temperature inside the safe. To pass Intertek's test, the internal temperature inside a safe must remain below 350°F. Paper burns at approximately 450°F.

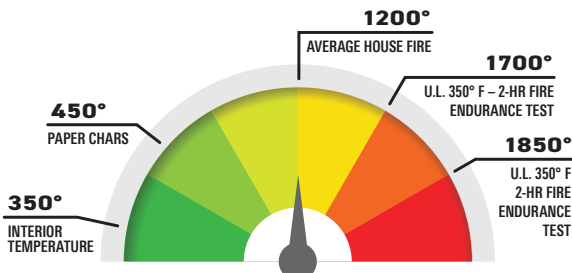

Series	Fire Label	Outside Temp	Time Period	Inside Temp Less Than
RF Series	120	1850°F	120 min.	350°F
BFII / BFX Series	ETL 120	1200°F	120 min.	350°F
NF Series	ETL 90	1200°F	90 min.	350°F
SF Series	ETL 60	1200°F	60 min.	350°F
TF Series	30	1200°F	30 min.	350°F

¹ To file a claim, you must be the original owner of the AMSEC Gun Safe. Within 30 days of the burglary/fire incident, you must properly file a police report documenting the incident. A copy of the police report must be submitted to AMSEC with your warranty claim.

BFX SERIES - 120 MINUTE FIRE



BFX6030L
Shown in NEW Burnt Orange
with Black Nickel hardware
left swing with optional finials

SECURITY

- ½"-Thick Steel Plate Door (BFX7250 & BFX6024 have 3/8" steel plate)
- Four-Way Active Bolt Work (BFX6024 has Two-Way Bolt Work)
- Active 4x Locking System (See Page 6 for Details)
- 2"-Thick Body
- UL Level I RSC Burglary Classification
- Massive 1½" Chrome Plated Bolts
- Anchor Holes Provided

WARRANTY

- 5-year parts and labor warranty when purchased with a factory installed AMSEC lock.
- Special lifetime warranty for damage from burglary attempts and fire.

FIRE PROTECTION

- Seamless DryLight Fill
- 120-Minute Intertek Verified Fire Rating
- Dual Door Seals to Protect Against Fire and Smoke

FUNCTIONALITY

- Industry's Most Flexible Interior
- Door Organizer
- Storage for up to Two Long Guns on Door
- Spy-proof, key-locking dial with decorative five-spoke handle and a convenient pull handle. (BFX6024 offers a three-spoke handle and does not come with a pull handle).
- Mirrored Back Wall for Added Interior Visibility
- AC Power Outlet with Removable Cord
- LED Light Kit

U.L. LISTED LEVEL I BURGLARY SAFE

BFX SERIES CONSTRUCTION

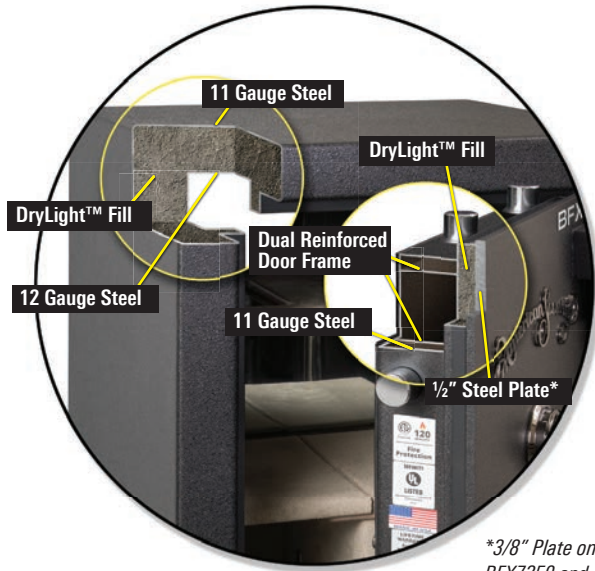

**3/8" Plate on
BFX7250 and BFX6024*

**BFX GUN SAFES:
11 GA OUTER STEEL LINER WITH
12GA INNER STEEL LINER
TOTALING APPROX 1/4" STEEL BARRIER**



BFX6636
Shown in Sapphire Blue



BFX SPECIFICATIONS

Model	Outside Dim H x W x D	Interior Capacity	Weight Lbs.
BFX7250	71-1/4" x 50" x 28"	14-14-14-28-42 + 2 Gun or 73 + 2 Gun	1,851
BFX7240	71-1/4" x 40" x 26"	12-12-12-24-36 + 2 Gun or 58 + 2 Gun	1,647
BFX6636	65-1/4" x 36" x 26"	12-12-24 + 2 Gun	1,375
BFX6030	59-1/4" x 30" x 26"	11-11-22 + 2 Gun	1,081
BFX6032	59-1/4" x 30" x 21"	9-9-18 + 2 Gun	958
BFX6024	59-1/4" x 24" x 21"	8-8-16 Gun + 1 Gun	751

BFX SERIES ACTIVE 4X

LOCKING SYSTEM

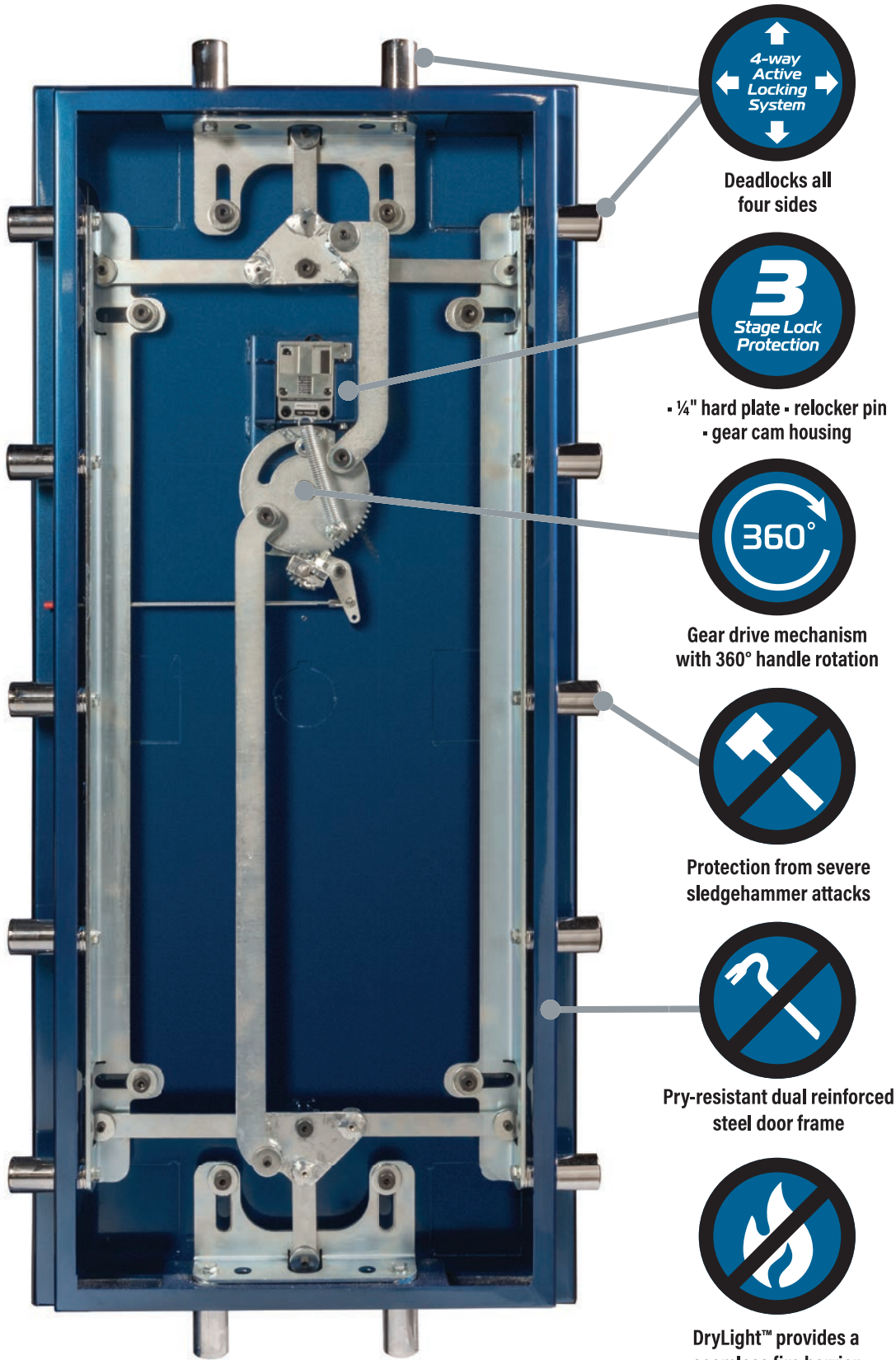

Deadlocks all four sides



• 1/4" hard plate - relocker pin
• gear cam housing



Gear drive mechanism with 360° handle rotation

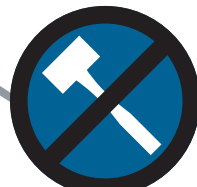

Protection from severe sledgehammer attacks



Pry-resistant dual reinforced steel door frame



DryLight™ provides a seamless fire barrier

BUILT WITH UNBEATABLE SECURITY FEATURES THAT KEEP BURGLARS OUT!



DRILL ATTACK PROTECTION

- 1/4" hardplate and a top-rated hardened disc defeats lock attack's
- Spring loaded relock mechanism
- Gear cam housing with precision engineered lock bolt protection

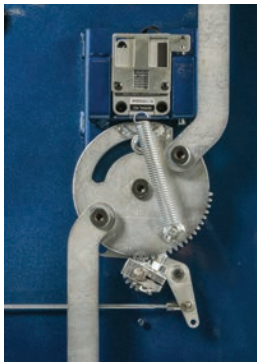
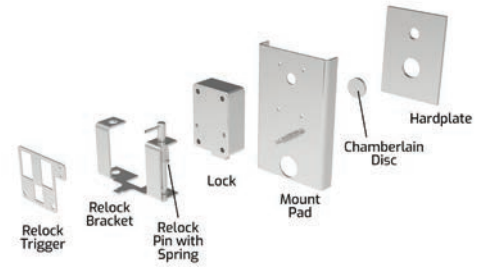

GEAR-DRIVEN BOLTWORK WITH 360° HANDLE ROTATION

Drives the industry's longest solid steel locking bolts deep into the body of the safe protecting the safe against severe pry attacks.



SLEDGEHAMMER IMPACT-RESISTANT BOLTWORK

Protects the heart of the Active 4x locking mechanism from severe sledgehammer attacks.



PRY-RESISTANT DUAL REINFORCED STEEL DOOR FRAME

Protects the heart of the Active 4x locking mechanism from severe pry attacks.

BFII SERIES - 120 MINUTE FIRE

U.L. LISTED LEVEL II BURGLARY

BFII SERIES CONSTRUCTION



BFII7250

Shown in Textured Black with Chrome Hardware and optional finials

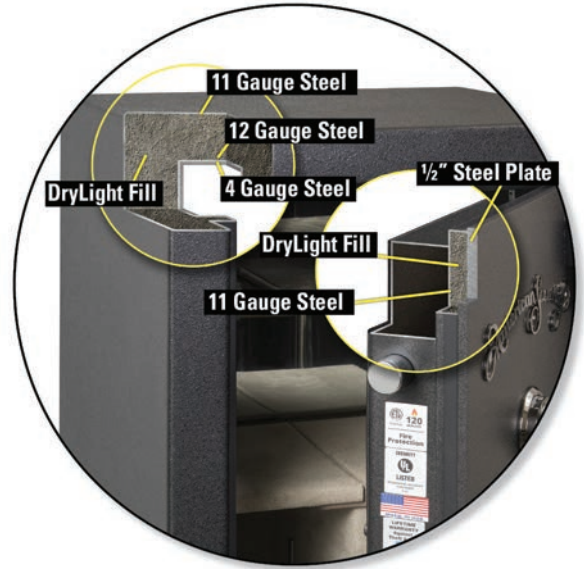

BFII GUN SAFES:

11GA OUTER STEEL LINER WITH A COMBINED 5/16" INNER STEEL LINER PROVIDING A TOTAL 1/2" THICK STEEL BARRIER FOR ADDED BURGLARY PROTECTION



SECURITY

- 1/2" solid steel plate door
- 2 1/4"-Thick Body with 1/8" outer shell and 5/16" thick inner liner
- Combined steel thickness of 1/2" in body construction
- UL Level II RSC Burglary Classification (2-Man team, 10-minute test. Utilizes same tools as a TL-15)
- AMSEC's Patented Active Hardplate
- TL-15 boltwork with 10 massive 1 1/2" Chrome Plated Bolts
- Anchor Holes Provided

WARRANTY

- 5-year parts and labor warranty when purchased with a factory installed AMSEC lock.
- Special lifetime warranty for damage from burglary attempts and fire.

FIRE PROTECTION

- Seamless DryLight Fill
- 120-Minute Intertek Verified Fire Rating
- Dual Door Seals to Protect Against Fire and Smoke

FUNCTIONALITY

- Industry's Most Flexible Interior
- Door Organizer
- Storage for Long Guns on Door
- Spy-proof, key-locking dial with decorative five-spoke handle and a convenient pull handle. (BFII6024 offers an "L" handle and does not come with a pull handle).
- Mirrored Back Wall for Added Interior Visibility
- AC Power Outlet with Removable Cord
- LED Light Kit

BFII SPECIFICATIONS

Model	Outside Dim H x W x D	Interior Capacity	Weight Lbs.
BFII7250	71-1/4" x 50" x 28"	14-14-14-28-42 + 2 Gun or 73 + 2 Gun	2,438
BFII7240	71-1/4" x 40" x 26"	12-12-12-24-36 + 2 Gun or 58 + 2 Gun	1,991
BFII6636	65-1/4" x 36" x 26"	12-12-24 + 2 Gun	1,716
BFII6030	59-1/4" x 30" x 26"	11-11-22 + 2 Gun	1,395
BFII6032	59-1/4" x 30" x 21"	9-9-18 + 2 Gun	1,244
BFII6024	59-1/4" x 24" x 21"	8-8-16 Gun + 1 Gun	1,067

BFII AND BFX SERIES

WHAT IS DRYLIGHT?



The American Security Products BF Gun Safes are the best gun safe available today. For burglary protection, it has a massive 1/2"-thick steel plate in the door. For fire protection, it is filled with our revolutionary DryLight.

For many years, smaller fire safes have been constructed with a poured fill material. But larger gun safes pose several manufacturing challenges when it comes time to fill them with insulating materials. Because of this, the industry adopted the use of drywall as the primary material for fire protection. The problem with using drywall is that no matter how much care is taken in assembling the many pieces of drywall into the safe body, gaps and joints still remain in the construction that can allow heat to penetrate the safe body. AMSEC was able to overcome this technical challenge by developing manufacturing processes that allow us to produce a safe body filled with the seamless DryLight fire barrier. Independent testing at Intertek Laboratories has confirmed that these safes outperform gun safe bodies constructed with drywall.

BFX/BFII BURGLARY RATINGS COMPARISON

BFX Gun Safes - RSC Level I (1-Man, 5 minute test. Utilizes tools typically found in a household)	BFII Gun Safes - RSC Level II (2-man Team, 10 minute test. Utilizes same tools as a TL-15 test)
1/4" Dia Punch	1/2" Dia Punch
Sledge Hammer 3 lb	Sledge Hammer 10 lb
Crow Bar, 18"	Pry Bar, 6 ft
Chisel 1/2"	Chisel 1" Wide x 12" L
Screw Driver 18	Screw Driver 18
1/4" Drill Bits	1/2" Drill Bits
3/8" Drill	1/2" HD Drill
	Pick, 30"
	Axe, 35"
	4" Conic Punch
	Hole Saw, 3" Carbide
	Pin Hammer
	Wedge, Log Splitting
	Punch/Chisel Holder

RSC LEVEL I TOOL COMPLEMENT



RSC LEVEL II TOOL COMPLEMENT



BFII AND BFX SERIES

COLOR AND INTERIOR OPTIONS



BFX6636

Shown above in Saphire Blue with Chrome hardware, new barrel hinge with optional decorative finials and optional ESL10XL electronic lock



BFX6032

Shown in Pearl Essence with Black Nickel hardware and optional decorative finials



BFX6024

Shown in Textured Black

HIGH-GLOSS COLORS



Platinum Metallic



Burnt Orange



Onyx



Charcoal Metallic



Rosso Corsa Red



Pearl Essence



Sapphire Blue

TEXTURED COLORS



Sandstone

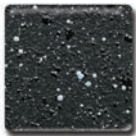

Granite



Black



Chocolate Brown

TWO-TONE COLORS



Black/Onyx

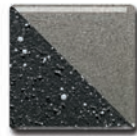

Granite/Charcoal

HARDWARE COLORS



Chrome

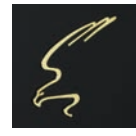

Brass



Black Nickel

BFII/BFX SERIES INTERIOR CONFIGURATIONS:

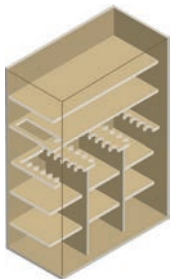

7250 Standard Gun Interior



7250 Optional 73 Gun Interior

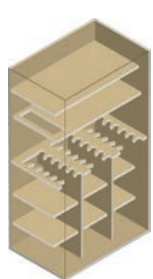

7240 Standard Gun Interior



7240 Optional 58 Gun Interior

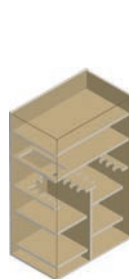

6636 Standard Gun Interior

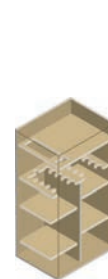

6030 Standard Gun Interior



6032 Standard Gun Interior



6024 Standard Gun Interior

RF SERIES - 120 MINUTE FIRE

U.L. LISTED HIGH SECURITY

AMSEC offers the only gun safes that have a TL - 30 and TL - 30x6 Six-Sided UL Burglary Rating. To earn a TL - 30 or TL - 30x6 UL Burglary Rating, these safes are subjected to a brutal 30-minute attack by trained technicians using tools such as sledge hammers, picks, chisels, circular saws, carbide drills, wedges, and pry bars. These safes represent the industry standard for protecting high value assets against the threat of serious attack.

The high level of security of these safe comes from AMSEC's unique composite construction. High-strength concrete with proprietary aggregate combined with a matrix of formed steel barriers stop all types of attacks outlined in the Underwriters Laboratories standard. These massive safes weigh between 3,400 and 4,500 pounds. No one is walking out of your house with one of these.

This is the same commercial safe construction that AMSEC sells to banks and jewelers across the county. Today there are hundreds of millions of dollars in assets protected by AMSEC High-Security Composite Safes.

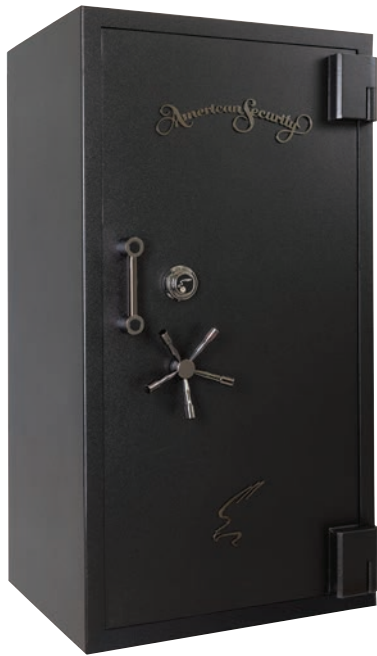

RF582820X6

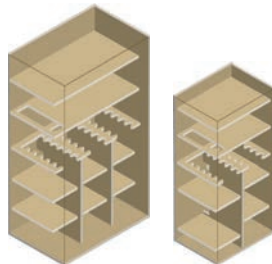

RF703620X6 Interior

RF582820X6 Interior



RF6528



RF6528 Interior

Model	Outside Dim H x W x D	Interior Capacity	Weight Lbs.
RF703620X6	76" x 42" x 29¼"	12-12-12-24-36 Gun +2 Gun or 58 + 2 Gun	4,578
RF582820X6	64" x 34" x 29¼"	12-12-24 Gun + 2 Gun	3,418
RF6528	72" x 35" x 29½"	12-12-24 Gun + 2 Gun	3,455

SECURITY

- 6" Thick High Security Composite Door
- 3½" Thick High Security Body (3" on X6)
- UL Listed TL - 30 or TL - 30X6 High Security Burglary Classification
- 10 Massive 1½" Chrome Plated Bolts
- Anchor Holes Provided

FIRE PROTECTION

- Seamless High Security Composite Fill
- 120-Minute Fire Rating
- Palusol Door Seal Protects Against Fire and Smoke

FUNCTIONALITY

- Industry's Most Flexible Interior
- Door Organizer
- Storage for Two Long Guns on Door
- 3 Outlet power strip with USB ports
- LED Light Kit



HIGH-GLOSS COLORS (AVAILABLE ON RF6528 ONLY)



TEXTURED COLORS (ALL MODELS)

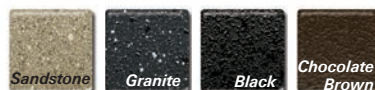

HARDWARE COLORS

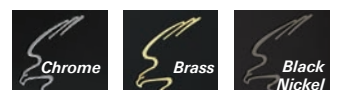

NF SERIES - 90 MINUTE FIRE

U.L. LISTED LEVEL I BURGLARY

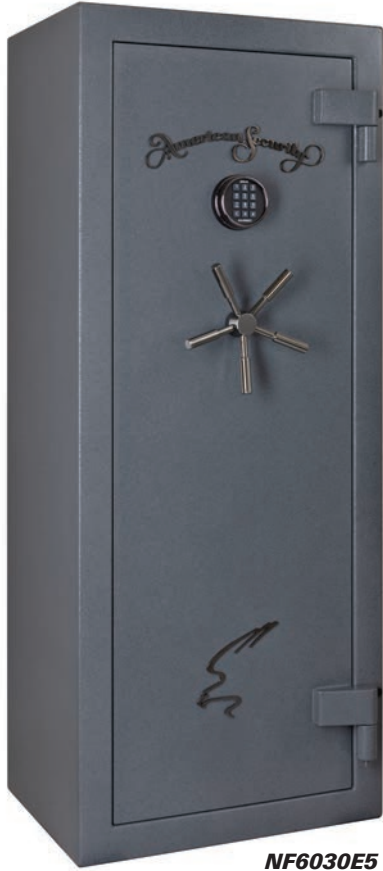

The American Security Products NF Gun Safe offers both superior performance and value. For burglary protection, it has a stout 1/4"-thick steel plate door. For fire protection, it is lined with 3 to 4 layers of drywall that are strategically engineered for optimal fire protection. This enables the NF Gun Safe to pass a verified 90-minute fire test at Intertek, an independent testing laboratory.

SECURITY

- 1/4"-Thick Steel Plate Door
- Four-Way Bolt Work
- 11-Gauge Steel Body
- UL Level I RSC Burglary Classification (1-Man, 5-minute test. Utilizes tools typically found in a household)
- 14 Massive 1 1/2" Chrome Plated Bolts
- Anchor Holes Provided
- U.L. Listed ESL5 Electronic Lock with Illuminated Keypad

FIRE PROTECTION

- Lined with Three Layers of Drywall
- 90-Minute Intertek Verified Fire Rating
- Dual Door Seals to Protect Against Fire and Smoke

FUNCTIONALITY

- Industry's Most Flexible Interior
- Door Organizer
- Storage for up to Two Long Guns on Door
- AC Power Outlet

NF SERIES CONSTRUCTION

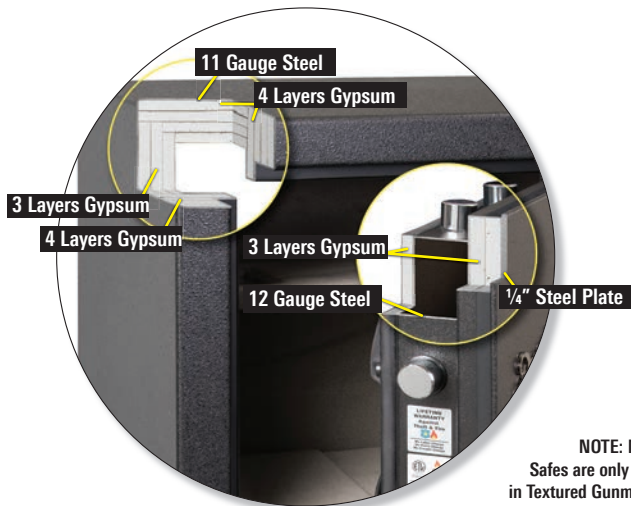

NOTE: NF Series Safes are only available in Textured Gunmetal with Black Nickel Hardware



COLOR & HARDWARE

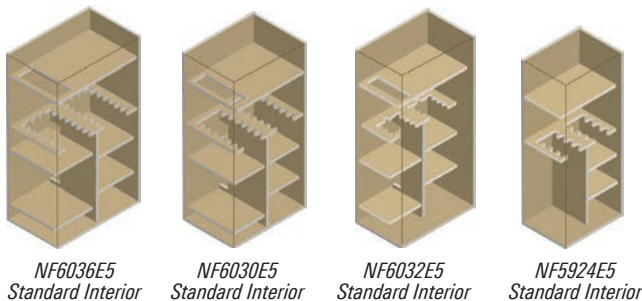

Model	Outside Dim H x W x D	Interior Capacity	Weight Lbs.
NF6036E5	59" x 36" x 26"	17-17-34 + 2 Gun	977
NF6030E5	59" x 30" x 26"	14-14-28 + 2 Gun	854
NF6032E5	59" x 30" x 21"	9-9-18 + 2 Gun	761
NF5924E5	59" x 24" x 18"	8-8-16 Gun + 1 Gun	600

SF SERIES - 60 MINUTE FIRE



SF6032E5

The American Security Products SF gun safe offers both performance and value. For burglary protection, it has a stout 3/16" - thick steel plate door. For fire protection, it is lined with 3 to 4 layers of drywall that are strategically engineered for optimal fire protection. This enables the SF Gun Safe to pass a verified 60-minute fire test at Intertek, an independent testing laboratory.

SECURITY

- 3/16"-Thick Steel Plate Door
- Four-Way Bolt Work
- 12-Gauge steel body
- 14 1 1/4" Chrome Plated Bolts
- Anchor Holes Provided
- U.L. Listed ESL5 Electronic Lock with Illuminated Keypad

FIRE PROTECTION

- Lined with three layers of drywall
- 60-Minute Intertek Verified Fire Rating
- Dual Door Seals to Protect Against Fire and Smoke

FUNCTIONALITY

- Industry's Most Flexible Interior
- Door Organizer
- Storage for up to Two Long Guns on Door

SF SERIES CONSTRUCTION

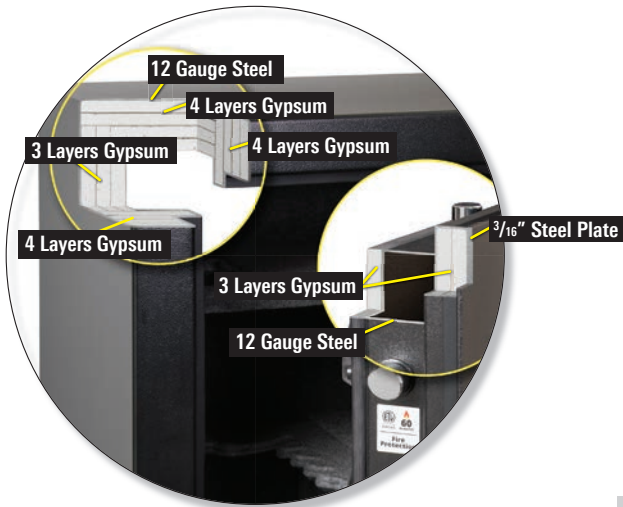

SF6036E5

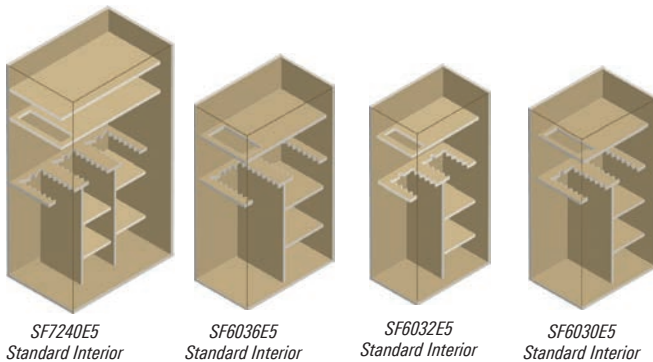

COLOR & HARDWARE



Black



Black Nickel

NOTE: SF Series Safes are only available in Textured Black with Black Nickel Hardware



Model	Outside Dim H x W x D	Interior Capacity	Weight Lbs.
SF7240E5	72" x 40" x 26"	15-15-15-30-45 + 2 Gun	1,007
SF6036E5	59" x 36" x 26"	17-17-34 + 2 Gun	834
SF6030E5	59" x 30" x 26"	15-15-30 + 2 Gun	740
SF6032E5	59" x 30" x 21"	11-11-22 + 2 Gun	662

TF SERIES

30 MINUTE FIRE

The American Security Products TF Gun Safe offers economic trusted protection. For burglary protection, it has a stout 3/16"-thick steel plate door. For fire protection, it is lined with drywall that is strategically engineered for 30 minutes of fire protection.



TF5924E5



TF5517E5



SECURITY

- 3/16"-Thick Steel Plate Door
- Four-Way Bolt Work
- 14-Gauge Steel Body
- 14 1/4" Chrome Plated Bolts on TF5924E5
- 8 1" Chrome Plated Bolts on TF5517E5
- Anchor Holes Provided
- U.L. Listed ESL5 Electronic Lock with Illuminated Keypad

FUNCTIONALITY

- Industry's Most Flexible Interior
- Door Organizer
- TF5924 has Storage for One Long Gun on the Door

TF SERIES CONSTRUCTION

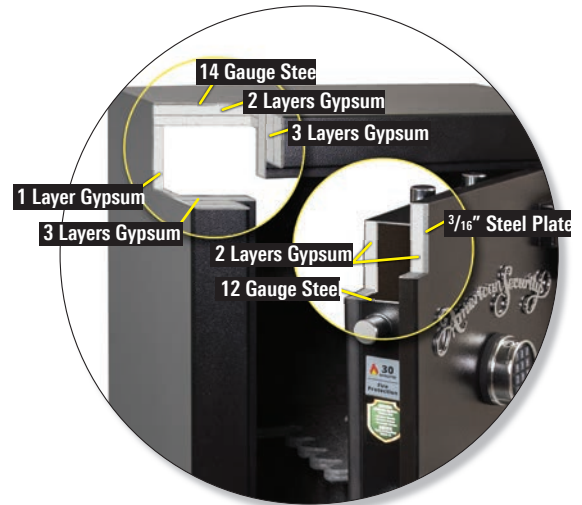

FIRE PROTECTION

- Lined with Two Layers of Drywall on the Ceiling and Door
- Lined with One Layer of Drywall in All the Walls
- 30-Minute Factory Label
- Dual Door Seals to Protect Against Fire and Smoke



TF5924E5 Standard Gun Interior



TF5517E5 Standard Gun Interior



Model	Outside Dim H x W x D	Interior Capacity	Weight Lbs.
TF5924E5	59" x 24" x 18"	8-8-16 Gun + 1 Gun	388
TF5517E5	55-1/4" x 17-3/4" x 16"	11 Gun	286

COLOR & HARDWARE



Black



Black Nickel

NOTE: TF Series Safes are only available in Textured Black with Black Nickel Hardware



DEFENSE VAULT

PUTS HOME SECURITY
WHERE YOU NEED IT



*Features the U.L. Listed
ESL5 Illuminated
Electronic Lock*



AMSEC's DV652 was produced from our culture of listening to customers. Customers wanted a secure place to store their home defense weapons. They wanted something that could be kept in their bedrooms, close to their bed. After days of brainstorming, the DV652 was born. Sleek enough to fit under most beds, the DV652 can be secured to either the floor or the bed and is equipped with our backlit ESL5 lock, which offers a silent stealth-mode option and was specifically designed for this product.

FEATURES

- Slide-Out Drawer
- Backlit U.L. Listed ESL5 Electronic Lock
- 14-Gauge Steel Construction
- 5-Point Locking Bar
- 4 Mounting Holes on Both the Top and Bottom

Model	Outside Dimension	Tray Size	Wt. Lbs.	Locking Device	Warranty
DV652	6" x 52" x 14"	3 ³ / ₈ " x 43 ¹ / ₄ " x 13"	90	5-Point Slide Locking Bar with ESL5 Electronic Lock	1 Year Parts & Labor



Shown above: AM4020E5

AM SERIES HOME SAFES



AM3020E5



FEATURES:

- Powder-Coated Blue with Black Nickel Hardware
- Gray Fabric Interior
- Backlit U.L. Listed ESL5 Electronic Lock
- 12-Gauge Steel Body
- Drywall Lined
- 45-Minute ETL Verified Fire Rating
- Three-Way Bolt Work
- Electrical Access Hole
- 4 Pre-Cut Anchor Holes
- 1 Year Parts and Labor Warranty

Model	Outside Dimensions	Inside Dimensions	Cu. In.	Wt. Lbs.	Shelves
AM2020E5	17-1/4" x 17-1/4" x 14"	20" x 20" x 20"	4,166	180	1
AM3020E5	27-1/4" x 17-1/4" x 14"	30" x 20" x 20"	6,581	230	2
AM4020E5	37-1/4" x 17-1/4" x 14"	40" x 20" x 20"	8,996	282	3

HANDGUN SAFES



	PS1210HD	PS1208EZ	HAS410
Type	Portable	Portable	Hide-a-Safe
Exterior Dimension	10 1/4" x 12 1/2" x 4 1/4"	8 1/8" x 12 1/4" x 4"	12" x 10" x 4"
Weight	24 Lbs.	11 Lbs.	20 Lbs.
Body	10 ga. Solid Steel	14 ga. Solid Steel	10 ga. Solid Steel
Door	3/16" Solid Steel	14 ga. Solid Steel	3/16" Solid Steel
Lock	Simplex Mechanical Push Button	Simplex Mechanical Push Button	Simplex Mechanical Push Button
Locking Bolt	1 1/2" x 1/2" Solid Steel Block	1 1/2" x 1/2" Solid Steel Block	1 1/2" x 1/2" Solid Steel Block
Lock Protection	Solid Steel Lock Housing	Solid Steel Lock Housing	Solid Steel Lock Housing
Interior	High Density Pluck Foam	High Density Pluck Foam	High Density Pluck Foam
Finish	Granite Textured	Charcoal Gray	Granite Textured
Carry Handle	Chrome Plated Collapsible	Chrome Plated Collapsible	Solid Steel Fixed
Anchor Holes	4	4	4 (Top & Bottom)
Origin	China	China	China





FIRE SAFES

THE ONLY UL-RATED 1-HOUR IMPORTED RESIDENTIAL FIRE SAFES WITH HIGH SECURITY, BOUNCE-RESISTANT LOCKS

Amsec 1-Hour Fire Safes are the only UL listed 1-hour fire safe offering a UL listed electronic lock. These locks offer far greater security than the locks offered on any other 1-hour fire safe.



FS914E5LP



FS149E5LP



FS914



FS149



FS1814E5

FEATURES:

- UL 350°F 1-Hour Fire Rating
- UL Listed Type 1 Electronic Lock
- Mechanical Combination Lock with Key Activated Boltwork on FS914 & FS149
- Backlit Keypad
- Black Granite Textured Finish
- 1 Year Parts and Labor Warranty

Model	Interior Dimensions	Exterior Dimensions	Clear Door	Cu. In.	Wt. Lbs.
FS914E5LP	9-3/4 x 15-1/4 x 9-7/8	14 x 19-1/2 x 15-3/8	9-3/4 x 15-1/4	1,438	96
FS149E5LP	15-1/4 x 9-3/4 x 9-7/8	19-1/2 x 14 x 15-3/8	15-1/4 x 9-3/4	1,468	96
FS914	9-3/4 x 15-1/4 x 9-7/8	14 x 19-1/2 x 15-3/8	9-3/4 x 15-1/4	1,438	96
FS149	15-1/4 x 9-3/4 x 9-7/8	19-1/2 x 14 x 15-3/8	15-1/4 x 9-3/4	1,468	96
FS1814E5	18-1/4 x 13-1/8 x 12-3/8	23-3/4 x 18-7/8 x 18-1/2	18-1/4 x 13-1/8	2,964	164

ELECTRONIC SAFES

WITH DL6000 ELECTRONIC LOCK



EST813



EST1014



EST916



EST2014

FEATURES:

- 14-Gauge Steel Body
- DL6000 Electronic Lock
- LCD Display
- Pry-Resistant Recessed Door
- Internal Hinges
- 1 Year Parts and Labor Warranty
- Bounce-Resistant Lock Design

Model	Interior Dimensions	Exterior Dimensions	Clear Door	Cu. In.	Wt. Lbs.
EST813	7-1/16 x 12 1/16 x 5-3/8	7-7/8 x 12-1/4 x 8	5-3/4 x 8-1/4	499	16
EST916	8-13/16 x 15-13/16 x 11-1/8	9 x 16 x 13-1/4	6-3/4 x 12-1/8	1,550	27
EST1014	9-9/16 x 13-15/16 x 7-3/4	9-3/4 x 14-1/8 x 9-3/4	7-5/8 x 10-1/4	1,032	22
EST2014	19-9/16 x 13-9/16 x 10	19-3/4 x 13-3/4 x 12-1/4	17-1/8 x 9-1/4	2,602	40

TURN YOUR ENTIRE ROOM INTO A SECURITY VAULT

AMSEC Vault Doors offer the same protection as our innovative BF Gun Safes. They are designed to fit standard 80" x 30" and 80" x 36" door openings. With our inward-swinging vault door option, your vault room can also serve as a storm shelter. The vault door's inward swing ensures that you will be able to open the door even if debris has fallen on the other side. All AMSEC vault doors can be opened from the inside, ensuring personal safety.

STANDARD FEATURES

- 2" Thick Door
- 10 1/2" Chrome Plated Bolts (5 bolts on inswing doors)
- Adjustable Frame to Fit Walls Ranging From 4 3/4" to 9 1/2" Thick
- Safety Lock Release
- Spy-proof, key-locking dial with decorative five-spoke handle and a convenient pull handle.
- 1 Year Parts and Labor Warranty

BF SERIES VAULT DOOR FEATURES

- 1/2" Steel Plate on Face of Door
- 1 3/8" of Seamless Drylight as Fire Protection

BFQ SERIES VAULT DOOR FEATURES

- 1/4" Steel Plate on Face of Door
- 1 5/8" of Seamless Drylight as Fire Protection

OPTIONS

- Left-Swing Door Available

VD8030BFQ
Chocolate Brown with
Black Nickel Hardware

VAULT DOORS



Color Options



Hardware Options

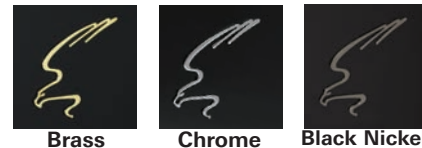

VD8030BF / VD8036BF

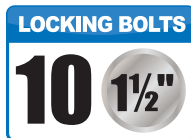

VD8030BFQ / VD8036BFQ

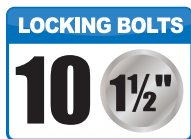

Model	Description	Wall Opening	Door Opening	Weight (lbs.) Door Only	Shipping Wt. Lbs.
VD8030BFQ	Vault Door	79-1/2" x 29-1/2"	77-1/2" x 24-3/4"	506	650
VD8030BFQIS	In-Swing Vault Door	79-1/2" x 29-1/2"	77" x 20-3/8"	490	634
VD8036BFQ	Vault Door	79-1/2" x 35-1/2"	77-1/2" x 31"	592	762
VD8036BFQIS	In-Swing Vault Door	79-1/2" x 35-1/2"	77" x 26-1/4"	556	726
VD8030BF	Vault Door	79-1/2" x 29-1/2"	77-1/2" x 24-3/4"	695	839
VD8030BFIS	In-Swing Vault Door	79-1/2" x 29-1/2"	77" x 20-3/8"	672	816
VD8036BF	Vault Door	79-1/2" x 35-1/2"	77-1/2" x 31"	819	989
VD8036BFIS	In-Swing Vault Door	79-1/2" x 35-1/2"	77" x 26-1/4"	792	957



These elegant, well-appointed 2-drawer and 4-drawer interior chests are the most sophisticated way to store and display your jewelry collection and letter files. These stunning chests are finely crafted with solid-wood maple drawer fronts and maple veneer and finished in a rich honey maple stain. Recessed door pulls give these cabinets a more streamlined appearance and makes for an easier fit into a variety of AMSEC safes. All drawers are elegantly lined in a silky, dark red felt and include a variety of Stor-It Jewelry Organizer Inserts.



TWO-DRAWER CABINET

Top drawer includes a Three Compartment Ring Organizer and a Seven Compartment Jewelry Organizer. Bottom drawer can be used for bulky items or as a file drawer.

FOUR-DRAWER CABINET

Top drawer includes a Three Compartment Ring Organizer and a Seven Compartment Jewelry Organizer. Drawer Two Includes a

Three Compartment Necklace Organizer. Drawer Three Includes a Four Compartment Watch Organizer. Drawer Four is left open for easy storage of large, bulky items.



Storage Cabinet Specifications

Model	Outside Dimensions (HxWxD)	Weight
2-Drawer	16 ¾ x 16 x 14 ½	28
4-Drawer	16 ¾ x 16 x 14 ½	29

StorIt-Cabinets are available as an option on the following Gun Safe models:

RF6528, RF703620X6, RF582820X6, BFX7250*, BFX7240, BFX6636, BFX6030, BFII7250*, BFII7240, BFII6636, BFII6030, NF6036E5, NF6030E5.

Cabinets do not fit any 6032, 6024 or 5924 models, the FV Series or the TF Series.

*No kit needed for installation on BFX7250 & BFII7250 - Cabinets slide right in.

NOTE: DIFFERENT INTERIOR NEEDS TO BE ORDER WHEN ORDERING CABINETS. REFERENCE INTERIOR KITS ON PRICE SHEET.

THE SAFE CLOAK



HIDE YOUR GUN SAFE IN PLAIN SIGHT!

Instantly disguise your gun safe with Amsec's Safe Cloak. Available in five different sizes, the Safe Cloak attaches to your gun safe to instantly disguise it as a wood cabinet. Strong magnets and a sewn-in PVC board at the top easily and securely hold the cloak in place. The thermal-transfer, four-color wood-cabinet print is so good, it will fool not only passersby, but guests as well.

Available in the following sizes: 6024, 6030, 6636, 7240, 7250.

ELECTRONIC LOCK OPTIONS

For quick and easy entry, an electronic lock is the lock of choice. These locks are powered by batteries located in the keypad and allow you to change your combination anytime.

AMERICAN SECURITY



AMSEC ESL10XL
Available in Brass, Chrome and Black Nickel Finish



AMSEC ESL5
Available in Brass, Chrome and Black Nickel Finish



LP LOCKS
ROTOBOLT REDUNDANT LOCK
The convenience of an Electronic lock and the trusted reliability of a mechanical combination lock.



S&G MODEL 6120
Available in Brass or Chrome Finish



S&G TITAN
"EZ" Keypad, Brass, Chrome or Black Nickel Finish



LAGARD
LG BASIC
Chrome Finish

OTHER OPTIONS



.50 CALIBER HANDLE
Available in Black Nickel RF, BFX, BFII & NF Gun Safes only.



POWER STRIP
3 Outlet Power Strip with two USB ports and removable cord.



DESICCANT
Prevents rust and moisture damage. Recommended for safes without electrical access.



JEWELRY DRAWER
Velvet lined jewelry drawer that can be installed on top or underneath any shelf larger than 10" wide and 13¹³/₁₆ deep.



36" LED LIGHT KIT
Has two 36" light strips with high-intensity white LED lights and a motion sensor that automatically turns the lights on when motion is detected. The lights turn off 30 seconds after motion has stopped. This light kit can be installed on any AMSEC safe and is also available as a retrofit kit.



DEHUMIDIFIER ROD
Keeps your guns safe from the threat of rust, pitting and moisture damage. Electrical access required.



PISTOL RACK
This four-gun rack is ideal for organizing pistols inside your safe.



8" COMPACT LED LIGHT KIT
Features two 8" light strips with high-intensity white LED lights and a motion sensor that automatically turns the lights on when motion is detected. Comes with battery box.



AR GUN RACKS
These gun racks are fully adjustable and custom fit the side shelf area of our BFX & BFII series gun safes. Each rack is designed with enough clearance to accommodate extra large front sights or optics. All racks feature rich pin-dot fabric.

PREMIUM UPGRADE PACKAGE FOR RF, BFX, NF AND SF SAFES

When you choose to upgrade your American Security RF, BFX, NF or SF Series with a Premium Package, we'll add on some of our most popular options, including the Dehumidifier Rod, a Jewelry Drawer, an LED light kit*, and a 3-outlet power strip with USB.

*LED light kit standard on BFX gun safes

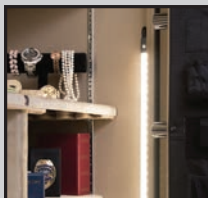

FEATURES AT A GLANCE

Model	Exterior Dimensions	Gun Capacity	Weight	PDO Included	Bolts	Bolt Dia.	Relocker
RF SERIES							
RF703620X6	76" x 42" x 29¼"	12-12-12-24-36 Gun +2 Gun or 58 + 2 Gun	4,578	Yes	10	1½"	Yes
RF582820X6	64" x 34" x 29¼"	12-12-24 Gun + 2 Gun	3,418	Yes	10	1½"	Yes
RF6528	72" x 35" x 29½"	12-12-24 Gun + 2 Gun	3,455	Yes	10	1½"	Yes
BFII SERIES							
BFII7250	71-¼" x 50" x 28"	14-14-14-28-42 + 2 Gun or 73 + 2 Gun	2,438	Yes	10	1½"	Yes
BFII7240	71-¼" x 40" x 26"	12-12-12-24-36 + 2 Gun or 58 + 2 Gun	1,991	Yes	10	1½"	Yes
BFII6636	65-¼" x 36" x 26"	12-12-24 + 2 Gun	1,716	Yes	10	1½"	Yes
BFII6030	59-¼" x 30" x 26"	11-11-22 + 2 Gun	1,395	Yes	10	1½"	Yes
BFII6032	59-¼" x 30" x 21"	9-9-18 + 2 Gun	1,244	Yes	10	1½"	Yes
BFII6024	59-¼" x 24" x 21"	8-8-16 Gun + 1 Gun	1,067	Yes	10	1½"	Yes
BFX SERIES							
BFX7250	71-¼" x 50" x 28"	14-14-14-28-42 + 2 Gun or 73 + 2 Gun	1,851	Yes	16	1½"	Yes
BFX7240	71-¼" x 40" x 26"	12-12-12-24-36 + 2 Gun or 58 + 2 Gun	1,647	Yes	16	1½"	Yes
BFX6636	65-¼" x 36" x 26"	12-12-24 + 2 Gun	1,375	Yes	16	1½"	Yes
BFX6030	59-¼" x 30" x 26"	11-11-22 + 2 Gun	1,081	Yes	14	1½"	Yes
BFX6032	59-¼" x 30" x 21"	9-9-18 + 2 Gun	958	Yes	14	1½"	Yes
BFX6024	59-¼" x 24" x 21"	8-8-16 Gun + 1 Gun	751	Yes	10	1½"	Yes
NF SERIES							
NF6036E5	59" x 36" x 26"	17-17-34 + 2 Gun	977	Yes	14	1½"	Yes
NF6030E5	59" x 30" x 26"	14-14-28 + 2 Gun	854	Yes	14	1½"	Yes
NF6032E5	59" x 30" x 21"	9-9-18 + 2 Gun	761	Yes	14	1½"	Yes
NF5924E5	59" x 24" x 18"	8-8-16 Gun + 1 Gun	600	Yes	14	1½"	Yes
SF SERIES							
SF7240E5	72" x 40" x 26"	15-15-15-30-45 + 2 Gun	1,007	Yes	14	1¼"	Yes
SF6036E5	59" x 36" x 26"	17-17-34 + 2 Gun	834	Yes	14	1¼"	Yes
SF6030E5	59" x 30" x 26"	15-15-30 + 2 Gun	740	Yes	14	1¼"	Yes
SF6032E5	59" x 30" x 21"	11-11-22 + 2 Gun	662	Yes	14	1¼"	Yes
TF SERIES							
TF5924E5	59" x 24" x 18"	8-8-16 Gun + 1 Gun	388	Yes	14	1¼"	Yes
TF5517E5	55-¼" x 17-¾" x 16"	11 Gun	286	Yes	8	1"	Yes

Dimensions listed are exterior dimensions. Add 2³/₄" on all RF, BF and NF safes and 2" on all other safes to overall depth for lock and handle.

FEATURES AT A GLANCE

	Warranty	U.L. Listing	Thickness		Fire Rating	Standard Lock	Handle	Standard Interior
			Door Overall/ Steel Plate	Body				
	Lifetime Theft & Fire	TL-30X6	6"	3"	120 min / 1850°	Spy-Proof, Key-Locking Dial	5-Spoke	Tan Pin-Dot
	Lifetime Theft & Fire	TL-30X6	6"	3"	120 min / 1850°	Spy-Proof, Key-Locking Dial	5-Spoke	Tan Pin-Dot
	Lifetime Theft & Fire	TL-30	6"	3½"	120 min / 1850°	Spy-Proof, Key-Locking Dial	5-Spoke	Tan Pin-Dot
	5-year parts and labor warranty when purchased with a factory installed AMSEC lock. Special lifetime warranty for damage from burglary attempts and fire.	RSC Level II	4¾" / ½"	2¼"	ETL 120 min / 1200°	Spy-Proof, Key-Locking Dial	5-Spoke	Tan Pin-Dot
		RSC Level II	4¾" / ½"	2¼"	ETL 120 min / 1200°	Spy-Proof, Key-Locking Dial	5-Spoke	Tan Pin-Dot
		RSC Level II	4¾" / ½"	2¼"	ETL 120 min / 1200°	Spy-Proof, Key-Locking Dial	5-Spoke	Tan Pin-Dot
		RSC Level II	4¾" / ½"	2¼"	ETL 120 min / 1200°	Spy-Proof, Key-Locking Dial	5-Spoke	Tan Pin-Dot
		RSC Level II	4¾" / ½"	2¼"	ETL 120 min / 1200°	Spy-Proof, Key-Locking Dial	5-Spoke	Tan Pin-Dot
		RSC Level II	4¾" / ½"	2¼"	ETL 120 min / 1200°	Spy-Proof, Key-Locking Dial	L-Handle	Tan Pin-Dot
	5-year parts and labor warranty when purchased with a factory installed AMSEC lock. Special lifetime warranty for damage from burglary attempts and fire.	RSC Level I	4⅝" / ⅜"	2"	ETL 120 min / 1200°	Spy-Proof, Key-Locking Dial	5-Spoke	Tan Pin-Dot
		RSC Level I	4¾" / ½"	2"	ETL 120 min / 1200°	Spy-Proof, Key-Locking Dial	5-Spoke	Tan Pin-Dot
		RSC Level I	4¾" / ½"	2"	ETL 120 min / 1200°	Spy-Proof, Key-Locking Dial	5-Spoke	Tan Pin-Dot
		RSC Level I	4¾" / ½"	2"	ETL 120 min / 1200°	Spy-Proof, Key-Locking Dial	5-Spoke	Tan Pin-Dot
		RSC Level I	4¾" / ½"	2"	ETL 120 min / 1200°	Spy-Proof, Key-Locking Dial	5-Spoke	Tan Pin-Dot
		RSC Level I	4⅝" / ⅜"	2"	ETL 120 min / 1200°	Spy-Proof, Key-Locking Dial	3-Spoke	Tan Pin-Dot
	Lifetime Theft & Fire	RSC Level I	4¼" / ¼"	11 ga.	ETL 90 min / 1200°	ESL5 Electronic Lock	5-Spoke	Gray Fabric
	Lifetime Theft & Fire	RSC Level I	4¼" / ¼"	11 ga.	ETL 90 min / 1200°	ESL5 Electronic Lock	5-Spoke	Gray Fabric
	Lifetime Theft & Fire	RSC Level I	4¼" / ¼"	11 ga.	ETL 90 min / 1200°	ESL5 Electronic Lock	5-Spoke	Gray Fabric
	Lifetime Theft & Fire	RSC Level I	4¼" / ¼"	11 ga.	ETL 90 min / 1200°	ESL5 Electronic Lock	5-Spoke	Gray Fabric
	Lifetime Theft & Fire	B-Rate	3⅝" / ⅜"	12 ga.	ETL 60 min / 1200°	ESL5 Electronic Lock	3-Spoke	Gray Fabric
	Lifetime Theft & Fire	B-Rate	3⅝" / ⅜"	12 ga.	ETL 60 min / 1200°	ESL5 Electronic Lock	3-Spoke	Gray Fabric
	Lifetime Theft & Fire	B-Rate	3⅝" / ⅜"	12 ga.	ETL 60 min / 1200°	ESL5 Electronic Lock	3-Spoke	Gray Fabric
	Lifetime Theft & Fire	B-Rate	3⅝" / ⅜"	12 ga.	ETL 60 min / 1200°	ESL5 Electronic Lock	3-Spoke	Gray Fabric
	Lifetime Theft & Fire	B-Rate	3⅝" / ⅜"	14 ga.	30 min / 1200°	ESL5 Electronic Lock	3-Spoke	Gray Fabric
	Lifetime Theft & Fire	B-Rate	3¼" / ⅜"	14 ga.	30 min / 1200°	ESL5 Electronic Lock	"L" Handle	Gray Fabric



THE INDUSTRY LEADER FOR OVER 75 YEARS



NF6030E5

Since 1946 American Security Products has protected the assets of our clients throughout the world by providing a broad array of safes and consulting services with the highest degree of quality, integrity and responsiveness. Customers have trusted AMSEC safes for generations. The design of each AMSEC safe draws on 75 years of experience on protecting the physical assets of our customers. There aren't many criminals with 75 years of experience, so we think that gives us the advantage.

Before the American Security name is attached, each safe must undergo a rigid 28-point inspection. In addition, every AMSEC safe undergoes the industry's most comprehensive testing program. AMSEC uses independent agencies such as Underwriters Laboratories to put our designs to the test. We maintain the tightest tolerances and highest standards of fit and finish in the industry.

Our commitment doesn't end there. We have built our company on the commitment to offer the best service in the industry which will insure that AMSEC remains the industry leader.

Our corporate center is staffed with highly trained Customer Service Representatives and our Service Department is supported by 7,500 factory-trained technicians throughout the world. Technicians are available 24 hours a day, 365 days a year to answer questions and help solve problems with any safe shipped anywhere in the world. We have been providing safes and security solutions to the banking industry since 1946. This type of high security technology is built right into our gun safes.

We produce over 60,000 safes each year and we take protecting our customers' assets very seriously. That's how we got to be the largest security safe manufacturer in the world, and that's why you can't buy a better gun safe than an American Security safe.

Simply put, our reputation is built on product design, innovative technology and the best support in the industry.

It has worked for us for 75 years and it ensures our complete customer satisfaction. The choice is easy:



American Security Products Co.

11925 Pacific Avenue, Fontana, CA 92337

951-685-9680

www.amsecusa.com

AMSEC reserves the right to update products as necessary. AMSEC is not responsible for typographical errors.

Part #4305172 21v1

Revised 01/21

