

PFA135

Water-proof Junction Box



Features

- Material: Aluminum
- Junction Box
- Neat & Integrated design

Specifications

Model	PFA135
General	
Material	Aluminum
Dimension	φ90x33.7mm
Inch Thread	M20(G1/2")
Operating Temperature	-40°C ~60°C
Humidity	0~90% RH
Load Bearing	1.0Kg
Weight	0.14Kg
Color	White
Applicable Model	Please see "Accessory Selection"

PFA135

Dimensions (mm)

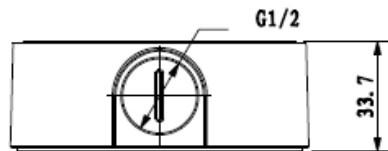
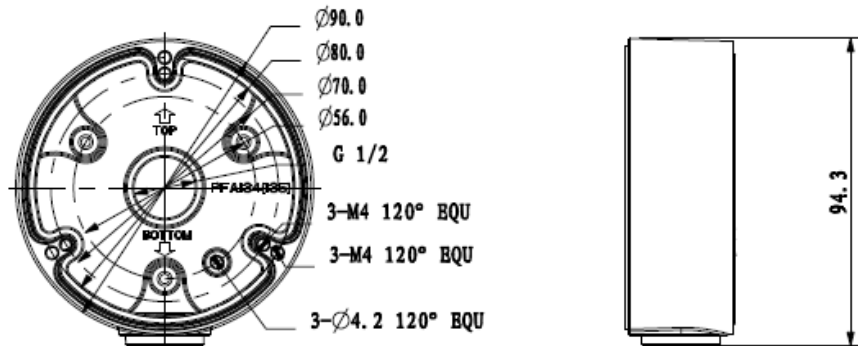

Application

