



American Amplifier Technologies, LLC

Innovative Ideas, Quality Products, Competitive Prices

Product Catalog

2024

TABLE OF CONTENTS

Transmitters.....	7
E Series FM Transmitters	8
1 kW to 3.5 kW E Series FM Transmitters.....	10
5 kW and 6 kW E Series FM Transmitters	11
High Power E Series FM Transmitters.....	12
100 Watt - 6 kW TXN Series FM Transmitters	14
High Power TXN Series FM Transmitters	16
UHF & VHF Digital TV Transmitters.....	18
STL 950 MHz Amplifiers	20
FM IPA Modules.....	21
TV Modulators	22
AAT-M800 ATSC 1.0/3.0 Modulator	23
AAT-P400D Modulator.....	27
AAT-P1000.....	29
AAT-4400 IRD	31
AAT-P160 IRD	34
AAT-DVM-1903ML 8VSB Modulator.....	36
Bandpass Filters and Combiner Systems	38
FM Bandpass Filters	39
FM Bandpass Filters	40
FM Bandpass Filters with Cross-Coupled Notch	41
FM Combiner Systems	42
UHF TV Combiner Systems.....	43
Low Pass Filters	44
UHF Mask Filters	46
UHF Mask Filters	47
VHF Band I & III Mask Filters.....	48
VHF Band I & III Mask Filters.....	49
FM Isocoupler	50
RF Isolators.....	51
Dummy Loads.....	52

RF Power Meters.....	53
PM Series RF Power Meters.....	54
RF Power Meter Remote Display	55
PM Series RF Power Meters.....	56
Monitor and Control Systems	57
De-Icer Controller Unit.....	58
Rack Mountable Dehydrator.....	59
Rack Mountable Dehydrator.....	60
AC Voltage Surge Protection.....	61
AC Voltage Surge Protection.....	62
EC Series Voltage Monitoring Systems	63
FM Antenna Systems	64
SF-M FM Antenna Systems	65
SF-M FM Antenna Systems	66
SF-HP FM Antennas.....	67
SF-HP FM Antenna Systems	68
FM IV-CP Antenna Systems.....	70
FM IV-CP-M Antenna System.....	71
FM IV-CP-M Antenna Systems	72
FM V-DP	73
FM V-DP	74
FM V-DP-M Antenna System	75
FM V-DP-M.....	77
FM V-DP-H Antenna Systems.....	78
FM V-DP-H Antenna Systems.....	79
H Series FM Antenna Systems	80
H Series FM Antenna System	81
FM Panel Antenna Systems.....	82
FM Panel Antenna Systems.....	83
FDP-1 FM Antenna	84
FDP-1 FM Antenna System	85
FDP-1-SP FM Antenna Systems.....	86
FDP-1-SP FM Antenna System	87

FM 3-Element Yagi Antenna System.....	88
FM 3-Element Yagi Antenna System.....	89
FM Log-Periodic Antenna System.....	90
FM Log-Periodic Antenna System.....	91
TV Antenna Systems.....	92
UHF Slot TV Antenna Systems.....	92
UHF Slot TV Antenna System.....	94
UHF Panel TV Antenna Systems.....	95
VHF Band I & III Panel Antennas.....	96
STL Antenna Systems.....	97
STL 950 MHz Full Parabolic Antenna Systems.....	98
STL 950 MHz Full Parabolic Antenna Systems.....	99
Coaxial and Rigid Line Products.....	100
Rigid Transmission Line.....	101
7/8" Rigid Transmission Line and Components.....	102
1 5/8" Rigid Transmission Line and Components.....	103
3 1/8" Rigid Transmission Line and Components.....	105
4 1/16" Rigid Transmission Line and Components.....	106
6 1/8" Rigid Transmission Line and Components.....	107
Coaxial Line Products.....	108
Coaxial Line Product.....	109
RG11 Coax:.....	109
RG11 Coax Connectors:.....	109
LMR400 3/8" Coax:.....	109
LMR400 3/8" Coax Connectors:.....	109
1/2" Standard Coax:.....	109
1/2" Standard Coax Connectors:.....	109
1/2" Super Flex Coax:.....	110
1/2" Super Flex Coax Connectors:.....	110
7/8" Foam Coax:.....	110
7/8" Foam Coax Connectors:.....	110
7/8" Air Pass Coax:.....	111
7/8" Air Pass Connectors:.....	111

1-5/8" Foam Coax:.....	111
1-5/8" Foam Coax Connectors:.....	111
1-5/8" Air Pass Coax:	111
1-5/8" Air Pass Connectors:.....	111
3" Air Pass Coax:	111
3" Air Pass Coax Connectors:.....	112
4" Air Pass Coax:	112
4" Air Pass Coax Connectors:.....	112
5" Air Pass Coax	112
5" Air Pass Coax Connector	112
60/60 Hz Single Phase to Three Phase Converters	113
5 – 300 HP Phase Converters	115
AI Phase Converters	117
Phase Converters	118

American Amplifier Technologies™

American Amplifier Technologies provides a variety of products and services. AAT products are designed and manufactured with quality materials, simplicity, and thorough engineering. Our dedication to these principles ensures our products are quality investments to the end user.

Email: sales@americanamptech.com

Website: AmericanAmpTech.com

Phone: 916-978-1899

MAILING ADDRESS:

American Amplifier Technologies™
7889 Lichen Dr. #360
Citrus Heights CA 95621 US

AAT LOCATIONS:

CALIFORNIA:

3485 Orange Grove Ave Suite L
North Highlands, CA 95660

ARIZONA:

2401 W Phelps Rd Suite C
Phoenix, AZ 85023

Transmitters

American Amplifier Technologies transmitters are designed and built using the latest solid state technology. Extensive monitoring and control options are available via Ethernet and Remote Samples.

Features:

- Available for FM and TV (UHF, VHFI, VHFIII)
- Solid state power MOSFET Technology
- Reliable design and manufacturer
- Efficient state-of-the-art transistors and power supplies
- Extensive monitoring via Ethernet and Remote Samples

E Series FM Transmitters

50 W – 60 kW FM Transmitters



- Class Leading Features: Stereo Encoder, RBDS/RDS Generator, & SCA.
- Reliable Design and Manufacturer
- Frequency Agile 87.5 - 108MHz
- AES, MPX, and Analog Audio Inputs
- Efficient State-of-the-Art Transistors and Power Supplies
- Extensive Monitoring via Ethernet, SNMP, and Remote Samples

Audio Characteristics:

Left-Right Analog Operation	Input Impedance	600Ω, 10 KΩ (selectable from front panel)
	Input Connector	XLR (balanced)
	Input Level Max	+10 dBm +/- 2dB (others available)
	Harmonic Distortion	<1% (50 Hz-15KHz)
	S/N Ratio	>-60dB FM noise, >-50dB AM noise
	Pre-emphasis	25, 50, 75 μS, or flat response (selectable)
MPX Operation	Input Impedance	10 KΩ Unbalanced
	Input Connector	BNC
	Harmonic Distortion	< 1% (50 Hz-15KHz)
	S/N Ratio	> 65 dB
SCA Operation	Number of Inputs	2
	Input Connector	BNC Female
	Input Level	+10 dBm Nominal
	Frequency Range	57 to 93 kHz
Digital Audio	AES/EBU	XLR, 3-position, Female
	S/PDIF	Optical, Toslink
	S/PDIF	Coaxial, RCA Female

RF Characteristics:

Output Impedance	50 Ω
Operating Modes	FM, FM+HD, HD Only, DRM
Frequency Range	87.5 – 108.0 MHz (± 1 kHz stability)
Power Level	Adjustable 1 – 102%
Output Connector	3-1/8" EIA Female
Maximum VSWR	1.40 : 1
Overall Efficiency	Typically 71% or Better (Analog Only)

Electrical:

Flexible AC Input	AC Power Single Phase	200 - 250 VAC +/-10% 50/60Hz
	AC Power Three Phase	200 - 250 VAC +/-10% 50/60Hz

Interface:

Remote Port	Control:	RF Carrier on/off, RF Power up/down, Reset
	Monitor:	Forward, Reflected, Current, Voltage, Temperature
	Flags:	Amplifier Overdrive, VSWR (Adjustable Trip Point), High Temperature
Ethernet	Control:	RF Carrier on/off, RF Power up/down, AGC/manual, Change VSWR Trip Point, Reset
	Monitor:	Forward/Reflected RF Level, DC Pallet Voltage, RF Input Level, Temperature, VSWR Trip Point, Model, S/N
	Flags:	Carrier on/off, Amplifier Overdrive, DC Pallet Voltage, VSWR, RF Input Level, Temperature, AGC/Manual Status
SNMP	Control:	RF Carrier on/off, RF Power up/down, AGC/Manual, Change VSWR Trip Point, Reset
	Monitor:	Forward/Reflected RF Level, DC Pallet Voltage, RF Input Level, Temperature, Pallet current, Attenuation, Run Time, RF Fault, Model/Serial Number
	Flags:	Amplifier Overdrive, VSWR, Temperature, SNMP Error
RBDS/RDS	Input Connector	USB
	Features	Scrolling, Parsing, Advanced Weekly Scheduling, UECP, ASCII Terminal Control
	Supported Commands	PI, PS, PTY, TP, AF, TA, PTYN, DI, EON, RT+, M/S, PIN, ECC, RT, TDC, IH, ODA, CT, LIC, TMC



OLED Display



Exciter Rear Panel Connections

Physical Features:

Minimal Rack Space	2U – 50W/150W/300W/500W; 3U – 750W/1kW/1.5kW; 4U – 2kW/2.5kW/3kW;	U (H) x 25" - 36" (D) x 19" (W)
	6U – 3.5kW/5kW/6kW; 42U – 8kW/10kW; 48U – 12kW/14kW/20kW/25kW; 96U-30kW/40kW/60kW	U (H) x 40" - 43" (D) x 24" (W)
Weight	50W - 30 lbs; 150W - 35 lbs; 300W - 40 lbs; 500 W - 45 lbs; 750W - 65 lbs; 1kW - 70 lbs; 1.5kW - 75 lbs; 2kW - 80 lbs; 2.5kW - 90 lbs 3kW - 100 lbs 3.5kW - 130 lbs; 5kW - 160 lbs; 6kW - 170 lbs; 8kW - 450 lbs; 10kW - 800 lbs; 12kW - 900 lbs; 14kW - 950 lbs; 20kW - 1000 lbs; 25kW – 1150 lbs. 1200lbs- 30kW; 1500 lbs 40 kW; 1800 lbs 60kW	

Environmental:

Maximum Elevation	10,000 ft.
Operating Temperature	0 to +59° C
Air Flow Max CFM	2,000 ft ³ /min
Humidity	90%, non-condensing

1 kW to 3.5 kW E Series FM Transmitters



Features:

- Solid State Power MOSFET Technology
- HD Ready
- Frequency 87.5 – 108MHz
- Extensive Monitoring via Ethernet and Remote Samples



Specifications:

Model	FM-1000E, FM-2000E, FM-3000E, FM-3500E
Output Impedance	50 Ω
Frequency Range	87.5 – 108.0 MHz
Nominal Output Power	Model dependent (1 kW, 2 kW, 3 kW, 3.5kW)
Output Connector	7/16" DIN 7/16, 7/8 EIA
Spurious Emissions	Compliant to Industry Canada BETS-6 and FCC 73.317

Electrical:

AC Input Voltage	200 - 250 Vac
Overall Power Consumption	1 kW = 1.470 kW, 2 kW = 2.941 kW, 3 kW = 4.411 kW , 3.5 kW = 5.147 kW
Overall Efficiency	>68%
PA Power Consumption	1 kW = 1.282 kW, 2 kW = 2.564 kW, 3 kW = 3.846 kW, 3.5 kW = 4.487 kW
PA Efficiency	>78%

Interface:

Remote Port	Control:	RF carrier on/off, Reset
	Monitor:	Forward/reflected RF level, control PCB Vcc
	Flags:	VSWR, Current, Voltage, Forward Power
Ethernet	Control:	RF carrier on/off, Reset
	Monitor:	Forward/reflected RF level, DC pallet voltage, RF input level, temperature, VSWR trip point, model
	Flags:	Carrier on/off, amplifier overdrive, DC pallet voltage, VSWR, RF input level, AGC/manual status
LCD Display	Monitor:	Forward/reflected RF level, DC pallet voltage, RF input level, pallet current
	Flags:	VSWR, Current, Voltage, Forward Power

Physical Features:

Minimal Rack Space	3U	5.25" (H) x 21" (D) x 19" (W)
Lightweight Enclosures	Aluminum	
Operating Temperature	0 to +59 °C	
Humidity	90%, non-condensing	

5 kW and 6 kW E Series FM Transmitters

Features:



- Solid State LDMOS Technology
- HD Ready
- Frequency 87.5 – 108MHz
- Extensive Monitoring via Ethernet and Remote Samples



Specifications:

Models	FM-5000E, FM-6000E
Output Impedance	50 Ω
Frequency Range	87.5 – 108.0 MHz
Nominal Output Power	5000 watt, 6000 watts
Power Level	Adjustable 1 – 105%
Output Connector	7/8 EIA
Spurious Emissions	Compliant to Industry Canada BETS-6 and FCC 73.317

Electrical:

AC Input Voltage	208 - 250 Vac
Overall Power Consumption	5 kW = 7.352 kW, 6 kW = 8.822 kW
Overall Efficiency	>69%
PA Power Consumption	5 kW = 6.410 kW , 6 kW = 7.692 kW
PA Efficiency	>78%

Interface:

Remote Port	Control:	RF Carrier on/off, Reset, Raise/Lower Power
	Monitor:	Forward/reflected RF level, control PCB Vcc
	Flags:	VSWR, Current, Voltage, Forward Power
Ethernet	Control:	RF Carrier on/off, Reset, Raise/Lower Power
	Monitor:	Forward/reflected RF level, DC pallet voltage, RF input level, temperature, VSWR trip point, model
	Flags:	Carrier on/off, Overdrive, DC pallet voltage, VSWR, RF input level, AGC/manual status
LCD Display	Monitor:	Forward/reflected RF level, DC pallet voltage, RF input level, pallet current
	Flags:	VSWR, Current, Voltage, Forward Power

Physical Features:

Minimal Rack Space	12U	12.25" (H) x 30" (D) x 19" (W)
Lightweight Enclosures	Aluminum	
Operating Temperature	0 to +59 °C	
Humidity	90%, non-condensing	

High Power E Series FM Transmitters

Features

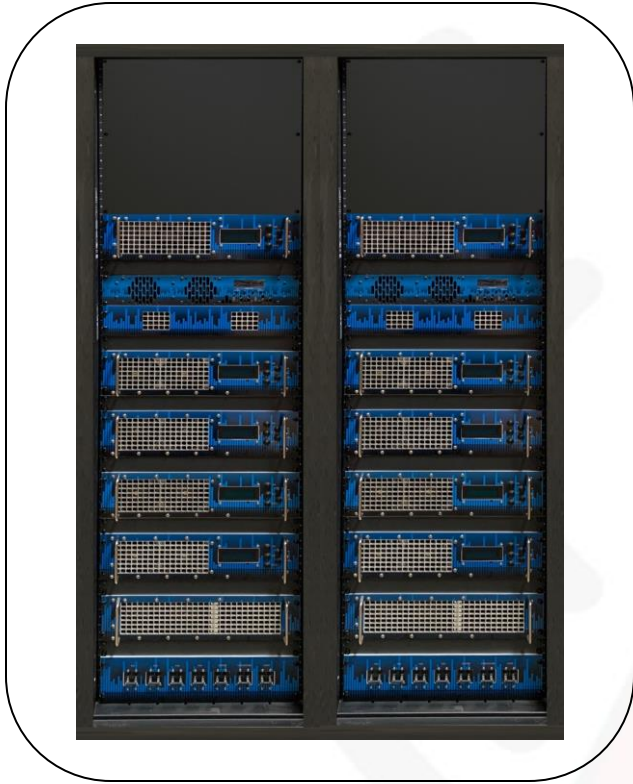

- Class Leading Features: Stereo Encoder, RBDS/RDS Generator, and SCA.
- Frequency: 87.5 - 108MHz
- AES, MPX, and Analog Audio Inputs
- Extensive Monitoring via Ethernet, SNMP, SMTP, and Remote Samples
- HD Ready

Specifications:

Model	FM-10,000E, FM-20,000E, FM-25,000E, FM-30,000E, FM-40,000E, FM-50,000E, FM-60,000E
Output Impedance	50 Ω
Frequency Range	87.5 – 108.0 MHz
Nominal Output Power	Model dependent
Output Connector	3-1/8", 4-1/16", 6-1/8" EIA
Spurious Emissions	Compliant to Industry Canada BETS-6 and FCC 73.317
Operating Modes	FM, FM+HD, HD Only, DRM

Electrical:

AC Input Voltage	200 - 250 VAC 50/60 Hz Single or Three Phase
Overall Efficiency	>68% (analog)
PA Efficiency	>78% (analog)

Interface:

Remote Port	Control:	RF carrier on/off, Reset
	Monitor:	Forward/reflected RF level, control PCB Vcc
	Flags:	VSWR, Current, Voltage, Forward Power
Ethernet	Control:	RF carrier on/off, Reset
	Monitor:	Forward/reflected RF level, DC pallet voltage, RF input level, temperature, VSWR trip point, model
	Flags:	Carrier on/off, amplifier overdrive, DC pallet voltage, VSWR, RF input level, AGC/manual status
LCD Display	Monitor:	Forward/reflected RF level, DC pallet voltage, RF input level, pallet current
	Flags:	VSWR, Current, Voltage, Forward Power

Physical Features

Minimal Rack Space	Full Racks	7 ft Racks
Lightweight Enclosures	Aluminum	
Operating Temperature	0 to +59 °C	
Humidity	90%, non-condensing	

Audio Characteristics:

Left-Right Analog Operation	Input Impedance	600Ω, 10 KΩ (selectable from front panel)
	Input Connector	XLR (balanced)
	Input Level Max	+10 dBm +/- 2dB (others available)
	Harmonic Distortion	<1% (50 Hz-15KHz)
	S/N Ratio	>-60dB FM noise, >-50dB AM noise
	Pre-emphasis	25, 50, 75 μS, or flat response (selectable)
MPX Operation	Input Impedance	10 KΩ Unbalanced
	Input Connector	BNC
	Harmonic Distortion	< 1% (50 Hz-15KHz)
	S/N Ratio	> 65 dB
SCA Operation	Number of Inputs	2
	Input Connector	BNC Female
	Input Level	+10 dBm Nominal
	Frequency Range	57 to 93 kHz
Digital Audio	AES/EBU	XLR, 3-position, Female
	S/PDIF	Optical, Toslink
	S/PDIF	Coaxial, RCA Female



OLED Display

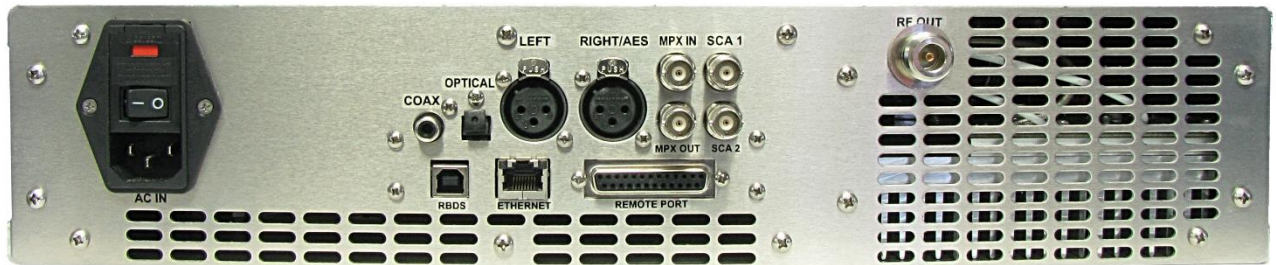

Exciter Rear Panel Connections

100 Watt - 6 kW TXN Series FM Transmitters



Features

- Stereo Encoder, RBDS/RDS Generator, Dynamic RDS, and SCA.
- Frequency: 87.5 - 108MHz
- AES, MPX, and Analog Audio Inputs
- MPX over AES, MPX over IP
- Extensive Monitoring via Ethernet, SNMP, SMTP, and Remote Samples

Specifications:

Model	TXN-100, TXN-300, TXN-600, TXN-1000, TXN-3000, TXN-5000, TXN-6000
Output Impedance	50 Ω
Frequency Range	87.5 – 108.0 MHz
Nominal Output Power	Model dependent
Output Connector	Type N, 7/8" EIA
Spurious Emissions	Compliant to Industry Canada BETS-6 and FCC 73.317
Operating Modes	FM, FM+HD, HD Only, DRM

Electrical:

AC Input Voltage	200 - 250 VAC 50/60 Hz Single or Three Phase
Overall Efficiency	>68% (analog)
PA Efficiency	>78% (analog)

Interface:

Remote Port	Control:	RF carrier on/off, Reset
	Monitor:	Forward/reflected RF level, control PCB Vcc
	Flags:	VSWR, Current, Voltage, Forward Power
Ethernet	Control:	RF carrier on/off, Reset
	Monitor:	Forward/reflected RF level, DC pallet voltage, RF input level, temperature, VSWR trip point, model
	Flags:	Carrier on/off, amplifier overdrive, DC pallet voltage, VSWR, RF input level, AGC/manual status
LCD Display	Monitor:	Forward/reflected RF level, DC pallet voltage, RF input level, pallet current
	Flags:	VSWR, Current, Voltage, Forward Power

Physical Features

Minimal Rack Space	1U – 100W/300W/600W; 3U –1kW /2kW /3 kW 4U – 3.5kW/4kW/5kW/6kW;	U (H) x 25" - 36" (D) x 19" (W)
Lightweight Enclosures	Aluminum	
Operating Temperature	0 to +59 °C	
Humidity	90%, non-condensing	

Audio Characteristics:

Left-Right Analog Operation	Input Impedance	600Ω, 10 KΩ (selectable from front panel)
	Input Connector	XLR (balanced)
	Input Level Max	+10 dBm +/- 2dB (others available)
	Harmonic Distortion	<1% (50 Hz-15KHz)
	S/N Ratio	>-60dB FM noise, >-50dB AM noise
	Pre-emphasis	25, 50, 75 μS, or flat response (selectable)
MPX Operation	Input Impedance	10 KΩ Unbalanced
	Input Connector	BNC
	Harmonic Distortion	< 1% (50 Hz-15KHz)
	S/N Ratio	> 65 dB
SCA Operation	Number of Inputs	2
	Input Connector	BNC Female
	Input Level	+10 dBm Nominal
	Frequency Range	57 to 93 kHz
Digital Audio	AES/EBU	XLR, 3-position, Female
	S/PDIF	Optical, Toslink
	S/PDIF	Coaxial, RCA Female

High Power TXN Series FM Transmitters



Features

- Stereo Encoder, RBDS/RDS Generator, Dynamic RDS, and SCA.
- Frequency: 87.5 - 108MHz
- AES, MPX, and Analog Audio Inputs
- MPX over AES, MPX over IP
- Extensive Monitoring via Ethernet, SNMP, SMTP, and Remote Samples

Specifications:

Model	TXN-10kW, TXN-15kW, TXN-20kW, TXN-25kW, TXN-30kW, TXN-40kW, TXN-60kW
Output Impedance	50 Ω
Frequency Range	87.5 – 108.0 MHz
Nominal Output Power	Model dependent
Output Connector	3-1/8", 4-1/16", 6-1/8" EIA (other available)
Spurious Emissions	Compliant to Industry Canada BETS-6 and FCC 73.317
Operating Modes	FM, FM+HD, HD Only, DRM

Electrical:

AC Input Voltage	200 - 250 VAC 50/60 Hz Single or Three Phase
Overall Efficiency	>68% (analog)
PA Efficiency	>78% (analog)

Interface:

Remote Port	Control:	RF carrier on/off, Reset
	Monitor:	Forward/reflected RF level, control PCB Vcc
	Flags:	VSWR, Current, Voltage, Forward Power
Ethernet	Control:	RF carrier on/off, Reset
	Monitor:	Forward/reflected RF level, DC pallet voltage, RF input level, temperature, VSWR trip point, model
	Flags:	Carrier on/off, amplifier overdrive, DC pallet voltage, VSWR, RF input level, AGC/manual status
LCD Display	Monitor:	Forward/reflected RF level, DC pallet voltage, RF input level, pallet current
	Flags:	VSWR, Current, Voltage, Forward Power

Physical Features

Minimal Rack Space	Full Racks	7 ft Racks
Lightweight Enclosures	Aluminum	
Operating Temperature	0 to +59° C	
Humidity	90%, non-condensing	

Audio Characteristics:

Left-Right Analog Operation	Input Impedance	600Ω, 10 KΩ (selectable from front panel)
	Input Connector	XLR (balanced)
	Input Level Max	+10 dBm +/- 2dB (others available)
	Harmonic Distortion	<1% (50 Hz-15KHz)
	S/N Ratio	>-60dB FM noise, >-50dB AM noise
	Pre-emphasis	25, 50, 75 μS, or flat response (selectable)
MPX Operation	Input Impedance	10 KΩ Unbalanced
	Input Connector	BNC
	Harmonic Distortion	< 1% (50 Hz-15KHz)
	S/N Ratio	> 65 dB
SCA Operation	Number of Inputs	2
	Input Connector	BNC Female
	Input Level	+10 dBm Nominal
	Frequency Range	57 to 93 kHz
Digital Audio	AES/EBU	XLR, 3-position, Female
	S/PDIF	Optical, Toslink
	S/PDIF	Coaxial, RCA Female

UHF & VHF Digital TV Transmitters

25 W – 5 kW TV Transmitters

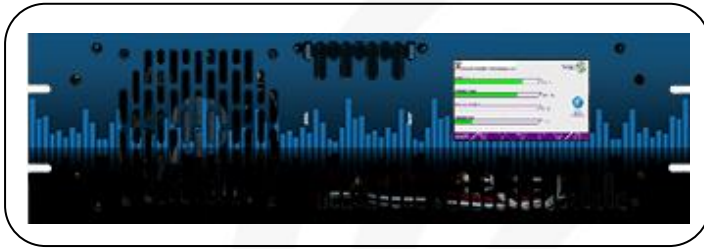

- ATSC 1.0 (ATSC 3.0 Ready)
- COFDM, 8VSB, DVBT/H
- Efficient Transistors and Power Supplies
- Extensive Monitoring via Ethernet, SNMP, and Remote Samples

RF Characteristics:

Frequency Range	VHF 50 – 230 MHz, UHF 470 - 860 MHz	
Input Power	0 dBm into power amplifier from modulator	
Nominal Output Power (8VSB)	VHF: 25W, 40W, 100W, 250W, 500W, 1kW, 2kW, 3kW, 4kW, 5kW	UHF: 40W, 100W, 250W, 500W, 1kW, 2kW, 3kW, 4kW, 5kW
Power Level	Adjustable 10 – 100%	
Input Impedance	50 Ω into amplifier, BNC female	
Output Impedance	50 Ω, N or 7-16 DIN female (dependent on power level)	
Modulation	8VSB, QAM, DVBT/H (output power will change between standards)	
Signal and Noise	MER >36 dB typical	
Phase Jitter	>104 dB	
Shoulders	>-50 dB typical, ATSC mode compliant to ATSC A53/B	

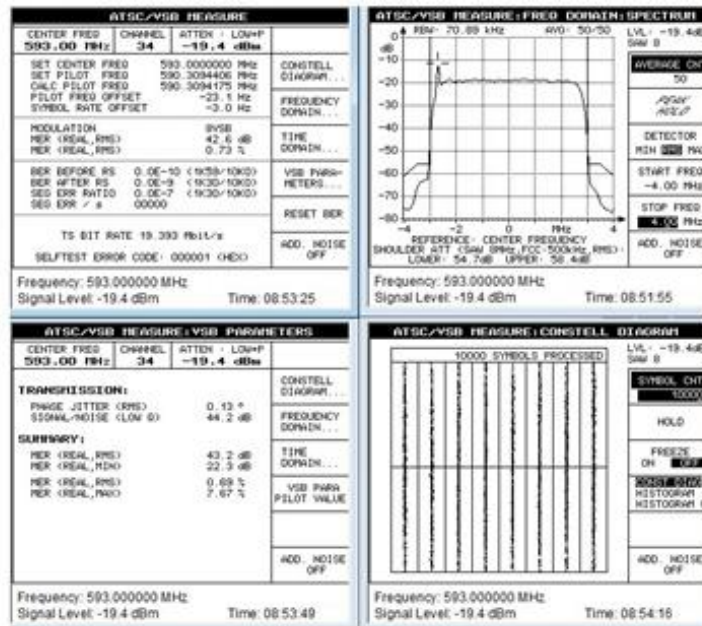

Typical Performance Specifications

Electrical Specifications:

Flexible AC Input	VHF PA: 25W/100W/250W/500W	90-264Vac
	1kW/2 kW/3 kW/4 kW/5kW	180-264Vac
	UHF PA: 25W/100W/250W/500W	90-264Vac
	1kW/2kW/3kW/4kW/5kW	180-264Vac

Interface:

DB25 Remote Port	Control:	RF carrier on/off, RF power up/down, reset
	Monitor:	Forward/reflected RF level, control PCB Vcc
	Flags:	Overdrive, VSWR (adjustable trip point), high temperature
Ethernet	Control:	RF carrier on/off, RF power up/down, AGC/manual mode, change VSWR trip point, reset
	Monitor:	Forward/reflected RF level, pallet voltage, RF input level, temperature, VSWR trip point, model/serial number
	Flags:	Carrier on/off, overdrive, pallet voltage, VSWR, RF input, temperature, AGC / manual
SNMP	Control:	RF carrier on/off, RF power up/down, AGC/manual mode, change VSWR trip point, reset
	Monitor:	Forward/reflected RF level, DC pallet voltage, RF input level, temperature, pallet current, attenuation, run time, RF fault, model/serial number
	Flags:	Overdrive, VSWR, temperature, SNMP error

Physical Features

Minimal Rack Space	VHF PA: 3U – 25W/40W; 5U – 100W/250W/500W; 6U – 1kW; 12U – 2kW; Rack - 3kW/ 4kW/5kW	x 25" (D) x 19" (W)
	UHF PA: 3U – 40W; 5U – 100W/250W/500W; 6U – 1kW; 12U – 2kW; Rack - 3kW/ 4kW/5kW	x 25" (D) x 19" (W)
Lightweight Enclosures	Aluminum	
Operating Temperature	0 to +45° C	
Humidity	90%, non-condensing	



Touch Screen Interface



STL 950 MHz Amplifiers

Features:

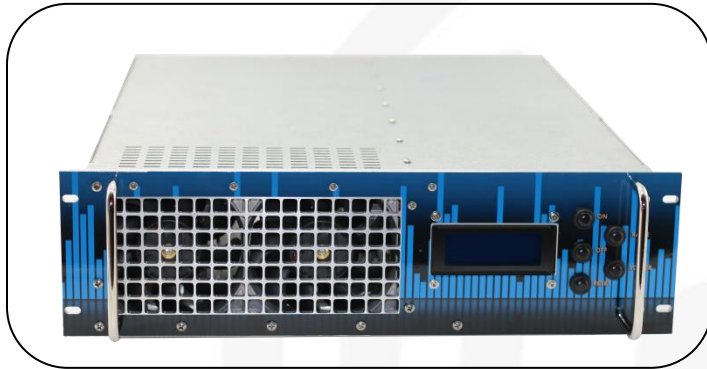

- Solid State Technology
- Frequency 920-960 MHz
- Extensive Monitoring via Ethernet and Remote Samples



Specifications:

Models	STL-15A, STL-35A, STL-50A, STL-100A
Output Impedance	50 Ω
Input Power	5 watts Max
Frequency Range	920 – 960 MHz
Nominal Output Power	Model and modulation type dependent (15, 35, 60, and 100 watt models available)
Power Level	Adjustable 1 – 105%, Linear to input
Output Connector	Type N female
Input Connector	Type BNC
Spurious Emissions	Compliant to Industry Canada BETS-6 and FCC

Electrical Specifications:

AC Input Voltage	120-250 VAC
Overall Power Consumption	Typically 100-200 watts
Overall Efficiency	> 20%
PA Power Consumption	Typically 90 watts
PA Efficiency	> 25% Class A

Interface:

Remote Port	Control:	Reset, On/Off (external exciter)
	Monitor:	Forward/reflected RF level, control PCB Vcc
	Flags:	VSWR, Current, Voltage, Forward Power
Ethernet	Control:	Reset, On/Off (external exciter)
	Monitor:	Forward/reflected RF level, DC pallet voltage, temperature, VSWR trip point, model
	Flags:	DC pallet voltage, current, VSWR
	SNMP:	Yes
LCD Display	Monitor:	Forward/reflected RF level, DC pallet voltage, DC current
	Flags:	VSWR, Current, Voltage, Forward Power

Physical Features:

Minimal Rack Space	3U	U x 21" x 36" (D) x 19" (W)
Lightweight Enclosures	Aluminum	
Operating Temperature	0 to +59° C	
Humidity	90%, non-condensing	

Disclaimer: Specifications are subject to change without notice. Information may be changed or updated without notice. American Amplifier Technologies™ may also make improvements and/or changes in the products described at any time.

FM IPA Modules

350 W – 700 W FM IPA Modules



- 350 W & 700 W Modules
- Excellent for Tube and Solid State IPA stages
- Frequency 88 - 108MHz
- Direct replacement for popular Silicon Valley and MMD IPA modules used in Continental, Harris, and CCA transmitters
- LDMOS XR series FET Technology

Specifications:

Frequency	88 – 108 MHz
Output Power Rating	350 W & 700 W
Voltage	50 VDC
Input / Output	50 ohms
Efficiency	Up to 82%
Gain	24 dB
Connectors	BNC Input, Type N output

Electrical Specifications:

350 W MODULE CHARACTERISTICS	MINIMUM	TYPICAL	MAXIMUM	UNIT OF MEASURE
Output Power	50	250	350	W
DC Voltage	45	50	52	V
Power Input	2	15	17	W
Power Gain	24	25	26	dB
Amplifier Efficiency	77	78	82	%
Maximum Current Rating	-	-	8.75	A

700 W MODULE CHARACTERISTICS	MINIMUM	TYPICAL	MAXIMUM	UNIT OF MEASURE
Output Power	50	500	700	W
DC Voltage	45	50	52	V
Power Input	2	15	17	W
Power Gain	24	25	26	dB
Amplifier Efficiency	77	78	82	%
Maximum Current Rating	-	-	17.5	A

TV Modulators

AAT Digital Modulators and Transmodulators can be paired with any of our Digital TV Transmitters. Formats supported include DVB-ASI, IP, RF, DVB-S2, DVB-T, DVB-c, and ISDB-T. All units follow ATSC A53 specifications.

Available Features:

- Encoding
- Decoding
- Receiving
- Modulating
- Muxing
- PSIP Rebranding
- ASI
- IP
- SDI/HD-SDI
- HDMI
- NTSC

AAT-M800 ATSC 1.0/3.0 Modulator

Available for all digital broadcasting systems



The American Amplifier Technologies AAT-M800 ATSC 1.0 modulator provides optimal performance and efficiency. In addition to a high RF and MER performance, the modulator offers the ability to be upgraded to ATSC 3.0 by a software license installation.

Formats Available

- ATSC 1.0 / ATSC 3.0
- DVB-T/T2
- ISDB-T/Tb
- DAB/DAB+/T-DMB

- Software upgradable to **ATSC 3.0**
- High performance digital adaptive linear and nonlinear precorrection for maximum transmitter performance.
- **OPTIPOWER®** - market leading enhanced adaptive precorrection and PAPR clipping technology for maximum optimization of transmitter power efficiency (Option AAT-M3756)
- **VHF and UHF** (selectable frequency from 30MHz to 860 MHz in steps of 1Hz)
- Integrated Multi Standard Global Navigation Satellite System (GNSS) receiver for time and frequency reference based on **GPS and GLONASS** systems (Option AAT-M3711).
- Three choices of internal precision (Local Oscillator) according to the needs of the system: 2ppm, 0.25ppm or 0.01ppm.
- **4x Ethernet Gigabit** interfaces for control and data transport.
- User friendly intuitive WEB GUI control for use with standard Web Browsers (Internet Explorer, Mozilla Firefox, Google Chrome and Opera compatible).
- **SNMP** client Get/Set/Trap.
- Available software based **Automatic Level Control** to regulate any third party power amplifier output. (Option AAT-M3770/00).
- Modes **M/H** and **SFN** supported.



Application

The AAT-M800 characterized by a high RF and MER performance and by its unique ability to optimize efficiency of any digital TV amplifier using the patented OptiPower Technology.

The AAT-M800 ATSC 1.0 modulator is designed in accordance with the ATSC standard A/53 with respect to ATSC channel coding and modulation. Support for ATSC M/H transmission in accordance to the A/153 standard and support for SFN transmission in accordance with the A/110:B and A/110:2011 revisions of the SFN standard are available as optional features.

When the A/153 M/H option is installed the AAT-M800 modulator will offer a choice between manual selection of either A/53 or A/153 mode and, if preferred, automatic toggling between A/53 and A/153 mode.

The automatic toggling between A/53 and A/153 mode is controlled by the content of the applied input stream (A/153 mode activated whenever the input stream contains the M/H PID that is characteristic of M/H transmission).

The automatic selection of mode facilitates trouble free configuration of the transmitters based on the content of the input stream. The automatic mode selection is ideal for the typical scenario where day time transmissions carry legacy as well as M/H content while the night/ prime time transmissions reserve all bandwidth for legacy content only.

ProTelevision's highly advanced adaptive precorrection technology operating in thousands of installations worldwide has proven its worth and provided Broadcasters a reduction in OPEX cost due to the reduced power consumption.

The software flexibility within the AAT-M800 platform enables the broadcasters and transmitter manufactures to upgrade their systems to the ATSC 3.0 standard by a simple installation of a software license.



Easy Navigation

OPTIPOWER®

Optipower is a ProTelevision Technologies' proprietary solution developed to provide an increase of quality (MER) and efficiency to new or existing TV transmitters.



Optipower consists of:

- 1) Enhanced Nonlinear Precorrection algorithm with **DEEP MEMORY EFFECTS** based on the Volterra polynomial series.
- 2) **Adaptive PAPR clipper**.

These two adaptive mechanisms, allow achieving the maximum MER value on any transmitter system (VHF, UHF, Class AB, Doherty, etc...) compared with other precorrection solutions on the market.

This MER extra increase, can be used to **enhance the overall efficiency of the transmitter system**.

In addition, ProTelevision Optipower (Option TM3756) will provide **live measurements** on the WEB Graphical User Interface: Shoulders, MER, PAPR, MER vs Carrier and a Spectrum graphic on the channel transmitted (see picture).

Main specifications for (Optipower) precorrection and feedback signals: Connectors: SMA 50 ohm // Level: -10dBm to +10dBm // Return Loss > 20dB // Frequency: 30MHz to 860MHz.

SUPPORTED MODULATOR MODES

A/53 ATSC	
A/153 ATSC M/H (option M3713)	
A/110:B and A/110:2011 SFN mode (option M3714)	
Test modes:	Single carrier, 8VSB spectrum driven by null-packet input (PRBS mode)

OUTPUT

RF-output

Connector:	N female, 50 ohm
Center frequency:	Adjustable 30-860 MHz in steps of 1 Hz
Frequency stability:	Internal ref 2 ppm to 0.01 ppm or in accordance with external ref. accuracy
Spectrum polarity:	Inverted and non-inverted, user selectable
Level:	Adjustable [-10, +10] dBm (up to +20 dBm with PT 3740 Option)
Stability:	± 0.5 dB
Return loss:	> 16 dB

Spectrum outside band (for RF Output 0 dBm @ 6 MHz)

+/-3,8 MHz:	0db
+/-4,25 MHz (shoulders):	<-50 dB (typically -55 dB)
Harmonics and spurious:	< -55 dBc
MER:	> 45 dB (typically 50 dB)

Internal frequency reference

Selectable Local Oscillator for customer's specific requirements

M3710/00	TCXO 2 ppm (default)
M3710/10	OCVCXO 0.25 ppm (optional)
M3710/20	OCVCXO 0.01 ppm (optional)

CONTROL INTERFACE

Ethernet interface

Connector:	RJ45 (1 in front panel, 4 in rear panel)
------------	--

RS232/RS485 interface

Connector:	9-pin SUB-D Male in rear panel
------------	--------------------------------

HW interface

Connector:	15-pin SUB-D Female in rear panel
Alarm output:	Two user programmable alarms via separate floating relays, common make-break contacts, contact rating 60V/0.2 A (5 W max)
Input:	Separate Reset control and Output muting control, user programmable activation: ground closure or open

POWER SUPPLY

Voltage:	Accepts all the DC range from 100-240 VAC
Frequency:	47-63 Hz
Power consumption:	Max. 40 W

ELECTRICAL SPECIFICATIONS

Inputs

ASI Inputs/SMTPE-310M inputs	
No. of ASI inputs:	2
Connector:	BNC
Input Impedance:	75 ohm
Return Loss:	> 13 db
Redundancy:	User selectable switching policy between "Primary" and "Secondary" ASI source
Seamless Switching:	Supported for any combination of inputs (ASI/IP) in SFN Configuration

Ethernet ports (1Gbit/sec)

Total No. of ports:	4 (2 of them optimized for Data Input)
Connector:	RJ45 quadruple PCB connector

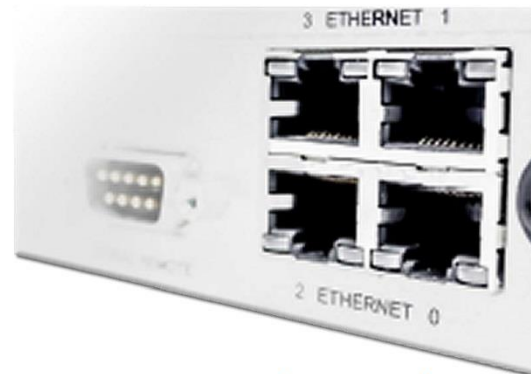

2x Control & Management

2x IP inputs

GNSS Receiver Input (Option M3711)

Connector:	TNC 50 ohm PCB connector
Frequency:	1.575 GHz (GPS) / 1.598-1.606 GHz (Glonass)
Antenna net gain range:	0 to +32 dB
Antenna:	Passive or active antenna (not included)
Antenna DC supply:	OFF, 3 Vdc or 5 Vdc (±0.5 V) user selectable
Antenna DC current:	max 50 mA

External Clock reference (carrier frequency and SFN timing):

Connector:	BNC
Frequency:	10 MHz
Level:	100 mV-3 Vpp
Impedance:	50 ohm/ > 1 kohm, user selectable
Coupling:	AC

Time reference (SFN timing)

Connector:	BNC
Frequency:	1 PPS
Level:	0-5 V, user selectable trigger point 1V or 1.6V
Trigger:	Rising / falling edge, user selectable
Impedance:	50 ohm/ > 1 kohm, user selectable

ENVIRONMENTAL SPECIFICATION

Climatic Temperature range operating:	-5°C to +55°C (+23 F to +131 F)
Temperature range within specs:	+5°C to +45°C (+41 F to +113 F)
Temperature range storage:	-30°C to +70°C (-22 F to +158 F)
Humidity operating:	max 90% RH
Humidity storage:	max 90% RH
EMC	Compliant to EN55022 (emission) and EN55024 (immunity)
Safety	Compliant to EN60950-1
RoHs	Compliant with directive 2011/65/EU

MECHANICAL SPECIFICATION

Cabinet:	19" wide, 1RU high
Width:	19"
Depth:	440 mm
Height:	44 mm (1.75")
Weight :	6 kg (16 lbs)
Cooling:	Long life externally mounted chassis fans to assist natural convection
Transport and storage:	Vibration acc. to IEC Publ. 68

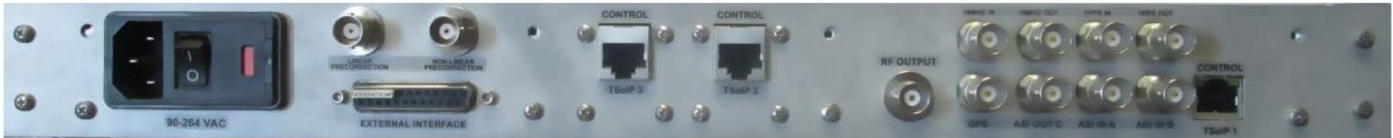

Ordering codes:

ATSC Exciter

M800 ATSC 1.0 Exciter

Options, software

M3713 A/153 ATSC M/H mode*
 M3714 A/110:B and A/110:2011 SFN timing*
 M3754 Adaptive digital Pre-corrector
 M3756 OPTIPOWER®:
 Enhanced pre-correction and adaptive PAPR clipper
 M3770/00 Automatic Level Control
 M3263 ATSC 3.0 License
 M3740 +20 dBm output amplifier

Options, hardware

M3711 GNSS module (GPS and GLONASS support)
 M3710/10 Medium Precision Oscillator OCVCXO 0.25 ppm
 M3710/20 High Precision Oscillator OCVCXO 0.01 ppm

*For transmission to air of these transmission modes/features, it is required a license from the patent owner.

Please check: <http://atsc.org/policies/patent-statements/>

AAT-P400D Modulator

Transmodulator/Processor



OVERVIEW

The P400D is a powerful and cost-effective broadcast level Transmodulator/Processor. It supports signal receiving, multi-channel descrambling, multiplexing, external table/data insertion and transmodulating. It also supports MPEG2/MPEG4 SD/HD program decoding with two audio channels. With a remote, web-based management interface, it is ideal to support advanced content distribution, real-time signal conversion and transmission for any headend system. On-board PSIP Generation/Re-branding.



KEY FEATURES

Input

- 8-VSB RF input support
- Supports ASI and TS-IP input and redundancy

Data Processing

- Two separate common interfaces support multi-channel descrambling
- PID filtering, PCR re-mapping and filling (VBR/CBR)
- PSI/SI processing and regeneration
- Supports TS & Service multiplexing
- Supports TS & EIT pass-through

Output

- MPEG2 or MPEG4 HD/SD video decoding
- HDMI, SD/HD SDI and CVBS output
- SDI output with 2 embedded audios
- 1 audio decoding through AES/EBU digital audio output, 2 pairs of balanced and unbalanced analog audio outputs
- Multicast and unicast broadcasting in LAN and WAN network
- GPI alarm and cue tone output
- 8-VSB RF Output
- Failover Slate on input loss

Management

- 1 Ethernet 10/100Base-TX, RJ45
- Web-based user interface
- Front panel keypad and LCD
- SNMP supported for system integration

SPECIFICATIONS

AC Power Input

Voltage	100 - 240 VAC
Power Consumption	Approximately. 40W
Frequency	50 - 60 Hz

Management

Connector Type	RJ45 10/100 Mbps, Auto-Sensing
Protocols	HTTP and SNMP
User Interface	WEB GUI and Front Panel
Firmware Updates	Via Web GUI

8VSB Input

Frequency Range	57 – 803 MHz
Broadcast Channels	2 – 69
Impedance	75 Ohms
Connector Type	'F' Female
RF Bandwidth	6 MHz
RF Sensitivity	-83 to 8 dBm

8VSB Output

Frequency Range	44 – 850 MHz
Frequency Step Size	1KHz
Frequency Accuracy	< ± 2 ppm
Frequency Stability	< ± 2 ppm
Output Level	-20 to 0 dBm
Impedance	75 Ohms
Connector Type	'F' Female
Spurious Output	-60 dBc

ASI I/O

Connector Type	4 BNC, 75 Ohm (2 input, 2 output)
Max Bitrate	100 Mbps
Packet Type	188 or 204 byte
Input Mode	Burst or byte
Output Mode	Burst

MPEG over IP I/O (Optional)

Connector Type	RJ45, single Port
Speed	Up to 1000Mbps
Package Format	UDP & RTP
Traffic Type	Unicast and Multicast
FEC	ProMPEG CoP3v2
TCP/IP Protocol	IPv4
IGMP	V1, 2 and 3

Fail-Over Slate (Optional)

Upon signal lost, the unit will automatically change its input selection for Fail-Over (slate)

PSIP Update

Station Identification	Up to seven letters
Transport Stream ID	TSID
Major Channel Number	#2 – 69
Minor Channel Number	#0 – 9

Mechanical

Size	19" x 1.7" x 17.3" (485 x 340 x 45mm)
Rack Space	1RU
Weight	12 pounds (5.5 Kg)

Environmental

Operating Temperature	0° to 50° C
Storage Temperature	-40° to 70° C
Humidity	95%, Non-Condensing

AAT-P1000

Media Gateway Platform

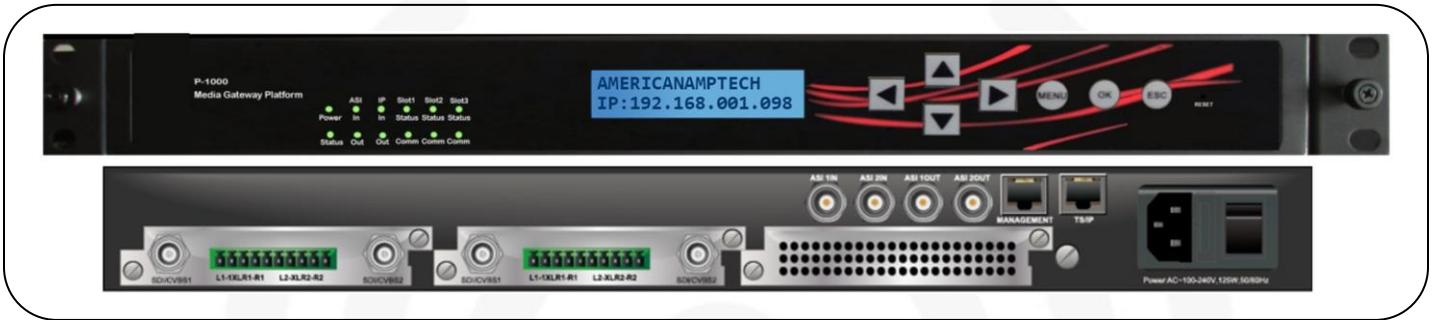

ABOUT

The P-1000 is American Amplifier Technologies high-value product for medium and small sized service operators. It provides proven headend technology in a compact, 1RU chassis. With over 30 different input and output module options that can be combined as needed, it offers a true, comprehensive video delivery solution. Whether it is for multiplexing, receiving, encoding, transcoding, modulating, scrambling or descrambling applications, the P-1000 provides the perfect combination of capacity, flexibility, and reliability at an affordable price point.

KEY FEATURES

- Any input to any output capability
- Compact and modular design: 1RU with up to 3 modules
- Embedded ASI and IP interfaces in the main chassis
- Supports up to 4Gbps video multiplexing and TS stream multiplexing/grooming
- Supports EIT multiplexing (optional) and EPG/SI insertion (both DVB and ATSC standard)
- Dual, redundant power supplies (optional)
- Easy upgrades to support new technologies by swapping modules
- Low power consumption and high reliability with MTBF ≥100,000 hours
- Multi-function multiplexing, receiving, encoding, transcoding, modulation and more

APPLICATIONS

Encoding/Transcoding

- Up to 12 SD or HD programs of encoding
- Up to 24 SD or 6 HD programs of transcoding
- Multi-audio MPEG/AAC/AC3 encoding Receiving/Digital-Turn-Around
- 12 channels or frequencies of DVB-S/S2/C/T/T2, ISDB-T and 8VSB receiving
- Descramble, remultiplex and pass-through to ASI, IP or RF output

Modulation

- Up to 24 channels of QAM modulating
- Up to 12 channels of OFDM/DVB-T modulating
- 8 channels of trans-modulation to QAM (from DVB-S/S2/T/T2, ISDB-T or 8VSB)

Stream Processing

- Up to 4Gbps processing (approx. 1000 programs)
- 14 ASI ports of multiplexing
- Internal multiplexing or pass-through capabilities
- EIT multiplexing (optional)
- Supports SI and EPG data insertion

SPECIFICATIONS

CHASSIS	
Capacity	4Gbps (approx.. 1000 programs)
Slot Number	3 slots
Interface	2 x ASI inputs (BNC, Female, 75Ω ports)
	2 x ASI outputs (BNC, Female, 75Ω ports)
	1 x GbE TS/IP (RJ45)
	1 x management (RJ45)

ASI (on-chassis)	
Bit-rate per Port	1 MPTS/SPTS at max. 100Mbps per port

MULTIPLEXING	
Routing	Any input to any output
Table Supported	SI/PSI/PSIP
PID Processing	Pass-through, remapping, filtering
EIT Processing	Re-multiplexing (optional) and pass-through
External Data	EPG and SI insertion

MANAGEMENT	
Hardware Interface	1 x RJ45 (100Mbps)
User Interface	LED indicators
	LCD screen
	Front panel control
	Web UI
	SNMP (monitoring only)

IP (on-chassis)	
Protocol	TS over UDP/RTP, unicast/multicast
MPEG TS	MPTS and SPTS
Channel	64 streams input and 32 streams output
Bit-rate per Port	Max. 780 Mbps (effective 650Mbps)
De-jittering	PCR
Management	IGMP V1, IGMP V2, IGMP V3
FEC	ProMPEG, input and output

PHYSICAL & ENVIRONMENTAL	
Input Voltage	90~260 VAC
Dual Power Supply	Optional
Power Consumption	Max. 60W
Chassis Dimension	19" W x 17" D x 1.75" H, 1 RU
Operating Temperature	0° C ~ 50° C
Storage Temperature	-10° C ~ 70° C
Operating Humidity	< 95%
MTBF	≥ 100,000 hours

ENCODING SAMPLE CONFIGURATIONS

- 4 SD Encoders input, MUX, RF/ASI/IP outputs
- 2 SD Encoders input, MUX, RF/ASI/IP outputs
- 3 SD/1HD Encoders input, MUX, RF/ASI/IP outputs
- 2 SD/2HD Encoders input, MUX, RF/ASI/IP outputs

CONVERSION SAMPLE CONFIGURATIONS

- RF/ASI/ input, MUX, RF/ASI/IP outputs
- ASI/IP input, MUX, RF/ASI/IP outputs
- RF/ASI/IP input, MUX, RF/ASI/IP outputs
- And more!!

AAT-4400 IRD

Professional Receiver / Decoder



OVERVIEW

The new AAT-4400 Receiver Decoder is the latest in American Amplifier Technologies long line of professional integrated receiver/decoders for distribution and monitoring applications. Latest-generation components ensure that the AAT-4400 provides the most complete feature set and the best value for a broad swath of common receiver/decoder applications. The product supports decoding of SD or HD video, encoded as HEVC, H.264 or MPEG2, as well as up to four audio services.

The additional audio handling capability makes the AAT-4400 the perfect solution for video distributors looking to meet upcoming descriptive video requirements, while continuing to support surround, stereo, and SAP services. As customer demands evolve, units purchased for SD decoding can be upgraded to HD via a simple software license, and with the included digital video output, video monitoring is as easy as finding the nearest standard consumer television or PC monitor.

With built-in ASI input/output capability, as well as available satellite and IP interfaces, the AAT-4400 is adaptable to most decoder use cases. The receiver also has a web interface accessible via all major browsers and complete control of the unit via the front panel keypad.

KEY FEATURES

- Support for All Common Video Formats
 - HEVC, H.264, MPEG2 HD, or SD video
 - All formats auto-detected and switchable on-the-fly
- Up to 4 services of audio decoding or SDI pass-through with support for all major audio formats
- Dual SD auto-switching outputs
- Built-in ASI I/O for maximum value and flexibility
- Available 8VSB/Q AM-B, IP, RF satellite and DVB-T/T2/C/C2/ISBD-T inputs
- Full complement of ancillary data output in ANC and VBI
- Closed-caption or auto-scaling subtitle overlays for monitoring or burn-in applications
- Intuitive, straightforward web interface
- Full control, status, and alarm monitoring via SNMP

APPLICATIONS

- **Turn-around and Back-haul Distribution Feeds**
Receive network and live feeds via RF, ASI or IP, and simultaneously demodulate, de-encapsulate, encapsulate, and decode for local processing and re-encode requirements.
- **Upgrade Existing Installations**
Replace existing receiver decoders to meet emerging video distribution challenges, including the need for more audio services or the transition to HEVC Experience industry-leading ease of use and interoperability coupled with low cost of ownership.
- **Monitor Any Video Feed**
Leverage quick set-up and automatic, decode-anything operation to monitor video feeds operationally or in an engineering lab.

SPECIFICATIONS

Professional Receiver/Decoder AAT-4400

AVAILABLE VIDEO DECODER MODULES

ASI I/O, SDI and Analog Outputs, Discrete Audio, Genlock Support
 ASI I/O, SDI and Analog Outputs, Discrete Audio
 ASI I/O, SDI Outputs, and Genlock Support
 ASI I/O and SDI Outputs

Additional Discrete Interfaces (available on AAT44041 and 44040)

Composite Video Output: 1x 75Ω BNC
 NTSC, PAL-B/G/I/D/M/N
 AES Audio Outputs: 4x 75Ω BNC
 Analog Audio Outputs: 2x 15 pin D-Sub (4 Stereo Services)
 4x XLR Breakout Cable Available
 4x BNC Breakout Cable Available
 Terminal Block Cable Available

Genlock Interface (available on AAT44041 and 44001)
 Genlock Input: 1x 75Ω BNC

COMMON VIDEO DECODER FEATURES

Base Decoding (SD 4:2:0)

Video Profile/Levels: MPEG2 MP@ML
 H.264 up to MP@L3

HEVC Decode License

Enables HEVC Decoding: Requires AAT44265 Option

HD Decoding License

Additional Profile/Levels: MPEG2 MP@HL
 H.264 up to HP@L4.2
 HEVC up to MP@MT L4 (with License)
 Additional Output Formats: 1920x1080i @ 25, 29.97, 30
 1920x1080p @ 23.97, 24, 25, 29.97, 30
 1280x720p @ 50, 59.94, 60

Additional Base Video Features

Frame Synchronization Modes: PCR-Recovered Clock
 Genlock Reference (If Supported)
 Aspect Ratio Conversion
 Manual Selection: Letterbox, Center-Cut, Anamorphic
 Automatic Selection: Follows AFD Codes

Output Formats: 720x576i @ 25
 720x480i @ 29.97

Output Interfaces:

SD/HD-SDI: 2x 75Ω BNC
 SDI Format Support: Determined by Decode License
 Digital Video: 1x HDMI-type Connector

Simultaneous SD Video Output Module

Mirrored SD SDI Outputs: 2x 75Ω BNC
 Composite Video Output: 1x 75Ω BNC
 NTSC, PAL-B/G/I/D/M/N

Simultaneous SD Video Output Module with Genlock

Mirrored SD SDI Outputs: 2x 75Ω BNC
 Composite Video Output: 1x 75Ω BNC
 NTSC, PAL-B/G/I/D/M/N

HEVC Decoding Daughter Board

Enables HEVC Licensing: Requires AAT44765 License for decoding functionality

Video Overlay Support

Closed Caption Overlays: CEA-608, CEA-708, or SCTE-20
 DVB-Subtitle Overlays: HD/SD with Auto Scaling (EN 300743)

Base Audio Decoding Features

Number of Audio Services: 2 Standard, Up to 4 Available
 Audio Codecs Supported: Dolby Digital (AC-3) & Plus (EAC-3)
 AAC-LC, HE-AAC, & HE-AACv2
 MPEG1L2 & MPEG2L2
 Linear PCM & Dolby E (Pass-through)
 Output Formats: Digital Pass-through
 PCM (Downmixed for 5.1 Sources)
 Analog (Downmixed for 5.1 Sources)

Discrete Channel Audio Output License

Adds Output Formats: PCM (Decoded Discrete channels for 5.1 Sources)
 Analog (Decoded Discrete channels for 5.1 Sources)

4 Service Audio Decode License

Additional Audio Services: 2 Services (Total of 4 Services)

Base Audio Output Features

SDI Embedded Audio Output: 4 Audio Pairs

Ancillary Data Support

SDI ANC Data Types: AFD (SMPTE 2016)
 Closed Captions (CEA-708)
 OP-47 (SMPTE RDD-08)
 SMPTE RDD-11
 SCTE 127 (SMPTE 2031)
 EN301775 (SMPTE 2031)
 Time Code (SMPTE 12M-2)
 SCTE 104 (SMPTE 2010 with License)
 VBI Waveforms (SDI/Composite): Line 21 Captions (CEA-608)
 TVG2X, AMOL-48/96 (SCTE-127)
 Teletext/WSS/VPS (EN301775)

SCTE 35 to SCTE 104/Relay Output License

Cablelabs ESAM POIS Interface License

Included Transport Stream Input/Output Features

ASI Input/Output: 2 x 75Ω BNC (selectable in/out)
 Supported Bitrate: 250 Kbps to 200 Mbps

BISS Descrambling License

Supported Modes: Mode 1, Mode E, Injected ID
 Multi-BISS Support: Up to 12 Separate Keys

DVB-CI Multi-Service License

With DVB-CI Module: Enables Multi-service Descrambling

PID/Service Filtering License

Filtering: 10 Independent TS (MPTS or SPTS) created; output via IP or ASI

Table Regeneration (DVB Mode): PAT regeneration
 Table Pass-through (DVB Mode): PMT, CAT, NIT pass-through Table
 Regeneration (DVB Mode): PAT, SDT
 Table Pass-through (DVB Mode): PMT, CAT, NIT, EIT, RST, TDT, TOT

SPECIFICATIONS CONTINUED

Professional Receiver/Decoder AAT-4400

AAT

8VSB/QAM-B INPUT MODULE AAT44101

Physical Interface:	75Ω F-Type
Frequency Range:	50-1000 MHz
Sensitivity:	-34 to +40 dBmV (A74 Compliant)
8VSB Standard:	ATSC A/53E
8VSB Channel Plans:	Broadcast
QAM Standard:	ITU Annex B/SCTE DVS-031
QAM Channel Plans:	FCC, IRC, HRC
QAM Constellations:	QAM64, QAM25

DVB-CI DESCRAMBLING MODULE AAT44421

Physical Interface:	Adds two DVB-CI CAM Slots
Without Multi-Service License:	Descrambles Decoded Service Only
With Multi-Service License:	Number of Services limited by CAM

IP INPUT/OUTPUT MODULE AAT44127

Physical Interface:	2x RJ45, 10/100/1000 Auto-Negotiate
Input Format:	UDP or RTP Constant Bitrate or Null-Stripped RTP Header Extensions Supported SMPTE 2022/CoP3 FEC Supported
Output Format:	UDP, RTP (with License)
MPE De-encapsulation:	Up to 2 PIDs Up to 60Mbps per MPE PID
IP Encapsulation:	1 to 7 TS Packets per IP Packet
Addressing:	Unicast or Multicast
IGMP compatibility:	Version 1, 2 & 3
Per TS Bitrate:	250 Kbps to 200 Mbps

MPEG/IP FEC Output License	AAT44925
Additional Output Formats:	RTP and Header Extensions SMPTE 2022/CoP3 FEC Supported

DVB-S/S2 INPUT MODULE AAT44116

Physical Interface:	4x 75Ω F-Type
Frequency Range:	950-2150 MHz
Symbol Rates:	1-60 Msps
DVB-S Modulation Modes:	QPSK (All FEC Rates)
DVB-S2 Modulation Modes:	QPSK/8PSK (All FEC Rates) 16/32APSK with License
LNB Power:	Off/13/14/18/19VDC @ 450mA
Control Tone Support:	22 kHz On/Off
Supported Roll-off Factors:	0.35, 0.25, 0.20, 0.15, 0.10, 0.05

DVB-S2 Advanced Feature License	AAT44916
Additional Modulation Modes:	16ASPK/32APSK (All FEC Rates) VCM Demodulation Support Multistream Support (Single ISI)

BROADCOM TURBOPSK INPUT MODULE AAT44111

Physical Interface:	1x 75Ω F-Type
Frequency Range:	950-2150 MHz
Symbol Rates:	1-30 Msps
DVB-S Modulation Modes:	QPSK (All FEC Rates)
TurboPSK Modulation Modes:	QPSK /8PSK (All FEC Rates)

DVB-T/T2/C/C2/ISDB-T INPUT MODULE AAT44115

Physical Interface:	1x 75Ω F-Type
Frequency Range:	42-1002 MHz
Bandwidth:	1.7MHz, 5 MHz, 6MHz, 7MHz, 8MHz
Constellations:	
DVB-T:	QPSK, QAM16, QAM64 (All FEC Rates)
DVB-T2:	QPSK, QAM16, QAM64, QAM256 (All FEC Rates)
DVB-C:	QAM16, QAM32, QAM64, QAM128, QAM256 (All FEC Rates)
DVB-C2:	QAM16, QAM64, QAM256, QAM1024, QAM4096 (All FEC Rates)
ISDB-T:	QPSK, QAM16, QAM64 (All FEC Rates)

MANAGEMENT

Connector:	RJ-45 10/100 - Auto Negotiating
Protocols:	HTTP and SNMP
User Interfaces:	Full control via web GUI Full control via front panel
Automation Interfaces:	Full status and control via SNMP Configurable SNMP traps Web services API available Syslog message logging
Firmware Updates:	Via Web GUI

DIMENSIONS/POWER

Height:	1 RU, 1.72" (44 mm)
Width:	1 RU, 17.2" (437 mm)
Depth:	14.6" (370 mm)
Power:	100-240 VAC 50/60 Hz 36-72 VDC
Supply Options:	Single AC Power Supply (Standard) Dual AC Power Supply Single DC Power Supply

ENVIRONMENTAL CONDITIONS

Operating Temp:	0° to 50°C
Storage Temp:	-40°C to 65°C
Relative Operating Humidity:	<95% (non-condensing)

AAT-P160 IRD

Integrated Receiver / Decoder



OVERVIEW

The TP160-IRD is a powerful and cost-effective broadcast level decoder. It supports signal receiving, multi-channel descrambling, PID filtering, and IP or ASI stream outputs. It also supports MPEG-2/H.264 SD/HD program decoding to HDMI, SDI and CVBS with dual audio PID decoding. By utilizing a remote, web-based management interface, it is ideal to support advanced content distribution, real-time signal conversion and transmission for any video delivery system.

ORDERING INFORMATION

Unit	Features
P160 IRD	MPEG-2/H.264 SD/HD decoding with HDMI, SDI and CVBS
	DVB-S/S2 input, ASI and IP I/O
	Genlock
	Full closed caption embedding

KEY FEATURES

Receiving and Input

- Includes a standard DVB-S/S2 RF input with loop-thru output
- Supports DVB-S2 multi-stream receiving (optional)
- Supports ASI and IP input and redundancy
- Genlock input for studio synchronization

Data Processing

- Two DVB-CI CAM slots support multi-channel descrambling and are compliant with various popular CAS systems
- Embedded BISS-1 & BISS-E support TS & Service level descrambling (optional license)
- PID filtering capabilities
- Full 608/708 caption decoding and embedding

Output

- MPEG-2 and H.264 SD and HD video decoding
- HDMI, SD/HD-SDI and CVBS video outputs
- SDI outputs capable of two embedded PCM audios
- One PCM audio output via AES/EBU digital audio connector
- Two pairs of balanced and unbalanced analog audio outputs
- Multicast or unicast TS-IP output
- GPI alarm output

Management

- 1 Ethernet 10/100Base-TX, RJ45
- Web-based user interface
- Front panel keypad and LCD
- SNMP supported for system integration

SPECIFICATIONS

DVB-S/S2 INPUT

Input	1xRF, F-type, 75Ω
Constellation	QPSK, 8PSK
Symbol Rate	1~45 Msps
Input Frequency	950~2150 MHz
Max Bit-rate	150Mbps
Signal Level	-65~-25 dBm
LNB PS	DC 13/18V
22K Switch	On/off

TS-IP

Interface	GbE level RJ45 port
Speed	Up to 1000Mbps
Package Format	UDP & RTP (auto detection)
Traffic Types	Unicast or multicast
IGMP	V2, V3
FEC	ProMPEG CoP3v2
TCP/IP Protocol	IPv4

ASI

Interface	4 BNC, 75Ω (2xASI input, 2xASI output)
Max Bit-rate	100Mbps
Packet Type	188/204 bytes
Input Mode	Byte and burst
Output Mode	Byte burst

DE-SCRAMBLING

DVB Common Interface	2 slots
Bit-rate	Max 100Mbps
CAM Supported	NEOTION, SMIT, ASTON and other major CAMs
CAS Supported	CONAX, IRDETO, Novel-Super TV, CTI and other CAS
BISS 1& BISS E	TS & Program level

VIDEO DECODING

Decoding Format	MPEG-2 SD 4:2:0 MP@ML
	MPEG-2 HD 4:2:0 MP@ML
	H.264 AVC SD MP@L3
	H.264 AVC HD MP@L4.0/HP@4.0

AUDIO DECODING

Audio Format	MPEG1 Layer II
	Dolby Digital (AC-3)
	Dolby Digital Plus (E/AC-3)
	AAC (MPEG2, MPEG4/HE v1, 2, MPEG4/LC)
Adjustable Volume Level	-63~0 dB

CAPTIONS

CEA-608 and	CVBS Line 21 (608)
CEA-708 Supported	SD-SDI digitized Line 21 (608)
Embedding	SD/HD-SDI VANC (608 and 708)

PHYSICAL & ENVIRONMENTAL

Input Voltage	100 ~ 240 VAC
Power Consumption	Approx. 40W
Rack Space	1 RU
Dimensions (WxHxD)	19"x1.7"x17.3"
Operating Temperature	0 °C to 50 °C
Storage Temperature	-10 °C to 70 °C
Operating Humidity	< 95% non-condensing
MTBF	>150,000 hours

AAT-DVM-1903ML 8VSB Modulator

8VSB Digital Modulator



The DVM-1903ML 8-VSB modulator is a professional performing product based on the 8-VSB (ATSC) modulation. It shows superior quality to modulate MPEG transport stream as DVB-ASI signal to 8-VSB(ATSC) and output as suitable frequency band for digital broadcasting transmission. Also, it is very easy to control with high class front VFD.

- Retain your viewer with optimized modulator for ATSC(8-VSB)
- Excellent coding as ITU-T(J.83) Annex D
- Cost reduction for installing with simple set-up and operation
- Stable output with Hybrid AMP integrated
- Secure more space with compact and light weight design
- ASI input transport stream
- Excellent RF output
- Supports 8-VSB(ATSC) modulation
- User adjustable output level and frequency
- Front panel control
- PCR Jitter: $\leq \pm 200$ ns
- Group Delay as ± 20 ns
- Phase Noise VHF -105 dB@20KHz, UHF -103 dB@20KHz
- Frequency: 54 ~ 870MHz
- Output Level: 55 \pm 5 dBmV
- Spurious: ≤ -63 dB
- MER After Equalizer: 42dB
- Highly Advanced fine-tuning

SPECIFICATIONS

Digital Input

Transport Stream	DVB-ASI
Connector	BNC (75 Ω)
Coding	ITU-T (J.83) Annex D
Bit Rate	19.393 Mbps
Packet Format	188 Byte
Symbol Rate	10.762 Msymbol/s
Modulation	8-VSB

RF Output

Frequency Range	54~870 MHz
Impedance	75 Ω
Output Level	55±5dBmV
Level Control Range	0~-15dB
Bandwidth	6 MHz
MER After Equalizer	42 dB
MER Before Equalizer	37 dB
Phase Noise	VHF -105 dB@20KHz VHF -103 dB@20KHz
Adjacent Channel Carrier Attenuation Characteristic	≥ 45 dB (Out-of-band)
Spurious	≤ -63 dB
Return Loss	≥ 17 dB
Group Delay	±2 0ns
Frequency Response	±0.5 dB
Frequency Tolerance	±2ppm
PCR Jitter	≤ ± 200 ns

General

Power Requirements	AC 90~230V, 50/60Hz
Power Consumption	13W
Weight	3Kg
Dimensions	482 x 44 x 383 mm

Options

DVM-1903ML ATSC(8-VSB) Modulation
DOM-1903ML OAM (Annex A, B and C)
Modulation DTM-1903ML DVB-T/T2
Modulation

CONFIGURATIONS

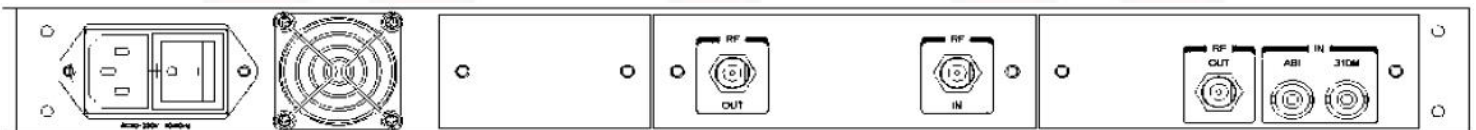

Bandpass Filters and Combiner Systems

AAT broadcast filters and combiners are designed using a high quality aluminum iris coupled cavity. Excellent for analog and digital operations. 1 kW through 60 kW systems available.

Features:

- FM Frequency 87.5 - 108 MHz, UHF Frequency 470 – 860 MHz, VHF I & VHF III Band
- High quality aluminum, brass, and copper materials.
- Iris coupled design, perfect for analog or digital applications.
- Available in floor, ceiling, and wall mount configurations.
- No finger stock used
- Cross Coupled

FM Bandpass Filters

Features



- 88 – 108 MHz
- High-Quality Aluminum, Brass, and Copper Materials
- Floor, Ceiling, or Wall-Mount Configurations
- No Finger Stock Used
- Cross Coupled



Specifications:

Frequency Range	88 – 108 MHz
Input Power Rating	1 kW – 60 kW
Insertion Loss	Model & Size Dependent
Cooling Method	Convection or Forced Air
Rejection	-20 dB 1.0 MHz -40 dB 2.0 MHz
Group Delay	100 ns 200 KHz Typical
Connections and Adapters	Type N, 7/16 DIN, EIA Flange

*Notches Provide > 40 dB rejection or better

Standard Models:

Model	Power Rating	2-Pole		3-Pole		4-Pole	
BP-IR-1K	1 kW	4" x 8" x 46"	32 lbs.	4" x 12" x 46"	48 lbs.	4" x 16" x 46"	65 lbs.
BP-IR-1.5K	1.5 kW	4" x 8" x 46"	35 lbs.	4" x 12" x 46"	52 lbs.	4" x 16" x 46"	70 lbs.
BP-IR-3K	3 kW	6" x 12" x 46"	75 lbs.	6" x 18" x 46"	115 lbs.	6" x 24" x 46"	150 lbs.
BP-IR-7K	7 kW	8" x 16" x 46"	100 lbs.	8" x 24" x 46"	150 lbs.	8" x 32" x 46"	200 lbs.
BP-IR-12K	12 kW	12" x 24" x 56"	150 lbs.	12" x 36" x 56"	225 lbs.	12" x 48" x 56"	300 lbs.
BP-IR-20K	20 kW	17" x 34" x 56"	170 lbs.	17" x 51" x 56"	255 lbs.	17" x 68" x 56"	340 lbs.
BP-IR-40K	40 kW	22" x 44" x 56"	350 lbs.	22" x 66" x 56"	525 lbs.	22" x 88" x 56"	700 lbs.
BP-IR-60K	60 kW	25" x 50" x 56"	375 lbs.	25" x 75" x 56"	575 lbs.	25" x 100" x 56"	825 lbs.

*Operating Altitude: Ratings are based on elevations up to 2800'. De-rating begins after 2800'.

Disclaimer: Specifications are subject to change without notice. Information may be changed or updated without notice. American Amplifier Technologies™ may also make improvements and/or changes in the products and/or pricing described at any time without notice.

FM Bandpass Filters

MODEL	DESCRIPTION
BP-IR-2-1K	1 KW 2-cavity Bandpass Filter
BP-IR-3-1K	1 KW 3-cavity Bandpass Filter
BP-IR-4-1K	1 KW 4-cavity Bandpass Filter
BP-IR-2-1.5K	1.5 KW 2-cavity Bandpass Filter
BP-IR-3-1.5K	1.5 KW 3-cavity Bandpass Filter
BP-IR-4-1.5K	1.5 KW 4-cavity Bandpass Filter
BP-IR-2-3K	3KW 2-cavity Bandpass Filter
BP-IR-3-3K	3KW 3-cavity Bandpass Filter
BP-IR-4-3K	3KW 4-cavity Bandpass Filter
BP-IR-2-7K	7KW 2-cavity Bandpass Filter
BP-IR-3-7K	7KW 3-cavity Bandpass Filter
BP-IR-4-7K	7KW 4-cavity Bandpass Filter
BP-IR-2-12K	12KW 2-cavity Bandpass Filter
BP-IR-3-12K	12KW 3-cavity Bandpass Filter
BP-IR-4-12K	12KW 4-cavity Bandpass Filter
BP-IR-2-20K	20KW 2-cavity Bandpass Filter
BP-IR-3-20K	20KW 3-cavity Bandpass Filter
BP-IR-4-20K	20KW 4-cavity Bandpass Filter
BP-IR-2-40K	40KW 2-cavity Bandpass Filter
BP-IR-3-40K	40KW 3-cavity Bandpass Filter
BP-IR-4-40K	40KW 4-cavity Bandpass Filter
BP-IR-2-60K	60KW 2-cavity Bandpass Filter
BP-IR-3-60K	60KW 3-cavity Bandpass Filter
BP-IR-4-60K	60KW 4-cavity Bandpass Filter

FM Bandpass Filters with Cross-Coupled Notch

MODEL	DESCRIPTION
BP-IR-2-1K-N	1 KW 2-cavity Bandpass Filter with Notch
BP-IR-3-1K-N	1 KW 3-cavity Bandpass Filter with Notch
BP-IR-4-1K-N	1 KW 4-cavity Bandpass Filter with Notch
BP-IR-2-1.5K-N	1.5 KW 2-cavity Bandpass Filter with Notch
BP-IR-3-1.5K-N	1.5 KW 3-cavity Bandpass Filter with Notch
BP-IR-4-1.5K-N	1.5 KW 4-cavity Bandpass Filter with Notch
BP-IR-2-3K-N	3KW 2-cavity Bandpass Filter with Notch
BP-IR-3-3K-N	3KW 3-cavity Bandpass Filter with Notch
BP-IR-4-3K-N	3KW 4-cavity Bandpass Filter with Notch
BP-IR-2-7K-N	7KW 2-cavity Bandpass Filter with Notch
BP-IR-3-7K-N	7KW 3-cavity Bandpass Filter with Notch
BP-IR-4-7K-N	7KW 4-cavity Bandpass Filter with Notch
BP-IR-2-12K-N	12KW 2-cavity Bandpass Filter with Notch
BP-IR-3-12K-N	12KW 3-cavity Bandpass Filter with Notch
BP-IR-4-12K-N	12KW 4-cavity Bandpass Filter with Notch
BP-IR-2-20K-N	20KW 2-cavity Bandpass Filter with Notch
BP-IR-3-20K-N	20KW 3-cavity Bandpass Filter with Notch
BP-IR-4-20K-N	20KW 4-cavity Bandpass Filter with Notch
BP-IR-2-40K-N	40KW 2-cavity Bandpass Filter with Notch
BP-IR-3-40K-N	40KW 3-cavity Bandpass Filter with Notch
BP-IR-4-40K-N	40KW 4-cavity Bandpass Filter with Notch
BP-IR-2-60K-N	60KW 2-cavity Bandpass Filter with Notch
BP-IR-3-60K-N	60KW 3-cavity Bandpass Filter with Notch
BP-IR-4-60K-N	60KW 4-cavity Bandpass Filter with Notch

FM Combiner Systems

Features:

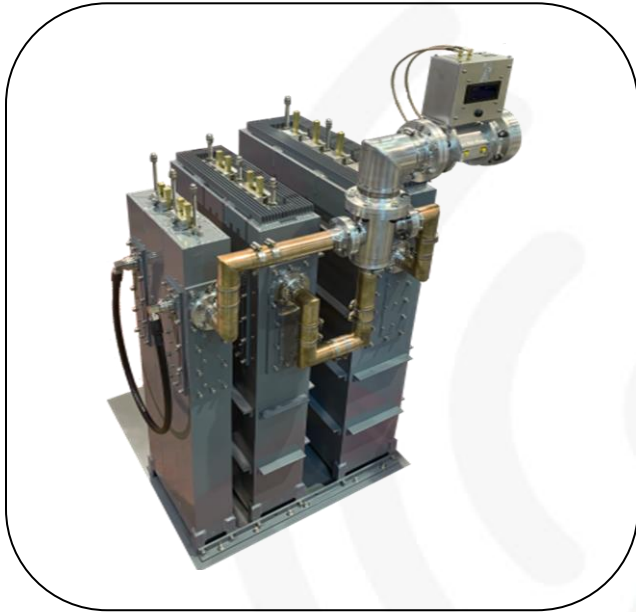

- 88 – 108MHz
- Branch or Constant Impedance Systems
- Iris Coupled Design
- Floor, Ceiling, or Wall-Mount Configurations
- No Finger Stock Used
- High-Quality Aluminum, Brass, and Copper Materials



Specifications:

Frequency	88 – 108 MHz
Input Power Rating	1 kW – 60 kW
Cooling Method	Convection or Forced Air
Rejection	> -50 dB
Group Delay	100 ns 200 KHz
Connections and Adapters	EIA Flange, Type N, 7/16 DIN

*Cross Coupled Notch required for <2 MHz Frequency spacing

Standard Models:

Branch Models	Output Rating	2-Channel		3-Channel		4-Channel	
C-IR-BR-FM-K	2 kW	8" x 14" x 46"	150 lbs.	12" x 12" x 46"	210 lbs.	16" x 12" x 46"	340 lbs.
C-IR-BR-FM-K	6 kW	8" x 14" x 46"	150 lbs.	12" x 12" x 46"	210 lbs.	16" x 12" x 46"	340 lbs.
C-IR-BR-FM-K	14 kW	15" x 24" x 56"	310 lbs.	36" x 24" x 56"	480 lbs.	48" x 24" x 56"	600 lbs.
C-IR-BR-FM-K	60 kW	56" x 76" x 56"	850 lbs.	88" x 76" x 56"	1550 lbs.	120" x 76" x 56"	2200 lbs.

Constant Impedance	Output Rating	2-Channel		3-Channel		4-Channel	
C-IR-CI-FM-K	7 kW	14" x 24" x 46"	350 lbs.	30" x 24" x 46"	700 lbs.	44" x 24" x 46"	1000 lbs.
C-IR-CI-FM-K	14 kW	18" x 18" x 46"	450 lbs.	40" x 18" x 46"	900 lbs.	62" x 18" x 46"	1500 lbs.
C-IR-CI-FM-K	60 kW	45" x 40" x 56"	800 lbs.	100" x 40" x 56"	1750 lbs.	160" x 40" x 56"	2600 lbs.
C-IR-CI-FM-K	120 kW	50" x 66" x 56"	900 lbs.	110" x 66" x 56"	2100 lbs.	170" x 66" x 56"	3100 lbs.

*Models and configurations vary based on the circuit requirement. Please contact the factory for the specific circuit requirement.

Disclaimer: Specifications are subject to change without notice. Information may be changed or updated without notice. American Amplifier Technologies™ may also make improvements and/or changes in the products and/or pricing described at any time without notice.

UHF TV Combiner Systems



Features

- Frequency: 470 – 860 MHz
- Cross Coupled Modules
- High Quality Aluminum, Brass, and Copper Materials
- Digital or Analog Systems
- No Finger Stock
- 6 MHz, 7 MHz, or 8 MHz Bandwidth
- Non-Critical and Critical Mask Type

Specifications:

Frequency	470 – 860 MHz	Connections Available:	EIA Flange, 7/16" DIN
Input Power Rating	1 kW – 24 kW		
Cooling Method	< 0.8 dB Typical		
Rejection	Convection, Forced Air, Liquid		
Group Delay	> 50 dB		
Connections and Adapters	<350 ns		

Standard Models:

Model	Input Power Rating (digital)	Output Power Rating (digital)	6 Section Modules		8 Section Modules		
UHF-C-1K	500 W	1 kW	24" x 12" x 12"	20 lbs.	30" x 12" x 12"	52 lbs.	<i>UHF-C-1K</i>
UHF-C-3K	1.5 kW	3 kW	30" x 18" x 18"	80 lbs.	38" x 18" x 18"	230 lbs.	<i>UHF-C-3K</i>
UHF-C-6K	3 kW	6 kW	30" x 18" x 18"	85 lbs.	38" x 18" x 18"	240 lbs.	<i>UHF-C-6K</i>
UHF-C-12K	6 kW	12 kW	32" x 18" x 18"	100 lbs.	40" x 18" x 18"	270 lbs.	<i>UHF-C-12K</i>
UHF-C-24K	12 kW	24 kW	35" x 19" x 30"	220 lbs.	43" x 19" x 30"	550 lbs.	<i>UHF-C-24K</i>

Operating Altitude Ratings are based on elevations up to 2800'. Derating begins after 2800'

Low Pass Filters

1 kW – 60 kW Modules



- Frequency: VHF I, II, III, UHF IV, V
- High quality aluminum, brass, and copper materials.
- Available in floor, ceiling, rack-mount, and wall mount configurations.

Specifications:

Frequency	VHF I, II, III UHF IV, V	Connections Available:	Type N, 7/16 DIN, EIA Flange
Input Power Rating	1 KW thru 60 KW	Adapters Available:	Type N, 7/16 DIN, EIA Flange
Insertion Loss	0.18 dB or better		
Cooling Method	Convection or Forced Air		
Rejection	>40dB		
Group Delay	50 ns or better on channel		

Standard Models:

Model	Power Rating
LP-1K	1 KW
LP-2K	2 KW
LP-5K	5 KW
LP-12K	12 KW
LP-20K	20 KW
LP-30K	30 KW
LP-40K	40 KW
LP-60K	60 KW

TV UHF & VHF Band 1 & Band 2 Low Pass Filters: Contact the factory for proposals and information

Email: sales@americanamptech.com

Phone: 916-978-1899

UHF Mask Filters

Features:



- 470 – 860 MHz
- Cross Coupled
- No Finger Stock
- Non-Critical and Critical Mask Type
- High Quality Aluminum, Brass, and Copper Materials



Specifications:

Frequency	470 – 860 MHz
Input Power Rating	500 W – 24 kW
Insertion Loss	< 0.8 dB Typical
Cooling Method	Convection, Forced Air, Liquid
Rejection	> 50 dB
Group Delay	300 ns Typical
Connections Available	EIA Flange, 7/16" DIN

Standard Models:

Model	Power Rating (digital)	6 Section System		8 Section System	
		Dimensions	Weight	Dimensions	Weight
UHF-M-1K	1 kW	15" x 10" x 7"	41 lbs.	20" x 10" x 7"	58 lbs.
UHF-M-2K	2 kW	24" x 16" x 8"	83 lbs.	32" x 16" x 8"	102 lbs.
UHF-M-3K	3 kW	24" x 16" x 8"	86 lbs.	32" x 16" x 8"	123 lbs.
UHF-M-5K	5 kW	25" x 18" x 8"	110 lbs.	34" x 18" x 8"	135 lbs.
UHF-M-7K	7 kW	30" x 16" x 15"	173 lbs.	40" x 16" x 15"	295 lbs.
UHF-M-12K	12 kW	35" x 24" x 50"	534 lbs.	35" x 24" x 60"	723 lbs.

*Operating Altitude: Ratings are based on elevations up to 2800'. Derating begins after 2800'

Disclaimer: Specifications are subject to change without notice. Information may be changed or updated without notice. American Amplifier Technologies™ may also make improvements and/or changes in the products and/or pricing described at any time without notice.

UHF Mask Filters

MODEL	DESCRIPTION
UHF-M-6-1K	6-pole 1 kW UHF Mask Filter
UHF-M-6-2K	6-pole 2 kW UHF Mask Filter
UHF-M-6-3K	6-pole 3 kW UHF Mask Filter
UHF-M-6-5K	6-pole 5 kW UHF Mask Filter
UHF-M-6-7K	6-pole 7 kW UHF Mask Filter
UHF-M-6-14K	6-pole 14 kW UHF Mask Filter
UHF-M-8-1K	8-pole 1 kW UHF Mask Filter
UHF-M-8-2K	8-pole 2 kW UHF Mask Filter
UHF-M-8-3K	8-pole 3 kW UHF Mask Filter
UHF-M-8-5K	8-pole 5 kW UHF Mask Filter
UHF-M-8-7K	8-pole 7 kW UHF Mask Filter
UHF-M-8-14K	8-pole 14 kW UHF Mask Filter

VHF Band I & III Mask Filters

Features:



- VHF Band I & Band III
- Cross Coupled
- No Finger Stock Used
- High-Quality Aluminum, Brass, and Copper Materials



Specifications:

Band	VHF I & VHF III
Input Power Rating	1.5 kW – 30 kW
Insertion Loss	< 0.35 dB
Cooling Method	Convection or Forced Air
Rejection	> 50 dB
Group Delay	< 300 ns Typical
Connections Available	EIA Flange

Disclaimer: Specifications are subject to change without notice. Information may be changed or updated without notice. American Amplifier Technologies™ may also make improvements and/or changes in the products and/or pricing described at any time without notice.

VHF Band I & III Mask Filters

MODEL	DESCRIPTION
VHFI-M-6-2K	6-pole 2 kW VHFI Mask Filter
VHFI-M-6-5K	6-pole 5 kW VHFI Mask Filter
VHFI-M-6-8K	6-pole 8 kW VHFI Mask Filter
VHFI-M-6-12K	6-pole 12 kW VHFI Mask Filter
VHFI-M-6-15K	6-pole 15 kW VHFI Mask Filter
VHFI-M-8-2K	8-pole 2 kW VHFI Mask Filter
VHFI-M-8-5K	8-pole 5 kW VHFI Mask Filter
VHFI-M-8-8K	8-pole 8 kW VHFI Mask Filter
VHFI-M-8-12K	8-pole 12 kW VHFI Mask Filter
VHFI-M-8-15K	8-pole 15 kW VHFI Mask Filter
VHFIII-M-6-2K	6-pole 2 kW VHFIII Mask Filter
VHFIII-M-6-5K	6-pole 5 kW VHFIII Mask Filter
VHFIII-M-6-8K	6-pole 8 kW VHFIII Mask Filter
VHFIII-M-6-12K	6-pole 12 kW VHFIII Mask Filter
VHFIII-M-6-15K	6-pole 15 kW VHFIII Mask Filter
VHFIII-M-8-2K	8-pole 2 kW VHFIII Mask Filter
VHFIII-M-8-5K	8-pole 5 kW VHFIII Mask Filter
VHFIII-M-8-8K	8-pole 8 kW VHFIII Mask Filter
VHFIII-M-8-12K	8-pole 12 kW VHFIII Mask Filter
VHFIII-M-8-15K	8-pole 15 kW VHFIII Mask Filter

FM Isocoupler



Features

- Provides versatility to install transmission systems on existing AM radiating antenna systems
- Frequency Range: 82 – 108 MHz

Specifications:	
Frequency	82 – 108 MHz
Power Rating	2 kW – 40 kW
Insertion Loss at Fundamental Frequency	< 0.2 dB
Input Impedance	50 ohms
Output Impedance	50 ohms
VSWR at Channel	1.05:1 or better
Connections Available	Type N, 7/16" DIN, 7/8" EIA, 1-5/8" EIA, 3-1/8" EIA, 4-1/16" EIA, 6-1/8" EIA

Standard Models:	
Model	Power Rating
ISO-FM-2K	2 kW
ISO-FM-10K	10 kW
ISO-FM-20K	20 kW
ISO-FM-40K	40 kW

Power ratings are based on elevations up to 2800'. Derating begins after 2800'

RF Isolators

190 Watt – 3200 Watt Systems



- Frequency: VHF I, II, III UHF IV, V
- Rack Mountable
- Broadband

Specifications:		
Frequency	VHF I, II, III, UHF IV, V	Connections Available: Type N, 7/16 DIN, EIA Flange
Power Rating	150 Watts thru 3,000 Watts	
Insertion Loss	>20 dB	
Cooling Method	Convection or Forced Air	
Group Delay	50 ns or better across channel	

Standard Models:	
Model	Power Rating
ISO-150	190 W
ISO-350	350 W
ISO-500	500 W
ISO-1000	1000 W
ISO-2000	2000 W
ISO-3000	3000 W

Power ratings are based on elevations up to 2800'. Derating begins after 2800'

Dummy Loads

Features



- DC – 110 MHz
- Rack Mountable (1 kW – 3 kW).
- Forced Air Cooled
- Three separate loads can be configured for RM series 3U rack mountable assembly.

Specifications:	
Frequency	DC – 110 MHz
Power	200 W – 50 kW
VSWR	1.1:1 typical
Ambient	-20 to +104 degrees F
Connections Available	Type N, 7/16" DIN, 7/8" EIA, 1-5/8" EIA, 3-1/8" EIA, 6-1/8"
Modular Rack Mountable Units	The rack mountable units can have up to three separate loads. Each load module location can be either a 1 kW, 2 kW, or 3 kW load. Three Rack Units (3U)
RM Series Weight	27 lbs.

Models:	
Model	Description and Power Ratings
DL-1K-RM	1 kW rack mountable dummy load, 3U, 120 / 220 VAC 50/60Hz
DL-2K-RM	2 kW rack mountable dummy load, 3U, 120 / 220 VAC 50/60Hz
DL-3K-RM	3 kW rack mountable dummy load, 3U, 120 / 220 VAC 50/60Hz
DL-1K-RM-Module	1 kW rack mountable load module for DL-RM units.
DL-2K-RM-Module	2 kW rack mountable load module for DL-RM units.
DL-3K-RM-Module	3 kW rack mountable load module for DL-RM units.
Note*	For users that need more than one load within one 3U rack mountable unit: Purchase the single module unit, then add the other modules to the order. A single 3U unit can have up to three load modules.
DL-5K	5 kW dummy load.
DL-10K	10 kW dummy load.
DL-25K	25 kW dummy load.
DL-50K	50 kW dummy load

Power ratings are based on elevations up to 2800'. Derating begins after 2800'

RF Power Meters

AAT RF Power Meters allow user defined parameters and provide accurate information with remote monitoring capabilities. User defined parameters allow the end user to configure the power meter to meet their specific requirements.

Available Features:

- FM, VHF & UHF Systems
- Monitoring via HDMI, Ethernet, SNMP, Remote Samples, LCD Display
- User Defined Power Range, Modulation Type, and Channel Selection
- Customizable Thresholds

PM Series RF Power Meters

Features



- AM, FM, VHF & UHF Systems
- Ethernet, SNMP, SMTP, Remote Samples
- LCD Display
- User Defined Power Range, Modulation Type, and Channel Selection
- Field Calibration Available via User Interface
- Monitor Combined System
- Multi-Unit Pairing
- Optional Remote Display Unit

Specifications:		
Frequency	VHF I, II, III, UHF IV, V	Connections Available: Type N, 7/16 DIN, EIA Flange
Power Rating	190 W thru 3200 W	
Insertion Loss	>20 dB	

Standard Models:	
Model	
PM-AM	
PM-VHFI	
PM-FM	
PM-VHFIII	
PM-UHF	



RF Power Meter Remote Display

Features



- Rack Mountable Monitoring System and Display
- Monitoring: Ethernet, SNMP, SMTP, & Remote Samples
- LCD Display
- User Defined Thresholds, Modulation Type, and Frequency Selection
- Paired with an External Directional Coupler

SPECIFICATIONS

<i>Frequency Range</i>	AM, VHF1, FM, VHFIII, UHF
<i>RF Input Connector Size</i>	SMA Female. Qty 2. Reflected and Forward Power Input Ports
<i>Power Supply Source Voltage</i>	120 VAC 60/50 Hz
<i>Power Consumption</i>	5.1 W
<i>Power Measurement</i>	Average Power
<i>Coupler EIA Sizes</i>	7/8" , 1-5/8" , 3-1/8" , 4-1/16" , 6-1/8"
<i>Remote DB Connector Size</i>	DB9 Female
<i>Ethernet Connector</i>	RJ45
<i>Model</i>	PM-RD-2U
<i>Rack Units</i>	2 RU
<i>Dimensions</i>	19" W X 12" L X 3.5" H

DRAWING & DIAGRAMS

Front Panel View



Rear Panel View

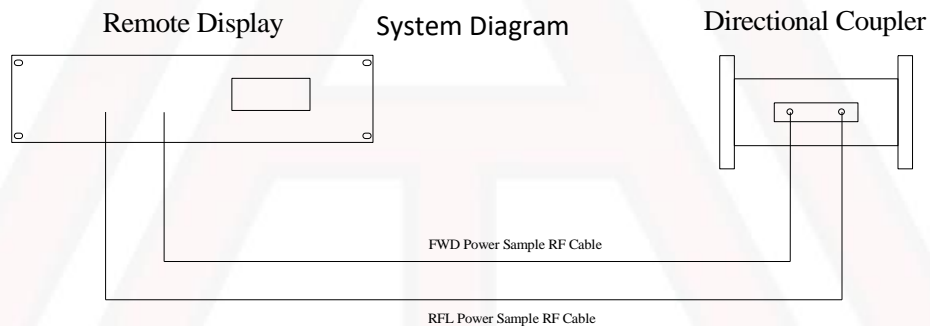

PM Series RF Power Meters

MODEL	DESCRIPTION
PM-AM-N	RF Power Meter AM Band Type N Connector
PM-FM-N	RF Power Meter FM Band Type N Connector
PM-VHFI-N	RF Power Meter VHFI Band Type N Connector
PM-VHFIII-N	RF Power Meter VHFIII Band Type N Connector
PM-UHF-N	RF Power Meter UHF Band Type N Connector
PM-AM-716	RF Power Meter AM Band 7/16" DIN Connector
PM-FM-716	RF Power Meter FM Band 7/16" DIN Connector
PM-VHFI-716	RF Power Meter VHFI Band 7/16" DIN Connector
PM-VHFIII-716	RF Power Meter VHFIII Band 7/16" DIN Connector
PM-UHF-716	RF Power Meter UHF Band 7/16" DIN Connector
PM-AM-78	RF Power Meter AM Band 7/8" EIA Connector
PM-FM-78	RF Power Meter FM band 7/8" EIA Connector
PM-VHFI-78	RF Power Meter VHFI band 7/8" EIA Connector
PM-VHFIII-78	RF Power Meter VHFIII band 7/8" EIA Connector
PM-UHF-78	RF Power Meter UHF band 7/8" EIA Connector
PM-AM-158	RF Power Meter AM Band 1-5/8" EIA Connector
PM-FM-158	RF Power Meter FM band 1-5/8" EIA Connector
PM-VHFI-158	RF Power Meter VHFI band 1-5/8" EIA Connector
PM-VHFIII-158	RF Power Meter VHFIII band 1-5/8" EIA Connector
PM-UHF-158	RF Power Meter UHF band 1-5/8" EIA Connector
PM-AM-318	RF Power Meter AM Band 3-1/8" EIA Connector
PM-FM-318	RF Power Meter FM band 3-1/8" EIA Connector
PM-VHFI-318	RF Power Meter VHFI band 3-1/8" EIA Connector
PM-VHFIII-318	RF Power Meter VHFIII band 3-1/8" EIA Connector
PM-UHF-318	RF Power Meter UHF band 3-1/8" EIA Connector
PM-AM-416	RF Power Meter AM Band 4-1/16" EIA Connector
PM-FM-416	RF Power Meter FM band 4-1/16" EIA Connector
PM-VHFI-416	RF Power Meter VHFI band 4-1/16" EIA Connector
PM-VHFIII-416	RF Power Meter VHFIII band 4-1/16" EIA Connector
PM-UHF-416	RF Power Meter UHF band 4-1/16" EIA Connector
PM-AM-618	RF Power Meter AM Band 6-1/8" EIA Connector
PM-FM-618	RF Power Meter FM band 6-1/8" EIA Connector
PM-VHFI-618	RF Power Meter VHFI band 6-1/8" EIA Connector
PM-VHFIII-618	RF Power Meter VHFIII band 6-1/8" EIA Connector
PM-UHF-618	RF Power Meter UHF band 6-1/8" EIA Connector
PM-RD-2U	Rack Mount Display, Added to any Power Meter unit
PM-RD-2UR	Rack Mount Display, Added to any Power Meter, Replaces the line section controller unit.
Note*	AM and FM power meters that are 7/16" DIN or smaller must use a PM-RD-2U unit with external or rack mount directional coupler. Contact the factory to review the order requirements.

Monitor and Control Systems

AAT designs and builds monitor and control systems that interface with many types of equipment applications.

Features:

- Monitoring via HDMI, Ethernet, SNMP, Remote Samples, LCD Display
- Control via Ethernet, SNMP, and DB25
- Easily connect and interface with existing devices

De-Icer Controller Unit



De-icer Controller Unit

- Controls and monitors supply voltages for antenna heating elements.
- Temperature, Humidity, and AC Current monitoring.
- Monitoring via Ethernet Web UI, SNMP, and Remote Samples
- Automatic or Manual control with configurable thresholds.

Specifications:	
Web UI	Dual Temperature, Dual Humidity, and Dual AC Current samples Deicer Status On/Off Automatic Function Enable/Disable Manual Control On/Off
SNMP and Remote Samples	Temp 1, Temp 2, Humidity 1, Humidity 2, AC Current 1, AC Current 2, Deicer Status
Controller Power	120 VAC
Controller Heater Source Voltage	220 VAC, 120 VAC, or Other
Power Consumption	50 Watts
Maximum Heater Source Current	50 Amps
Temperature Range	-10° F to 120° F
Humidity Range	0 – 100 % Relative Humidity

Models:	
Model	
AAT-DE-ICER	

Physical Features:	
Dimensions	14" x 12" x 4.5"
Weight	20 lbs.

Rack Mountable Dehydrator

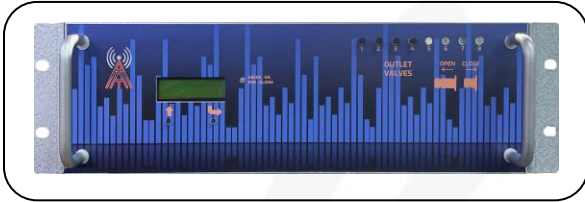

Features:

- Designed for continuous operation and automatic duty
- Continuous tracking of output pressure through the Pulse Width Modulation (PWM) technique.

Specifications:

Model	DM-REH, DM-REH-IP
Output Pressure	Programmable from 1.5– 7 PSI
Max. Flow Rate	254 SCFD (300 l/h)
Output Dew Point	Better than -40 deg F at 68 deg F (20 deg C) ambient temperature and 80% Relative Humidity
Safety Valve	Factory set at 10 PSI +/-15%
Desiccant Regeneration	Automatic by heating
Regeneration Phase Interval	Adaptive according to plant leakages
Local Alarms	Power & system failures; low/high pressure; and high humidity
Remote Alarms	100 – 240 VAC, 50/60 Hz
Power Consumption	≤ 3 W normal operation, < 55 W regeneration phase
Power Supply	100 – 240 VAC, 50/60 Hz
Optional Remote Monitoring Interface	10/100 BaseT ethernet, auto-sensing with the following protocols: HTTP, TCP/IP, SNMP, TFTP, FTP, Telnet, DHCP
Outlets	6 outlets standard
Acoustic Noise	≤ 50 dBA at 3.2 ft (1 m) distance and 5 ft (1.5 m) height
Enclosure Degree of Protection	IP20 according to IEC529
Outlet Fittings	3/8" (9,5 mm) diameter (other fittings on request)
Electrical Connector Type	Dehydrator IEC 320 Type C 14, Controller Micro USB 5 VDC

Physical Features:

Dimensions	5.2" H x 19" W x 9.4" D
Net Weight	14.3 lbs (6.5 kg)

Environmental Specifications:

Operating Temperature	14 – 122°F (-10°C / +50°C)
Storage Temperature	-22 – 140°F (-30°C / +60°C)
High Humidity Alarm	Set at 10% of relative humidity ± 2%

Disclaimer: Specifications are subject to change without notice. Information may be changed or updated without notice. American Amplifier Technologies may also make improvements and/or changes in the products described in this information at any time.

Rack Mountable Dehydrator

MODEL	DESCRIPTION
RM-DEH	Rack Mountable Dehydrator
RM-DEH-IP	Rack Mountable Dehydrator with IP Remote Interface

AC Voltage Surge Protection



Features

- Innovative thermally protected MOV technology
- Quick thermal response self-protected design with internal arc extinguishing
- Optional Monitoring via Ethernet Web UI, SNMP, and Remote Samples.

Specifications:

Standards	UL 1449 4 th Edition, IEC61641-11:2011
Category UL/IEC	Type 1CA for use in Type 1, 2, and 3 Applications/Class C (II)
MCOV (Uc, Vac)	150 VAC, 260 VAC, 280 VAC
Voltage Range	90 – 130 VAC, 190 – 260 VAC, Single or Three Phase, WYE or Delta
SCCR Rating	200 kA
Nominal Discharge Current (8/20) In	20 kA, 50 kA, 100 kA
Max. Discharge Current (8/20) I_{max}	50 kA, 100 kA, 150 kA
Response Time	≤ 25 ns

Models:

AAT-SS-SP -20KA/50KA/100KA
 AAT-SS-WYE3P -50KA/100KA/200KA
 AAT-SS-DEL3P-200KA

Physical Features:

Dimensions	20" x 20" x 6"
Net Weight	45 lbs.

Environmental Specifications:

Operating Temperature Range	-40° C to 80° C
Operating Humidity Range	0 – 90%

AC Voltage Surge Protection

MODEL	DESCRIPTION
AAT-SS-SP-20KA	AC Voltage Surge Protection

EC Series Voltage Monitoring Systems

Features



- Protects equipment from under and over voltage conditions.
- Three Phase or Single Phase Systems.
- Continual real time monitoring.
- Alert/Fault history stored.
- Adjustable voltage monitoring
- User defined start delay, phase error, and voltage thresholds.
- Optional disconnect feature.
- Optional IP interface

The EC series system continually monitors the 50/60 Hz VAC source voltage. When voltage errors occur, the control system prevents unfavorable voltage conditions from being passed to essential equipment. Each system is provided with a prewired and tested enclosure, controller, and contactor.

Specifications:

Models	EC-30 , EC-60 , EC-80 , EC-115 , EC-150 , EC-300, EC-400
Standards	UL Listed
Amperage Rating:	Model Dependent. Model # = Maximum Current Rating. EC-30 = 30 Amp Rating.
Category UL/IEC	Type 1CA for use in Type 1, 2, and 3 Applications/Class C (II)
Voltage Range	190-630 VAC 50/60 Hz Single or Three Phase, WYE or Delta
Response Time	≤ 25 ns

Physical Features:

Dimensions	20" x 20" x 6"
Net Weight	25 lbs.

Environmental Specifications:

Operating Temperature Range	-40° C to 80° C
Operating Humidity Range	0 – 90%

Disclaimer: Specifications are subject to change without notice. Information may be changed or updated without notice. American Amplifier Technologies may also make improvements and/or changes in the products described in this information at any time.

FM Antenna Systems

AAT manufactures quality FM antenna systems, providing broadcasters with a reliable product using high quality stainless steel, brass, and copper materials.

- Multiple Polarization Options
- Multi-Bay Systems Available
- Low, Medium, and High Power Systems
- Multi-Channel Systems
- Omni Directional Systems
- Custom Directional Patterns Available

SF-M FM Antenna Systems



Features:

- Circular Polarization
- Multi-Channel Systems
- Directional Systems
- Low, Medium, and High Power Ratings
- Broadband Systems



Specifications:

Frequency	87 – 108 MHz
Input Power Rating	10 kW – 210 kW
Polarization	Circular
Azimuth	±2 dB free space
VSWR	1.5 : 1 or better
Connections Available:	EIA: 1-5/8", 3-1/8" EIA, 4-1/16", 6-1/8"

Standard Models:

Model	Power Rating	Power Gain		dB Gain	
		Full Wave	Half Wave	Full Wave	Half Wave
SF-M-1	10-40 kW	0.46	NA	-3.37	NA
SF-M-2	10-40 kW	0.95	0.73	-0.22	-1.36
SF-M-3	10-40 kW	1.55	1.02	1.90	0.08
SF-M-4	10-40 kW	2.13	1.35	3.28	1.30
SF-M-5	40 kW	2.72	1.63	4.35	2.12
SF-M-6	40 kW	3.25	1.89	5.12	2.76
SF-M-7	40 kW	3.90	2.19	5.91	3.40
SF-M-8	40 kW	4.28	2.61	6.31	4.17
SF-M-9	40 kW	5.05	2.79	7.03	4.46
SF-M-10	40 kW	5.54	3.14	7.44	4.97
SF-M-11	40 kW	6.25	3.39	7.96	5.30
SF-M-12	40 kW	6.25	3.39	7.96	5.30

Notes:

- > 40 kW ratings available upon engineering review.
- Includes standard mounting brackets and attachment hardware.
- Antenna weight and wind load are approximate values for a typical structure. Final design loads may vary for the specific application.

Disclaimer: Specifications are subject to change without notice. Information may be changed or updated without notice. American Amplifier Technologies™ may also make improvements and/or changes in the products and/or pricing described at any time without notice

SF-M FM Antenna Systems

MODEL	DESCRIPTION
SF-M-1E	1 bay End Fed SF FM Antenna System
SF-M-2E	2 bay End Fed SF FM Antenna System
SF-M-2C	2 bay Center Fed SF FM Antenna System
SF-M-2E-HW	2 bay Half Wave End Fed SF FM Antenna System
SF-M-2C-HW	2 bay Half Wave Center Fed SF FM Antenna System
SF-M-3E	3 bay End Fed SF FM Antenna System
SF-M-3C	3 bay Center Fed SF FM Antenna System
SF-M-3E-HW	3 bay Half Wave End Fed SF FM Antenna System
SF-M-3C-HW	3 bay Half Wave Center Fed SF FM Antenna System
SF-M-4E	4 bay End Fed SF FM Antenna System
SF-M-4C	4 bay Center Fed SF FM Antenna System
SF-M-4E-HW	4 bay Half Wave End Fed SF FM Antenna System
SF-M-4C-HW	4 bay Half Wave Center Fed SF FM Antenna System
SF-M-5E	5 Bay End Fed SF FM Antenna System
SF-M-5C	5 Bay Center Fed SF FM Antenna System
SF-M-5E-HW	5 Bay Half Wave End Fed SF FM Antenna System
SF-M-5C-HW	5 Bay Half Wave Center Fed SF FM Antenna System
SF-M-6C	6 Bay Center Fed SF FM Antenna System
SF-M-6C-HW	6 Bay Half Wave Center Fed SF FM Antenna System
SF-M-7C	7 Bay Center Fed SF FM Antenna System
SF-M-7C-HW	7 Bay Half Wave Center Fed SF FM Antenna System
SF-M-8C	8 Bay Center Fed SF FM Antenna System
SF-M-8C-HW	8 Bay Half Wave Center Fed SF FM Antenna System
SF-M-9C	9 Bay Center Fed SF FM Antenna System
SF-M-9C-HW	9 Bay Half Wave Center Fed SF FM Antenna System
SF-M-10C	10 Bay Center Fed SF FM Antenna System
SF-M-10C-HW	10 Bay Half Wave Center Fed SF FM Antenna System
SF-M-11C	11 Bay Center Fed SF FM Antenna System
SF-M-11C-HW	11 Bay Half Wave Center Fed SF FM Antenna System
SF-M-12C	12 Bay Center Fed SF FM Antenna System
SF-M-12C-HW	12 Bay Half Wave Center Fed SF FM Antenna System

SF-HP FM Antennas

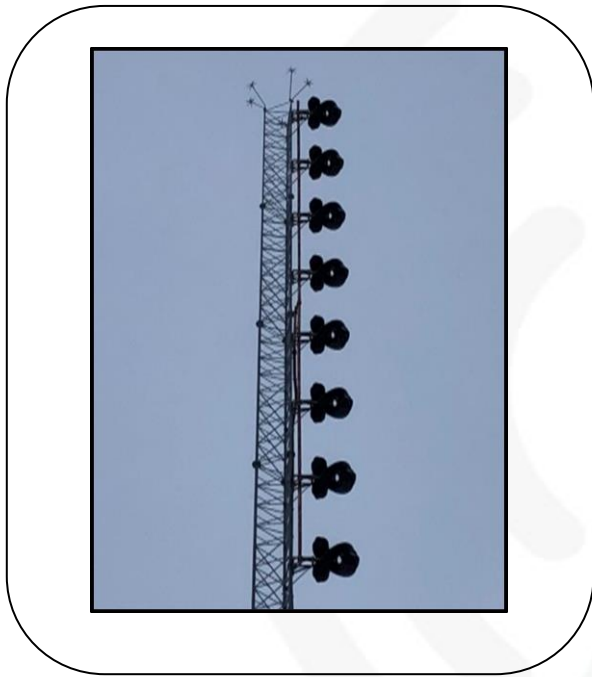

SF-HP Series

- Circular Polarization
- Multi-Channel Systems
- Directional Systems
- High Power Input Ratings
- Broadband Systems

Specifications:

Frequency	87– 108 MHz	Connections Available: EIA: 3-1/8" EIA, 4-1/16", 6-1/8"
Input Power Rating	40 kW - 210 kW	
Polarization	Circular	
Azimuth	±2dB free space	
VSWR	1.3:1 or better	

Models:

Model	Power Rating	Power Gain	
		Full Wave	dB gain Half Wave
SF-HP-1	40 kW	0.46	NA
SF-HP-2	40 kW	0.95	0.73
SF-HP-3	40 kW	1.55	1.02
SF-HP-4	40 kW	2.13	1.35
SF-HP-5	40 kW	2.72	1.63
SF-HP-6	40 kW	3.25	1.89
SF-HP-7	40 kW	3.90	2.19
SF-HP-8	40 kW	4.28	2.61
SF-HP-9	40 kW	5.05	2.79
SF-HP-10	40 kW	5.54	3.14
SF-HP-11	40 kW	6.25	3.39
SF-HP-12	40 kW	6.57	3.70

- > 40 KW ratings available upon engineering review.
- Includes standard mounting brackets and attachment hardware.
- Antenna weight and wind load are approximate values for a typical structure. Final design loads may vary for the specific application.

SF-HP FM Antenna Systems

MODEL	DESCRIPTION
SF-HP-1E	1 bay End Fed SF FM Antenna System
SF-HP-2E	2 bay End Fed SF FM Antenna System
SF-HP-2C	2 bay Center Fed SF FM Antenna System
SF-HP-2E-HW	2 bay Half Wave End Fed SF FM Antenna System
SF-HP-2C-HW	2 bay Half Wave Center Fed SF FM Antenna System
SF-HP-3E	3 bay End Fed SF FM Antenna System
SF-HP-3C	3 bay Center Fed SF FM Antenna System
SF-HP-3E-HW	3 bay Half Wave End Fed SF FM Antenna System
SF-HP-3C-HW	3 bay Half Wave Center Fed SF FM Antenna System
SF-HP-4E	4 bay End Fed SF FM Antenna System
SF-HP-4C	4 bay Center Fed SF FM Antenna System
SF-HP-4E-HW	4 bay Half Wave End Fed SF FM Antenna System
SF-HP-4C-HW	4 bay Half Wave Center Fed SF FM Antenna System
SF-HP-5E	5 Bay End Fed SF FM Antenna System
SF-HP-5C	5 Bay Center Fed SF FM Antenna System
SF-HP-5E-HW	5 Bay Half Wave End Fed SF FM Antenna System
SF-HP-5C-HW	5 Bay Half Wave Center Fed SF FM Antenna System
SF-HP-6C	6 Bay Center Fed SF FM Antenna System
SF-HP-6C-HW	6 Bay Half Wave Center Fed SF FM Antenna System
SF-HP-7C	7 Bay Center Fed SF FM Antenna System
SF-HP-7C-HW	7 Bay Half Wave Center Fed SF FM Antenna System
SF-HP-8C	8 Bay Center Fed SF FM Antenna System
SF-HP-8C-HW	8 Bay Half Wave Center Fed SF FM Antenna System
SF-HP-9C	9 Bay Center Fed SF FM Antenna System
SF-HP-9C-HW	9 Bay Half Wave Center Fed SF FM Antenna System
SF-HP-10C	10 Bay Center Fed SF FM Antenna System
SF-HP-10C-HW	10 Bay Half Wave Center Fed SF FM Antenna System
SF-HP-11C	11 Bay Center Fed SF FM Antenna System
SF-HP-11C-HW	11 Bay Half Wave Center Fed SF FM Antenna System
SF-HP-12C	12 Bay Center Fed SF FM Antenna System
SF-HP-12C-HW	12 Bay Half Wave Center Fed SF FM Antenna System

FM IV-CP Antenna Systems

Features



- FM Band 88-108 MHz
- Broadband System
- Non Pressurized
- Multiple Bay Systems Available
- Omni-Directional Azimuth Pattern
- Directional Patterns Available
- High-Quality Stainless Steel, Brass, and Copper Materials

Specifications:

Frequency Range	FM Band 88-108 MHz
Input Power Rating	2 kW – 8 kW
Polarization	Circular
Azimuth	±2 dB free space
VSWR	1.30 : 1 (or better)
Connections Available	Type N, 7/16 DIN, EIA Flange

Standard Models:

Model	Power Rating	Power Gain		dB gain		Weight	Wind Area (CaAa) ft ²
		Full Wave	Half Wave	Full Wave	Half Wave		
IV-CP-1	2 kW	0.46	NA	-3.37	NA	24 lbs	1.2
IV-CP-2	4 kW	0.95	0.73	-0.22	-1.36	55 lbs	3.7
IV-CP-3	6 kW	1.55	1.02	1.90	0.08	77 lbs	5.2
IV-CP-4	8 kW	2.13	1.35	3.28	1.30	110 lbs	7.8
IV-CP-5	8 kW	2.72	1.63	4.35	2.12	134 lbs	8.8
IV-CP-6	8 kW	3.25	1.89	5.12	2.76	158 lbs	10.8

Notes:

- Includes standard mounting brackets and attachment hardware.
- > 4-bay systems available after engineering review
- Antenna weight and wind load calculations are approximate values for a typical structure. Final design loads may vary for the specific application.

Disclaimer: Specifications are subject to change without notice. Information may be changed or updated without notice. American Amplifier Technologies™ may also make improvements and/or changes in the products and/or pricing described at any time without notice.

FM IV-CP Antenna Systems

MODEL	DESCRIPTION
FM-IV-CP-1	1 bay IV-CP Antenna System
FM-IV-C -2	2 bay IV-CP Antenna System
FM-IV-CP-3	3 bay IV-CP Antenna System
FM-IV-CP-4	4 bay IV-CP Antenna System
FM-IV-CP-5	5 bay IV-CP Antenna System
FM-IV-CP-6	6 bay IV-CP Antenna System

Mounting member sizes: 1.5" – 3.5", other sizes available upon request

FM IV-CP-M Antenna System

Features:



- 87 - 108 MHz
- Pressurized
- Multi-Channel Systems
- Multiple Bay Systems Available
- High-Quality Stainless Steel, Brass, and Copper Materials



Specifications:

Frequency	87– 108 MHz
Input Power Rating	10 kW – 100 kW
Polarization	Circular
Azimuth	±2dB free space
Connections Available:	EIA: 1-5/8", 3-1/8" EIA, 4-1/16", 6-1/8"

Standard Models:

Model	Power Rating	Power Gain		dB gain		Weight lbs	Wind Load lbs
		Full Wave	Half Wave	Full Wave	Half Wave		
IV-CP-M1	10 kW	0.46	NA	-3.37	NA	55	59
IV-CP-M2E	20 kW	0.95	0.73	-0.22	-1.36	125	181
IV-CP-M2C	20 kW	0.95	0.73	-0.22	-1.36	125	181
IV-CP-M3E	20 kW	1.55	1.02	1.90	0.08	182	271
IV-CP-M3C	20 kW	1.55	1.02	1.90	0.08	182	271
IV-CP-M4E	20 kW	2.13	1.35	3.28	1.30	220	318
IV-CP-M4C	30 kW	2.13	1.35	3.28	1.30	220	318
IV-CP-M5E	20 kW	2.72	1.63	4.35	2.12	315	508
IV-CP-M5C	40 kW	2.72	1.63	4.35	2.12	315	508
IV-CP-M6C	40 kW	3.25	1.89	5.12	2.76	375	614
IV-CP-M7C	40 kW	3.90	2.19	5.91	3.40	457	756
IV-CP-M8C	40 kW	4.28	2.61	6.31	4.17	510	836
IV-CP-M9C	40 kW	5.05	2.79	7.03	4.46	573	955
IV-CP-M10C	40 kW	5.54	3.14	7.44	4.97	635	1010
IV-CP-M11C	40 kW	6.25	3.39	7.96	5.30	713	1188
IV-CP-M12C	40 kW	6.57	3.70	8.18	5.68	768	1219

Notes: E = End, C = Center

- > 40 kW ratings available upon engineering review.
- Includes standard mounting brackets and attachment hardware.
- Antenna weight and wind load are approximate values for a typical structure. Final design loads may vary for the specific application.

Disclaimer: Specifications are subject to change without notice. Information may be changed or updated without notice. American Amplifier Technologies™ may also make improvements and/or changes in the products and/or pricing described at any time without notice.

FM IV-CP-M Antenna Systems

MODEL	DESCRIPTION
IV-CP-M-1	1 bay side mount antenna system
IV-CP-M-2	2 bay side mount antenna system
IV-CP-M-2-HW	2 bay half wave side mount antenna system
IV-CP-M-3	3 bay side mount antenna system
IV-CP-M-3-HW	3 bay half wave side mount antenna system
IV-CP-M-4	4 bay side mount antenna system
IV-CP-M-4-HW	4 bay half wave side mount antenna system
IV-CP-M-5	5 bay side mount antenna system
IV-CP-M-5-HW	5 bay half wave side mount antenna system
IV-CP-M-6	6 bay side mount antenna system
IV-CP-M-6-HW	6 bay half wave side mount antenna system
IV-CP-M-7	7 bay side mount antenna system
IV-CP-M-7-HW	7 bay half wave side mount antenna system
IV-CP-M-8	8 bay side mount antenna system
IV-CP-M-8-HW	8 bay half wave side mount antenna system
IV-CP-M-9	9 bay side mount antenna system
IV-CP-M-9-HW	9 bay half wave side mount antenna system
IV-CP-M-10	10 bay side mount antenna system
IV-CP-M-10-HW	10 bay half wave side mount antenna system
IV-CP-M-11	11 bay side mount antenna system
IV-CP-M-11-HW	11 bay half wave side mount antenna system
IV-CP-M-12	12 bay side mount antenna system
IV-CP-M-12-HW	12 bay half wave side mount antenna system

FM V-DP



Features:

- Light Weight Antenna System
- Multi-Bay Systems Available
- Low, Medium, and High Power Systems
- Multi-Channel Systems
- Broadband Antenna



Specifications:

Model	V-DP
Frequency	85-108 MHz
VSWR	1.5 : 1 or better
Power Gain	1.0 single bay
Polarization	Vertical, Horizontal, Slant(H&V)
Input Power Rating	5000 watts, Single Bay, Higher Power Ratings Available
Connector	7/8" EIA or 7/16" DIN
Material	Stainless Steel
Mounting Member	2" thru 4.5" OD, Smaller and Larger Mounting Configurations Available
Dimensions	2" X 37" X 55"
Net Weight	20 lbs.

Disclaimer: Specifications are subject to change without notice. Information may be changed or updated without notice. American Amplifier Technologies™ may also make improvements and/or changes in the products described in this information at any time.

FM V-DP

MODEL	DESCRIPTION
V-DP-1	1 Bay V-DP FM Antenna
V-DP-2	2 Bay V-DP FM Antenna
V-DP-3	3 Bay V-DP FM Antenna
V-DP-4	4 Bay V-DP FM Antenna
V-DP-5	5 Bay V-DP FM Antenna
V-DP-6	6 Bay V-DP FM Antenna

FM V-DP-M Antenna System

Features



- Frequency: 87 - 108MHz
- Multiple Bay Systems Available
- High quality stainless steel, brass, and copper materials.
- Multi-Channel Systems
- Pressurized

The V-DP-M series product is a high power FM side mount antenna system. The V-DP-M systems provide excellent solutions for vertical only polarized FM station applications. Systems are available in half wave and full wave configurations. Special spacing configurations are available upon request.

Specifications:

Frequency	87– 108 MHz
Input Power Rating	10 kW – 60 kW
Polarization	Vertical
Azimuth	±2dB free space
Connections Available:	EIA: 1-5/8", 3-1/8" EIA, 4-1/16", 6-1/8"

Standard Models:

Model	Power Rating	Power Gain		dB gain		Weight	Wind Load
		Full Wave	Half Wave	Full Wave	Half Wave	lbs	lbs
V-DP-M1	10 kW	0.97	NA	-0.132	NA	22	52
V-DP-M2	10 kW	1.99	1.00	2.99	0.00	52	119
V-DP-M3	10 kW	3.20	1.60	5.05	2.04	76	178
V-DP-M4	10 kW	4.40	2.20	6.43	3.42	111	251
V-DP-M5	10 kW	5.45	2.73	7.36	4.36	154	353
V-DP-M6	10 kW	6.55	3.28	8.16	5.16	174	775
V-DP-M7	10 kW	7.70	3.85	8.86	5.85	220	387
V-DP-M8	10 kW	8.75	4.38	9.42	6.41	251	575
V-DP-M9	10 kW	9.89	4.95	9.95	6.95	272	603
V-DP-M10	10 kW	10.89	5.45	10.40	7.36	311	712
V-DP-M11	10 kW	11.90	5.95	10.80	7.75	342	776
V-DP-M12	10 kW	13.35	6.68	11.30	8.25	370	841
V-DP-M13	10 kW	14.15	7.08	11.50	8.50	401	917
V-DP-M14	10 kW	15.60	7.80	11.90	8.92	432	984

- > 10 kW ratings available upon engineering review.
- Includes standard mounting brackets and attachment hardware.

Disclaimer: Specifications are subject to change without notice. Information may be changed or updated without notice. American Amplifier Technologies™ may also make improvements and/or changes in the products described in this information at any time.

FM V-DP-M

MODEL	DESCRIPTION
V-DP-M1	1 Bay Vertical Dipole Medium Power Antenna System
V-DP-M1-HW	1 Bay Half Wave Vertical Dipole Medium Power Antenna System
V-DP-M2	2 Bay Vertical Dipole Medium Power Antenna System
V-DP-M2-HW	2 Bay Half Wave Vertical Dipole Medium Power Antenna System
V-DP-M3	3 Bay Vertical Dipole Medium Power Antenna System
V-DP-M3-HW	3 Bay Half Wave Vertical Dipole Medium Power Antenna System
V-DP-M4	4 Bay Vertical Dipole Medium Power Antenna System
V-DP-M4-HW	4 Bay Half Wave Vertical Dipole Medium Power Antenna System
V-DP-M5	5 Bay Vertical Dipole Medium Power Antenna System
V-DP-M5-HW	5 Bay Half Wave Vertical Dipole Medium Power Antenna System
V-DP-M6	6 Bay Vertical Dipole Medium Power Antenna System
V-DP-M6-HW	6 Bay Half Wave Vertical Dipole Medium Power Antenna System
V-DP-M7	7 Bay Vertical Dipole Medium Power Antenna System
V-DP-M7-HW	7 Bay Half Wave Vertical Dipole Medium Power Antenna System
V-DP-M8	8 Bay Vertical Dipole Medium Power Antenna System
V-DP-M8-HW	8 Bay Half Wave Vertical Dipole Medium Power Antenna System
V-DP-M9	9 Bay Vertical Dipole Medium Power Antenna System
V-DP-M9-HW	9 Bay Half Wave Vertical Dipole Medium Power Antenna System
V-DP-M10	10 Bay Vertical Dipole Medium Power Antenna System
V-DP-M10-HW	10 Bay Half Wave Vertical Dipole Medium Power Antenna System
V-DP-M11	11 Bay Vertical Dipole Medium Power Antenna System
V-DP-M11-HW	11 Bay Half Wave Vertical Dipole Medium Power Antenna System
V-DP-M12	12 Bay Vertical Dipole Medium Power Antenna System
V-DP-M12-HW	12 Bay Half Wave Vertical Dipole Medium Power Antenna System
V-DP-M13	13 Bay Vertical Dipole Medium Power Antenna System
V-DP-M13-HW	13 Bay Half Wave Vertical Dipole Medium Power Antenna System
V-DP-M14	14 Bay Vertical Dipole Medium Power Antenna System
V-DP-M14-HW	14 Bay Half Wave Vertical Dipole Medium Power Antenna System

FM V-DP-H Antenna Systems

Features



- Frequency: 87 - 108MHz
- Multiple Bay Systems Available
- High quality stainless steel, brass, and copper materials.
- Multi-Channel Systems

Specifications:

Frequency	87– 108 MHz
Input Power Rating	10 kW – 60 kW
Polarization	Vertical
Azimuth	±2dB free space
Connections	EIA: 1-5/8", 3-1/8" EIA, 4-1/16", 6-1/8"
Available:	

Standard Models:

Model	Power Rating	Power Gain		dB gain		Weight <i>lbs</i>	Wind Load <i>lbs</i>
		Full Wave	Half Wave	Full Wave	Half Wave		
V-DP-H1	20 kW	0.97	NA	-0.132	NA	45	103
V-DP-H2	30 kW	1.99	1.00	2.99	0.00	105	239
V-DP-H3	30 kW	3.20	1.60	5.05	2.04	156	356
V-DP-H4	30 kW	4.40	2.20	6.43	3.42	220	502
V-DP-H5	30 kW	5.45	2.73	7.36	4.36	310	707
V-DP-H6	30 kW	6.55	3.28	8.16	5.16	340	775
V-DP-H7	30 kW	7.70	3.85	8.86	5.85	435	992
V-DP-H8	30 kW	8.75	4.38	9.42	6.41	505	1151
V-DP-H9	30 kW	9.89	4.95	9.95	6.95	553	1261
V-DP-H10	30 kW	10.89	5.45	10.40	7.36	625	1425
V-DP-H11	30 kW	11.90	5.95	10.80	7.75	682	1555
V-DP-H12	30 kW	13.35	6.68	11.30	8.25	740	1687
V-DP-H13	30 kW	14.15	7.08	11.50	8.50	805	1835
V-DP-H14	30 kW	15.60	7.80	11.90	8.92	863	1968

Notes: E = End, C = Center

- > 30 kW ratings available upon engineering review.
- Includes standard mounting brackets and attachment hardware.

FM V-DP-H Antenna Systems

MODEL	DESCRIPTION
V-DP-H1	1 Bay Vertical Dipole High Power Antenna System
V-DP-H1-HW	1 Bay Half Wave Vertical Dipole High Power Antenna System
V-DP-H2	2 Bay Vertical Dipole High Power Antenna System
V-DP-H2-HW	2 Bay Half Wave Vertical Dipole High Power Antenna System
V-DP-H3	3 Bay Vertical Dipole High Power Antenna System
V-DP-H3-HW	3 Bay Half Wave Vertical Dipole High Power Antenna System
V-DP-H4	4 Bay Vertical Dipole High Power Antenna System
V-DP-H4-HW	4 Bay Half Wave Vertical Dipole High Power Antenna System
V-DP-H5	5 Bay Vertical Dipole High Power Antenna System
V-DP-H5-HW	5 Bay Half Wave Vertical Dipole High Power Antenna System
V-DP-H6	6 Bay Vertical Dipole High Power Antenna System
V-DP-H6-HW	6 Bay Half Wave Vertical Dipole High Power Antenna System
V-DP-H7	7 Bay Vertical Dipole High Power Antenna System
V-DP-H7-HW	7 Bay Half Wave Vertical Dipole High Power Antenna System
V-DP-H8	8 Bay Vertical Dipole High Power Antenna System
V-DP-H8-HW	8 Bay Half Wave Vertical Dipole High Power Antenna System
V-DP-H9	9 Bay Vertical Dipole High Power Antenna System
V-DP-H9-HW	9 Bay Half Wave Vertical Dipole High Power Antenna System
V-DP-H10	10 Bay Vertical Dipole High Power Antenna System
V-DP-H10-HW	10 Bay Half Wave Vertical Dipole High Power Antenna System
V-DP-H11	11 Bay Vertical Dipole High Power Antenna System
V-DP-H11-HW	11 Bay Half Wave Vertical Dipole High Power Antenna System
V-DP-H12	12 Bay Vertical Dipole High Power Antenna System
V-DP-H12-HW	12 Bay Half Wave Vertical Dipole High Power Antenna System
V-DP-H13	13 Bay Vertical Dipole High Power Antenna System
V-DP-H13-HW	13 Bay Half Wave Vertical Dipole High Power Antenna System
V-DP-H14	14 Bay Vertical Dipole High Power Antenna System
V-DP-H14-HW	14 Bay Half Wave Vertical Dipole High Power Antenna System

H Series FM Antenna Systems



Features:

- Horizontal Polarization
- Multi-Bay Systems Available
- Low, Medium, and High Power Systems
- Multi-Channel Systems
- Omni Directional Systems
- Custom Directional Patterns Available

Specifications:

Model	FM-H
Frequency	88 – 108 MHz
Input Power Rating	10 kW – 60 kW
Polarization	Horizontal
Azimuth	±2dB free space
VSWR	1.5 : 1 or better
Connections Available	EIA: 1-5/8", 3-1/8", 4-1/16", 6-1/8"

Standard Models:

Model	Power Rating	Power Gain		dB gain	
		Full Wave	Half Wave	Full Wave	Half Wave
H-1	10-60 kW	0.905	NA	-0.433	NA
H-2	10-60 kW	1.951	1.413	2.902	1.501
H-3	10-60 kW	2.998	2.029	4.768	3.072
H-4	10-60 kW	4.165	2.676	6.196	4.274
H-5	10-60 kW	5.231	3.270	7.185	5.145
H-6	10-60 kW	6.526	3.971	8.146	5.988
H-7	10-60 kW	7.685	4.677	8.856	6.699
H-8	10-60 kW	8.865	5.199	9.476	7.159
H-9	10-60 kW	10.055	5.896	10.023	7.705
H-10	10-60 kW	11.122	6.377	10.461	8.046
H-11	10-60 kW	12.564	7.203	10.991	8.575
H-12	10-60 kW	13.533	7.758	11.313	8.897

Notes:

- > 40 kW ratings available upon engineering review.
- Includes standard mounting brackets and attachment hardware.
- Antenna weight and wind load are approximate values for a typical structure. Final design loads may vary for the specific application.

Disclaimer: Specifications are subject to change without notice. Information may be changed or updated without notice. American Amplifier Technologies™ may also make improvements and/or changes in the products and/or pricing described at any time without notice.

H Series FM Antenna System

MODEL	DESCRIPTION
H-1	1 Bay H Series FM Antenna System
H-1-HW	1 Bay Half Wave H Series FM Antenna System
H-2	2 Bay H Series FM Antenna System
H-2-HW	2 Bay Half Wave H Series FM Antenna System
H-3	3 Bay H Series FM Antenna System
H-3-HW	3 Bay Half Wave H Series FM Antenna System
H-4	4 Bay H Series FM Antenna System
H-4-HW	4 Bay Half Wave H Series FM Antenna System
H-5	5 Bay H Series FM Antenna System
H-5-HW	5 Bay Half Wave H Series FM Antenna System
H-6	6 Bay H Series FM Antenna System
H-6-HW	6 Bay Half Wave H Series FM Antenna System
H-7	7 Bay H Series FM Antenna System
H-7-HW	7 Bay Half Wave H Series FM Antenna System
H-8	8 Bay H Series FM Antenna System
H-8-HW	8 Bay Half Wave H Series FM Antenna System
H-9	9 Bay H Series FM Antenna System
H-9-HW	9 Bay Half Wave H Series FM Antenna System
H-10	10 Bay H Series FM Antenna System
H-10-HW	10 Bay Half Wave H Series FM Antenna System
H-11	11 Bay H Series FM Antenna System
H-11-HW	11 Bay Half Wave H Series FM Antenna System
H-12	12 Bay H Series FM Antenna System
H-12-HW	12 Bay Half Wave H Series FM Antenna System

FM Panel Antenna Systems



Features:

- Circular, Horizontal, & Elliptical Polarizations
- Multi-Bay Systems Available
- Low, Medium, and High Power Systems
- Multi-Channel Systems
- Omni Directional Systems
- Custom Directional Patterns Available

Specifications:

Model	FM-P-CP-1
Frequency	87 – 108 MHz
Input Power Rating	5 kW – 60 kW
Polarization	Circular, Elliptical, & Horizontal Polarizations available
Azimuth	±2dB free space
VSWR	1.3 : 1 or better
Connections Available	EIA: 1-5/8", 3-1/8", 4-1/16", 6-1/8"

Standard Models:

Model	Power Rating	Power Gain	dB gain
FM-P-CP-1	10-30 kW	1.82	2.60

Notes:

- > 10 kW ratings available upon engineering review.
- Includes standard mounting brackets and attachment hardware.
- Antenna weight and wind load are approximate values for a typical structure. Final design loads may vary for the specific application.

Disclaimer: Specifications are subject to change without notice. Information may be changed or updated without notice. American Amplifier Technologies™ may also make improvements and/or changes in the products and/or pricing described at any time without notice.

FM Panel Antenna Systems

MODEL	DESCRIPTION
P-CP-1	1 Panel FM Antenna System

Contact the factory for a specified quote

Email: sales@americanamptech.com

Phone: 916-978-1899

FDP-1 FM Antenna



Features

- Light Weight Directional Systems
- Multi-Bay Systems Available
- Low, Medium, and High Power Systems
- Multi-Channel Systems
- Custom Directional Patterns

Specifications:

Model	FDP-1
Frequency	85 – 108 MHz
VSWR	1.5 : 1 or better
Power Gain	1.20 Typical
Polarization	Circular
Input Power Rating	2500 watts, Single Bay, Higher Power Ratings Available
Connector	7/8" EIA, 1-5/8" EIA
Material	Aluminum, Optional Stainless Steel
Mounting Member	2" thru 4.5" OD, Smaller and Larger Mounting Configurations Available
Dimensions	53" W X 45" L X 53" H
Net Weight	35 lbs.

Disclaimer: Specifications are subject to change without notice. Information may be changed or updated without notice. American Amplifier Technologies may also make improvements and/or changes in the products described in this information at any time.

FDP-1 FM Antenna System

MODEL	DESCRIPTION
FDP-1	FDP-1 FM Antenna System

Contact the factory for a specified quote

Email: sales@americanamptech.com

Phone: 916-978-1899

FDP-1-SP FM Antenna Systems

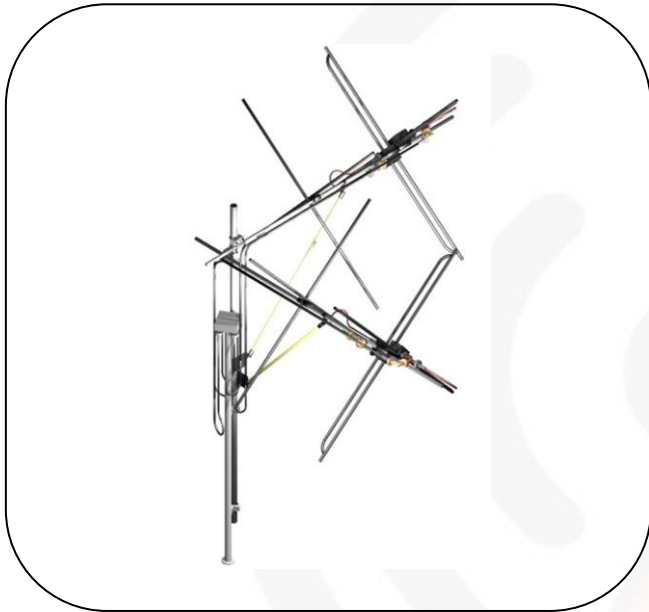

Features:

- Light Weight Directional Systems
- Multi-Bay Systems Available
- Low, Medium, and High Power Systems
- Multi-Channel Systems
- Custom Directional Patterns



Specifications:

Model	FDP-1-SP
Frequency	85 – 108 MHz
VSWR	1.5 : 1 or better
Power Gain	0.91 Typical
Polarization	Circular
Input Power Rating	5000 watts, Single Bay, Higher Power Ratings Available
Connector	7/8" EIA, 1-5/8" EIA
Material	Aluminum, Optional Stainless Steel
Mounting Member	2" thru 4.5" OD, Smaller and Larger Mounting Configurations Available
Dimensions	104.5" W X 104.5" L X 53" H
Net Weight	80 lbs.

Disclaimer: Specifications are subject to change without notice. Information may be changed or updated without notice. American Amplifier Technologies™ may also make improvements and/or changes in the products described at any time.

FDP-1-SP FM Antenna System

MODEL	DESCRIPTION
FDP-1-SP	FDP-1-SP FM Antenna System

Contact the factory for a specified quote

Email: sales@americanamptech.com

Phone: 916-978-1899

FM 3-Element Yagi Antenna System

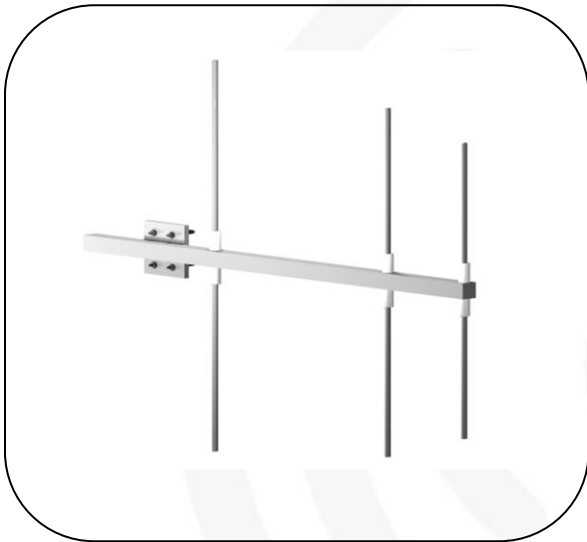

Features:

- Light Weight Directional System
- Multi-Bay Systems Available
- Low, Medium, and High Power Systems
- Multi-Channel Systems



Specifications:

Model	FMY-3
Frequency	85 - 108 MHz
VSWR	1.5 : 1 or better
Power Gain	3.5 Single Bay
Polarization	Vertical, Horizontal, Slant(H&V)
Input Power Rating	5000 Watts, Single Bay, Higher Power Ratings Available
Connector	7/8" EIA
Material	Aluminum, Optional Stainless Steel
Mounting Member	2" thru 4.5" OD, Smaller and Larger Mounting Configurations Available.
Dimensions	2" X 37" X 55"
Net Weight	30 lbs.

Disclaimer: Specifications are subject to change without notice. Information may be changed or updated without notice. American Amplifier Technologies™ may also make improvements and/or changes to the products described at any time.

FM 3-Element Yagi Antenna System

MODEL	DESCRIPTION
FMY-3	1 Bay 3-Element Yagi Antenna System

Contact the factory for a specified quote

Email: sales@americanamptech.com

Phone: 916-978-1899

FM Log-Periodic Antenna System



Features:

- Light Weight Directional System
- Multi-Bay Systems Available
- Low, Medium, and High Power Systems
- Broadband 87 - 108 MHz

Specifications:

Model	FM-LOG
Frequency	87 - 108 MHz
VSWR	1.4 : 1 or better
Power Gain	5.12 (vertical or horizontal) 2.56 (slant)
Polarization	Vertical, Horizontal, Slant(H&V)
Input Power Rating	6000 Watt, Single Bay, Higher Power Ratings Available
Connector	7/8" EIA, 1-5/8" EIA, 3-1/8" EIA
Material	Aluminum, Copper, and Brass
Mounting Member	2" thru 4.5" OD, Other Mounting Member Sizes Available.
Dimensions	104" X 67"
Net Weight	56 lbs.

Disclaimer: Specifications are subject to change without notice. Information may be changed or updated without notice. American Amplifier Technologies™ may also make improvements and/or changes to the products described at any time.

FM Log-Periodic Antenna System

MODEL	DESCRIPTION
FM-LOG	Log Periodic FM antenna system

Contact the factory for a specified quote

Email: sales@americanamptech.com

Phone: 916-978-1899

TV Antenna Systems

AAT manufactures quality TV antenna systems using high quality stainless steel, brass, and copper materials.

- Multiple Polarization Options
- Multi-Bay Systems Available
- Low, Medium, and High Power Systems
- Multi-Channel Systems
- Broadband Systems
- Custom Directional Patterns Available

UHF Slot TV Antenna Systems



Features:

- Directional Systems
- Broadband Systems
- Horizontal Polarization
- Elliptical Polarization
- Multi-Channel Systems
- Low, Medium, and High Power Ratings



Specifications:

Model	SL-UHF
Frequency	UHF IV, V
Input Power Rating	1 kW – 40 kW
Polarization	Horizontal, Elliptical
VSWR	1.17 : 1 or better
Connections Available:	EIA: 7/8", 1-5/8", 3-1/8", 4-1/16", 6-1/8"

Notes:

- > 5 KW ratings available upon engineering review.
- Includes standard mounting brackets and attachment hardware.
- Antenna weight and wind load are approximate values for a typical structure. Final design loads may vary for the specific application.

Disclaimer: Specifications are subject to change without notice. Information may be changed or updated without notice. American Amplifier Technologies™ may also make improvements and/or changes in the products and/or pricing described at any time without notice.

UHF Slot TV Antenna System

MODEL	DESCRIPTION
SL-UHF-4E	4 Bay UHF TV Slot Antenna
SL-UHF-6E	6 Bay UHF TV Slot Antenna
SL-UHF-8E	8 Bay UHF TV Slot Antenna
SL-UHF-12E	12 Bay UHF TV Slot Antenna
SL-UHF-16E	16 Bay UHF TV Slot Antenna

UHF Panel TV Antenna Systems

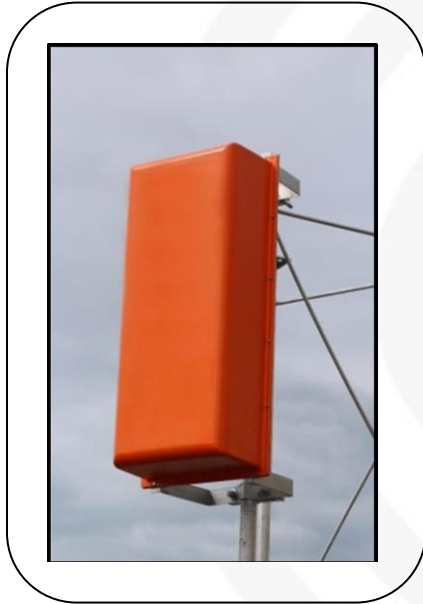

Features:

- Directional Systems
- Broadband Systems
- Circular Polarization
- Vertical Polarization
- Horizontal Polarization
- Elliptical Polarization
- Multi-Channel Systems
- Low, Medium, and High Power Ratings



Specifications:

Model	PA-UHF
Frequency	UHF IV, V
Input Power Rating	1 kW – 40 kW
Polarization	Circular, Horizontal, Vertical, Elliptical
VSWR	1.17 : 1 or better
Connections Available:	EIA: 7/8", 1-5/8", 3-1/8" EIA, 4-1/16", 6-1/8"

Notes:

- > 5 kW ratings available upon engineering review.
- Includes standard mounting brackets and attachment hardware.
- Antenna weight and wind load are approximate values for a typical structure. Final design loads may vary for the specific application.

Disclaimer: Specifications are subject to change without notice. Information may be changed or updated without notice. American Amplifier Technologies may also make improvements and/or changes in the products and/or pricing described at any time without notice.

VHF Band I & III Panel Antennas

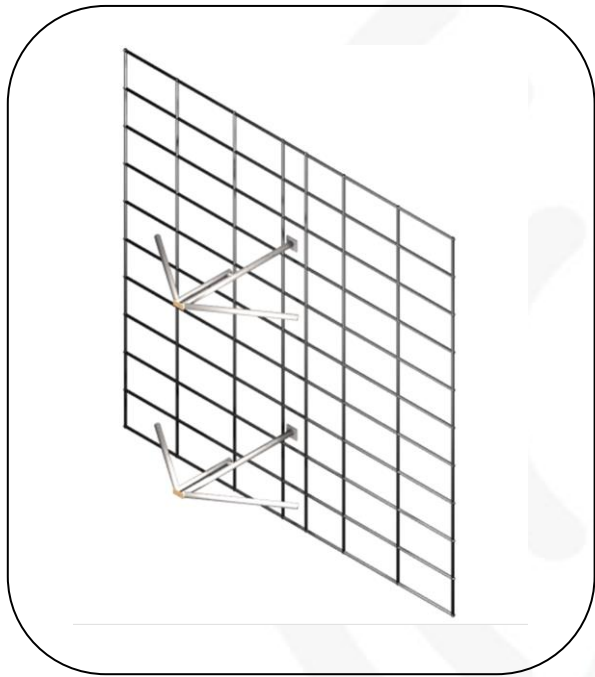

Features

- Horizontal Polarization
- Elliptical Polarization
- Circular Polarization
- Multi-Channel Systems
- Omni & Directional Systems
- High Power Input Ratings
- Optional Radomes

Specifications:

Band	VHF I & VHF III	<i>Connections Available: EIA: 3-1/8" EIA, 4-1/16", 6-1/8"</i>
Model	TV-P-C , TV-P-E, TV-P-H	
Input Power Rating	5 KW - 30kW	
Polarization	Horizontal, Elliptical, Circular	
Impedance	50 ohm	
Azimuth	±2dB free space	
VSWR	1.14:1 or better, Typical 1.08:1	

- > 40 KW ratings available upon engineering review.
- Standard mounting brackets and attachment hardware included with each antenna system. Custom mounting brackets available upon review.
- Antenna weight and wind load are approximate values for a typical structure. Final design loads may vary for the specific application.



STL Antenna Systems

STL 950 MHz Full Parabolic Antenna Systems

Features



- 870 – 960 MHz
- Broadband Systems
- 4 ft. , 6 ft. , & 8 ft. Systems
- High-Quality Aluminum, Brass, and Copper Materials

Specifications:

Frequency Range	870 – 960 MHz
Bandwidth	20 – 70 MHz
Gain	18.5 dBi (4 ft.), 21.5 dBi (8 ft.)
Front-to-Back Ratio	> 30 dB
Impedance	50 ohms
Input Power Rating	100 W
Beamwidth (Half-Power)	17degrees, 12 degrees, 9 degrees
Polarization	Horizontal, Vertical
VSWR	1.30 : 1 (or better)
Connections Available	Type N, 7/16 DIN, 7/8" EIA Flange

Standard Models:

Model	Power Rating	Gain	Weight
	watts	dBi	lbs.
STL-FP-4	100	18.5	24 lbs.
STL-FP-6	100	21.5	31 lbs.
STL-FP-8	100	24.0	46 lbs.

Notes:

- Includes standard mounting brackets and attachment hardware.
- Antenna weight and wind load calculations are approximate values for a typical structure. Final design loads may vary for the specific application.

Disclaimer: Specifications are subject to change without notice. Information may be changed or updated without notice. American Amplifier Technologies™ may also make improvements and/or changes in the products and/or pricing described at any time without notice.

STL 950 MHz Full Parabolic Antenna Systems

MODEL	DESCRIPTION
STL-FP-4	4 ft. STL 950 MHz Full Parabolic Antenna System
STL-FP-6	6 ft. STL 950 MHz Full Parabolic Antenna System
STL-FP-8	8 ft. STL 950 MHz Full Parabolic Antenna System

Coaxial and Rigid Line Products



Products Available

- Transmission Line
- Coaxial Line
- Connectors
- Adapters
- Directional Couplers
- Hybrid Combiners/Power Dividers
- Control Systems



Coaxial Products



*Rigid Transmission Line
and Components*

Transmission Line, Coaxial Line, and Connectors:

- | | |
|----------------------------------|--|
| • <i>Coaxial Line</i> | • <i>Coaxial and Rigid Connectors</i> |
| • <i>Rigid Transmission Line</i> | • <i>Rigid Cut Pieces, User Defined Length</i> |
| • <i>Patch Panels</i> | • <i>Quarter Wave Stub Rigid Filter Networks</i> |
| • <i>Coaxial Switches</i> | |

Adapters and Couplers:

- | | |
|--|---|
| • <i>Rigid Couplers</i> | • <i>Adapters</i> |
| • <i>Directional Couplers (Multi-Directional Ports and Sample Ports)</i> | • <i>Supporting Hardware and Brackets</i> |

Power Combiners and Splitters:

- | | |
|---|--|
| • <i>Unbalanced, Balanced, and Hybrid Combiners</i> | • <i>Antenna and Combiner/Power-Divider Transformers</i> |
|---|--|

Control Systems:

- *Customer User-Specified Control Systems and Interface*

Disclaimer: Specifications are subject to change without notice. Information may be changed or updated without notice. American Amplifier Technologies™ may also make improvements and/or changes in the products and/or pricing described at any time without notice.

Rigid Transmission Line

AAT Rigid Transmission Line and components are available in sizes from 7/8" up to 6-1/8" with both flanged and unflanged ends. Elbows, Field Flanges, Patch Panels and Reducers also available.

Available Sizes:

- 7/8" Rigid Transmission Line and Components
- 1 5/8" Rigid Transmission Line and Components
- 3 1/8" Rigid Transmission Line and Components
- 4 1/16" Rigid Transmission Line and Components
- 6 1/8" Rigid Transmission Line and Components

7/8" Rigid Transmission Line and Components

MODEL	DESCRIPTION
078-50-20UF	7/8" x 20 ft. Line Section, Unflanged
078-50-201F	7/8" x 20 ft. Line Section, Flanged One End
078-50-202F	7/8" x 20 ft. Line Section, Flanged Both Ends
078-50-90F	7/8", 90° Elbow, Flanged
078-50-90UF	7/8", 90° Elbow, Unflanged
078-50-TF	7/8" Tee Assembly, Flanged
078-50-GB	7/8" Gas Barrier
078-50-GBP	7/8" Gas Barrier with Gas Port
078-50-AIC	7/8" Anchor Insulator Connector (bullet)
078-50-FFSS	7/8" Field Flange (soft solder)
078-50-FFCT	7/8" Field Flange (clamp type)
078-50-UCIC	7/8" Unpressurized Coupling with Inner Conductor
078-50-UC	7/8" Unpressurized Coupling Without Inner Conductor
078-50-HDW	7/8" Hardware Set
078-50-CP	7/8" Cover Plate
078-50-SOR	7/8" Silicone O-Ring
078-50-FXF	7/8" Fixed Flange
078-50-SFL	7/8" Swivel Flange (2 Part)
078-50-COG	7/8" Cut-Off Guide
078-50-3PP1U	7/8" 3-Port Patch Panel with 1 U-Link
078-50-4PP2U	7/8" 4-Port Patch Panel with 2 U-Links
078-50-5PP2U	7/8" 5-Port Patch Panel with 2 U-Links
078-50-6PP3U	7/8" 6-Port Patch Panel with 3 U-Links
078-50-7PP3U	7/8" 7-Port Patch Panel with 3 U-Links
078-50-ULNK	7/8" U-link
078-50-INLS	7/8", Interlock switch
078-50-RFMNF	Reducer, 7/8" Fl. Male to Type N Female
078-50-RFMNM	Reducer, 7/8" Fl. Male to Type N Male
078-50-RFF716M	Reducer, 7/8" Female Flange to DIN-716 Male
078-50-RFF716F	Reducer, 7/8" Female Flange to DIN-716 Female

1 5/8" Rigid Transmission Line and Components

MODEL	DESCRIPTION
158-50-20UF	1-5/8" 20 ft. Line Section, Unflanged
158-50-201F	1-5/8" 20 ft. Line Section, Flanged One End
158-50-202F	1-5/8" 20 ft. Line Section, Flanged Both Ends
158-50-90FR	1-5/8" 90° Elbow Flanged
158-50-90UF	1-5/8" 90° Elbow Unflanged
158-50-45F	1-5/8" 45° Elbow Flanged
158-50-45UF	1-5/8" 45° Elbow Unflanged
158-50-90FUL	1-5/8" 90° Elbow Flanged Unequal Leg
158-50-TAF	1-5/8" Tee Assembly, Flanged
158-50-GB	1-5/8" Gas Barrier
158-50-AIC	1-5/8" Anchor Insulator Connector (bullet)
158-50-FFSS	1-5/8" Field Flange (soft solder)
158-50-FFCT	1-5/8" Field Flange (clamp type)
158-50-UCIC	1-5/8" Unpressurized Coupling with Inner Conductor
158-50-UC	1-5/8" Unpressurized Coupling without Inner Conductor
158-50-HDW	1-5/8" Hardware Set
158-50-CP	1-5/8" Cover plate
158-50-SOR	1-5/8" Silicone O-Ring
158-50-FXF	1-5/8" Fixed Flange
158-50-SFL	1-5/8" Swivel Flange (2 Part)
158-50-3PP1U	1-5/8" 3-Port PP with One U-Link
158-50-3PP1U2S	1-5/8" 3-Port PP with One U-Link and Two Switches
158-50-4PP2U	1-5/8" 4-Port PP with Two U-Links
158-50-4PP2U3S	1-5/8" 4-Port PP with Two U-Links and Three Switches
158-50-5PP2U	1-5/8" 5-Port PP with Two U-Links
158-50-5PP3U4S	1-5/8" 5-Port PP with Two U-Links and Four Switches
158-50-6PP3U	1-5/8" 6-Port PP with Three U-Links
158-50-6PP3U5S	1-5/8" 6-Port PP with Three U-Links and Five Switches
158-50-7PP3U	1-5/8" 7-Port PP with Three U-Links
158-50-7PP3U6S	1-5/8" 7-Port PP with Three U-Links and Six Switches
158-50-UL	1-5/8" U-link
158-50-ULIS	1-5/8" U-Link Interlock Switch
158-50-RMFNF	Reducer, 1-5/8" Male Flange to Type N Female
158-50-RMFNM	Reducer, 1-5/8" Male Flange to Type N Male
158-50-RFNF	Reducer, 1-5/8" Female to Type N Female
158-50-RM78MUC	Reducer, 1-5/8" Male to 7/8" Male, Unflanged with Couplings
158-50-RF78FUF	Reducer, 1-5/8" Female to 7/8" Female, Unflanged without Couplings
158-50-RM78M	Reducer, 1-5/8" Male to 7/8" Male, Flanged, Plate Reducer
158-50-RF78MF	Reducer, 1-5/8" Female to 7/8" Male, Flanged
158-50-RFF716M	Reducer, 1-5/8" Female Flange to DIN-716 Male
158-50-RFF716F	Reducer, 1-5/8" Female Flange to DIN-716 Female
158-50-WAP	1-5/8" Wall Anchor Plate
158-50-SH7SM	1-5/8" Slip Hanger 7" Stud Mounted
158-50-IHHS	1-5/8" Indoor Horizontal Hanger Single Line
158-50-SHSM	1-5/8" Slip Hanger Stud Mount

158-50-LB	1-5/8" Lateral Brace
158-50-COG	1-5/8" Cut Off Guide
158-50-VSHSL	1-5/8" Vertical Spring Hanger, Single Line
158-50-TTFH	1-5/8" Tower Top Fixed Hanger



3 1/8" Rigid Transmission Line and Components

MODEL	DESCRIPTION
318-50-20UF	3-1/8" x 20 ft. Line Section, Unflanged
318-50-201F	3-1/8" x 20 ft. Line Section, Flanged One End
318-50-202F	3-1/8" x 20 ft. Line Section, Flanged Both Ends
318-50-90FR	3-1/8" 90° Elbow, Flanged
318-50-90UF	3-1/8" 90° Elbow, Unflanged
318-50-90UFIC	3-1/8" 90° Elbow, Unflanged with Integrated Couplings
318-50-45F	3-1/8" 45° Elbow, Flanged
318-50-45UF	3-1/8" 45° Elbow, Unflanged
318-50-90ULF	3-1/8" 90° Elbow, Unequal Leg, Flanged
318-50-TA	3-1/8" Tee Assembly
318-50-GB	3-1/8" Gas Barrier
318-50-AIB	3-1/8" Anchor Insulator (bullet)
318-50-AIE	3-1/8", Anchor Insulator (expansion)
318-50-FFSS	3-1/8" Field Flange (soft solder)
318-50-FFCT	3-1/8" Field Flange (clamp type)
318-50-UCIC	3-1/8" Unpressurized Coupling with Inner Conductor
318-50-UC	3-1/8" Unpressurized Coupling without Inner Conductor
318-50-HDW	3-1/8" Hardware Set
318-50-CP	3-1/8" Cover Plate
318-50-SOR	3-1/8" Silicone O-Ring
318-50-FF	3-1/8" Fixed Flange
318-50-SF	3-1/8" Swivel Flange (2 Part)
318-50-3PP1U	3-1/8" 3-Port Patch Panel with One U-Link
318-50-4PP2U	3-1/8" 4-Port Patch Panel with Two U-Links
318-50-5PP2U	3-1/8" 5-Port Patch Panel with Two U-Links
318-50-6PP3U	3-1/8" 6-Port Patch Panel with Three U-Links
318-50-7PP3U	3-1/8" 7-port Patch Panel with Three U-Links
318-50-UL	3-1/8" U-Link
318-50-ULIS	3-1/8" U-Link Interlock Switch
318-50-RMNF	Reducer, 3-1/8" Male to Type-N Female
318-50-RMNM	Reducer, 3-1/8" Male to Type-N Male
318-50-310RM78FF	Reducer, 3-1/8" Male to 7/8" Female, Flanged
318-50-RFF78FF	Reducer, 3-1/8" Female to 7/8" Female, Flanged
318-50-M158MUC	Reducer, 3-1/8" Male to 1-5/8" Male, Unflanged with Couplings
318-50-F158FU	Reducer, 3-1/8" Female to 1-5/8" Female, Unflanged without Couplings
318-50-F158F	Reducer, 3-1/8" Female to 1-5/8" Male, Flanged
318-50-M158M	Reducer, 3-1/8" Male to 1-5/8" Male, Flanged, Plate Reducer
318-50-WAP	3-1/8" Wall Anchor Plate
318-50-WAPDL	3-1/8" Wall Anchor Plate, Dual Line
318-50-IHHSLS	3-1/8" Indoor Horizontal Hanger, Single Line
318-50-SHSM	3-1/8" Slip Hanger, Stud Mount
318-50-LB	3-1/8" Lateral Brace
318-50-COG	3-1/8" Cut Off Guide
318-50-VSHSL	3-1/8" Vertical Spring Hanger, Single Line
318-50-TTFHSL	3-1/8" Tower Top Fixed Hanger, Single Line
318-50-3PHSHSL	3-1/8" 3-Point Horizontal Suspension Hanger, Single Line

4 1/16" Rigid Transmission Line and Components

MODEL	DESCRIPTION
416-50-20UF	4-1/16" x 20 ft. Line Section, Unflanged
416-50-201F	4-1/16" x 20 ft. Line Section, Flanged One End
416-50-202F	4-1/16" x 20 ft. Line Section, Flanged Both Ends
416-50-90FR	4-1/16" 90° Elbow, Flanged
416-50-90UF	4-1/16" 90° Elbow, Unflanged
416-50-45F	4-1/16" 45° Elbow, Flanged
416-50-45UF	4-1/16" 45° Elbow, Unflanged
416-50-90ULF	4-1/16" 90° Elbow, Unequal Leg Flanged
416-50-TA	4-1/16" Tee Assembly
416-50-GB	4-1/16" Gas Barrier
416-50-AIB	4-1/16" Anchor Insulator (bullet)
416-50-AIC	4-1/16", Anchor Insulator Connector (expansion)
416-50-FFSS	4-1/16", Field Flange (soft solder)
416-50-FFCT	4-1/16" Field Flange (clamp type)
416-50-UCIC	4-1/16" Unpressurized Coupling with Inner Conductor
416-50-UC	4-1/16" Unpressurized Coupling without Inner Conductor
416-50-HDW	4-1/16" Hardware Set
416-50-CP	4-1/16" Cover Plate
416-50-SOR	4-1/16" Silicone O-Ring
416-50-FF	4-1/16" Fixed Flange
416-50-SF	4-1/16" Swivel Flange (2 Part)
416-50-ABTWTHWI	4-1/16" Adaptor Bullet, Thin Wall to Thick Wall Inners
416-50-3PP1U	4-1/16" 3-Port Patch Panel with 1 U-Link
416-50-4PP2U	4-1/16" 4-Port Patch Panel with 2 U-Links
416-50-5PP2U	4-1/16" 5-Port Patch Panel with 2 U-Links
416-50-6PP3U	4-1/16" 6-Port Patch Panel with 3 U-Links
416-50-7PP3U	4-1/16" 7-port Patch Panel with 3 U-Links
416-50-UL	4-1/16" U-Link
416-50-IS	4-1/16" Interlock Switch
416-50-RFMNF	Reducer, 4-1/16" Fl. Male to Type-N Female
416-50-RFMNM	Reducer, 4-1/16" Fl. Male to Type-N Male
416-50-RUM158UMC	Reducer, 4-1/16" Unfl. Male to 1-5/8" Unfl. Male with Couplings
416-50-RUFUF	Reducer, 4-1/16" Unfl. Female to 1-5/8" Unfl. Female (no couplings)
416-50-RFFFM	Reducer, 4-1/16" Fl. Female to 1-5/8" Fl. Male
416-50-RUM318UMC	Reducer, 4-1/16" Unfl. Male to 3-1/8" Unfl. Male with Couplings
416-50-RUF318UF	Reducer, 4-1/16" Unfl. Female to 3-1/8" Unfl. Female (no couplings)
416-50-FF318FM	Reducer, 4-1/16" Fl. Female to 3-1/8" Fl. Male
416-50-WAP	4-1/16" Wall Anchor Plate
416-50-IHHSLS	4-1/16" Indoor Horizontal Hanger, Single Line
416-50-3PHSHSL	4-1/16" 3-Point Horizontal Suspension Hanger, Single Line
416-50-FHSLV	4-1/16" Fixed Hanger, Single Line Vertical
416-50-LB	4-1/16" Lateral Brace
416-50-VSHSL	4-1/16" Vertical Spring Hanger, Single Line
416-50-COG	4-1/16" Cut Off Guide

6 1/8" Rigid Transmission Line and Components

MODEL	DESCRIPTION
618-50-20UF	6-1/8" x 20 ft. Line Section, Unflanged
618-50-201F	6-1/8"x 20 ft. Line Section, Flanged one end
618-50-202F	6-1/8" x 20 ft. Line Section, Flanged both ends
618-50-90FR	6-1/8" 90° Elbow, Flanged
618-50-90UF	6-1/8" 90° Elbow, Unflanged
618-50-45F	6-1/8" 45° Elbow, Flanged
618-50-45UF	6-1/8" 45° Elbow, Unflanged
618-50-ULF	6-1/8" 90° Elbow, Unequal Leg Flanged
618-50-TA	6-1/8" Tee Assembly
618-50-GB	6-1/8" Gas Barrier
618-50-AICB	6-1/8" Anchor Insulator Connector (bullet)
618-50-AICE	6-1/8" Anchor Insulator Connector (expansion)
618-50-FFSS	6-1/8" Field Flange (soft solder)
618-50-FFCT	6-1/8" Field Flange (clamp type)
618-50-UC	6-1/8" Unpressurized Coupling without Inner Conductor
618-50-UCIC	6-1/8" Unpressurized Coupling with Inner Conductor
618-50-HDW	6-1/8" Hardware Set
618-50-CP	6-1/8" Cover Plate
618-50-SOR	6-1/8" Silicone O-Ring
618-50-FF	6-1/8" Fixed Flange
618-50-SF	6-1/8" Swivel Flange (2 Part)
618-50-3PP1U	6-1/8" 3-Port Patch Panel with One U-Link
618-50-4PP2U	6-1/8" 4-Port Patch Panel with Two U-Links
618-50-5PP2U	6-1/8" 5-Port Patch Panel with Two U-Links
618-50-6PP3U	6-1/8" 6-Port Patch Panel with Three U-Links
618-50-7PP3U	6-1/8" 7-Port Patch Panel with Three U-Links
618-50-UL	6-1/8" U-Link
618-50-IS	6-1/8" Interlock Switch
618-50-RFMNF	Reducer, 6-1/8" Fl. Male to Type-N Female
618-50-RFMNM	Reducer, 6-1/8" Fl. Male to Type-N Male
618-50-RFF78M	Reducer, 6-1/8" Fl. Female to 7/8" Male
618-50-RFF158M	Reducer, 6-1/8" Fl. Female to 1-5/8" Male
618-50-RFF318FM	Reducer, 6-1/8" Fl. Female to 3-1/8" Fl. Male
618-50-RUM318UM	Reducer, 6-1/8" Unfl. Male to 3-1/8" Unfl. Male
618-50-RFF4116FM	Reducer, 6-1/8" Fl. Female to 4-1/16" Fl. Male
618-50-RUM4116UM	Reducer, 6-1/8" Unfl. Male to 4-1/16" Unfl. Male
618-50-RFF412FM	Reducer, 6-1/8" Fl. Female to 4-1/2" Fl. Male
618-50-RUM412UM	Reducer, 6-1/8" Unfl. Male to 4-1/2" Unfl. Male
618-50-WAP	6-1/8" Wall Anchor Plate
618-50-IHHSLS	6-1/8" Indoor Horizontal Hanger, Single Line
618-50-FHSLV	6-1/8" Fixed Hanger, Single Line Vertical
618-50-LB	6-1/8", Lateral Brace
618-50-VSHSL	6-1/8" Vertical Spring Hanger, Single Line
618-50-COG	6-1/8" Cut Off Guide



Coaxial Line Products

Coaxial Line Product

RG11 Coax:

MODEL	DESCRIPTION
AAT-RG11	RG11 Coaxial line. 75 ohm.

RG11 Coax Connectors:

MODEL	DESCRIPTION
RG11-TYPEFM	RG11 Type-F male connector. Compression
RG11-TK	RG11 Cutting and Connector Crimp Tool Kit

LMR400 3/8" Coax:

MODEL	DESCRIPTION
LMR400-C	LMR400 50 ohm coax

LMR400 3/8" Coax Connectors:

MODEL	DESCRIPTION
TYPENF-LMR400	Type N Female connector for LMR400 coax
TYPENM-LMR400	Type N Male connector for LMR400 coax

1/2" Standard Coax:

MODEL	DESCRIPTION
AAT-12-COAX-F	1/2" Standard 50 Ohm Foam Coax

1/2" Standard Coax Connectors:

MODEL	DESCRIPTION
N-M-12 Female	Type N Female coax connector for 1/2" standard foam coax cable
N-M-12 Male	Type N Male coax connector for 1/2" standard foam coax cable
716-12C	7/16" DIN Male Coax Connector for standard 1/2" coax
716-12C-90	7/16" DIN Male coax connector for standard 1/2" coax, 90 degree connector
78-EIA-12-CC	7/8" EIA connector for standard 1/2" foam coax. Includes hardware kit and o-ring

1/2" Super Flex Coax:

MODEL	DESCRIPTION
AAT-12-COAX-SF	1/2" Super Flex 50 Ohm Foam Coax

1/2" Super Flex Coax Connectors:

MODEL	DESCRIPTION
AAT-N-M-12-SF	Type N Male coax connector for 1/2" super flex foam coax cable
AAT-N-M-12-SF-90	Type N Male coax connector. 90 degree, for 1/2" super flex foam coax cable
AAT-716-12C-SF	7/16" DIN Male Coax Connector for super flex 1/2" coax
AAT-716-12C-SF-90	7/16" DIN Male 90 degree Coax Connector for super flex 1/2" coax

7/8" Foam Coax:

MODEL	DESCRIPTION
AAT-78-COAX-F	7/8" 50 Ohm Foam Coax

7/8" Foam Coax Connectors:

MODEL	DESCRIPTION
AAT-78-CC-78-AAT	7/8" EIA coax connector for 7/8" foam cable - AAT 7/8" coax
AAT-78-CC-78-RSB	7/8" EIA coax connector for 7/8" foam cable - Rosenberger 7/8" coax
AAT-78-CC-78-LCF78-50	7/8" EIA coax connector for 7/8" foam cable - RFS LCF78-50
AAT-78-CC-78-AVA5-50	7/8" EIA coax connector for 7/8" foam cable - Commscope AVA5-50
AAT-78-CC-78-LDF5-50A	7/8" EIA coax connector for 7/8" foam cable - Andrew LDF5-50A
AAT-78-CC-78-EC5-50-A	7/8" EIA coax connector for 7/8" foam cable - Eupen EC5-50-A
AAT-716-78C	7/16" DIN Male coax connector for 7/8" foam cable - AAT 7/8 coax

7/8" Air Pass Coax:

MODEL	DESCRIPTION
AAT-78-AC	7/8" 50 Ohm Air Pass

7/8" Air Pass Connectors:

MODEL	DESCRIPTION
AAT-78-CC-78-CA	7/8" EIA coax connector for 7/8" air pass coax

1-5/8" Foam Coax:

MODEL	DESCRIPTION
AAT-158-FC	1-5/8" 50 Ohm Foam Coax

1-5/8" Foam Coax Connectors:

MODEL	DESCRIPTION
158-EIA-158-C	1-5/8" EIA connector for 1-5/8" foam coax cable AAT Coax
158-EIA-158-C-AVA7-50	1-5/8" EIA connector for 1-5/8" foam coax cable Andrew AVA7-50
158-EIA-158-C-LDF7-50A	1-5/8" EIA connector for 1-5/8" foam coax cable Andrew LDF7-50A
158-EIA-158-C-LCF158-50A	1-5/8" EIA connector for 1-5/8" foam coax cable RFS LCF158-50A

1-5/8" Air Pass Coax:

MODEL	DESCRIPTION
AAT-158-AC	1-5/8" 50 Ohm Air Pass

1-5/8" Air Pass Connectors:

MODEL	DESCRIPTION
158-EIA-158-CA	1-5/8" EIA connector for 1-5/8" Air Pass Coax

3" Air Pass Coax:

MODEL	DESCRIPTION
AAT-HC318-AC	3-1/8" 50 ohm Air Coax

3" Air Pass Coax Connectors:

MODEL	DESCRIPTION
HC318-AC-318C	3-1/8" EIA connector for 3" air coax

4" Air Pass Coax:

MODEL	DESCRIPTION
HC40-AC-4C	4" 50 Ohm Air Coax

4" Air Pass Coax Connectors:

MODEL	DESCRIPTION
HC40-AC-318C	4" 50 Ohm Air 3-1/8" coax connector

5" Air Pass Coax

MODEL	DESCRIPTION
HC50-AC-5C	5" 50 Ohm Air Coax

5" Air Pass Coax Connector

MODEL	DESCRIPTION
HC50-AC-618C	5" 50 Ohm Air 6-1/8" Coax Connector



60/60 Hz Single Phase to Three Phase Converters



5 – 300 HP Phase Converters



Specifications:

Models	AD, ADX, AUL
Horsepower	5 – 300 hp
Input Voltage (Single Phase)	208-250
Efficiency	>98%
Idler RPM	1750
Operating Reliability	MTBF 50000

Controller Options

AD – The AD model is built with our MicroSmart Controller that will monitor the voltage every millisecond to ensure your equipment has the right voltage all the time. This MicroSmart controller provides precise control of the phase converter which provides better voltage balance and prolonged life of the converter. Our AD Model is perfect for voltage sensitive medium duty loads such as CNC Equipment, EDM Machines, Welders, Ovens, etc. These types of equipment require precise voltage balance making the AD your perfect solution.

ADX - Our ADX Model includes all the features and benefits of our AD Model but also has our Current Transient Reactor (also known as CTR) in it. This CTR Controller, along with our MicroSmart Controller, allows higher amounts of current to be drawn through the phase converter. This produces more torque while maintaining voltage and power with precision for sensitive equipment. These ADX Models are perfect for hard starting loads such as Air Compressors, HVAC, Refrigeration and equipment such as Wide Belt Sanders that have a long start time to get up to speed.

AUL - Our AUL unit comes with all the benefits and features of our ADX model with added components to not only meet, but exceed UL safety guidelines. These units come UL certified with the appropriate documentation. UL certification is not required in all locations or installations so please check with your local inspectors to see if the AUL model is the right unit for you.

Features

Control Panel

- Push Button ON/OFF Switch w/ PowerGuard Protection
- Heavy Duty Performance, 100% Power
- Powder-Coated Steel Enclosures for an attractive and durable appearance
- Integrated Protection in case of power interruption
- Easy access terminal block wiring connections
- Best Warranty in the Industry

Optional Upgrades

Floor Mount | 3PH Breaker | 3PH Receptacle | Surge Protection | Wired or Wireless Remote Switch | Automation Control* | Phase Monitoring* | 480V-Special Order* | Outdoor or see our AI Series* Control Panel Idler / Generator Optional Upgrades

Idler / Generator

- Designed and engineered specifically for phase conversion
- Achieve optimized voltage and current balance throughout the full load of the converter
- Soft Start Rating by drastically reducing in-rush current upon startup
- Runs cool, quietly and efficiently with or without load applied
- Manufactured in the USA by Baldor Electric

AI Phase Converters



Specifications:

Models	AI-20, AI-30, AI-40, AI-50, AI-60, AI-75, AI-100, AI-150, AI-200, AI-300
Horsepower	20 – 300HP
Input Voltage (Single Phase)	208-250
Efficiency	>98%
Idler RPM	1750
Operating Reliability	MTBF 50000

Features

- Nema 3R/Type 3R - which allows this unit to be mounted anywhere and in any type of elements. Rain...snow...you are protected!
- American Rotary's illuminated rotary switch makes it easy to start or stop your unit. The two light indicators are a quick reference on your single phase input and start circuit operation.
- Super Quiet with our Baldor Induction Generator making this unit perfect for an indoor or outdoor application. The American Rotary/Baldor VIT Generator is protected with a patent pending custom built NEMA 3R enclosure. American Rotary's proprietary design allows for easy plug and play with your three phase equipment.
- Available in 240V or 480V and from ratings of 20-300HP
- American Rotary's heavy duty mounting base is strong and functional. They allow you to easily move the unit with a forklift, mount the device to concrete pad or floor and keep the unit off the ground and away from any moisture.
- Easy to remove and wash down filter, this filter will protect against dust, dirt and other harmful particles protecting your VIT generator and keeping you running at peak efficiencies.

Phase Converters

Voltage and mount configuration specified upon order

MODEL	DESCRIPTION
AD-05	AD Digital Smart Series Phase Converter 2 HP
AD-10	AD Digital Smart Series Phase Converter 5 HP
AD-15	AD Digital Smart Series Phase Converter 7.5 HP
AD-20	AD Digital Smart Series Phase Converter 10 HP
AD-25	AD Digital Smart Series Phase Converter 12.5 HP
AD-30	AD Digital Smart Series Phase Converter 15 HP
AD-40	AD Digital Smart Series Phase Converter 20 HP
AD-50	AD Digital Smart Series Phase Converter 25 HP
AD-60	AD Digital Smart Series Phase Converter 30 HP
AD-75	AD Digital Smart Series Phase Converter 40 HP
ADX-05	ADX Extreme Duty Smart Series Phase Converter 2 HP
ADX-10	ADX Extreme Duty Smart Series Phase Converter 5 HP
ADX-15	ADX Extreme Duty Smart Series Phase Converter 7.5 HP
ADX-20	ADX Extreme Duty Smart Series Phase Converter 10 HP
ADX-25	ADX Extreme Duty Smart Series Phase Converter 12.5 HP
ADX-30	ADX Extreme Duty Smart Series Phase Converter 15 HP
ADX-40	ADX Extreme Duty Smart Series Phase Converter 20 HP
ADX-50	ADX Extreme Duty Smart Series Phase Converter 25 HP
ADX-60	ADX Extreme Duty Smart Series Phase Converter 30 HP
ADX-75	ADX Extreme Duty Smart Series Phase Converter 40 HP
ADX-100	ADX Extreme Duty Smart Series Phase Converter 50 HP
ADX-150	ADX Extreme Duty Smart Series Phase Converter 75 HP
ADX-200	ADX Extreme Duty Smart Series Phase Converter 100 HP
ADX-300	ADX Extreme Duty Smart Series Phase Converter 150 HP

MODEL	DESCRIPTION
AI-20	AI Industrial Phase Converter 10 HP
AI-30	AI Industrial Phase Converter 15 HP
AI-40	AI Industrial Phase Converter 20 HP
AI-50	AI Industrial Phase Converter 25 HP
AI-60	AI Industrial Phase Converter 30 HP
AI-75	AI Industrial Phase Converter 40 HP
AI-100	AI Industrial Phase Converter 50 HP
AI-150	AI Industrial Phase Converter 75 HP
AI-200	AI Industrial Phase Converter 100 HP

 **American Amplifier Technologies, LLC**

American Amplifier Technologies provides a variety of services and products. We pride ourselves on providing quality products that are designed to operate with many years of superb performance. Our large inventory of broadcast products and professional staff allows us to fulfill the needs of the FM, TV, and AM broadcast industries.

Our staff includes design engineers that provide many years of broadcast and electrical engineering experience. Our staff is passionate about our products and services ensuring each project is completed to provide outstanding performance. AAT products are designed and produced with quality materials, simplicity, and rigorous engineering standards. Our years of experience and expertise allows for products and services that are quality investments to our customers. We look forward to providing excellent products and services for all broadcast and electrical engineering requirements.

© 2023 American Amplifier Technologies, LLC