

The world's leading CAN-based monitor and diagnostic display for engines and machinery

Compact size to fit your application

Superior sunlight viewability

Streamlined design

Detailed diagnostics

User Configurable Out-of-the-Box



THE SIMPLE SOLUTION FOR COMPLEX ELECTRONIC ENGINES

The PV101-R2 displays standard J1939 parameters and fault codes in an easy to understand language accessed via a backlit LCD display.

It can display up to four engine/transmission and auxiliary parameters simultaneously. It also features alarm and shut-down lights, along with detailed diagnostics.

With Tier 4 and Stage IV compliance, plus compatibility and software configuration options, the PV101-R2 is up to date with the latest customer requirements without sacrificing the ease of use that made it a success.

The PV101-R2 display is the industry standard, used by thousands of OEMs around the world. It's built tough, dependable and simply the best.

The PV101-R2 is the supersession to the PV101-C. The display boasts a larger screen, more tactile control buttons, and enhanced viewability. All core display functions, user interface, and core wiring remains the same.

POWerview® PV101-R2

1511625 01-2019

PV101-R2 DIMENSIONS

Please visit our Help Center for MLC380 dimensions

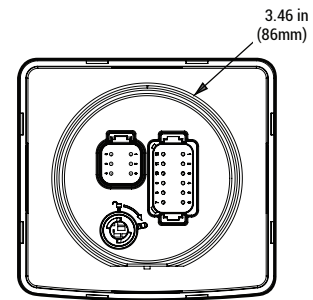
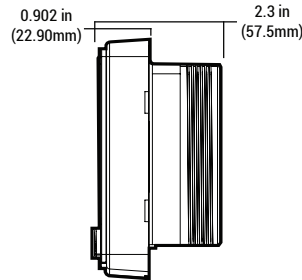
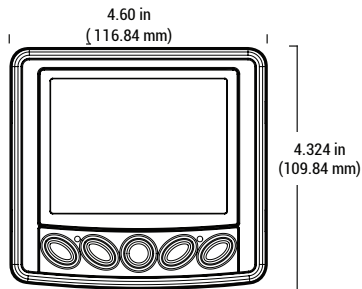

PV101-R2 SPECIFICATIONS

DISPLAY	
SCREEN SIZE	3.8 inches
TYPE	Monochrome transfective LCD with white LED backlight, heater and real-time clock
RESOLUTION	320 x 240
HARDWARE	
KEYPAD	5 tactile pushbuttons
ALARMS	(1) Red LED, warning (1) Amber LED, warning Setpoint triggered output for external piezo buzzer or shut-down relay
CONNECTORS	Deutsch DT Series 6 and 12 pin
COMMUNICATION	
CAN	(1) CAN 2.0B, J1939 Protocol; Proprietary Messaging
SERIAL	RS-485
ELECTRICAL	
OPERATING VOLTAGE	6-36 VDC; reverse polarity protected
INPUTS	(4) Resistive analog (3) Analog: 0-5V, 4-20mA analog or digital (1) Frequency 2-10,000Hz, 3.6-120VAC
OUTPUTS	(2) 500mA; switched low-side

ENVIRONMENTAL	
OPERATING TEMPERATURE	-40°C to 85°C (-40° to 185°F)
STORAGE TEMPERATURE	-40°C to 85°C (-40° to 185°F)
PROTECTION	IP66 and 67
VIBRATION	7.86g random vibrate (5-2,000Hz)
SHOCK	±50G in 3 axes
EMC/EMI	2004/108/EC, 2006/95/EC directives EN61000-6-4:2001 (emission) EN61000-6-2:2001 (immunity) EN 50121-3-2 and EN 12895
SAE	J1113/2, 4, 11, 12, 21, 24, 26 and 41

FOR MANUALS, SUPPORT DOCUMENTS, AND WIRING DIAGRAMS PLEASE VISIT:

www.macquarrie.com.au/collections/powerview-displays

UPGRADING FROM PV101-C TO PV101-R2

WIRING CONNECTIONS

The wiring for the PV101-R2 primary connection to CAN & Power is the same of the now discontinued PV101-C. If you require support in upgrading a PV101-C to the PV101-R2, please contact your distributor.

PV101-C WIRING (DISCONTINUED)

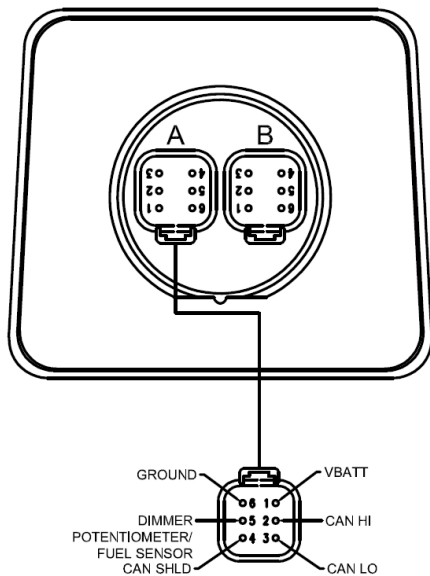

PV101-R2 WIRING

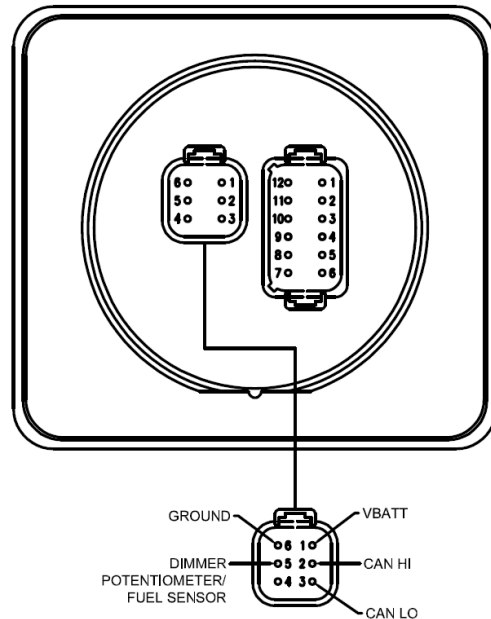

MOUNTING

The mounting for the PV101-R2 is a larger hole-size than the now-discontinued PV101-C. To upgrade from a PV101-C to a PV101-R2, the original mounting hole must be enlarged to Ø86mm

PV101-C MOUNTING (DISCONTINUED)

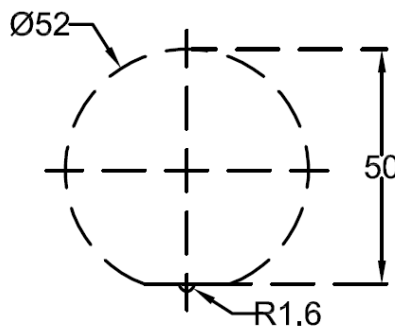

PV101-R2 MOUNTING

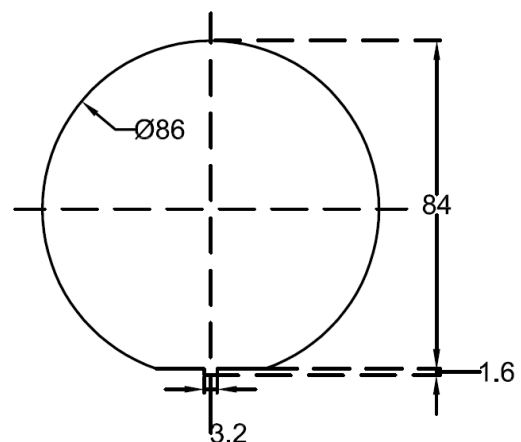

TYPICAL WIRING DIAGRAM

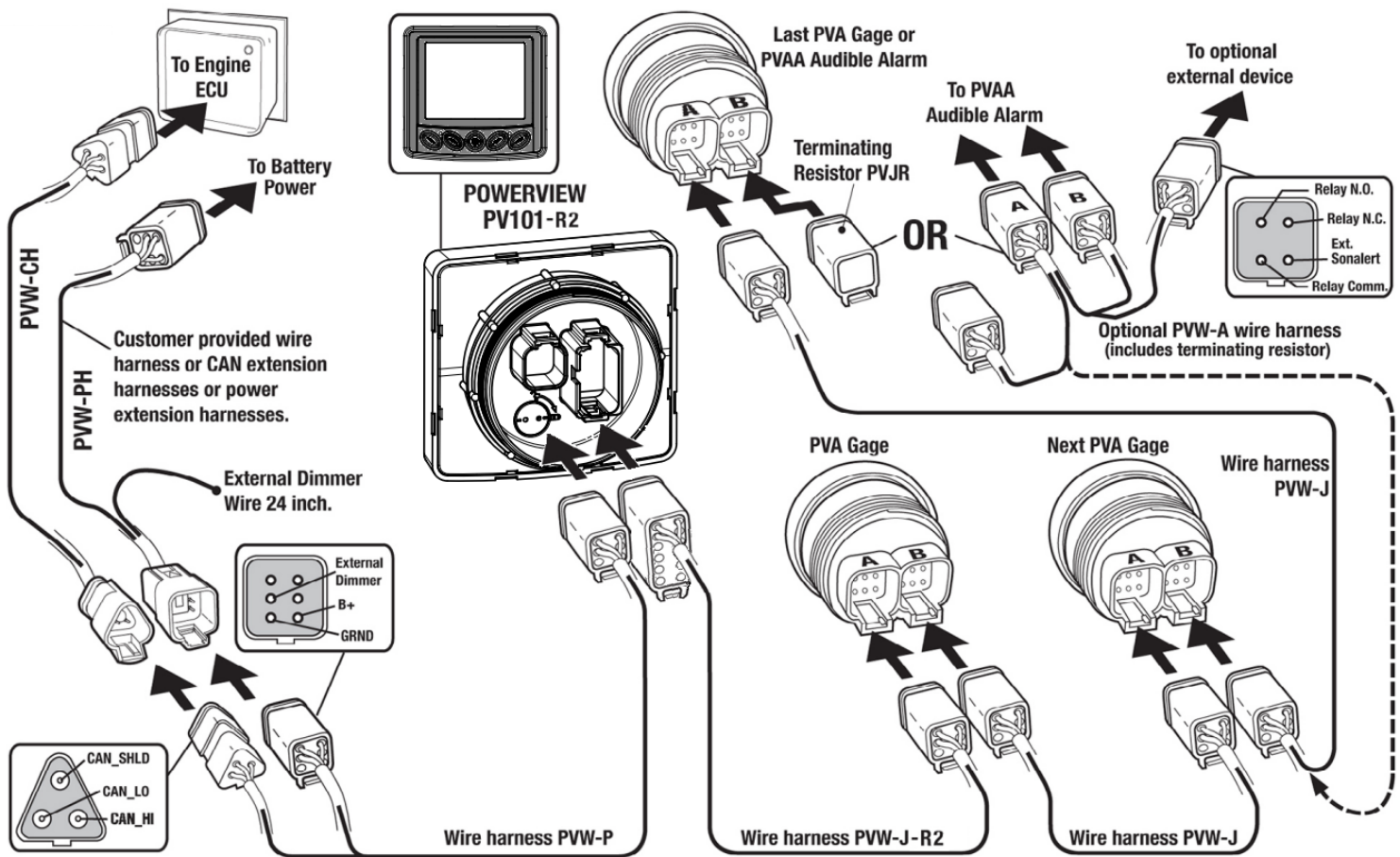

PV101-C TO PV101-R2 – PVA GAUGE WIRING CHANGE NOTIFICATION

The wiring for the connection between the PV101-R2 and the first PVA gauge has changed.

To upgrade from a PV101-C to a PV101-R2 – the first PVW-J harness must be swapped for a PVW-J-R2 harness.

All other connections remain the same, including other PVW-J harnesses connecting other PVA gauges in the daisy-chain.





PVW-J
PV101 to PVA jumper harness



PVW-J-R2
PV101-R2 to PVA jumper harness

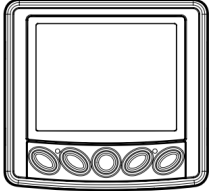
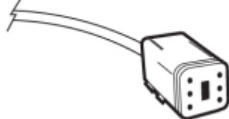

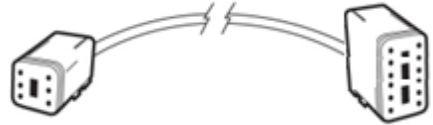
HOW TO ORDER

PART NUMBER	LENGTH	DESCRIPTION	DIAGRAM
0978PV101R2	-	PV101-R2 3.8" Monochrome Display	
0978PVWPW30	30 in (762mm)	PVW-PW CAN and power bare ends wiring (includes 120Ω CAN resistor)	
0978PVWP12	12 in (305mm)	PVW-P CAN and power harness	
0978PVWJ	12 in (305mm)	PVW-J: PVA jumper harness	
0978PVWJR2	12 in (305mm)	PVW-J-R2: PV101-R2 to PVA jumper harness	
0978PVWPH72	72 in (1.82m)	PVW-PH: PowerView battery Power extension harness	
0978PVWCH72	72 in (1.82m)	PVW-CH: PowerView CAN extension harness	
0978PVJR	-	PVJR: Terminating resister (use on last PVA gage in a series)	