

KEYBOX CANOPEN USER MANUAL



Features:

CANopen bus

12V or 24V power supply supported

13 power outputs (2 of which supporting PWM mode)

Operating temperature range: -20 to +70°C

Water proof (IP67)

Replaceable automotive mini blade fuses for overcurrent protection

Cinch connector SHS 18pin

THE PRESENT MANUAL IS FOR REFERENCE ONLY AND MIGHT BE NOT UP TO DATE TO THE LATEST VERSION. PLEASE CONTACT US FOR GETTING THE MOST UPDATED FILE

Table of content

1.	How to Connect CAN bus:	4
2.	Keybox Technical Specifications	4
3.	Mechanical dimensions	5
4.	Cinch Connector 18 pin:.....	6
5.	Electrical Loads Connection.....	7
6.	Pin Assignment.....	7
7.	Output State Machine Diagram	8
8.	CANopen Messages Structure.....	9
9.	CAN Messages for Managing Output Pins.....	11
10.	CAN bus Default Settings	11
	NMT MESSAGES	12
11.	Start CANopen Node	12
12.	Enter Pre-operational.....	12
13.	Reset CANopen Node.....	12
14.	Stop CANopen Node	13
15.	Boot-up Service	13
16.	Heartbeat Message	13
	PDO Messages.....	14
17.	Set Output (OFF and HIGH).....	14
18.	Fault Message.....	14
	SDO messages	15
19.	Object 2001h: Single Pin State.....	15
20.	Object 2003h: Read Digital Input.....	16
21.	Object 2008h: Output State	17
22.	Object 2009h: PWM State {future upgrade}.....	18
23.	Object 2010h: Baud rate settings.....	19
24.	Object 2011h: Set node ID	20
25.	Object 2012h: Set Periodic Messages	20
26.	Object 2013h: Set Device Active on Startup.....	21
27.	Object 2015h: Set Boot-up Service	21
28.	Object 1016h: Consumer Heartbeat Time	22

29.	Object 1017h: Producer Heartbeat Time	23
30.	Object 1000h: Device Type	23
31.	Object 1001h: Error Register	24
32.	Object 1008h: Manufacturer Device Name	24
33.	Object 1009h: Manufacturer Hardware Revision	24
34.	Object 100Ah: Manufacturer Firmware Revision	25
35.	Object 100Bh: Model ID	25
36.	Object 1011h: Restore default parameters	26
37.	Object 1018h: Identity object	26
38.	Object 1400h: Receive PDO 0 Communication Parameter	27
39.	Object 1600h: Receive PDO 0 Mapping Parameter	27
40.	Object 1800h: Transmit PDO 0 Communication Parameter	28
41.	Object 1A00h: Transmit PDO 0 Mapping Parameter	28
42.	Revision history	29

DRAFT

1. How to Connect CAN bus:

PIN	FUNCTION
D2	CAN L
E2	CAN H

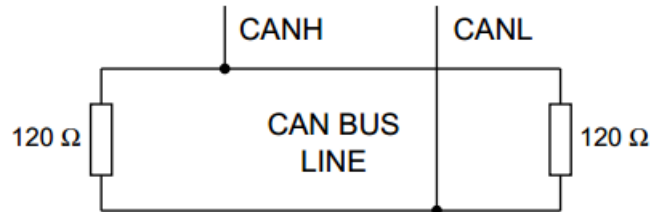

Each end of the CAN bus is terminated with 120Ω resistors in compliance with the standard to minimize signal reflections on the bus.

A 120Ω resistor between CAN-L and CAN-H is already mounted in the Keybox PCB, you may need to place a 120Ω resistor between CAN-L and CAN-H on the CANbus wire harness.

2. Keybox Technical Specifications

Electrical	Value	Unit
Supply Voltage (Battery Voltage)	9-16 (12V) or 18-31 (24V)	V
Maximum input current	120	A
Maximum current single pin	10 (12V) or 5 (24V)	A
Maximum Digital input voltage	Battery Voltage	V
Digital input low voltage max	5,5	V
Environmental	Value	Unit
Storage temperature range	-40 to +85	°C
Operating temperature range	-20 to +70	°C
Humidity	0 to 98	%

3. Mechanical dimensions

Dimensions are in millimeters.

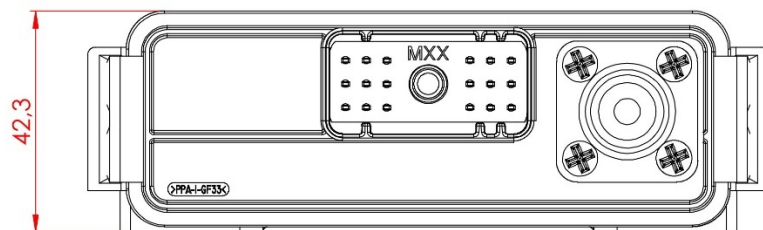
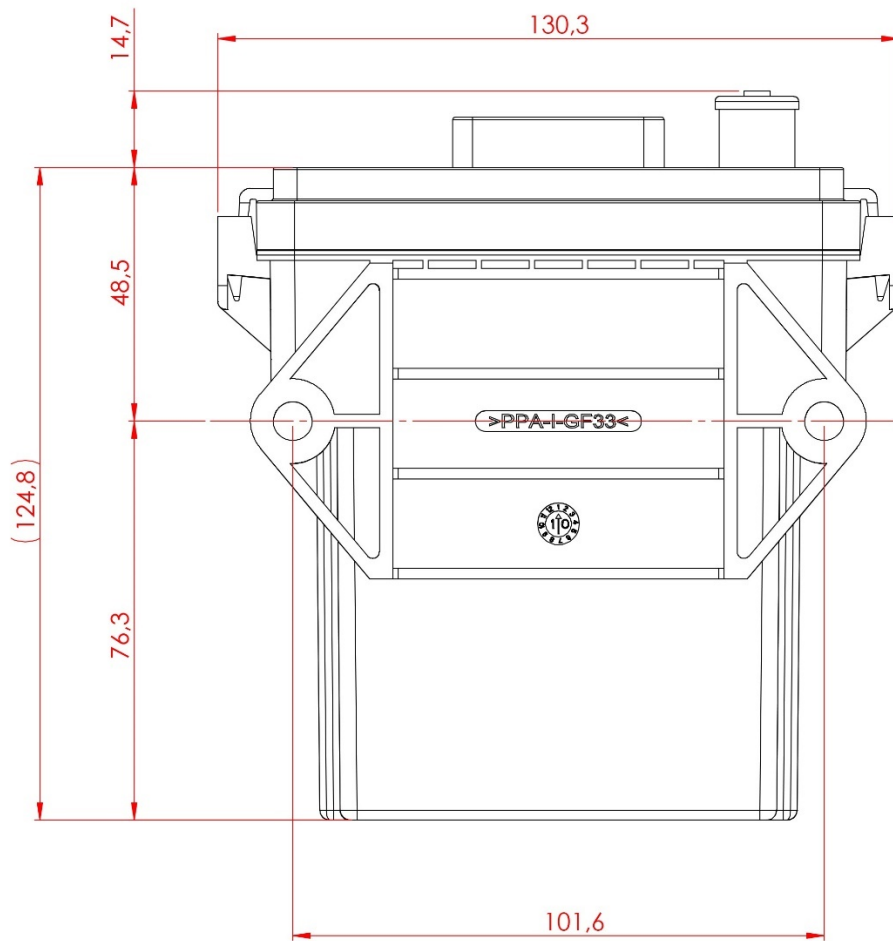

4. Cinch Connector 18 pin:

The 18pin Cinch header connector 5810118038 mates with Cinch harness connector 5810118023:

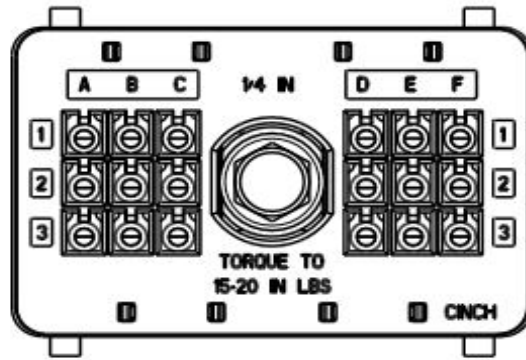

Output

Pin

Ch 6	A1
Ch 9	A2
Ch 10	A3
Ch 5	B1
TXRX-	B2
Ch 1	B3
Ch 4	C1
Ch 12	C2
TXRX+	C3
Ch 13	D1
CANL	D2
GND	D3
Ch 2	E1
CANH	E2
Ch 7	E3
Ch 3	F1
Ch 11	F2
Ch 8	F3

V_{BATT} supply connector: Amphenol SLPPA16BSO



5. Electrical Loads Connection

The device could be set to control from 1 to 13 outputs. Each output (except for PIN12 and PIN13 driven by a double channel Mosfet) is a contact of an on/off relay, open or closed to Vbatt. The relay of the output contacts Ch2 and Ch5 could be set to work as open or close to ground contacts. Depending on the requested application the number of relays mounted in the PCB can be customized in the range of 1 to 11. For the 12V version, the relays can be customized to operate at 10A or 5A max current.

The electrical load is connected between an output pin of the Keybox and ground, and it is ON when the corresponding pin state is HIGH.

If the contacts Ch2 and Ch5 are set as Low Side driver, the electrical load is connected between Vbatt and the output pin of the Keybox, and it is ON when the corresponding pin state is HIGH.

The output pin state can be HIGH (relay contacts shorted) or OFF (pin floating, relay contacts open).

The ground can be connected either to the ground pin of the Keybox or directly to the battery's negative pole. An automotive mini blade fuse protects the circuit. The fuse rate is set according to the customer needs from 1 to 10Amps. The fuses are mounted on fuse holders in order to be easily replaced.

6. Pin Assignment

Pin	Output	Function	Fuse Rating	Mosfet	Optional Low Side	Level Sense
A1	Ch6	O	FH6 max 10A			X
A2	Ch9	O	FH9 max 10A			X
A3	Ch10	O	FH10 max 10A			X
B1	Ch5	O	FH5 max 10A		X	X
B2	BUS	TXRX-	NA			
B3	Ch1	O	FH1 max 10A			X
C1	Ch4	O	FH4 max 10A			X
C2	Ch12	O	FH12 max 3A	X		X
C3	BUS	TXRX+	NA			
D1	Ch13	O	FH13 max 3A	X		X
D2	BUS	CANL	NA			
D3	Power	GND	NA			
E1	Ch2	O	FH2 max 10A		X	X
E2	BUS	CANH	NA			
E3	Ch7	O	FH7 max 10A			X
F1	Ch3	O	FH3 max 10A			X
F2	Ch11	O	FH11 max 10A			X
F3	Ch8	O	FH8 max 10A			X

Function Summary

- **O**: Output relay NO
- **TXRX+**, **TXRX-**: RS485 bus signals
- **GND**: Internally connected to Negative terminal of the batteries
- **CAN-L**, **CAN-H**: CAN bus signals

7. Output State Machine Diagram

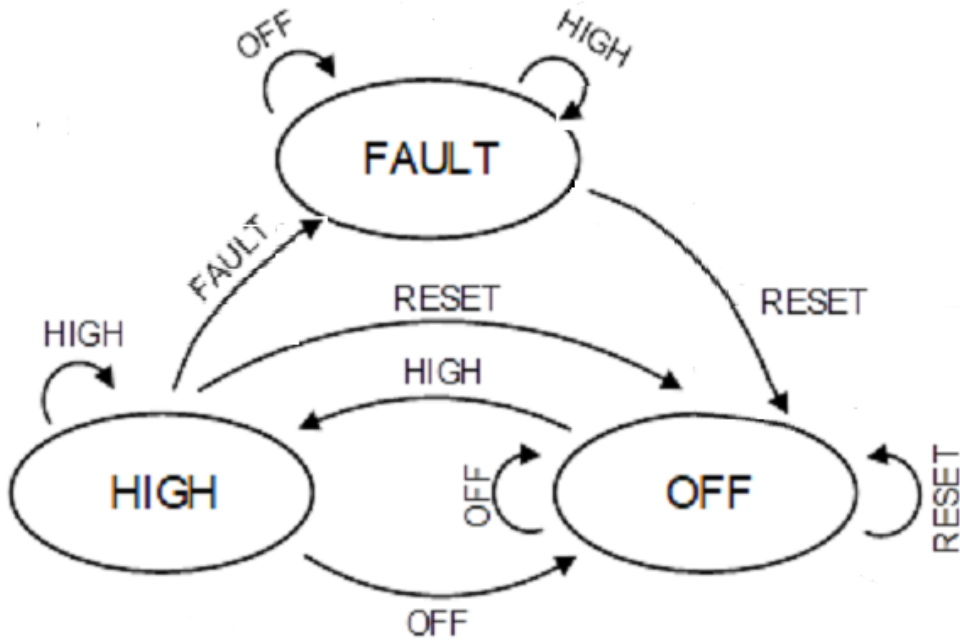

The output pin can be set to one of the 3 available states:

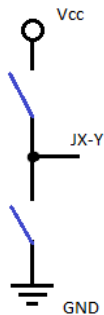
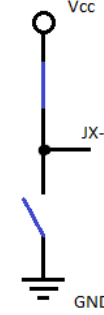
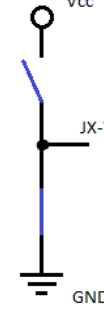
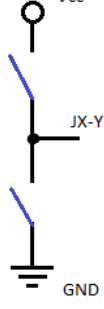
Output state	Pin voltage	Equivalent Circuit
OFF	Floating	
HIGH	High Side - Battery Voltage	
	Low Side - GND	
FAULT	Floating	

Each output circuit is protected against short circuits and overcurrent by a fuse. A failure event occurs when the output command is HIGH (High Side) but the fuse is blown and the voltage level of the pin is not at the battery voltage. If the output command is Low Side the fault state is not detected. To recover the pin from the FAULT state, a reset command is needed. The reset command returns the pin to its initial OFF state.

8. CANopen Messages Structure

All the data type used are unsigned integer and the syntax is specified in the following table:

octet number	1.	2.	3.	4.	5.	6.	7.	8.
UNSIGNED8	b7..b0							
UNSIGNED16	b7..b0	b15..b8						
UNSIGNED24	b7..b0	b15..b8	b23..b16					
UNSIGNED32	b7..b0	b15..b8	b23..b16	b31..b24				
UNSIGNED40	b7..b0	b15..b8	b23..b16	b31..b24	b39..b32			
UNSIGNED48	b7..b0	b15..b8	b23..b16	b31..b24	b39..b32	b47..b40		
UNSIGNED56	b7..b0	b15..b8	b23..b16	b31..b24	b39..b32	b47..b40	b55..b48	
UNSIGNED64	b7..b0	b15..b8	b23..b16	b31..b24	b39..b32	b47..b40	b55..b48	b63..b56

NMT MESSAGES

The Network Management messages follow a master-slave structure. Through NMT services, CANopen devices are initialized, started, reset, or stopped. All CANopen devices are regarded as NMT slaves. NMT messages have CAN-ID always equal to 00h.

00h	1-byte command specifier	1-byte NODE-ID	6 bytes not used
------------	--------------------------	----------------	------------------

PDO MESSAGES

PDO are fast telegram messages that can simply manage the most important functions. All PDOs have an equivalent SDO message. There are no answers for this type of messages. PDO messages have identifiers from 180h to 57Fh.

Identifier	8-byte data
-------------------	-------------

SDO MESSAGES

SDO are more complex messages that completely manage all the functions of the Keybox. SDO messages have identifiers from 580h to 67Fh and always expect an answer or an acknowledge reply.

Identifier	Command byte	2-byte index	1-byte sub index	4-byte data
-------------------	--------------	--------------	------------------	-------------

Identifier: The messages to the Keybox shall have 600h+current CAN ID identifier.

The messages from the Keybox have 580h+ current CAN ID identifier.

Command byte:

40h: request to read a register	60h: write acknowledge
43h: response with 4-byte data	23h: request to write 4-byte data
4Fh: response with 1-byte data	2Fh: request to write 1-byte data
4Bh: response with 2-byte data	2Bh: request to write 2-byte data
80h: error response	

Every answer has index and sub index echo.

The error responses have the byte data containing the abort codes.

Abort codes implemented:

0602 0000h: Object does not exist in the object dictionary
0609 0011h: Sub-index does not exist
0609 0030h: Invalid value for parameter
0601 0002h: Attempt to write a read only object

9. CAN Messages for Managing Output Pins

Output state	Direction	Can message
HIGH	Write	PDO 200 + node-ID
	Read/Write	SDO Object 2001h
	Read/Write	SDO Object 2008h sub-index 02h
OFF	Write	PDO 200h + node-ID
	Read/Write	SDO Object 2001h
	Read/Write	SDO Object 2008h sub-index 01h
FAULT	Read when occur	PDO 180h + node-ID
	Read	SDO Object 2001h
	Read	SDO Object 2008h sub-index 06h
RESET	Write	SDO Object 2001h
PWM	Write	SDO Object 2009h sub-index 01h

10. CAN bus Default Settings

Setting	Default Status or Level	How to Change
Baud rate	125 kbit/s	Object 2010h
CANopen Node ID	0Ch	Object 2011h
CANopen Node State	Pre-operational	NMT Message Start CANopen node Object 2013h Device active on startup
Periodic Message Transmission	Disable	Object 2012h
Heartbeat Message	Disable	Object 1017h
Boot-up service	Active	Object 2015h
Restore default parameters	-	Object 1011h

NMT MESSAGES

The Network Management Messages follow a master-slave structure. Through NMT services, CANopen devices are initialized, started, reset, or stopped. All CANopen devices are regarded as NMT slaves.

NMT messages have CAN-ID always equal to 00h.

11. Start CANopen Node

Identifier	00h	
Byte 0	01h	Start CANopen node
Byte 1	XXh	Keybox CAN ID 00h: start all the devices 0Ch: start the Keybox with CAN ID = 0Ch.
Byte 2, 7	00h	Not used

Example:

Direction	Identifier	Format	Message
To Keybox	0	Std	01 0C

12. Enter Pre-operational

Identifier	00h	
Byte 0	80h	Enter pre-operational
Byte 1	XXh	Keybox CAN ID 00h: start all the devices 15h: start the Keybox with CAN ID = 0Ch.
Byte 2, 7	00h	Not used

Example:

Direction	Identifier	Format	Message
To Keybox	0	Std	80 0C

13. Reset CANopen Node

Identifier	00h	
Byte 0	81h	Reset CANopen node
Byte 1	XXh	Keybox CAN ID 00h: start all the devices 15h: start the Keybox with CAN ID = 0Ch.
Byte 2, 7	00h	Not used

Example:

Direction	Identifier	Format	Message
To Keybox	0	Std	81 0C

14. Stop CANopen Node

Identifier	00h	
Byte 0	XXh	02h: Stop CANopen node
Byte 1	YYh	Keybox CAN ID 00h: Stop all the devices 15h: Stop the Keybox with CAN ID = 0Ch.
Byte 2, 7	00h	Not used

Example:

Direction	Identifier	Format	Message
To Keybox	0	Std	02 0C

15. Boot-up Service

This service is used to signal that a NMT slave has entered the NMT Pre-operational state.

Identifier	700h + current CAN ID	Default 70Ch
Byte 0	00h	One data byte is transmitted with value 0.

Example:

Direction	Identifier	Format	Message
From Keybox	70Ch	Std	00h

The Keybox with CAN ID 0Ch has entered the NMT state Pre-operational.

16. Heartbeat Message

The heartbeat mechanism for a CANopen device is established by configuring the heartbeat producer to cyclically transmitting the heartbeat message. One or more CANopen devices in the network should be aware of this message. If by any chance the heartbeat producer fails to send the heartbeat message, the local application on the heartbeat consumer will be notified.

In the case the CANopen device starts with a heartbeat producer time different from 0, then the boot-up message is regarded as the first heartbeat message.

Identifier	700h + current CAN ID	Default 70Ch
Byte 0	XXh	XXh: State of heartbeat producer 00h: Boot-up 04h: Stopped 05h: Operational 7Fh: Pre-operational

Example:

Direction	Identifier	Format	Message	Data
From Keybox	70Ch	Std	00h	Boot up
From Keybox	70Ch	Std	7Fh	Pre-operational
To Keybox	00h	Std	01h 0Ch	Start Keybox with CAN id = 0Ch
From Keybox	70Ch	Std	05h	Operational

PDO Messages

17. Set Output (OFF and HIGH)

Identifier	200h + current CAN ID	Default 20Ch
Byte 0	P80 P70 P60 P50 P40 P30 P20 P10	'1' = set OFF '0' = do nothing
Byte 1	0 0 0 P130 P120 P110 P100 P90	'1' = set OFF '0' = do nothing
Byte 2	P8H P7H P6H P5H P4H P3H P2H P1H	'1' = set HIGH '0' = do nothing
Byte 3	0 0 0 P13H P12H P11H P10H P9H	'1' = set HIGH '0' = do nothing
Byte 4,7	00h	Not used

Examples:

Direction	Identifier	Format	Message	Data
To Keybox	20C	Std	81 00 00 00 00 00 00 00	Set PINs 8 and 1 OFF
To Keybox	20C	Std	00 00 00 03 00 00 00 00	Set PINs 9 and 10 HIGH
To Keybox	20C	Std	01 00 02 00 00 00 00 00	Set PIN 1 OFF and PIN 2 HIGH

If the same pin is set to more than one state, the priority is OFF and HIGH.

18. Fault Message

This message is sent by the Keybox when a blown fuse is detected.

Note: in the case a fuse is blown during the PWM mode (for the outputs 12 and 13 only), the device will not transmit the corresponding fault message (See [Object 2009h](#) for further details).

Identifier	180h + current CAN ID	Default 18Ch
Byte 0	P8 P7 P6 P5 P4 P3 P2 P1	'1' = fault '0' = not fault
Byte 1	0 0 0 P13 P12 P11 P10 P9	'1' = fault '0' = not fault
Byte 2,7	00h	Not used

Examples

Direction	Identifier	Format	Message	Data
From Keybox	18C	Std	18 00 00 00 00 00 00 00	PINs 4 and 5 fault state
From Keybox	18C	Std	00 01 00 00 00 00 00 00	PIN 9 fault state

SDO messages

19. Object 2001h: Single Pin State

This object sets and reads the state of each output pins.

Identifier	600h + current CAN ID	Default 60Ch
Byte 0	40h	Read Device Register
	2Fh	Write 1-byte data
Byte 1	01h	CAN Object 2001h
Byte 2	20h	
Byte 3	00h	Highest sub-index supported (read only)
	01h	P1
	02h	P2
	03h	P3
	04h	P4
	05h	P5
	06h	P6
	07h	P7
	08h	P8
	09h	P9
	0Ah	P10
	0Bh	P11
	0Ch	P12
	0Dh	P13
Byte 4	00h	OFF
	01h	HIGH
	02h	RESET
	03h	FAULT (read only)
Byte 5,7	00h	Not used

Examples:

Direction	Identifier	Format	Message	Data
To Keybox	60C	Std	40 01 20 00 00 00 00 00	Read highest sub-index supported
Keybox reply	58C	Std	4F 01 20 0D 00 00 00 00	0Dh is the highest sub-index
To Keybox	60C	Std	40 01 20 04 00 00 00 00	Read state PIN 4
Keybox reply	58C	Std	4F 01 20 04 01 00 00 00	PIN 4 HIGH
To Keybox	60C	Std	40 01 20 02 00 00 00 00	Read state PIN 2
Keybox reply	58C	Std	40 01 20 02 00 00 00 00	PIN 2 OFF
To Keybox	60C	Std	2F 01 20 05 02 00 00 00	RESET PIN 5
Keybox reply	58C	Std	60 01 20 05 00 00 00 00	ACK
To Keybox	60C	Std	2F 01 20 0A 01 00 00 00	Set PIN 10 to HIGH
Keybox reply	58C	Std	60 01 20 0A 00 00 00 00	ACK

20. Object 2003h: Read Digital Input

This object reads digital input values.

Identifier	600h + current CAN ID	Default 60Ch
Byte 0	40h	Read Device Register
Byte 1	03h	CAN Object 2003h
Byte 2	20h	
Byte 3	00h	Highest sub-index supported
	01h	Read input from PIN1 to PIN13
Byte 4,7	00h	Not used

Keybox reply:

Identifier	58Ch (580h + current CAN ID)	
Byte 0	4Bh	Response length 2-byte CAN Object 2003h
Byte 1	03h	
Byte 2	20h	

Byte 3	00h	sub-index
Byte 4	01h	Highest sub-index supported
Byte 5,7	00h	Not used

Byte 3	01h	sub-index
Byte 4	P8 P7 P6 P5 P4 P3 P2 P1	Digital input
Byte 5	0 0 0 P13 P12 P11 P10 P9	
Byte 6,7	00h	Not used

21. Object 2008h: Output State

This object sets and reads the state of each output pin.

Identifier	600h + current CAN ID	Default 60Ch
Byte 0	40h	Read Device Register
	2Bh	Write 2-bytes
Byte 1	08h	CAN Object 2008h
Byte 2	20h	
Byte 3	00h	Highest sub-index supported (read only)
	01h	Output OFF
	02h	Output HIGH
	03h	Output FAULT (read only)
Byte 4	P8 P7 P6 P5 P4 P3 P2 P1	Each bit sets a pin
Byte 5	0 0 0 P13 P12 P11 P10 P9	Each bit sets a pin
Byte 6,7	00h	Always '0'

Examples:

Direction	Identifier	Format	Message	Data
To Keybox	60C	Std	2B 08 20 02 08 00 00 00	Set PIN 4 HIGH
Keybox reply	58C	Std	60 08 20 02 00 00 00 00	ACK
To Keybox	60C	Std	40 08 20 01 00 00 00 00	Who is OFF?
Keybox reply	58C	Std	4B 08 20 01 00 00 00 00	No output OFF
To Keybox	60C	Std	40 08 20 02 00 00 00 00	Who is HIGH?
Keybox reply	58C	Std	4B 08 20 02 FF 00 00 00	PINs from 1 to 8 are HIGH

22. Object 2009h: PWM State {future upgrade¹}

This object enables the PWM on the outputs (PIN 12 and PIN 13) supporting this feature.
NOTE: the PWM state is applicable to a single pin or both with a signal whose frequency does not exceed 1 kHz.

NOTE 2: if a fault state occurs on the outputs 12 and/or 13 during the PWM mode, this event will not be transmitted by the corresponding fault message.

Identifier	600h + current CAN ID	Default 60Ch
Byte 0	40h	Read Device Register
	2Bh	Write 2-bytes
Byte 1	09h	CAN Object 2009h
Byte 2	20h	
Byte 3	00h	Highest sub-index supported (read only)
	01h	Output PWM
Byte 4	0 0 0 0 0 0 P13 P12	Each bit sets a pin
Byte 5	XXh	Duty cycle level [D] ² 00h-0Ah → 0%-100%
Byte 6,7	00h	Not used

Examples:

Direction	Identifier	Format	Message	Data
To Keybox	60C	Std	40 09 20 00 00 00 00 00	Read highest sub-index supported
Keybox reply	58C	Std	4F 09 20 00 01 00 00 00	01h is the highest sub-index
To Keybox	60C	Std	2B 09 20 01 01 01 00 00	Set PWM on PIN 12 with D=10%
Keybox reply	58C	Std	60 09 20 01 00 00 00 00	ACK
To Keybox	60C	Std	2B 09 20 01 02 05 00 00	Set PWM on PIN 13 with D=50%
Keybox reply	58C	Std	60 09 20 01 00 00 00 00	ACK
To Keybox	60C	Std	2B 09 20 01 03 08 00 00	Set PWM on PINs 12 and 13 with D=80%
Keybox reply	58C	Std	60 09 20 01 00 00 00 00	ACK
To Keybox	60C	Std	40 09 20 01 00 00 00 00	Who is PWM?
Keybox reply	58C	Std	4B 09 20 01 03 08 00 00	PINs 12 and 13 in PWM state with D=80%

¹ NOTE: The description of this object is for illustrative purposes only. The message structure may change in compliance with the software development.

² With this parameter it is possible to adjust the power supplied to the outputs from 0% to 100% with variations of 10% per level as shown in the table below:

Level	Duty cycle [%]	Value [h]
0	0 (OFF)	00
1	10	01
2	20	02
3	30	03
4	40	04
5	50	05
6	60	06
7	70	07
8	80	08
9	90	09
10	100 (ON)	0A

23. Object 2010h: Baud rate settings

This object sets and reads the baud rate.

Identifier	600h + current CAN ID	Default 60Ch
Byte 0	40h	Read Device Register
	2Fh	Write 1-byte data
Byte 1	10h	CAN Object 2010h
Byte 2	20h	
Byte 3	00h	Sub index
Byte 4	XXh	XXh: 00h: 125k (default) 01h: 250k 02h: 500k
Byte 5,7	00h	Not used

Examples:

Direction	Identifier	Format	Message	Data
To Keybox	60C	Std	40 10 20 00 00 00 00 00 00	Read baud rate
Keybox reply	58C	Std	4F 10 20 00 01 00 00 00 00	01h = 250k
To Keybox	60C	Std	2F 10 20 00 02 00 00 00 00	Set 02h = 500k
Keybox reply	58C	Std	60 10 20 00 00 00 00 00 00	ACK
To Keybox	60C	Std	2F 10 20 00 00 00 00 00 00	Set 00h = 125k
Keybox reply	58C	Std	60 10 20 00 00 00 00 00 00	ACK

24. Object 2011h: Set node ID

This object sets and reads the CANopen node-id.

Identifier	600h + current CAN ID	Default 60Ch
Byte 0	40h	Read Device Register
	2Fh	Write 1-byte data
Byte 1	11h	CAN Object 2011h
Byte 2	20h	
Byte 3	00h	Sub index
Byte 4	XXh	New node id: (01h - 7Fh)
Byte 5,7	00h	Not used

Examples:

Direction	Identifier	Format	Message	Data
To Keybox	60C	Std	40 11 20 00 00 00 00 00	Read Node ID
Keybox reply	58C	Std	4F 11 20 00 15 00 00 00	ID = 15h
To Keybox	60C	Std	2F 11 20 00 16 00 00 00	Set ID = 16h
Keybox reply	58C	Std	60 11 20 00 00 00 00 00	ACK

25. Object 2012h: Set Periodic Messages

This object sets the periodic transmission of TPDO 180h (Fault Message).

Identifier	600h + current CAN ID	Default 60Ch
Byte 0	40h	Read Device Register
	2Bh	Write 2-byte data
Byte 1	12h	CAN Object 2012h
Byte 2	20h	
Byte 3	00h	Sub index
Byte 4	YYh	YYh: Periodic transmission timer in milliseconds LSByte
Byte 5	XXh	XXh: Periodic transmission timer in milliseconds MSByte
Byte 6,7	00h	Not used

Periodic transmission timer: XXYYh (from 0001h to FEFFh: from 1 to 65279 milliseconds).

Examples:

Direction	Identifier	Format	Message	Data
To Keybox	60C	Std	40 12 20 00 00 00 00 00	Read register
Keybox reply	58C	Std	4B 12 20 00 0A 00 00 00	Period = 100ms
To Keybox	60C	Std	2B 12 20 00 32 00 00 00	Set period = 500ms
Keybox reply	58C	Std	60 12 20 00 00 00 00 00	ACK

26. Object 2013h: Set Device Active on Startup

If device is active on startup don't need start command from master.

Identifier	600h + current CAN ID	Default 60Ch
Byte 0	40h	Read Device Register
	2Fh	Write 1-byte data
Byte 1	13h	CAN Object 2013h
Byte 2	20h	
Byte 3	00h	Sub index
Byte 4	XXh	00h: NOT ACTIVE 01h: ACTIVE
Byte 5,7	00h	Not used

Examples:

Direction	Identifier	Format	Message	Data
To Keybox	60C	Std	40 13 20 00 00 00 00 00	Read register
Keybox reply	58C	Std	4F 13 20 00 00 00 00 00	Not active at start
To Keybox	60C	Std	2F 13 20 00 01 00 00 00	Set active on start
Keybox reply	58C	Std	60 13 20 00 00 00 00 00	ACK

27. Object 2015h: Set Boot-up Service

This object enables and disables the boot-up message.

Identifier	600h + current CAN ID	Default 60Ch
Byte 0	40h	Read Device Register
	2Fh	Write 1-byte data
Byte 1	15h	CAN Object 2015h
Byte 2	20h	
Byte 3	00h	Sub index
Byte 4	XXh	00h: NOT ACTIVE 01h: ACTIVE
Byte 5,7	00h	Not used

Examples:

Direction	Identifier	Format	Message	Data
To Keybox	60C	Std	40 15 20 00 00 00 00 00	Read register
Keybox reply	58C	Std	4F 15 20 00 00 00 00 00	Not active at start
To Keybox	60C	Std	2F 15 20 00 01 00 00 00	Set active on start
Keybox reply	58C	Std	60 15 20 00 00 00 00 00	ACK

28.Object 1016h: Consumer Heartbeat Time

The consumer heartbeat time object shall indicate the expected heartbeat cycle times. Monitoring of the heartbeat producer shall start after the reception of the first heartbeat.

NOTE 1: the heartbeat consumer time should be greater (typically twice) than the related heartbeat time to be monitored coming from the producer.

NOTE 2: if the keybox does not receive the heartbeat message producer anymore, it turns off all the outputs and goes into pre-operational state until a new NMT start message is received, even if the producer restarts to transmit the heartbeat.

NOTE 3: if the consumer heartbeat time is set with a value lower than the producer one, the keybox will not be able to change its state from pre-operational to operational.

Identifier	600h + current CAN ID	Default 60Ch
Byte 0	40h	Read Device Register
	23h	Set device register
Byte 1	16h	CAN Object 1016h
Byte 2	10h	
Byte 3	ZZh	
Byte 4	YYh	YYh: Heartbeat time in milliseconds LSBByte
Byte 5	XXh	XXh: Heartbeat time in milliseconds MSByte
Byte 6	NNh	Node to be monitored 01h-7Fh (01h default)
Byte 7	00h	Reserved

Heartbeat time: XYYYh (from 000Ah to FFFFh: from 10 to 65279 milliseconds)

When the period is set to 0000h, the consumer heartbeat function is disabled.

Examples:

Direction	Identifier	Format	Message	Data
To Keybox	60C	Std	40 16 10 00 00 00 00 00	Read highest sub-index supported
Keybox reply	58C	Std	4F 16 10 00 01 00 00 00	01h is the highest sub-index supported
To Keybox	60C	Std	23 16 10 01 64 00 7E 00	Set heartbeat time consumer = 100ms expected from the node 7Eh
Keybox reply	58C	Std	60 16 10 01 00 00 00 00	
To Keybox	60C	Std	23 16 10 01 F4 01 01 00	Set heartbeat time consumer= 500ms expected from the node 01h
Keybox reply	58C	Std	60 16 10 01 00 00 00 00	
To Keybox	60C	Std	40 16 10 01 00 00 00 00	Read heartbeat consumer time expected from the node 01h
Keybox reply	58C	Std	43 16 10 01 F4 01 01 00	Heartbeat consumer time set to 500ms

29. Object 1017h: Producer Heartbeat Time

The producer heartbeat time shall indicate the configured cycle time of the heartbeat.

Identifier	600h + current CAN ID	Default 60Ch
Byte 0	40h	Read Device Register
	2Bh	Set device register
Byte 1	17h	CAN Object 1017h
Byte 2	10h	
Byte 3	00h	Sub index
Byte 4	YYh	YYh: Heartbeat time in milliseconds
Byte 5	XXh	XXh: Heartbeat time in milliseconds
Byte 6, 7	00h	Not used

Heartbeat time: XXYYh (from 0001h to FFFFh: 1ms to 65279 milliseconds)

Examples:

Direction	Identifier	Format	Message	Data
To Keybox	60C	Std	40 17 10 00 00 00 00 00	Read heartbeat time
Keybox reply	58C	Std	4B 17 10 00 64 00 00 00	Heartbeat time = 100ms
To Keybox	60C	Std	2B 17 10 00 00 00 00 00	Switch off the heartbeat
Keybox reply	58C	Std	60 17 10 00 00 00 00 00	
To Keybox	60C	Std	2B 17 10 00 32 00 00 00	Heartbeat time = 50ms
Keybox reply	58C	Std	60 17 10 00 00 00 00 00	
To Keybox	60C	Std	2B 17 10 00 F4 01 00 00	Heartbeat time = 500ms
Keybox reply	58C	Std	60 17 10 00 00 00 00 00	

30. Object 1000h: Device Type

Identifier	600h + current CAN ID	Default 60Ch
Byte 0	40h	Read Device Register
Byte 1	00h	CAN Object 1000h
Byte 2	10h	
Byte 3	00h	Sub Index
Byte 4, 7	00h	Not used

Example:

Direction	Identifier	Format	Message
To Keybox	60C	Std	40 00 10 00 00 00 00 00
Keybox reply	58C	Std	43 00 10 00 91 01 03 00

Device profile number: 30191h generic I/O module.

I/O Functionality: digital I/O.

Mapping PDOs: Device specific PDO supported.

31. Object 1001h: Error Register

This object is not yet implemented in the device.

32. Object 1008h: Manufacturer Device Name

Identifier	600h + current CAN ID	Default 60Ch
Byte 0	40h	Read Device Register
Byte 1	08h	CAN Object 1008h
Byte 2	10h	
Byte 3, 7	00h	Not used

1° additional byte

Identifier	600h + current CAN ID	Default 60Ch
Byte 0	60h	Read Device Register Next Byte
Byte 1, 7	00h	Not used

2° additional byte

Identifier	600h + current CAN ID	Default 60Ch
Byte 0	70h	Read Device Register Next Byte
Byte 1, 7	00h	Not used

Example:

Direction	Identifier	Format	Message	Data
To Keybox	60C	Std	40 08 10 00 00 00 00 00	
Keybox reply	58C	Std	41 08 10 00 0B 00 00 00	
To Keybox	60C	Std	60 00 00 00 00 00 00 00	
Keybox reply	58C	Std	00 42 6C 69 6E 6B 4D 61	BlinkMa
To Keybox	60C	Std	70 00 00 00 00 00 00 00	
Keybox reply	58C	Std	17 72 69 6E 65 00 00 00	rine

Manufacturer Device Name: BlinkMarine

The first byte of the last data message replied is 17h.

33. Object 1009h: Manufacturer Hardware Revision

Identifier	600h + current CAN ID	Default 60Ch
Byte 0	40h	Read Device Register
Byte 1	09h	CAN Object 1009h
Byte 2	10h	
Byte 3, 7	00h	Not used

Example:

Direction	Identifier	Format	Message	Data
To Keybox	60C	Std	40 09 10 00 00 00 00 00	
Keybox reply	58C	Std	43 09 10 00 56 5F 30 32	V_02

Manufacturer Hardware Revision: V_02

34. Object 100Ah: Manufacturer Firmware Revision

Identifier	600h + current CAN ID	Default 60Ch
Byte 0	40h	Read Device Register
Byte 1	0Ah	CAN Object 100Ah
Byte 2	10h	
Byte 3, 7	00h	Not used

Example:

Direction	Identifier	Format	Message	Data
To Keybox	60C	Std	40 0A 10 00 00 00 00 00	
Keybox reply	58C	Std	43 0A 10 00 31 2E 30 30	1.00

Manufacturer Firmware Revision: 1.00

35. Object 100Bh: Model ID

Identifier	600h + current CAN ID	Default 60Ch
Byte 0	40h	Read Device Register
Byte 1	0Bh	CAN Object 100Bh
Byte 2	10h	
Byte 3, 7	00h	Not used

1° additional byte

Identifier	600h + current CAN ID	Default 60Ch
Byte 0	60h	Read Device Register second byte
Byte 1, 7	00h	Not used

Example:

Direction	Identifier	Format	Message	Data
To Keybox	60C	Std	40 0B 10 00 00 00 00 00	
Keybox reply	58C	Std	41 0B 10 00 07 00 00 00	
To Keybox	60C	Std	60 00 00 00 00 00 00 00	
Keybox reply	58C	Std	01 4B 65 79 62 6F 78 33	Keybox3

Model ID: Keybox3

The first byte of the last data message replied is 01h.

36. Object 1011h: Restore default parameters

With this object the default values of parameters according to the communication profile, device profile, and application profile are restored. This procedure shall only be executed when the specific signature "load" is written to the sub-index 01h. When the message shown in the following table is transmitted, the default values shall be restored after the keypad is reset.

Identifier	600h + current CAN ID	Default 60C
Byte 0	40h	Read Device Register
	23h	Set Device Register
Byte 1	11h	CAN Object 1011h
Byte 2	10h	
Byte 3	00h	Highest sub-index supported
	01h	Restore all parameters
Byte 4	6Ch	Character 1 "l"
Byte 5	6Fh	Character 2 "o"
Byte 6	61h	Character 3 "a"
Byte 7	64h	Character 4 "d"

Examples:

Direction	Identifier	Format	Message	Data
To Keybox	60C	Std	40 11 10 00 00 00 00 00	Read highest sub-index
Keybox reply	58C	Std	4F 11 10 00 01 00 00 00	1
To Keybox	60C	Std	23 11 10 01 6C 6F 61 64	'load'
Keybox reply	58C	Std	43 11 10 01 00 00 00 00	

37. Object 1018h: Identity object

Identifier	600h + current CAN ID	Default 60Ch
Byte 0	40h	Read Device Register
Byte 1	18h	CAN Object 1018h
Byte 2	10h	
Byte 3	XXh	00h: Highest sub-index supported
		01h: Vendor ID
Byte 4,7	00h	Not used

Example:

Direction	Identifier	Format	Message	Data
To Keybox	60C	Std	40 18 10 00 00 00 00 00	
Keybox reply	58C	Std	4F 18 10 00 01 00 00 00	01h
To Keybox	60C	Std	40 18 10 01 00 00 00 00	
Keybox reply	58C	Std	43 18 10 01 E2 03 00 00	000003E2h

Highest sub-index supported: 01h;
BlinkMarine Vendor ID: 000003E2h.

38. Object 1400h: Receive PDO 0 Communication Parameter

Describes the RPDO 0 parameters for setting the output PDO message.

Identifier	600h + current CAN ID	Default 60Ch	
Byte 0	40h	Read Device Register	
Byte 1	00h	CAN Object 1400h	
Byte 2	14h		
Byte 3	00h		Highest sub-index supported
		01h	COB-ID used by RPDO
		02h	Transmission type
Byte 4,7	00h	Not used	

Examples:

Direction	Identifier	Format	Message	Data
To Keybox	60C	Std	40 00 14 00 00 00 0 0 00	Read highest sub-index supported
Keybox reply	58C	Std	4F 00 14 00 02 00 00 00	02h
To Keybox	60C	Std	40 00 14 01 00 00 00 00	
Keybox reply	58C	Std	43 00 14 01 0C 02 00 00	0000 020Ch
To Keybox	60C	Std	40 00 14 02 00 00 00 00	
Keybox reply	58C	Std	4F 00 14 02 FE 00 00 00	FEh

Highest sub-index supported: 02h;

COB-ID used by RPDO: 0000 020Ch = 0000 0200h + Node-ID;

Transmission type: event-driven (manufacturer-specific).

39. Object 1600h: Receive PDO 0 Mapping Parameter

Describes the RPDO 0 mapping parameters for setting the output PDO message.

Identifier	600h + current CAN ID	Default 60Ch
Byte 0	40h	Read Device Register
Byte 1	00h	CAN Object 1600h
Byte 2	16h	
Byte 3	XXh	
Byte 4,7	00h	Not used

Example:

Direction	Identifier	Format	Message	Data
To Keybox	60C	Std	40 00 16 00 00 00 00 00	Read number of mapped objects
Keybox reply	58C	Std	4F 00 16 00 02 00 00 00	02
To Keybox	60C	Std	40 00 16 01 00 00 00 00	
Keybox reply	58C	Std	43 00 16 01 10 01 08 20	2008 01 10
To Keybox	60C	Std	40 00 16 02 00 00 00 00	
Keybox reply	58C	Std	43 00 16 02 10 02 08 20	2008 02 10

Number of mapped objects: 03h;

PDO Mapping ENTRY 1: set output pin OFF: index 2008h, sub-index 01h, length 10h;

PDO Mapping ENTRY 2: set output pin HIGH: index 2008h, sub-index 02h, length 10h.

40. Object 1800h: Transmit PDO 0 Communication Parameter

Describes the TPDO communication parameters for output FAULT state.

Identifier	600h + current CAN ID	Default 60Ch
Byte 0	40h	Read Device Register
Byte 1	00h	CAN Object 1800h
Byte 2	18h	
Byte 3	00h	
	01h	COB-ID used by TPDO
	02h	Transmission type
Byte 4,7	00h	Not used

Examples:

Direction	Identifier	Format	Message	Data
To Keybox	60C	Std	40 00 18 00 00 00 00 00	Read highest sub-index supported
Keybox reply	58C	Std	4F 00 18 00 02 00 00 00	02h
To Keybox	60C	Std	40 00 18 01 00 00 00 00	
Keybox reply	58C	Std	43 00 18 01 8C 01 00 00	0000 018Ch
To Keybox	60C	Std	40 00 18 02 00 00 00 00	
Keybox reply	58C	Std	4F 00 18 02 FE 00 00 00	FEh

Highest sub-index supported: 02h;

COB-ID used by TPDO: 0000 018Ch; 0000 0180h + Node-ID;

Transmission type: event-driven (manufacturer-specific).

41. Object 1A00h: Transmit PDO 0 Mapping Parameter

Describes the TPDO 0 communication parameters for reading output FAULT states.

Identifier	600h + current CAN ID	Default 60Ch
Byte 0	40h	Read Device Register
Byte 1	00h	CAN Object 1A00h
Byte 2	1Ah	
Byte 3	00h	Number of mapped objects
	01h	1 st application object
Byte 4,7	00h	Not used

Examples:

Direction	Identifier	Format	Message	Data
To Keybox	60C	Std	40 00 1A 00 00 00 00 00	Read number of mapped objects
Keybox reply	58C	Std	4F 00 1A 00 01 00 00 00	01
To Keybox	60C	Std	40 00 1A 01 00 00 00 00	
Keybox reply	58C	Std	43 00 1A 01 10 03 08 20	2008 03 10

Number of mapped objects: 1;

Application object: Read output FAULT state;
Index 2008h; sub-index 03h; length 10h.

42. Revision history

Date	Manual Revision	Comment	Related SW version
18/04/2019	1.0	First release	x.x

DRAFT