

WEEKEND WARRIOR

INSTALLATION MANUAL

HYBRID



GRIDFREE

WEEKEND WARRIOR - HYBRID



Only steps 1 - 11 in this kit are under the 120V DC standards for extra-low voltage (ELV). ELV is an electricity supply voltage in a range which carries a very low risk of electrical shock. Steps 12 and 13 are 240V AC and will require an electrician.



Installation of this kit will require an electrician when working with 240V, to wire the hybrid inverter into the mains or a generator. You cannot legally DIY these steps.

We are always happy to help guide you through the install, troubleshoot, and answer any questions. You can contact us on 09 218 5533, or info@gridfree.store.

We recommend reading these instructions in full prior to starting your install.

KIT CONTENTS

25mm² Cable 3m Pre-Crimped (Red+Black)



6mm² Solar PV Cable pair 10m - MC4 (Female, Red + Male, Black)



50mm² Battery Link Cable 20cm (Blue)



2x Z-Bracket Solar Mount

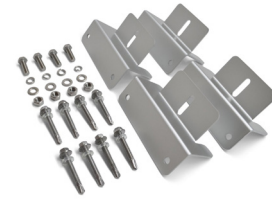



The "C" label is the same as the Amp "A" label of the breaker.

15A DC Circuit Breaker



125A MCCB



Growatt 2KW Hybrid Inverter



2x 12v200Ah Deep Cycle Gel Battery



2x PERC MONO Solar Panel



REQUIRED TOOLS

Drill



Screw Drivers

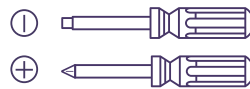

6mm Allen Key



Wire Strippers

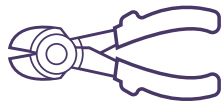

13mm Spanner



Socket Set



WIRING OVERVIEW

- ① 125A Breaker
- ② 15A Breaker - C15
- ③ Generator / Mains Input
- ④ Mains Distribution Box

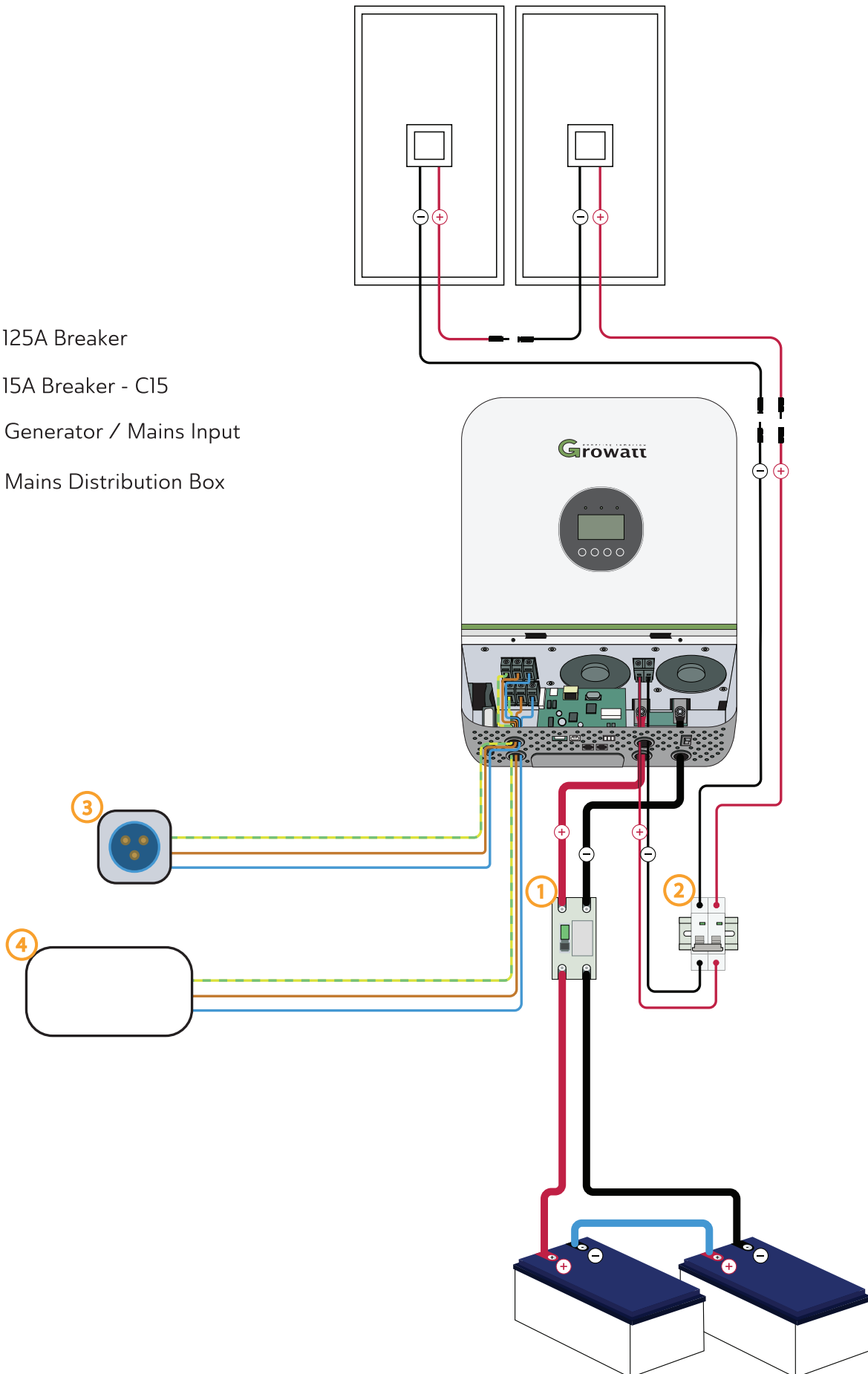

SOLAR PANEL WIRING

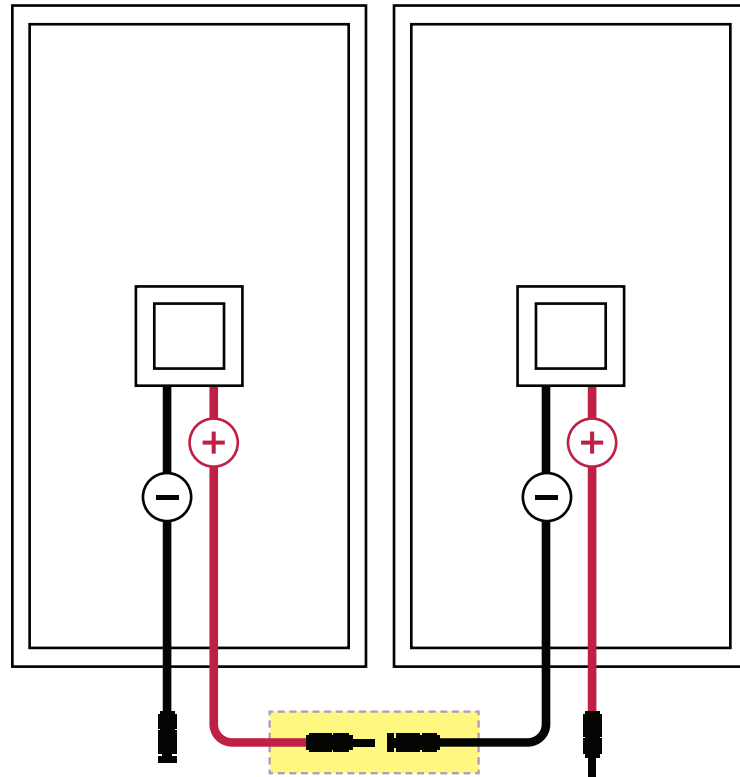

-
- 1 Wire the panels together by connecting the positive terminal of one panel, to the negative terminal of another. This creates two solar array outputs, one positive, one negative.
-

SOLAR PANEL WIRING

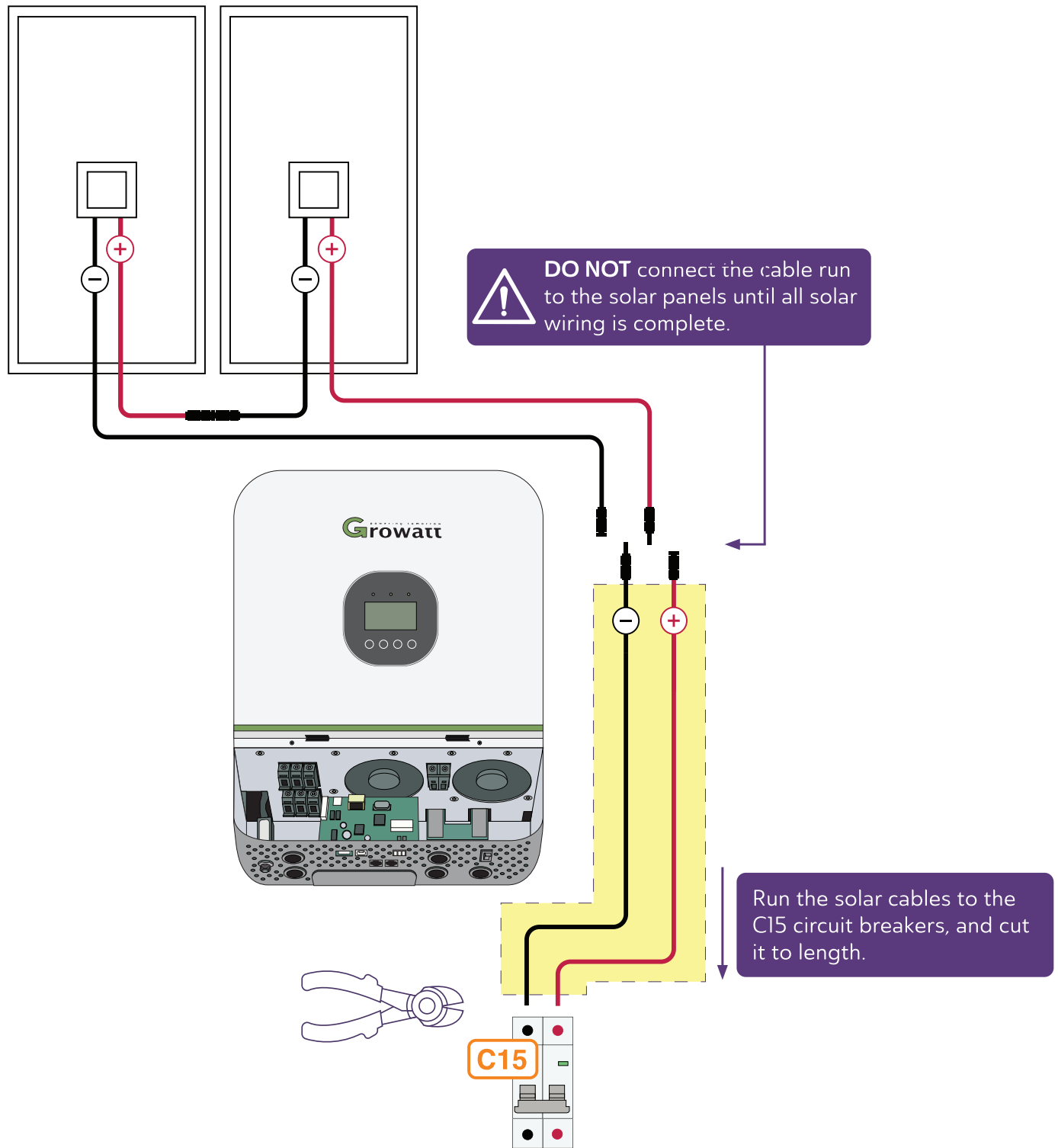

- 2 Run the 6mm solar cables from the solar panels back to the C15 circuit breakers, and cut it to length.



DO NOT connect the cable run to the solar panels yet, as the cables will become live. Wait until all solar wiring is complete.

Note: We recommend the PV cable to be run inside of a conduit when the cable is run across a roof, floor, or the interior of a building.

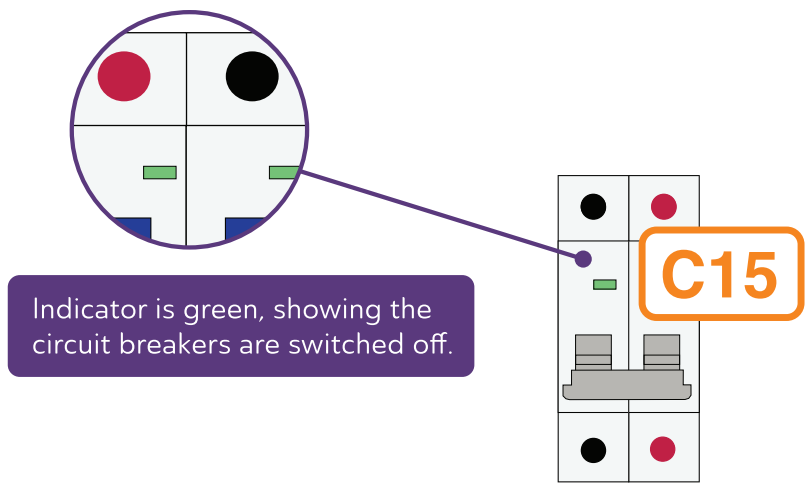

⚠ Ensure the solar cable run is **NOT** connected to the solar panels, and the circuit breakers are switched off (showing green, switch down).

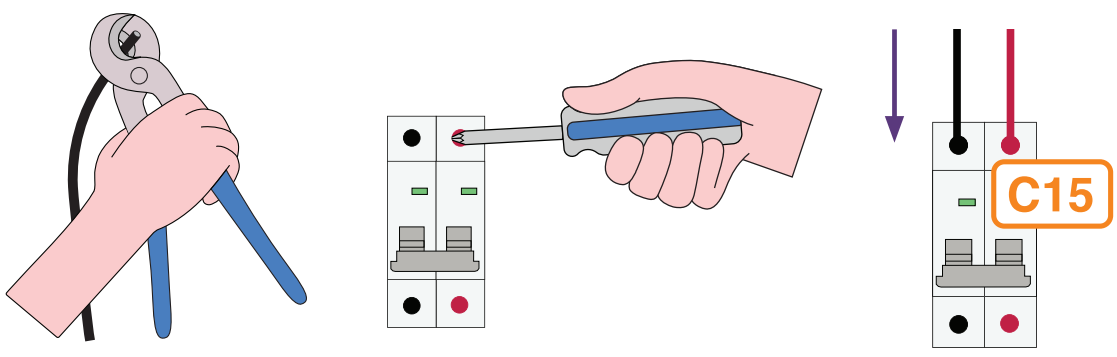

- 3 Use wire strippers to strip the ends of the solar cable, and terminate them in the circuit breaker by inserting the stripped end and tightening the screw clockwise. Make sure the clamp inside the circuit breaker is contacting the metal conductor, and **NOT** the insulation of the wire.

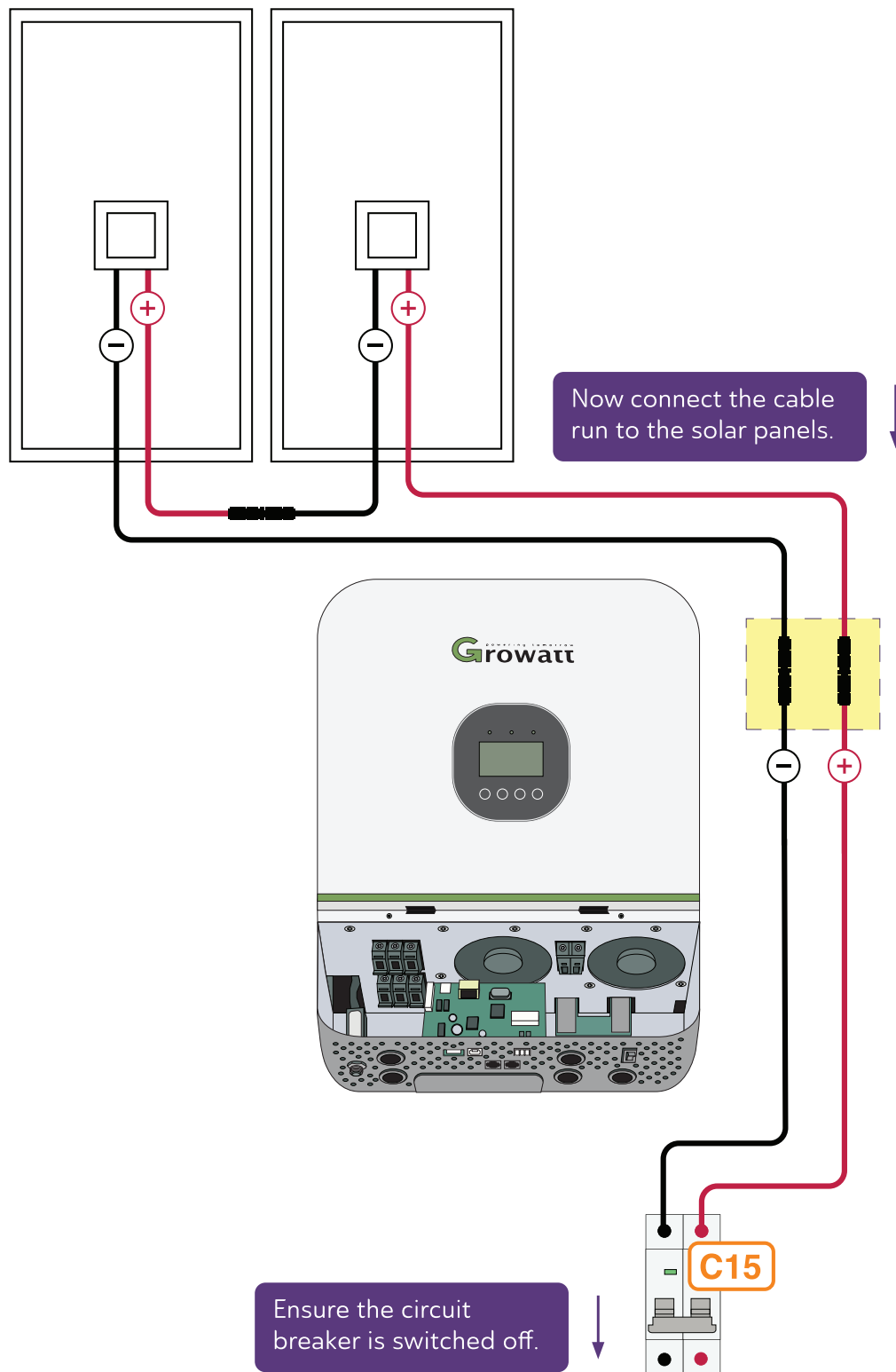

- 4 When the cables have been terminated in the circuit breaker, and the circuit breaker is switched off, you can now connect the solar panels to the cable run. The circuit breaker must be switched off when connecting or disconnecting the solar panels from the cable run.

For your safety do not connect or disconnect any solar cables when there is current running through them.

CHARGE CONTROLLER & INVERTER WIRING

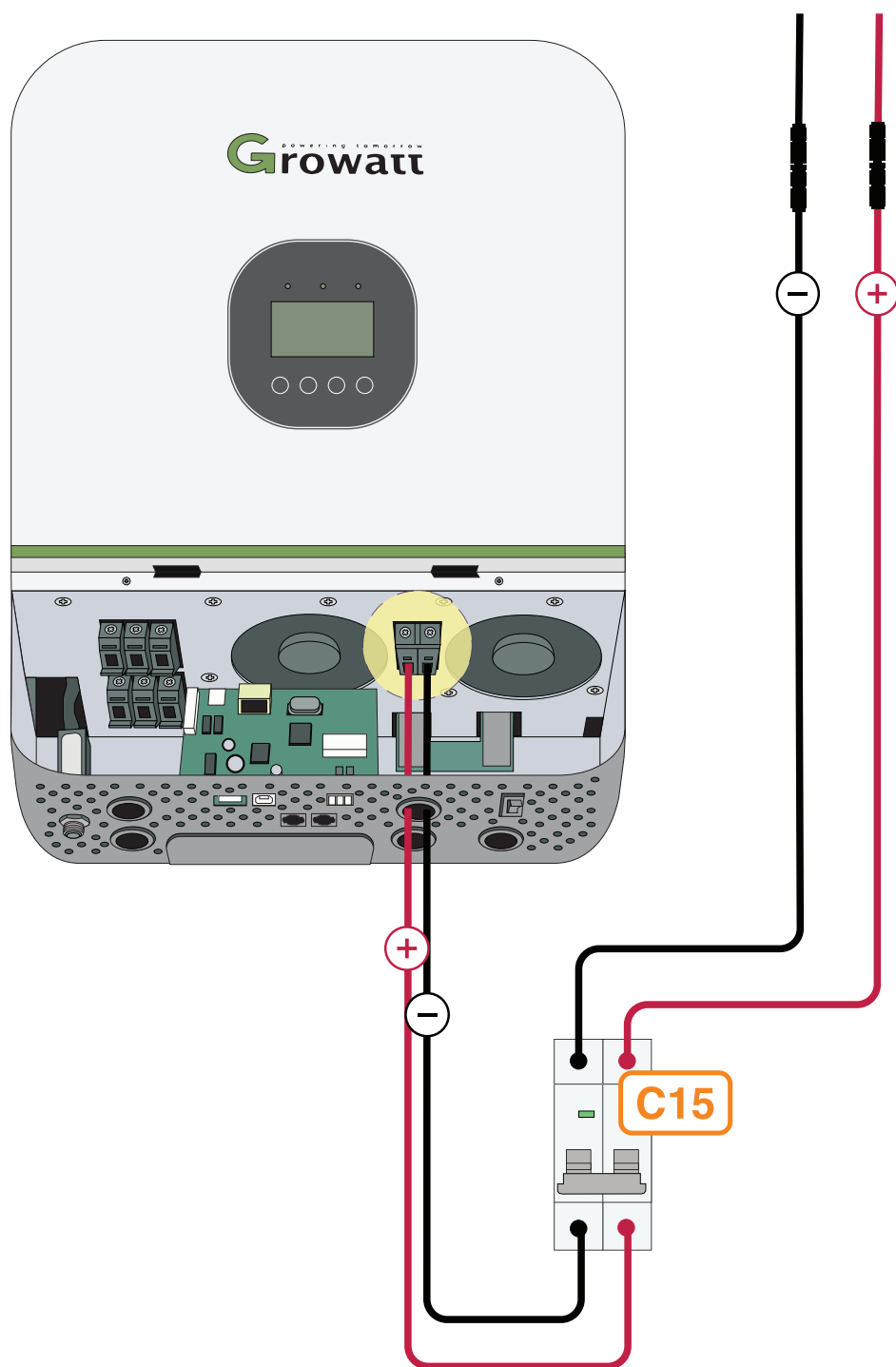

-
- 5 Run the positive and negative cables from the C15 circuit breaker to the hybrid inverter.
-

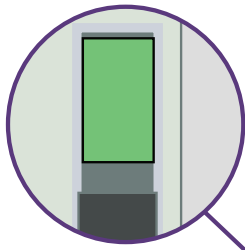

Ensure breakers are switched off, in the down position, showing a green indicator.

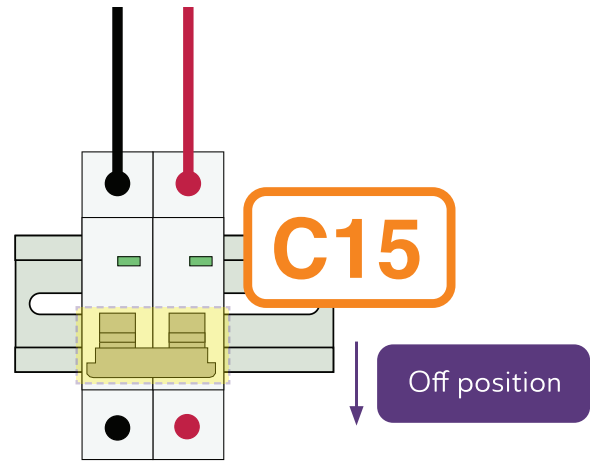
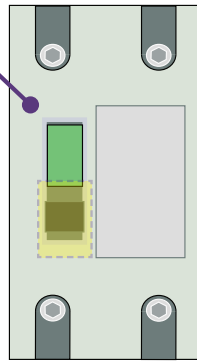

- 6 Ensure all circuit breakers are switched off (switch in the down position, indicator showing green) before wiring.

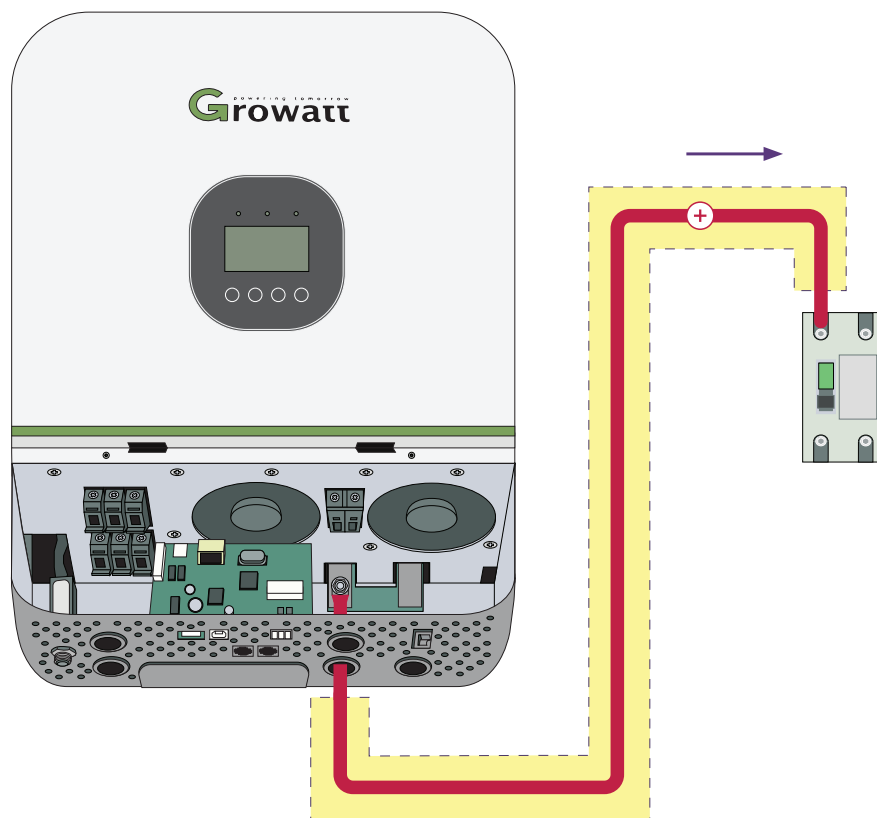

7 Wire the positive (+) 25mm cable from the hybrid inverter to the 125A MCCB circuit breaker.

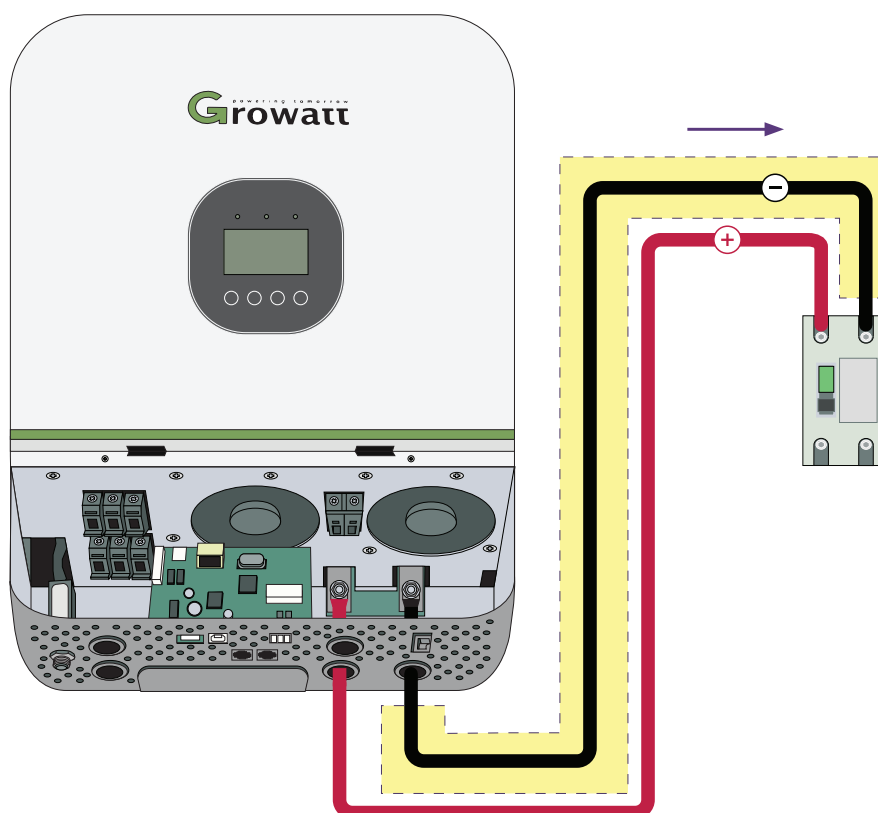

8 Wire the negative (-) 25mm cable from the hybrid inverter to the 125A MCCB circuit breaker.

BATTERY BANK SETUP AND WIRING

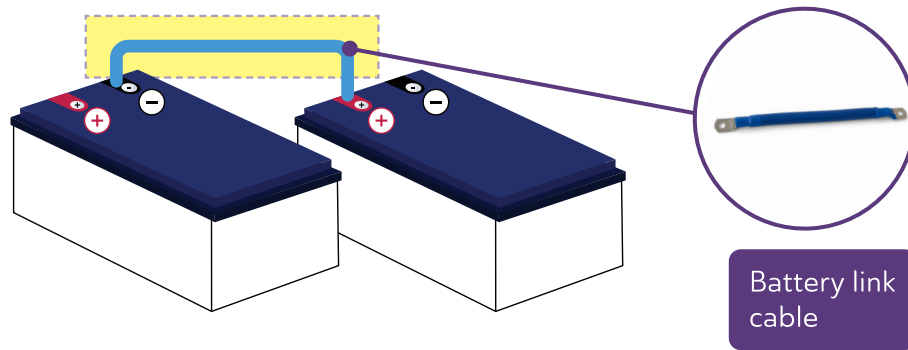

- 9 The battery bank is wired with two 12V batteries in series, this creates a 24V battery bank. The large gauge cable is used to connect the batteries together and used to connect to the hybrid inverter.

Wire the two batteries together from negative to positive with the blue battery link cable.



When wiring the blue cable ensure that you fully attach each cable at both ends before moving onto the next.

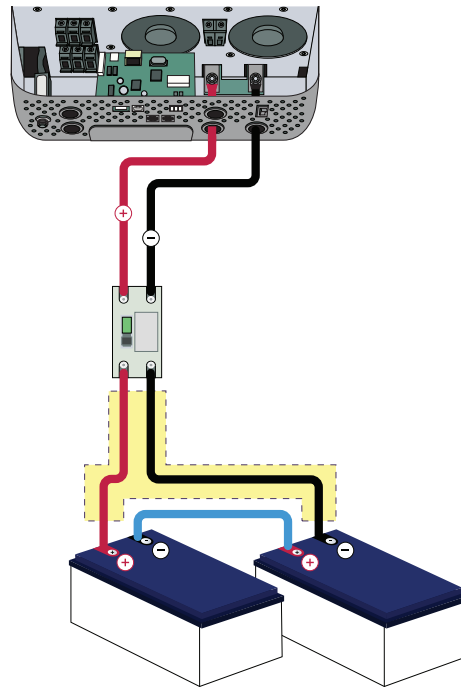

- 10 Wire the remaining set of red and black 25mm cable to the hybrid inverter through the C125 circuit breaker.



When running the wires from the battery bank to the circuit breaker, be very careful not to touch the positive (+) to the negative (-). This will cause a short circuit, which will result in a spark, and may damage the batteries or the cables.

We recommend only running one cable at a time (positives first, then negatives) to minimise risk.

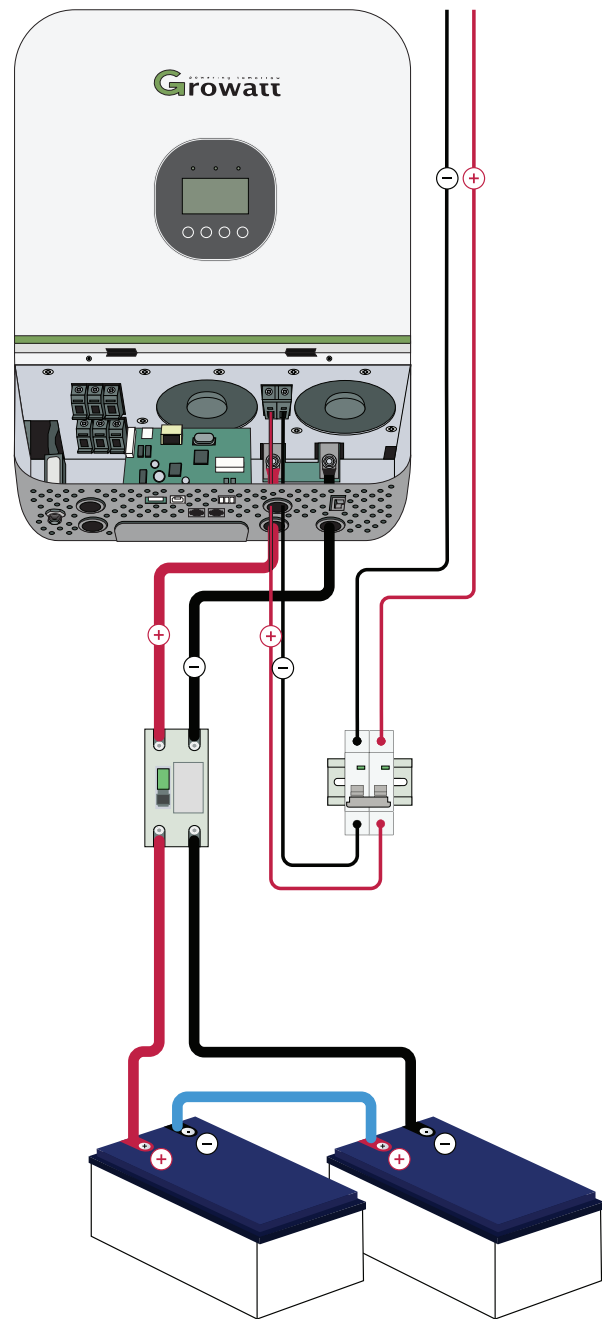

- 11 Once you've wired the batteries into the hybrid inverter, this is how your completed DIY wiring should look (excluding the panels). Double check everything is wired correctly and tightened before proceeding, to prevent damage to your system. Further steps will legally require an electrician.

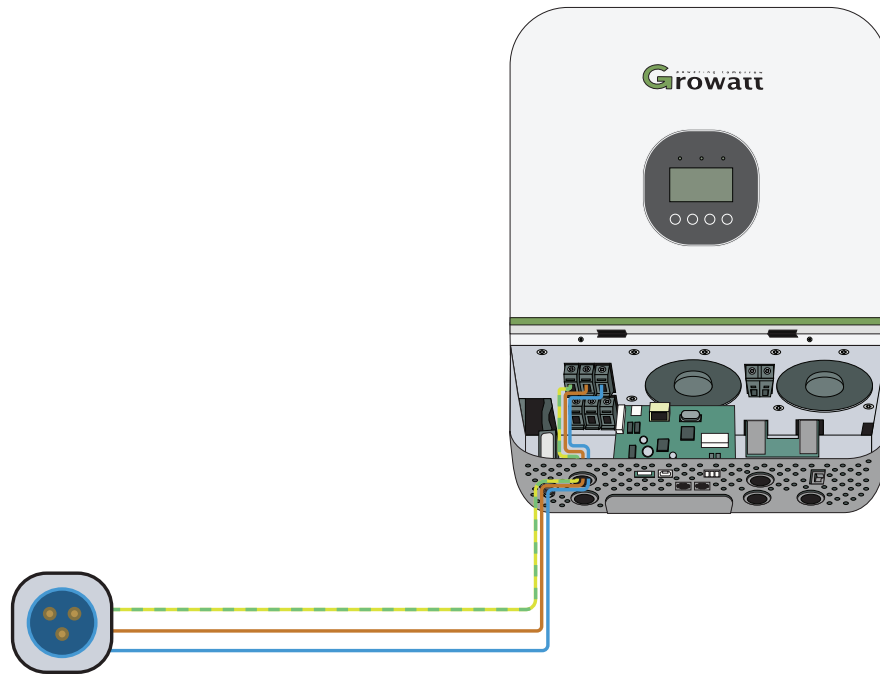

-
- 12** If using the utility / generator input, use AC cable rated for 40A. If using a plug, use a 32A rated plug.
-

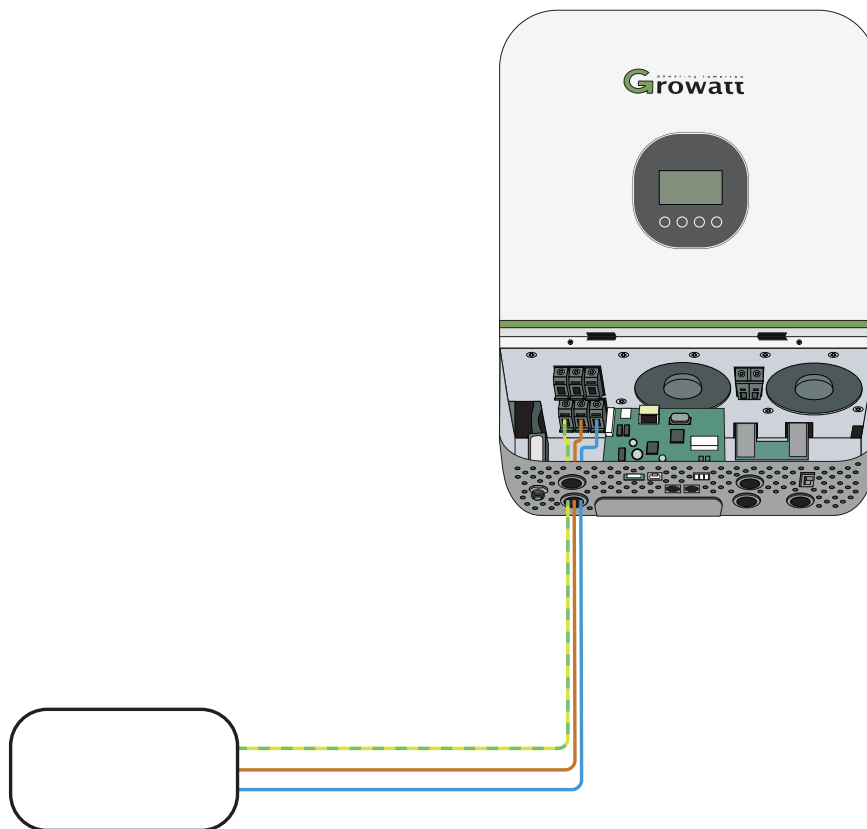

-
- 13** The hybrid inverter does not have an earth to neutral connection. This connection can be made at the main distribution board, unless the system is being used with a generator that also has a earth neutral connection.
-

START UP PROCEDURE

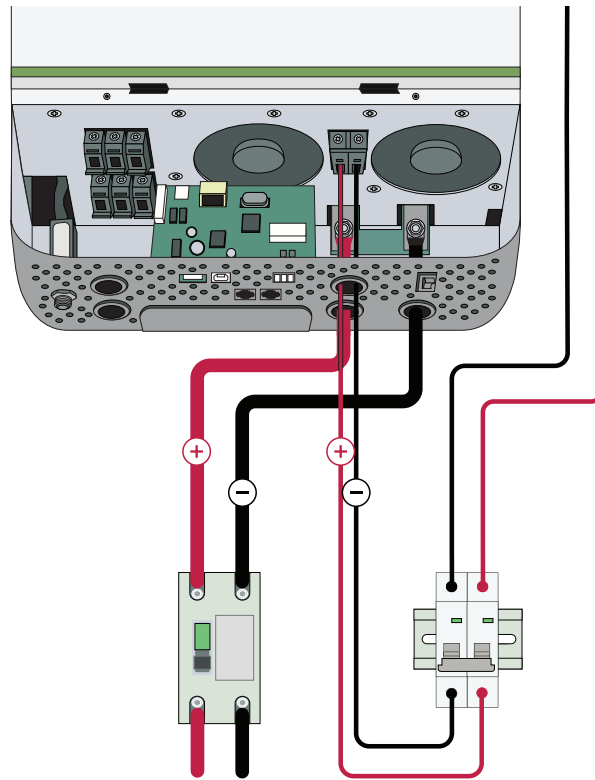

- 14 Switch on the circuit breakers in the following order. First switch on the battery to hybrid inverter breaker 125A MCCB. Then, the panels to the hybrid inverter CI5.
-

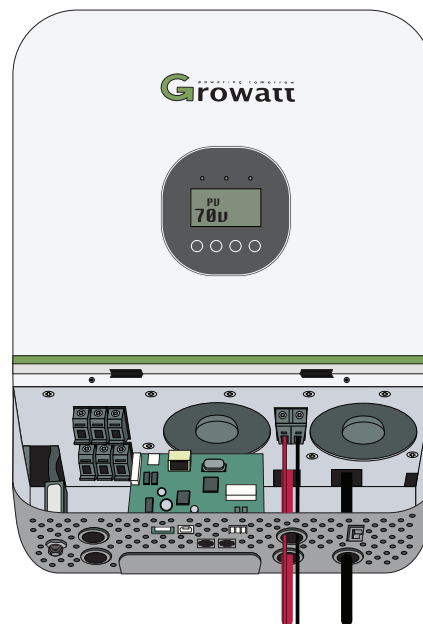

- 15 The Green LED on the PV Charge should flash, and the panel voltage should be around 65V-70V in full sunlight.
-
-

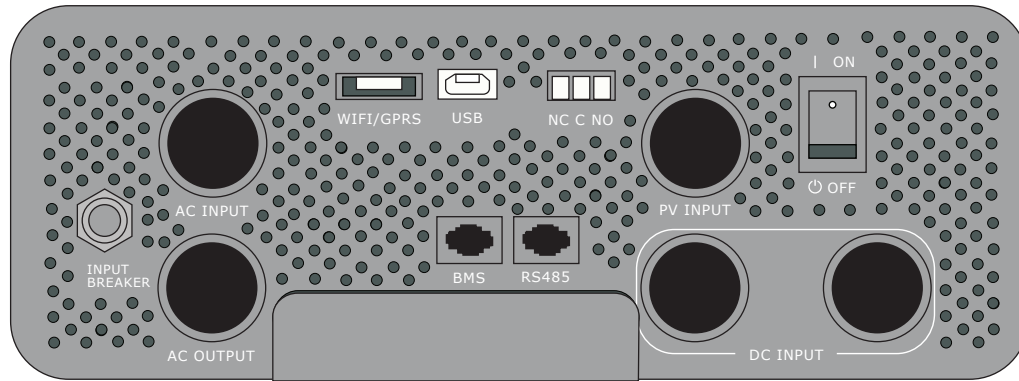

-
- 16** Flick the “ON” switch located on the bottom of the hybrid inverter, and refer to page 12 of the hybrid inverter manual to ensure normal operation.
-



-
- 17** The system is now fully functional. The last step is to select the GEL battery charging mode on the hybrid inverter.

Refer to page 16 - 17 of the hybrid inverter manual to change the battery type.

GETTING THE MOST OUT OF YOUR KIT



To get the most life out of your batteries they should not be discharged lower than 50%.

You can check the state of charge of the batteries on the hybrid inverter. Make sure the hybrid inverter is on this screen pictured above by pressing the UP/DOWN button.

The hybrid inverter displays the battery level in terms of voltage.

We have included this handy table that helps you convert from battery voltage to battery percentage.

The voltage will be higher than 25.5V when there is charge coming in from the solar panels. So if the battery voltage is showing as higher than 25.5V and there is less than 5 amps going into the batteries, the batteries will be at 100% charge.

Charge	Voltage
100%	25.5V-30V
90%	25.25V
80%	25V
70%	24.7V
60%	24.5V
50%	24.3V
40%	24V
30%	23.5V
20%	23V
10%	22.5V

BATTERY CARE INFORMATION

What is Battery Cycle Life and Depth of Discharge?

Depth of Discharge is how much energy is discharged from the battery before it is charged to 100% again. A common measurement is battery cycle life, at 50% D.O.D (Depth of Discharge). At 50% DOD the battery has 50% of its energy capacity discharged, before it begins charging again.

This is common in a solar situation where during the day the sun charges the battery, then during the rest of the day, the energy stored in the battery is used to power appliances. Cycle life measures how many cycles down to 50% it takes before the battery capacity is reduced to 60% of its capacity when brand new.

Do I need to add water to my battery?

No. Sealed lead acid batteries do not require additional water to maintain them.

What should I avoid when charging batteries?

1. Avoid mixing batteries of different size and age – you will always be limited to the weakest battery in the string. For optimum performance, you should be using matched cells.
2. Don't run devices off just one battery to get 12V. Use a 24V to 12V step down. This ensures that the current is shared equally between the batteries so that they are all put under equal stress so they all have the same lifespan.
3. Never go lower than 50% depth of discharge (or 24.3V) - not only will this permanently damage your battery, but it will void your warranty.
4. Always charge your batteries to 100% - leaving them partially charged will lead to sulfation and reduce your battery's capacity.
5. Don't let your batteries get too cold or too hot – about 20°C is an ideal temperature, and for best results, aim to keep them between 10°C to 30°C

What happens if I over-discharge batteries?

OVER-DISCHARGING is a problem caused by insufficient battery capacity resulting in the batteries being overworked. Discharges deeper than 50% (below 24.3V) significantly shorten the Cycle Life of a battery. Infrequent or inadequate recharging can also cause rapid sulfation – a buildup of lead sulfate crystals covering the battery plates.

This coverage deteriorates the overall efficiency and power storage capability of the battery, meaning over-discharging will result in a loss of battery capacity. It will also void your warranty.

How can you check a battery's performance?

As a battery gets older, it will not have the same amount of capacity it had when it was brand new. To test the capacity of the battery, you will need to discharge the battery using a constant draw. By knowing how much current is being drawn, measuring the voltage at the beginning and at the end of the test, and timing the test, you can calculate the battery's capacity. This can be a complex test, and should only be done if you suspect the batteries are failing.

TROUBLESHOOTING GUIDE

We've compiled this list of common problems our customers may encounter with their solar gear to help you solve any issues as fast as possible.

If you don't find the answers you need here, or your issue continues after implementing the given solution, please get in touch.

1. My solar panels are not putting out as much power as normal

Once you've determined the drop in power is not due to weather changes, check your panels for any shade or shadows.

Check both morning and afternoon in case the shadows are inconsistent. Make sure they're cleaned off, as things such as thick dust or bird droppings can affect your output. Finally, double check all your connections are clean and secure.

If none of these issues are causing your power drop, you'll need to send us some clear pictures of your hybrid inverter readings.

We need to see the battery voltage, solar panel voltage, and solar panel amps. Please send readings from the middle of the day with peak sun, as well as the end of the day or early morning.

2. My hybrid inverter keeps shutting off

Check your battery voltage, as hybrid inverters have an auto shut-off feature to protect them from damage when the voltage drops too low. The manual that came with your hybrid inverter will have this information, as well as a full troubleshooting guide.

3. My batteries aren't charging

It's likely that your batteries have been drawn very low, and are not able to charge fully if you continue to draw power. Check all the wiring is secure and undamaged, then turn off the breaker between the batteries and the hybrid inverter, leaving the others on, and let the batteries charge back up to full.

If you don't believe you have knowingly used enough power to drain the batteries, check all your appliances to see if something is using more power than it should.

4. My batteries drain very fast when the sun goes down

The hybrid inverter may read 100% while charging at the higher voltage, but then it will quickly drop down lower when there is no charge applied. This could be because the batteries charge at a higher voltage, so when the sun goes down the battery voltage will stabilize at a lower level.

It may also mean the batteries have been drained low, and they are not getting enough charge to be fully charged by the end of the day.

Try reducing your power usage for a few days to make sure the batteries are getting fully charged, but also make sure to check the solar panels are not being shaded during the day, or there is an appliance that has been left on. When customers notice less solar output the most common cause is shading - as we transition between winter and summer the sun's path changes, which can cast new shadows across the panels which weren't noticed when you first installed the system.

5. My hybrid inverter beeped, and the PV charge indicator was blinking

You may hear your hybrid inverter beep, and see an orange light blinking if you check quickly. This occurs when the battery voltage is too high. This can happen very occasionally when the hybrid inverter is charging the batteries completely.

It can happen when you have a very sunny day, and use a high draw appliance like a toaster - when the toaster stops the solar then works very quickly to top off the batteries, and can peak the voltage briefly. As it's a hybrid inverter, it is working to protect itself and your batteries, so it can sometimes be a little bit on the over protective side.

6. My hybrid inverter fan turns on all the time

You may notice the fan turning on even when you're not using a high load appliance. The hybrid inverter can sometimes be a little overprotective of itself, especially on warm days, and the fan will turn on when it doesn't seem necessary. Make sure there is sufficient airflow around your hybrid inverter and you should be fine.

CONTACT US

Our website: gridfree.store

Email us: info@gridfree.store

Message us on Facebook: [@GridFree.Store](https://www.facebook.com/GridFree.Store)

Give us a call: (09) 218 5533

Address: By Appointment– C4/27 Smales Road, East Tāmaki, Auckland, 2013

Hours: 9am-5pm, Monday-Friday

Kit viewings, demos, and pick ups at Auckland warehouse by appointment only.
Please give us a call and we'll be happy to set up a time to meet you.



GRIDFREE