

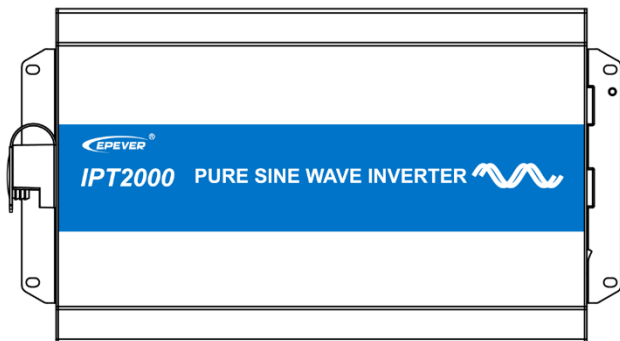

# Pure sine wave inverter

---

# USER MANUAL



## Model

IPT350, IPT500

IPT1000, IPT1500

IPT2000, IPT3000

IPT4000, IPT5000



# Contents

Important Safety Instructions.....	1
1 Overview .....	5
2 Appearance .....	7
3 Naming rule.....	13
4 Connection diagram .....	16
5 Installation .....	17
5.1 Attentions .....	17
5.2 Wire size and circuit breaker .....	17
5.3 Mounting .....	19
6 Protections .....	25
7 Troubleshooting.....	28
8 Maintenance.....	29
9 Specifications .....	30
Appendix 1 Disclaimers.....	39



# Important Safety Instructions





**Please reserve this manual for future review.**

This manual contains instructions on safety, installation, and operation for IPT series high-frequency pure sine wave inverter ("inverter" as referred to in this manual).

## 1. Explanation of symbols

Please read related literature accompanying the following symbols to enable users to use the product efficiently and ensure personal and property safety.

Please read the literature accompanying the following symbols.

Symbols	Definition
Tips:	Indicates any practical advice for reference
	<b>IMPORTANT:</b> Indicates a critical tip during the operation, if ignored, may cause the device to run in error.
	<b>CAUTION:</b> Indicates potential hazards. If not avoided, it may cause the device to be damaged.
	<b>WARNING:</b> Indicates the danger of electric shock. If not avoided, it would cause casualties.
	<b>WARNING HOT SURFACE:</b> Indicates the risk of high temperature, if not avoided, would cause scalds.
	Read the user manual carefully before any operation.

 <b>WARNING</b>	The entire system should be installed by professional and technical personnel.
--	--

## 2. Requirements for professional and technical personnel



- Professionally trained;
- Familiar with related safety specifications for the electrical system;
- Read this manual carefully and master related safety cautions.

## 3. Professional and technical personnel is allowed to do

- Install the inverter to a specified location.

- Conduct trial operations for the inverter.
- Operate and maintain the inverter.

#### 4. Safety cautions before installation

 <b>IMPORTANT</b>	<p>When you receive the inverter, check whether there is any damage in transportation. Contact the transportation company or our company in time for any problem.</p>
 <b>CAUTION</b>	<ul style="list-style-type: none"> <li>• When placing or moving the inverter, follow the instructions in the manual.</li> <li>• When installing the inverter, evaluate whether the operation area exists arc danger.</li> <li>• The inverter needs to be connected to a battery. The battery's minimum capacity (Ah) is recommended to be five times the current that equals the inverter's rated output power divided by the battery's voltage.</li> </ul>
 <b>WARNING</b>	<ul style="list-style-type: none"> <li>• Keep the inverter out of the reach of children.</li> <li>• This inverter is an off-grid type. It is strictly prohibited to connect the inverter to the grid. Otherwise, the inverter will be damaged.</li> <li>• This inverter is only allowed for stand-alone operation. It is prohibited to connect multiple units in parallel or series. Otherwise, the inverter will be damaged.</li> </ul>

#### 5. Safety cautions for mechanical installation



 <b>WARNING</b>	<ul style="list-style-type: none"> <li>• Before installation, ensure the inverter has no electrical connection.</li> <li>• Confirm enough heat dissipation space for the inverter before installation. Do not install the inverter in a harsh environment such as humid, greasy, flammable, explosive, or dust accumulation.</li> </ul>
---	---

#### 6. Safety cautions for electrical connection

 <b>CAUTION</b>	<ul style="list-style-type: none"> <li>• Check whether wiring connections are tight to avoid the danger of heat accumulation due to loose connections.</li> <li>• The protective grounding is connected to the ground. The cross-section of the wire should not be less than 4mm<sup>2</sup>.</li> <li>• The DC input voltage must strictly follow the parameter table. Too high or too low DC input voltage will affect the inverter's normal operation and may even damage</li> </ul>
---	---

	<p>it.</p> <ul style="list-style-type: none"> <li>• It is recommended that the connection length between the battery and the inverter be less than 3 meters. If greater than 3 meters, please reduce the current density of the connection wire.</li> <li>• A fuse or breaker should be used between battery and Inverter; the fuse or breaker's rated current should be twice the inverter rated input current.</li> <li>• DO NOT install the inverter close to the flooded lead-acid battery because the terminals' sparkle may ignite the hydrogen released by the battery.</li> </ul>
 <b>WARNING</b>	<ul style="list-style-type: none"> <li>• The AC output terminal is only for the load connection. Do NOT connect it to another power source or utility. Otherwise, the inverter will be damaged. Turn off the inverter when connecting loads.</li> <li>• Do not connect battery chargers or other similar products to the input terminal of the inverter. Otherwise, the inverter will be damaged.</li> </ul>

#### 7. Safety cautions for controller operation

 <b>WARNING</b> <b>HOT</b> <b>SURFACE</b>	<p>When the inverter is working, the shell will generate much heat, and the temperature is very high; please do not touch it.</p>
 <b>CAUTION</b>	<p>When the inverter is running, please do not open the cabinet.</p>
 <b>WARNING</b>	<p>The inverter's AC output is of high voltage, do not touch the wiring connection to avoid electric shock.</p>

#### 8. Dangerous operations which would cause electric arc, fire or explosion

- Touch the wire end that hasn't been insulation treated and may be electriferous.
- Touch the wiring copper row, terminals, or internal inverter modules that may be electriferous.
- The connection of the power cable is loose.
- Screw or other spare parts inadvertently falls into the inverter.
- Improper operations by untrained non-professional or technical personnel.

 <b>WARNING</b>	<p>Once an accident occurs, it must be handled by professional and technical personnel. Improper operations would cause more serious accidents.</p>
---	---

### 9. Safety cautions for stopping the inverter

- The internal conductive modules could be touched after the inverter stopped running for five minutes.
- The inverter is allowed to restart after removing the faults, which affects the safety performance.
- There are no serviceable parts inside. If any maintenance service is required, please contact our service personnel.



**WARNING**

Do NOT touch or open the shell after the inverter is powered off within ten minutes.

### 10. Safety cautions for inverter maintenance

- It is recommended to check the inverter with testing equipment to ensure no voltage and current.
- When conducting electrical connection and maintenance, post a temporary warning sign or put up barriers to prevent the unrelated personnel from entering the electrical connection or maintenance area.
- An improper operation of the inverter may cause personal injury or equipment damage.
- It is recommended to wear an antistatic wrist strap or avoid unnecessary contact with the circuit board.



# 1 Overview

IPT is a new generation of pure sine wave inverter, which can be customized according to customer needs. Adopting the voltage and current double closed-loop control algorithm brings the inverter a faster response and a lower THD. The inverter selects key components with a high power density and long lifespan to provide a stable and reliable power guarantee.

1000W and above IPT products are equipped with two AC outlets. It supports two AC loads simultaneously (**Note: the total load power cannot exceed the rated power**). At the same time, users can choose various human-computer interaction solutions, which is convenient to control real-time parameters.

The inverter can be widely used in DC to AC areas, such as solar AC power system, vehicle system, RV power supply, security monitoring system, emergency lighting system, field power system, household power system, etc. With industrial standard EMC (Electro Magnetic Compatibility) characteristics, the inverter is also suitable for occasions with high power quality requirements.

## Features:

- Industrial standard, cost-effective
- Customizable input reverse polarity protection and surge current suppression technology
- Completely electrically isolated design for input and output
- Full digital double closed-loop control
- Excellent EMC characteristic, widely applied to higher quality power system
- Advanced SPWM technology and pure sine wave output.
- Double AC output ports (suitable for 1000W and above) to support two AC loads working at the same time
- Multi AC outlets to meet the users' needs of different countries and regions
- High power density and high-quality components to ensure the reliability
- Output power factor up to 1
- Low loss of zero loads and standby. Low THD (Total Harmonic Distortion). High conversion efficiency
- Extensive input under voltage/over-voltage, output overload/short circuit/overheating Instruction
- Air cooling controlled by temperature and load
- Remote control by the phone APP and PC software

- Configurable output voltage and output frequency<sup>①</sup>
  - RS485 com. port<sup>②</sup>, to support various optional accessories
  - RJ11 port<sup>②</sup> to connect a remote switch, convenient to start/stop device and view errors remotely
  - External switch contact design to allow remote control
  - EN/IEC62109-1/2, EN61000-6-2/4 and FCC approved
- ① **Related parameters' settings can only be operated through the remote meter, mobile phone APP, or PC software.**
- ② **For inverters with 12V/24V input voltage, the RS485/RJ11 port has NO communication isolation design. This function (communication isolation design) is just for inverters with 48V input voltage.**

## 2 Appearance

- IPT350-xx

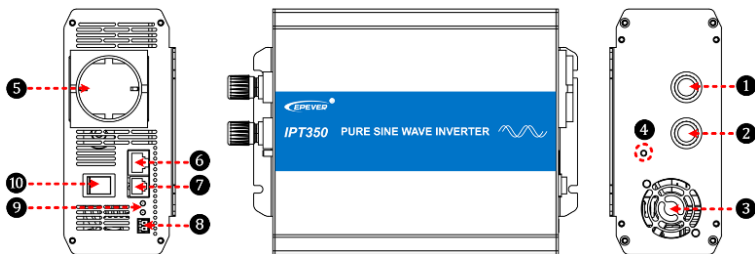

- IPT500-xx

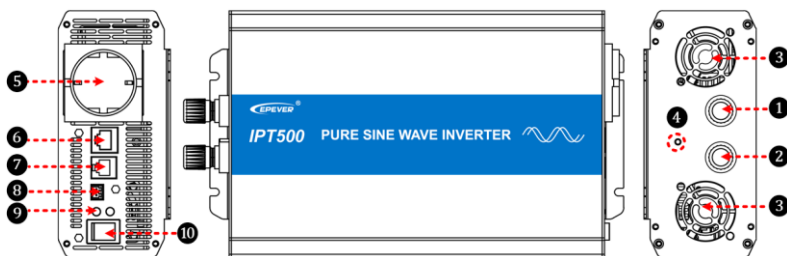

- IPT1000-xx

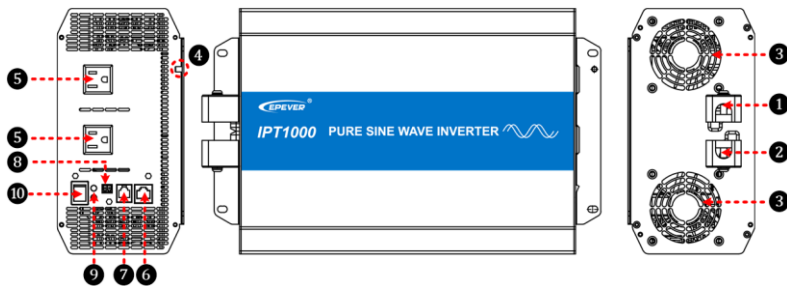

- IPT1500-XX

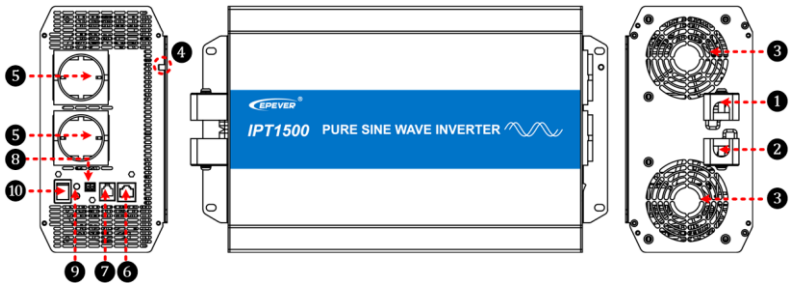

- IPT2000-XX

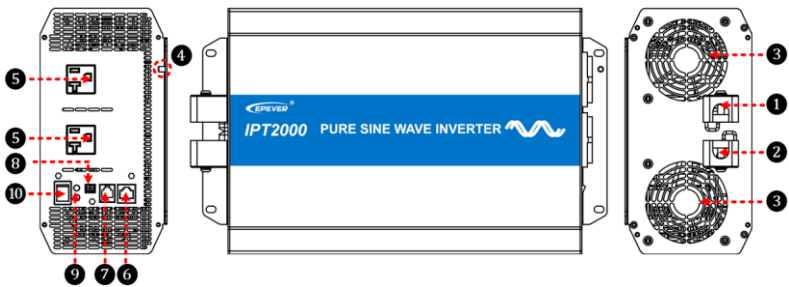

- IPT3000-XX

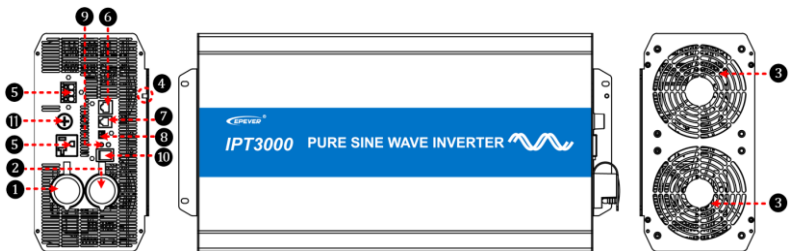

- IPT4000-XX

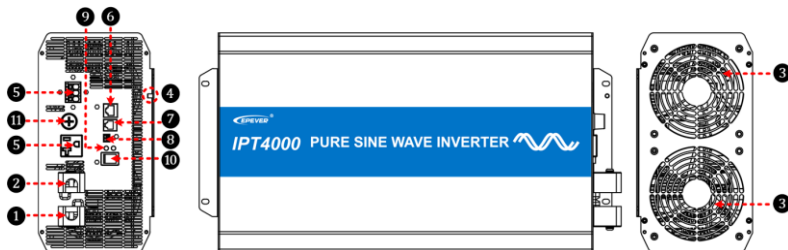

- IPT5000-42

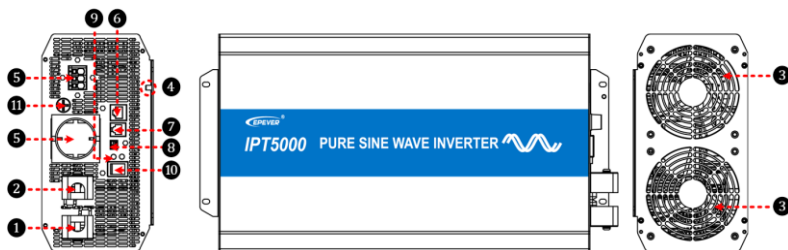

**CAUTION**

The above products' appearance is only used as the terminal description. The DC input and AC output port vary with different models; please refer to the actual product appearance for details.

①	DC input terminal positive	⑥	RS485 communication port <sup>③</sup>
②	DC input terminal negative	⑦	Remote switch port(RJ11)
③	Cooling fan <sup>①</sup>	⑧	External switch port
④	Grounding terminal	⑨	Indicator <sup>④</sup>
⑤	AC outlet <sup>②</sup>	⑩	Inverter switch
		⑪	Fuse terminal <sup>⑤</sup>

① Cooling fan

- Conditions to start the cooling fan:

Heat sink temperature is higher than 45°C or The internal inverter temperature is higher than 45°C or The output power is higher than 700W	IPT1500-11
	IPT1500-21
	IPT1500-41
	IPT1500-12
	IPT1500-22
	IPT1500-42
Heat sink temperature is higher than 45°C or The internal inverter temperature is higher than 45°C or The output power is higher than 50% of the rated power	IPT350-11
	IPT350-21
	IPT350-12
	IPT350-22
	IPT500-11
	IPT500-21
	IPT500-12
	IPT500-22
	IPT1000-11
	IPT1000-21
	IPT1000-12
	IPT1000-22
	IPT2000-11
	IPT2000-21
	IPT2000-41
	IPT2000-12
	IPT2000-22
	IPT2000-42
	IPT3000-11
	IPT3000-21
	IPT3000-41
IPT3000-12	
IPT3000-22	
IPT3000-42	
IPT4000-41	
IPT4000-42	
IPT5000-42	

- **Conditions to stop the cooling fan:**

<p>Heat sink temperature is lower than 40°C and The internal inverter temperature is lower than 40°C and The output power is lower than 300W</p>	IPT1000-11
	IPT1000-21
	IPT1000-12
	IPT1000-22
<p>Heat sink temperature is lower than 40°C and The internal inverter temperature is lower than 40°C and The output power is lower than 500W</p>	IPT1500-11
	IPT1500-21
	IPT1500-41
	IPT1500-12
	IPT1500-22
<p>Heat sink temperature is lower than 40°C and The internal inverter temperature is lower than 40°C and The output power is lower than 40% of the rated power</p>	IPT1500-42
	IPT2000-11
	IPT2000-21
	IPT2000-41
	IPT2000-12
	IPT2000-22
	IPT2000-42
	IPT3000-11
	IPT3000-21
	IPT3000-41
	IPT3000-12
	IPT3000-22
	IPT3000-42
<p>Heat sink temperature is lower than 40°C and The internal inverter temperature is lower than 40°C and The output power is lower than 30% of the rated power</p>	IPT4000-41
	IPT4000-42
	IPT5000-42
	IPT350-11
	IPT350-21
	IPT350-12
	IPT350-22
IPT500-11	
IPT500-21	
IPT500-12	
IPT500-22	

- ② The AC outlets vary with different products. Please refer to Chapter 3 Naming rule for the specific supported outlet types.
- ③ The RS485 communication port can be connected to the remote meter, Bluetooth module, WIFI module, PC, etc., for parameter setting and remote monitoring.
- ④ Indicators include the Power indicator and Fault indicator. The indicator and buzzer status under different working conditions are shown in the table below.

Power indicator	Fault indicator	Buzzer	Status
Green ON	Red OFF	No beeps	Output voltage normal
Green slowly flashing(1/4Hz)	Red OFF	Buzzer beeps.	Input under voltage
Green fast flashing (1Hz)	Red OFF	Buzzer beeps.	Input over voltage
Green OFF	Red ON solid	Buzzer beeps.	Inverter over temperature Heat sink over temperature
Green OFF	Red fast flashing (1Hz)	Buzzer beeps.	Load short-circuit
Green ON	Red slowly flashing(1/4Hz)	Buzzer beeps.	Overload
Green OFF	Red OFF	Buzzer beeps.	Output voltage abnormal

- ⑤ The main purpose of the fuse terminal ⑪ is to protect the AC outlet, where the connected load cannot exceed the marked 10A or 20A.



### 3 Naming rule

IPT 5000 - 4 2 (TC / RS)

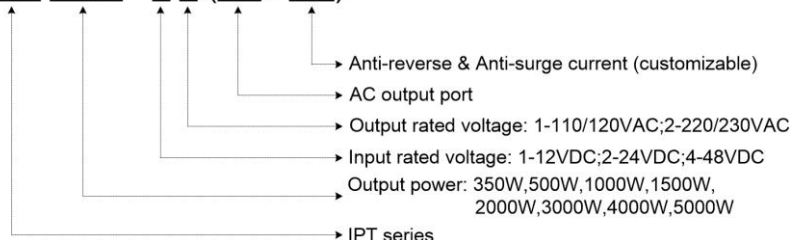

➤ **Instructions for the anti-reverse and anti-surge current protection:**

Product type	Suffix	Definition
Standard products	No	Without reverse polarity and anti-surge current protection
Customized products	R	With reverse polarity protection, without anti-surge current protection
	S	Without reverse polarity protection, with anti-surge current protection
	RS	With reverse polarity and anti-surge current protection

➤ **Explanations for the AC output port:**

- **Single terminal, single outlet or 2 pcs outlets for the AC output port**

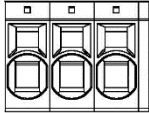
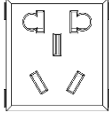
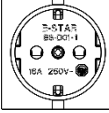
Type	Applicable product	Number
T Terminal 	IPT series	1 pcs
C - Chinese dual-socket 	IPT350/500-x2	1 pcs
	IPT1000/1500/2000-x2	2 pcs
E - European 	IPT350/500-x2	1 pcs
	IPT1000/1500/2000/3000-x2	2 pcs

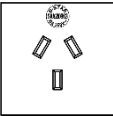
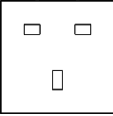
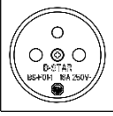
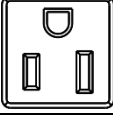
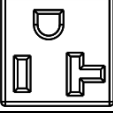
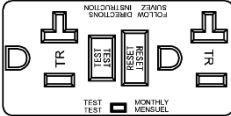
A - Australia		IPT350/500-x2	1 pcs
		IPT1000/1500/2000-x2	2 pcs
UK - United Kingdom		IPT350/500-x2	1 pcs
		IPT1000/1500/2000-x2	2 pcs
F - French		IPT350/500-x2	1 pcs
		IPT1000/1500/2000/3000-x2	2 pcs
N - North American		IPT350/500-x1	1 pcs
		IPT1000/1500-x1	2 pcs
		IPT2000-x1	2 pcs
GFCI - Ground Fault Circuit Interrupt★		IPT1000/1500/2000-x1	1 pcs

- 1 pcs terminal + 1 pcs outlet for the AC output port

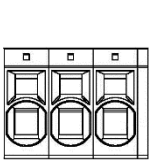
Type		Applicable product	Number
TA - Terminal + Australia	 T: Terminal	IPT3000-x2	Terminal*1
TC - Terminal + Chinese dual-socket		IPT4000/5000-42	Outlet*1

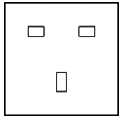
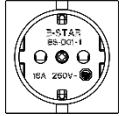
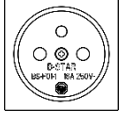
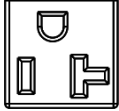
TUK - Terminal + United Kingdom			
TE - Terminal + European		IPT4000/5000-42	Terminal*1 Outlet*1
TF - Terminal + French			
TN - Terminal + America		IPT3000-x1 IPT4000-41	Terminal*1 Outlet*1

★ GFCI outlets need to be tested after power-on to ensure proper operation.

➤ **Preparation**

Connect a circuit breaker and an AC load (it is recommended to use a night light to observe the status conveniently) to the GFCI outlet. Turn on the inverter after confirming the wiring.

➤ **Testing**

- 1) If the red LED is ON solid, it indicates that the GFCI outlet is damaged; please replace a new one.
- 2) If the LED is green ON after it flashes in red three times, connect the circuit breaker, and the night light will be turned on. Then, press the "TEST" button to observe the testing status:
  - ① The "TEST" button always pops up, and the night light keeps ON solid. It indicates that the GFCI wiring is an error; please correct the wrong wiring.
  - ② The "TEST" button goes down, while the "RESET" button pops up. The LED and the night light are turned off, indicating the GFCI outlet is normal (**Note: Press the "RESET" button again to recover the load output**).

## 4 Connection diagram

### ➤ The DC input and AC outlets located on different sides

The DC input and AC outlets are located on different sides, such as IPT350-xx, IPT500-xx, IPT1000-xx, IPT1500-xx, IPT2000-xx, and IPT3000-42. The following takes IPT2000-2x as an example to introduce the system connection.

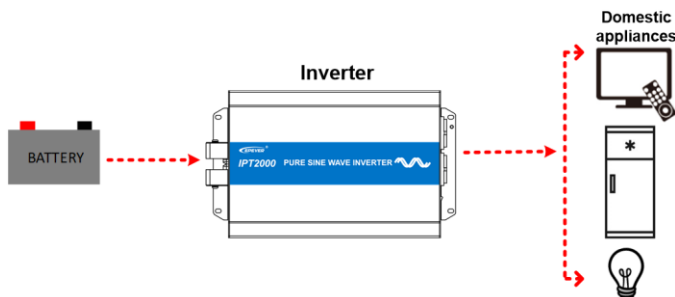

### ➤ The DC input and AC outlets located on the same side

The DC input and AC outlets are located on the same side, such as IPT3000-1x/2x, IPT3000-41, IPT4000-4x, and IPT5000-42. The following takes IPT3000-1x as an example to introduce the system connection.

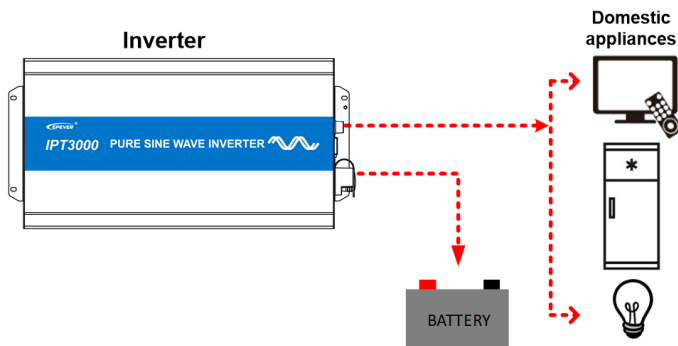

#### CAUTION

It is recommended to directly connect the inverter DC input terminal to the battery terminal. DO NOT connect it to the charge source terminal. Otherwise, the charging voltage spikes of the charge source may cause over-voltage protection of the inverter.

# 5 Installation

## 5.1 Attentions

- Read all the installation instructions carefully in the manual before installation.
- Be very careful when installing the batteries. When installing the open-type lead-acid battery, please wear eye protection and rinse with clean water in time for battery acid contact.
- Keep the battery away from any metal objects, which may cause a short circuit of the battery.
- Loose power connectors and corroded wires may result in high heat, melt wire insulation, burn surrounding materials, or cause a fire. Ensure tight connections and secure cables with cable clamps to prevent them from swaying in moving applications.
- The DC input voltage must strictly follow the parameter table. Too high or too low DC input voltage affects the normal operation and may damage the inverter. DC input 12V: Surge voltage < 20V. DC input 24V: Surge voltage < 40V. DC input 48V: Surge voltage < 80V.
- Select the system cables according to 3.5A/mm<sup>2</sup> or less current density.
- Avoid direct sunlight and rain infiltration when installing it outdoor.
- After turning off the power switch, do not open or touch the internal component immediately. Performing related operations after 10 minutes are recommended.
- Do not install the inverter in a harsh environment such as humid, greasy, flammable, explosive, or dust accumulation.
- The AC output is of high voltage, do not touch the wiring connection to avoid electric shock.
- To prevent injury, do not touch the fan while it is working.

## 5.2 Wire size and circuit breaker

The wiring and installation methods conform to the national and local electrical code requirements.

### ➤ Wire, terminals, and circuit breaker selection for battery

Model	Battery wire size	Ring terminal	Circuit breaker
IPT350-11	6mm <sup>2</sup> /10AWG	RNB5.5-6	DC/2P-40A
IPT350-12	6mm <sup>2</sup> /10AWG	RNB5.5-6	DC/2P-40A
IPT350-21	2.5mm <sup>2</sup> /13AWG	RNB3.5-6	DC/2P-32A
IPT350-22	2.5mm <sup>2</sup> /13AWG	RNB3.5-6	DC/2P-32A
IPT500-11	10mm <sup>2</sup> /7AWG	RNB8-6S	DC/2P—63A
IPT500-12	10mm <sup>2</sup> /7AWG	RNB8-6S	DC/2P—63A

IPT500-21	6mm <sup>2</sup> /10AWG	RNB5.5-6	DC/2P-32A
IPT500-22	6mm <sup>2</sup> /10AWG	RNB5.5-6	DC/2P-32A
IPT1000-11	25mm <sup>2</sup> /3AWG	RNB38-6	DC/2P-125A
IPT1000-12	25mm <sup>2</sup> /3AWG	RNB38-6	DC/2P-125A
IPT1000-21	16mm <sup>2</sup> /5AWG	RNB14-6S	DC/2P-63A
IPT1000-22	16mm <sup>2</sup> /5AWG	RNB14-6S	DC/2P-63A
IPT1500-11	25mm <sup>2</sup> /3AWG* 2	RNB60-6	DC-100A(2P in parallel)
IPT1500-12	25mm <sup>2</sup> /3AWG* 2	RNB60-6	DC-100A(2P in parallel)
IPT1500-21	16mm <sup>2</sup> /5AWG	RNB14-6S	DC/2P-125A
IPT1500-22	16mm <sup>2</sup> /5AWG	RNB14-6S	DC/2P-125A
IPT1500-41	10mm <sup>2</sup> /7AWG	RNB14-6S	DC/2P-63A
IPT1500-42	10mm <sup>2</sup> /7AWG	RNB14-6S	DC/2P-63A
IPT2000-11	35mm <sup>2</sup> /2AWG* 2	RNB70-10	DC-125A(2P in parallel)
IPT2000-12	35mm <sup>2</sup> /2AWG* 2	RNB70-10	DC-125A(2P in parallel)
IPT2000-21	35mm <sup>2</sup> /2AWG	RNB38-6	DC/2P-125A
IPT2000-22	35mm <sup>2</sup> /2AWG	RNB38-6	DC/2P-125A
IPT2000-41	16mm <sup>2</sup> /5AWG	RNB14-6S	DC/2P-63A
IPT2000-42	16mm <sup>2</sup> /5AWG	RNB14-6S	DC/2P-63A
IPT3000-11	25mm <sup>2</sup> /3AWG*4	RNB80-10	DC-125A(3P in parallel)
IPT3000-12	25mm <sup>2</sup> /3AWG*4	RNB80-10	DC-125A(3P in parallel)
IPT3000-21	25mm <sup>2</sup> /3AWG*2	RNB60-6	DC-100A(2P in parallel)
IPT3000-22	25mm <sup>2</sup> /3AWG*2	RNB60-6	DC-100A(2P in parallel)
IPT3000-41	25mm <sup>2</sup> /3AWG	RNB22-6S	DC/2P-125A
IPT3000-42	25mm <sup>2</sup> /3AWG	RNB22-6S	DC/2P-125A
IPT4000-41	35mm <sup>2</sup> /2AWG	RNB38-6	DC/2P-125A
IPT4000-42	35mm <sup>2</sup> /2AWG	RNB38-6	DC/2P-125A
IPT5000-42	25mm <sup>2</sup> /3AWG*2	RNB60-6	DC-100A(2P in parallel)



**CAUTION**

The above wire size and circuit breaker size are for reference only; please choose a suitable wire and circuit breaker according to the actual situation.

➤ **Wire and circuit breaker selection for AC output**

Model	Wire size	Circuit breaker
IPT350-11	1mm <sup>2</sup> /18AWG	AC/2P-6A
IPT350-12	1mm <sup>2</sup> /18AWG	AC/2P-6A
IPT350-21	1mm <sup>2</sup> /18AWG	AC/2P-6A
IPT350-22	1mm <sup>2</sup> /18AWG	AC/2P-6A
IPT500-11	1mm <sup>2</sup> /18AWG	AC/2P-10A
IPT500-12	1mm <sup>2</sup> /18AWG	AC/2P-6A
IPT500-21	1mm <sup>2</sup> /18AWG	AC/2P-10A
IPT500-22	1mm <sup>2</sup> /18AWG	AC/2P-6A

IPT1000-11	2.5mm <sup>2</sup> /13AWG	AC/2P—16A
IPT1000-12	1.5mm <sup>2</sup> /15AWG	AC/2P—10A
IPT1000-21	2.5mm <sup>2</sup> /13AWG	AC/2P—16A
IPT1000-22	1.5mm <sup>2</sup> /15AWG	AC/2P—10A
IPT1500-11	4mm <sup>2</sup> /11AWG	AC/2P—25A
IPT1500-12	1.5mm <sup>2</sup> /15AWG	AC/2P—10A
IPT1500-21	4mm <sup>2</sup> /11AWG	AC/2P—25A
IPT1500-22	1.5mm <sup>2</sup> /15AWG	AC/2P—10A
IPT1500-41	4mm <sup>2</sup> /11AWG	AC/2P—25A
IPT1500-42	1.5mm <sup>2</sup> /15AWG	AC/2P—10A
IPT2000-11	4mm <sup>2</sup> /11AWG	AC/2P—32A
IPT2000-12	2.5mm <sup>2</sup> /13AWG	AC/2P—16A
IPT2000-21	4mm <sup>2</sup> /11AWG	AC/2P—32A
IPT2000-22	2.5mm <sup>2</sup> /13AWG	AC/2P—16A
IPT2000-41	4mm <sup>2</sup> /11AWG	AC/2P—32A
IPT2000-42	2.5mm <sup>2</sup> /13AWG	AC/2P—16A
IPT3000-11	6mm <sup>2</sup> /10AWG	AC/2P—50A
IPT3000-12	4mm <sup>2</sup> /11AWG	AC/2P—25A
IPT3000-21	6mm <sup>2</sup> /10AWG	AC/2P—50A
IPT3000-22	4mm <sup>2</sup> /11AWG	AC/2P—25A
IPT3000-41	6mm <sup>2</sup> /10AWG	AC/2P—50A
IPT3000-42	4mm <sup>2</sup> /11AWG	AC/2P—25A
IPT4000-41	6mm <sup>2</sup> /10AWG	AC/2P—63A
IPT4000-42	4mm <sup>2</sup> /11AWG	AC/2P—32A
IPT5000-42	4mm <sup>2</sup> /11AWG	AC/2P—40A



#### CAUTION

- The above wire size and circuit breaker size are for reference only; please choose a suitable wire and circuit breaker according to the actual situation.
- The wire size is only for reference. Suppose there is a long distance between the inverter and the battery. In that case, larger wires shall be used to reduce the voltage drop and improve the system performance.
- The above wire size and circuit breaker size are for reference; please choose a suitable wire and circuit breaker according to the actual situation.

## 5.3 Mounting

### Installation procedures:

**Step1: Professional personnel reads this manual carefully.**

**Step 2: Determine the installation location and heat-dissipation space**

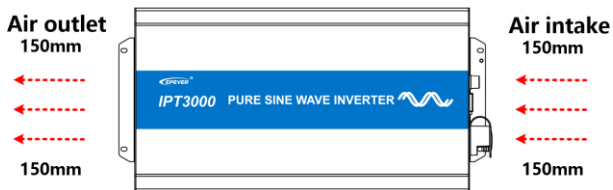

The inverter shall be installed in a place with sufficient airflow through the dissipation pad of the inverter.

And a minimum clearance of 150mm from the upper and lower edges of the inverter is recommended to ensure natural thermal convection. The following takes IPT3000-1x as an example to introduce the wiring.



 <b>CAUTION</b>	Ventilation is highly recommended if mounted in an enclosure.
---	---

### Step3: Wiring

 <b>WARNING</b>	The AC loads shall be determined by the continuous output power of the inverter. The surge power of the AC load must be lower than the instantaneous surge power of the inverter, or the inverter will be damaged.
 <b>CAUTION</b>	<ul style="list-style-type: none"> <li>• Turn off the inverter switch before wiring.</li> <li>• Please do not connect the circuit breaker or fuse during the wiring and ensure that the poles' leads are connected correctly.</li> <li>• A fuse whose current is 2 to 2.5 times the inverter's rated current must be installed on the battery end. Distance between them is not more than 150mm.</li> <li>• The terminals and ports on the side vary from the inverter models.</li> </ul>

Wiring sequence (The following wiring sequence is illustrated in the appearance "IPT3000-11", wiring positions of other inverters. Please refer to chapter 2 [Appearance](#) for reference.)

#### 1. Ground line

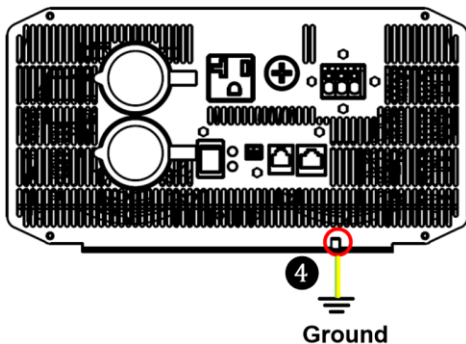



## 2. Battery

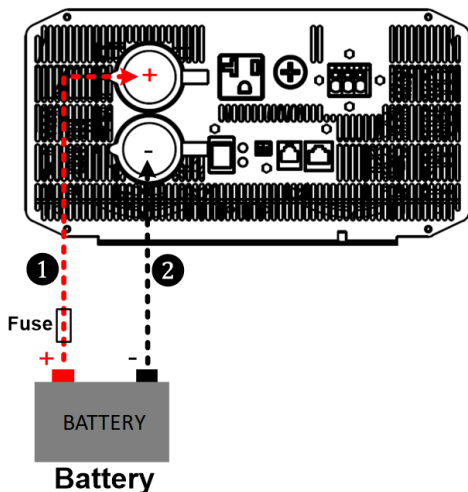

- 1) **Definition of the AC output port** (it varies with different product models; please refer to the actual product.)

The AC output ports of IPT3000-11 include AC terminal and North American standard outlets.

The following takes the AC terminal as an example.) It is recommended to use a multi-stranded wire with a wire diameter of not more than  $4\text{mm}^2$ .

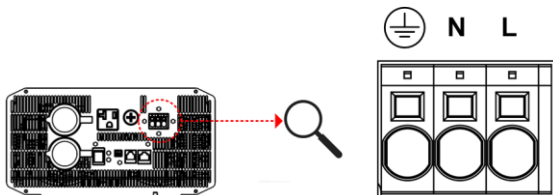

- + It is recommended to use multi-stranded wire with a wire diameter of not more than  $4\text{mm}^2$ .
- + Add solder to the connection point when selecting the multi-stranded wire and directly insert it into the corresponding port.

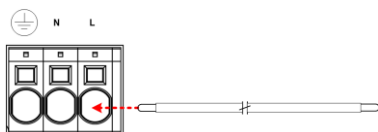

- ✦ Turn off the inverter before removing the wiring. Then, insert a sharp tool into the small hole (on the top of the port) and pull out the wiring forcefully.

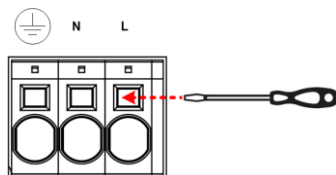

- 2) Connect the AC load

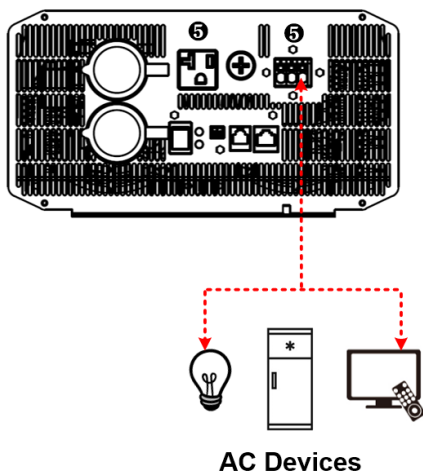

### 3. Optional accessories

- 1) RS485 communication port

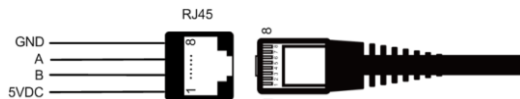

#### RJ45 Pin Definition:

Pin	Definition	Instruction	Pin	Definition	Instruction
1	+5VDC	5V/200mA	5	RS485-A	RS485-A
2	+5VDC		6	RS485-A	
3	RS485-B	RS485-B	7	GND	Power GND
4	RS485-B		8	GND	

## 2) Connect optional accessories

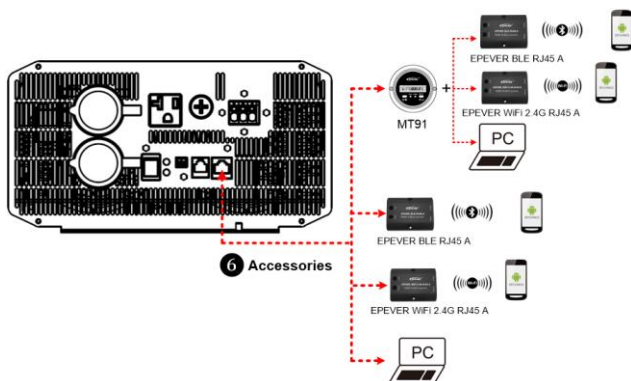

## 4. Remote switch (RJ11)

### 1) RJ11 port

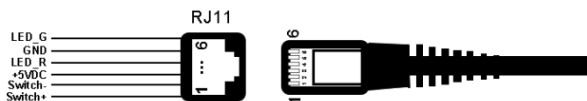

### RJ11 Pin Definition:

Pin	Definition	Instruction	Pin	Definition	Instruction
1	Switch+	Switch+	4	LED_R	Red light drive
2	Switch-	Switch-	5	GND	Power GND
3	+5VDC	5V/200mA	6	LED_G	Green light drive

### 2) Connect remote switch

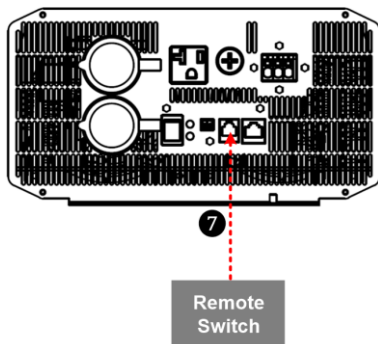

#### Step 4: Power on the inverter

- (1) Connect the breaker at the inverter input terminal or the fuse at the battery terminal.
- (2) Turn on the inverter switch, and the green indicator will be lighted on, which states a normal AC output.
- (3) Connect the breaker at the AC load terminal, turn on the AC loads one by one and check the system working status.



#### CAUTION

When supplying power for different loads, it is recommended to first turn on the load with a large impulse current. And then turn on the load with a smaller impulse current after the load output is stable.

- (4) If the FAULT indicator flashes red and the buzzer alarms after powering the inverter, please immediately turn off the load and the inverter. Clear the faults according to Chapter [8 Troubleshooting](#). After clearing the faults, please operate the inverter again by following the above steps.

## 6 Protections

### 1) Input voltage protection

- **The following rules must be followed when modifying the battery's input voltage parameters:**
  - Over voltage limiting voltage ( $16.2/32.2/64.4V$ )  $\geq$  Over voltage disconnect voltage  $\geq$  Over voltage reconnect voltage  $+1V$ .
  - Over voltage reconnect voltage  $\geq$  Low voltage reconnect voltage.
  - Low voltage reconnect voltage  $\geq$  Low voltage disconnect voltage  $+1V$ .
  - Low voltage disconnect voltage  $\geq$  Low voltage limiting voltage ( $10.5/21/42V$ ).
- **Detail status is shown as the following when the input voltage protection occurs.**

Input voltage protection	Status
Over voltage protection	The output is switched OFF immediately. The green indicator fast flashes. Buzzer beeps.
Over voltage recovery protection	The green indicator is ON solid. The output voltage is normal.
Low voltage protection	The output is switched OFF immediately. The green indicator Slowly flashes. Buzzer beeps.
Low voltage recovery protection	The green indicator is ON solid. The output voltage is normal.

 <b>CAUTION</b>	<p>Although the inverter is supplied with the input over-voltage protection, the surge voltage cannot higher than 20V for the 12V system, not higher than 40V for the 24V system, and not higher than 80V for the 48V system. Otherwise, the inverter may be damaged.</p>
---	---

### Overload protection

IPT350-11 IPT350-12 IPT350-21 IPT350-22	$S=1.2P_o$ (S: Output power; $P_o$ : Rated power)	The output is switched OFF after 1 minute. Buzzer beeps. Red indicator slowly flashes.
IPT500-11 IPT500-12 IPT500-21 IPT500-22	$S=1.5P_o$ (S: Output power; $P_o$ : Rated power)	The output is switched OFF after 30 seconds. Buzzer beeps. Red indicator slowly flashes.
IPT1000-11 IPT1000-12	$S=1.8P_o$ (S: Output power; $P_o$ : Rated power)	The output is switched OFF after 10 seconds.

IPT1000-21 IPT1000-22 IPT1500-11 IPT1500-12 IPT1500-21 IPT1500-22 IPT1500-41 IPT1500-42 IPT2000-11 ★ IPT2000-12 IPT2000-21 IPT2000-22 IPT2000-41 IPT2000-42 IPT3000-21 ★ IPT3000-22 ★ IPT3000-41 IPT3000-42		Buzzer beeps. Red indicator slowly flashes.
	$S > 2P_e$ (Input rated voltage) (S: Output power; $P_e$ : Rated power)	The output is switched OFF after 5 seconds. Buzzer beeps. Red indicator slowly flashes.

 <b>CAUTION</b>	When the overload protection happens, the AC output will be recovered automatically three times (recover after 5s, 10s, 15s separately). After three times recovery attempts fail, you need to restart the inverter to recover the AC output.
---	---

★When the overload protection happens on IPT2000-11, IPT3000-21 or IPT3000-22, the AC output is shut down directly and cannot be recovered automatically.

IPT3000-11 IPT3000-12 IPT4000-41 IPT4000-42	$S = 1.2P_e$ (S: Output power; $P_e$ : Rated power)	The output is switched OFF after 1 minute. Buzzer beeps. Red indicator slowly flashes.
	$S = 1.7P_e$ (S: Output power; $P_e$ : Rated power)	The output is switched OFF after 10 seconds. Buzzer beeps. Red indicator slowly flashes.
	$S > 1.7P_e$ (Input rated voltage) (S: Output power; $P_e$ : Rated power)	The output is switched OFF after 5 seconds. Buzzer beeps. Red indicator slowly flashes.
IPT5000-42	$S = 1.2P_e$ (S: Output power; $P_e$ : Rated power)	The output is switched OFF after 1 minute. Buzzer beeps. Red indicator slowly flashes.
	$S = 1.4P_e$ (S: Output power; $P_e$ : Rated power)	The output is switched OFF after 10 seconds. Buzzer beeps.

		Red indicator slowly flashes.
	$S > 1.4P_n$ (Input rated voltage) (S: Output power; $P_n$ : Rated power)	The output is switched OFF after 5 seconds. Buzzer beeps. Red indicator slowly flashes.

 <b>CAUTION</b>	<p>When the overload protection happens, the AC output cannot recover automatically. The AC output will be shut down according to the multiple of the overload. You can recover the AC output after clearing the overload faults and restarting the inverter.</p>
---	---

#### 4) Output short circuit protection

Faults	Instruction
<p>The output is switched OFF immediately. Buzzer beeps. Red indicator fast flashes.</p>	<p>Note: When the short circuit protection happens, the AC output will be recovered automatically three times (recover after 5s, 10s, 15s separately). After three times recovery attempts fail, you need to restart the inverter to recover the AC output.</p>

#### 5) Inverter over temperature protection

Faults	Instruction
<p>The red indicator is ON solid.</p>	<p>The inverter stops working after the heat sink's temperature, or the internal modules go higher than a set value.</p>
<p>Red indicator OFF</p>	<p>The inverter resumes work after the temperature of the heat sink, or the internal modules are lower than a set value.</p>

## 7 Troubleshooting



**WARNING**

A high voltage occurs inside the inverter. DO NOT try to repair or maintain the inverter by yourself, and it may cause an electric shock.

No.	Faults	Possible reasons	Troubleshooting
1	Green indicator Slowly flashes (1/4Hz) Red indicator turns OFF Buzzer beeps	The DC input voltage is too low.	Check whether the DC input voltage is lower than 10.8/21.6/43.2V by a multi-meter. The inverter resumes work after adjusting the input voltage.
2	Green indicator fast flashes (1Hz) Red indicator turns OFF Buzzer beeps	The DC input voltage is too high.	Check whether the DC input voltage is higher than 16/32/64V by a multi-meter. The inverter resumes work after adjusting the input voltage
3	Green indicator is ON solid Red indicator slowly flashes (1/4Hz) Buzzer beeps	Overload	Check whether the AC load's power is within the inverter's rated power; clear the overload faults and restart the inverter.
4	Green indicator turns OFF Red indicator fast flashes (1Hz) Buzzer beeps	Load short-circuit	Check the load connection carefully. Clear the short circuit faults and restart the inverter.
5	Green indicator turns OFF Red indicator is ON solid. Buzzer beeps	Inverter over-temperature	Improve the ventilation situation and cool the surrounding temperature. It is recommended to restart the inverter after the temperature drops. If the fault cannot be cleared after performing the above operations, decline the rated power.



## 8 Maintenance

For good performance, the following inspections and maintenance tasks are recommended at least two times per year.

- Make sure no block on airflow around the inverter. Clear up any dirt and fragments on the heat sink.
- Check all the naked wires to ensure insulation is not damaged by sun exposure, frictional wear, dryness, insects or rats, etc.
- Verify the indicator display is consistent with the actual operation.
- Confirm that terminals have no corrosion, insulation damage, high temperature, burnt/discolored sign, and tighten terminal screws to the suggested torque.
- Clear up dirt, nesting insects, and corrosion in time.
- Check and confirm that the lightning arrester is in good condition. Replace a new one in time to avoid damaging the inverter and other equipment.



**WARNING**

Risk of electric shock! Confirm all the power is turned off and all the capacitor's energy has been discharged before performing the above operations.

## 9 Specifications

Instructions for the ① / ② / ③ marked in specifications table:

- ① Only the customized products with anti-surge function, the "Surge current when power on" is valid; other products, the actual surge current prevails.
- ② It means the rated output efficiency when the load power equals the continuous output power under the rated DC input voltage.
- ③ It means the max. output efficiency when the inverter is connected with different loads under the rated DC input voltage.

Parameter	IPT350-11	IPT350-21	IPT500-11	IPT500-21
Continuous output power	350W @35°C@Rated input voltage		500W @35°C@Rated input voltage	
Surge power	700W @5S		1000W @5S	
Surge current when power on <sup>①</sup>	< 30A		< 50A	
Output voltage	110VAC (±3%); 120VAC (-7%~+3%)			
Output frequency	50/60Hz ± 0.2%			
Output wave	Pure Sine Wave			
Output distortion THD	THD ≤ 4% (Resistive load)	THD ≤ 3% (Resistive load)	THD ≤ 4% (Resistive load)	
Load power factor	0.2 ~ 1 (Load power ≤ Continuous output power)			
Rated input voltage	12VDC	24VDC	12VDC	24VDC
Input voltage range	10.8 ~ 16.0VDC	21.6 ~ 32VDC	10.8 ~ 16.0VDC	21.6 ~ 32VDC
Rated output efficiency <sup>②</sup>	> 87.0%	> 90.0%	> 87.5%	> 90.0%
Max. output efficiency <sup>③</sup>	> 89.0% (70% loads)	> 90.5% (70% loads)	> 90.0% (40% loads)	> 91.0% (40% loads)
Idle current	< 0.2A		< 0.15A	< 0.10A

No-load current	< 0.8A	< 0.4A	< 0.8A	< 0.5A
RS485 com. port	5VDC/200mA			
<b>Mechanical parameters</b>				
Input terminal	M6		M6	
Dimension(L x W x H)	229 x 160 x 73mm		286 x 160 x 73mm	
Mounting size	205 x 75mm		262 x 75mm	
Mounting hole size	Φ5mm		Φ5mm	
Net Weight	1.5kg		2.3kg	

Parameter	IPT1000-11	IPT1000-21	IPT1500-11	IPT1500-21	IPT1500-41
Continuous output power	1000W @35°C @Rated input voltage		1500W @35°C @Rated input voltage		
Surge power	2000W @5S		3000W @5S		
Surge current when power on <sup>①</sup>	< 100A		< 100A	< 100A	< 50A
Output voltage	110VAC (±3%); 120VAC (-7%~+3%)				
Output frequency	50/60Hz ± 0.2%				
Output wave	Pure Sine Wave				
Output distortion THD	THD ≤ 4% (Resistive load)	THD ≤ 3% (Resistive load)	THD ≤ 4% (Resistive load)		
Load power factor	0.2 ~ 1 (Load power ≤ Continuous output power)				
Rated input voltage	12VDC	24VDC	12VDC	24VDC	48VDC
Input voltage range	10.8 ~ 16.0VDC	21.6 ~ 32.0VDC	10.8 ~ 16.0VDC	21.6 ~ 32.0VDC	43.2 ~ 64.0VDC
Rated output efficiency <sup>②</sup>	> 87.0%	> 90.0%	> 88.0%	> 88.0%	> 90.0%
Max. output efficiency <sup>③</sup>	> 92.0% (40% loads)	> 92.5% (30% loads)	> 93.0% (30% loads)	> 92.5% (30% loads)	> 92.0% (30% loads)
Idle current	< 0.2A	< 0.15A	< 0.2A	< 0.15A	< 0.1A

No-load current	< 0.8A	< 0.6A	< 1.0A	< 0.9A	< 0.5A
RS485 port	5VDC/200mA				
<b>Mechanical parameters</b>					
Input terminal	M6		M6		
Dimension (L x W x H)	371 x 228 x 118mm		387 x 228 x 118mm		
Mounting size	345 x 145mm		361 x 145mm		
Mounting hole size	Φ6mm		Φ6mm		
Net Weight	4.8kg		5.8kg		

Parameter	IPT2000-11	IPT2000-21	IPT2000-41
Continuous output power	2000W @35°C @Rated input voltage		
Surge power	4000W @5S		
Surge current when power on <sup>①</sup>	< 100A	< 100A	< 50A
Output voltage	110VAC (±3%); 120VAC (-7%~+3%)		
Output frequency	50/60Hz ± 0.2%		
Output wave	Pure Sine Wave		
Output distortion THD	THD ≤ 5% (Resistive load)	THD ≤ 4% (Resistive load)	THD ≤ 4% (Resistive load)
Load power factor	0.2 ~ 1 (Load power ≤ Continuous output power)		
Rated input voltage	12VDC	24VDC	48VDC
Input voltage range	10.8 ~ 16.0VDC	21.6 ~ 32.0VDC	43.2 ~ 64.0VDC
Rated output efficiency <sup>②</sup>	> 85.0%	> 88.0%	> 88.0%
Max. output efficiency <sup>③</sup>	> 92.0% (30% loads)	> 92.0% (30% loads)	> 93.0% (30% loads)
Idle current	< 0.2A	< 0.15A	< 0.1A
No-load current	< 1.2A	< 0.9A	< 0.5A

RS485 com. port	5VDC/200mA		
<b>Mechanical parameters</b>			
Input terminal	M10	M6	M6
Dimension (L x W x H)	420 x 228 x 118mm	421 x 228 x 118mm	
Mounting size	395 x 145mm	395 x 145mm	
Mounting hole size	Φ6mm	Φ6mm	
Net Weight	7.5kg	6.5kg	

Parameter	IPT3000-11	IPT3000-21	IPT3000-41	IPT4000-41
Continuous output power	3000W @35°C@Rated input voltage			4000W @35°C@Rated input voltage
Surge power	4800W@5S	6000W@5S	6000W@5S	8000W@5S
Surge current when power on <sup>①</sup>	< 100A	< 100A	< 65A	< 65A
Output voltage	110VAC (±3%); 120VAC (-7%~+3%)			
Output frequency	50/60Hz ± 0.2%			
Output wave	Pure Sine Wave			
Output distortion THD	THD ≤ 4% (Resistive load)	THD ≤ 5% (Resistive load)	THD ≤ 4% (Resistive load)	THD ≤ 4% (Resistive load)
Load power factor	0.2 ~ 1 (Load power ≤ Continuous output power)			
Rated input voltage	12VDC	24VDC	48VDC	48VDC
Input voltage range	10.8 ~ 16.0VDC	21.6 ~ 32.0VDC	43.2 ~ 64.0VDC	43.2 ~ 64.0VDC
Rated output efficiency <sup>②</sup>	> 85.0%	> 87.0%	> 89.5%	> 88.0%
Max. output efficiency <sup>③</sup>	> 93.0% (30% loads)	> 91.5% (30% loads)	> 93.5% (30% loads)	> 93.0%(30% loads)
Idle current	< 0.2A	< 0.15A	< 0.1A	< 0.1A
No-load current	< 1.6A	< 1A	< 0.4A	< 0.6A
RS485 com. port	5VDC/200mA			

<b>Mechanical parameters</b>				
Input terminal	M10	M6	M6	M6
Dimension (L x W x H)	550 x 270 x 143mm	521 x 270 x 143mm	516 x 228 x 118mm	521 x 270 x 143mm
Mounting size	525 x 145mm	495 x 145mm	490 x 145mm	495 x 145mm
Mounting hole size	Φ6mm	Φ6mm	Φ6mm	Φ6mm
Net Weight	13.0kg	9.0kg	7.5kg	12.0kg

<b>Parameter</b>	<b>IPT350-12</b>	<b>IPT350-22</b>	<b>IPT500-12</b>	<b>IPT500-22</b>
Continuous output power	350W@35°C@ Rated input voltage		500W@35°C@Rated input voltage	
Surge power	700W@5S		1000W@5S	
Surge current when power on <sup>①</sup>	< 30A		< 50A	
Output voltage	220VAC (±3%); 230VAC (-7%~+3%)			
Output frequency	50/60Hz ± 0.2%			
Output wave	Pure Sine Wave			
Output distortion THD	THD ≤ 3% (Resistive load)			
Load power factor	0.2 ~ 1 (Load power ≤ Continuous output power)			
Rated input voltage	12VDC	24VDC	12VDC	24VDC
Input voltage range	10.8 ~ 16.0VDC	21.6 ~ 32VDC	10.8 ~ 16.0VDC	21.6 ~ 32VDC
Rated output efficiency <sup>②</sup>	> 89.0%	> 90.0%	> 89.5%	> 91.5%
Max. output efficiency <sup>③</sup>	> 90.0% (70% loads)	> 91.5% (70% loads)	> 91.0% (40% loads)	> 92.0% (40% loads)
Idle current	< 0.15A	< 0.10A	< 0.15A	< 0.10A
No-load current	< 0.9A	< 0.4A	< 0.9A	< 0.6A
RS485 com. port	5VDC/200mA			

<b>Mechanical parameters</b>				
------------------------------	--	--	--	--

Input terminal	M6	M6
Dimension (L x W x H)	229 × 160 × 73mm	286 × 160 × 73mm
Mounting size	205 × 75mm	262 × 75mm
Mounting hole size	Φ5mm	Φ5mm
Net Weight	1.5kg	2.3kg

Parameter	IPT1000-12	IPT1000-22	IPT1500-12	IPT1500-22	IPT1500-42
Continuous output power	1000W @35°C @Rated input voltage		1500W @35°C @Rated input voltage		
Surge power	2000W @5S		3000W @5S		
Surge current when power on <sup>①</sup>	< 100A		< 100A	< 100A	< 50A
Output voltage	220VAC (±3%); 230VAC (-7%~+3%)				
Output frequency	50/60Hz ± 0.2%				
Output wave	Pure Sine Wave				
Output distortion THD	THD ≤ 3% (Resistive load)				
Load power factor	0.2 ~ 1 (Load power ≤ Continuous output power)				
Rated input voltage	12VDC	24VDC	12VDC	24VDC	48VDC
Input voltage range	10.8 ~ 16.0VDC	21.6 ~ 32.0VDC	10.8 ~ 16.0VDC	21.6 ~ 32.0VDC	43.2 ~ 64.0VDC
Rated output efficiency <sup>②</sup>	> 89.0%	> 90.0%	> 89.0%	> 90.0%	> 92.5%
Max. output efficiency <sup>③</sup>	> 93.0% (40% loads)	> 93.0% (30% loads)	> 93.0% (30% loads)	> 93.5% (30% loads)	> 94.0% (30% loads)
Idle current	< 0.2A	< 0.15A	< 0.2A	< 0.15A	< 0.1A
No-load current	< 1.1A	< 0.9A	< 1.2A	< 0.9A	< 0.5A
RS485 com. port	5VDC/200mA				
<b>Mechanical parameters</b>					
Input terminal	M6		M6		
Dimension (L x W x H)	371 × 228 × 118mm		387 × 228 × 118mm		

Mounting size	345 x 145mm	361 x 145mm
Mounting hole size	Φ6mm	Φ6mm
Net Weight	4.8kg	5.8kg

Parameter	IPT2000-12	IPT2000-22	IPT2000-42
Continuous output power	2000W @35°C @Rated input voltage		
Surge power	4000W @5S		
Surge current when power on <sup>①</sup>	< 100A	< 100A	< 50A
Output voltage	220VAC (±3%); 230VAC (-7%~+3%)		
Output frequency	50/60Hz ± 0.2%		
Output wave	Pure Sine Wave		
Output distortion THD	THD ≤ 3% (Resistive load)		
Load power factor	0.2 ~ 1 (Load power ≤ Continuous output power)		
Rated input voltage	12VDC	24VDC	48VDC
Input voltage range	10.8 ~ 16.0VDC	21.6 ~ 32.0VDC	43.2 ~ 64.0VDC
Rated output efficiency <sup>②</sup>	> 88.0%	> 90.0%	> 92.5%
Max. output efficiency <sup>③</sup>	> 94.0% (30% loads)	> 93.0% (30% loads)	> 94.5% (30% loads)
Idle current	< 0.2A	< 0.15A	< 0.1A
No-load current	< 1.2A	< 1.0A	< 0.5A
RS485 com. port	5VDC/200mA		
<b>Mechanical parameters</b>			
Input terminal	M10	M6	M6
Dimension (L x W x H)	420 x 228 x 118mm	421 x 228 x 118mm	421 x 228 x 118mm
Mounting size	395 x 145mm	395 x 145mm	395 x 145mm
Mounting hole size	Φ6mm	Φ6mm	Φ6mm



Net Weight	7.8kg	6.5kg	6.5kg
------------	-------	-------	-------

Parameter	IPT3000-12	IPT3000-22	IPT3000-42	IPT4000-42	IPT5000-42
Continuous output power	3000W @35°C @Rated input voltage			4000W @35°C @Rated input voltage	5000W @35°C @Rated input voltage
Surge power	6000W @5S			8000W @5S	
Surge current when power on <sup>①</sup>	< 100A	< 100A	< 65A	< 65A	
Output voltage	220VAC (±3%); 230VAC (-7%~+3%)				
Output frequency	50/60Hz ± 0.2%				
Output wave	Pure Sine Wave				
Output distortion THD	THD ≤ 3% (Resistive load)				
Load power factor	0.2 ~ 1 (Load power ≤ Continuous output power)				
Rated input voltage	12VDC	24VDC	48VDC	48VDC	
Input voltage range	10.8 ~ 16.0VDC	21.6 ~ 32.0VDC	43.2 ~ 64.0VDC	43.2 ~ 64.0VDC	
Rated output efficiency <sup>②</sup>	> 87.0%	> 90.0%	> 92.5%	> 91.0%	
Max. output efficiency <sup>③</sup>	> 94.0% (30% loads)	> 94.0% (30% loads)	> 94.5% (30% loads)	> 94.0%(30% loads)	
Idle current	< 0.2A	< 0.15A	< 0.1A	< 0.1A	< 0.1A
No-load current	< 1.6A	< 1.0A	< 0.5A	< 0.6A	< 0.8A
RS485 com. port	5VDC/200mA				
Mechanical parameters					
Input terminal	M10	M6	M6	M6	M6
Dimension (L x W x H)	557 x 228 x 118mm	521 x 270 x 143mm	491 x 228 x 118mm	516 x 228 x 118mm	531 x 228 x 118mm
Mounting size	532 x 145mm	495 x 145mm	465 x 145mm	490 x 145mm	505 x 145mm
Mounting hole size	Φ6mm	Φ6mm	Φ6mm	Φ6mm	Φ6mm
Net Weight	10.0kg	8.5kg	7.0kg	8.0kg	9.0kg

**Environment parameters**

Working temperature	-20°C ~ +60°C (Refer to the Derating Curve)
Storage temperature	-35 °C ~ +70 °C
Relative humidity	≤ 95% (N.C.)
Enclosure	IP20
Altitude	< 5000m (If the altitude exceeds 1000 meters, the rated power will be reduced according to IEC62040.)

## Appendix 1 Disclaimers

**The warranty does not apply to the following conditions:**

- Damage caused by improper use or inappropriate environment.
- Load current/voltage/power exceeds the limit value of the inverter.
- Damage caused by working temperature exceeds the rated range.
- Arc, fire, explosion, and other accidents caused by failure to follow the inverter stickers or manual instructions.
- Disassemble and repair the inverter without authorization.
- Damage caused by force majeure.
- Damage occurred during transportation or handling.

**Any changes without prior notice!** Version number: V1.1

**HUIZHOU EPEVER TECHNOLOGY CO., LTD.**

**Beijing Tel: +86-10-82894896/82894112**

**Huizhou Tel: +86-752-3889706**

**E-mail: [info@epever.com](mailto:info@epever.com)**

**Website: [www.epever.com](http://www.epever.com)**