

BACH KIT

INSTALLATION MANUAL



GRIDFREE

BACH KIT



All wiring and voltages in this kit installation are well under the 120V DC standards for extra-low voltage (ELV). ELV is an electricity supply voltage in a range which carries a very low risk of electrical shock.



Installation of this kit does not require an electrician, however we recommend seeking help if at any stage you are not confident in your ability.

We are always happy to help guide you through the install, troubleshoot, and answer any questions. You can contact us on 09 218 5533, or info@gridfree.store.

We recommend reading these instructions in full prior to starting your install.

KIT CONTENTS

25mm² Cable 3m Pre-Crimped (Red+Black)



16mm² Cable (Black) 3m Pre-Crimped (Red+Black)



6mm² Solar PV Cable pair 10m - MC4 (Female, Red + Male, Black)



3x 50mm² Battery Link Cable (Blue)



MC4 Solar Adapter Y Branch Connector Set



2x PV Inline Fuse





The "C" label is the same as the Amp "A" label of the breaker.

32A DC
Circuit Breaker



63A DC
Circuit Breaker



125A DC
Circuit Breaker



HT-8 MCB Enclosure



60A MPPT Charge Controller (6415AN)



IPT 3000W Pure Sine Wave Inverter



4x 12v200Ah Deep Cycle Gel Battery



4x 330W+ PERC MONO Solar Panel

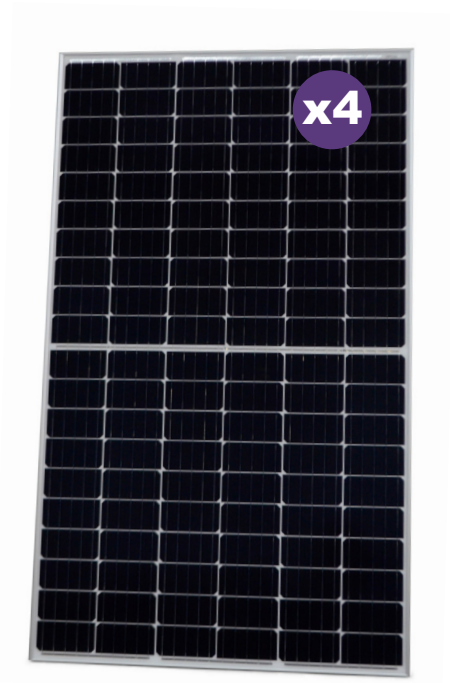

REQUIRED TOOLS

Drill



Screw Drivers

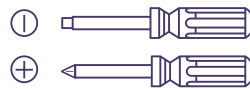

6mm Allen Key



Wire Strippers

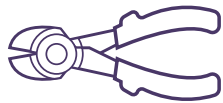

13mm Spanner



Socket Set



SOLAR MOUNTS

Ground



Tilt

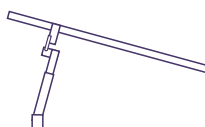

Corrugated



L-Feet



WIRING OVERVIEW

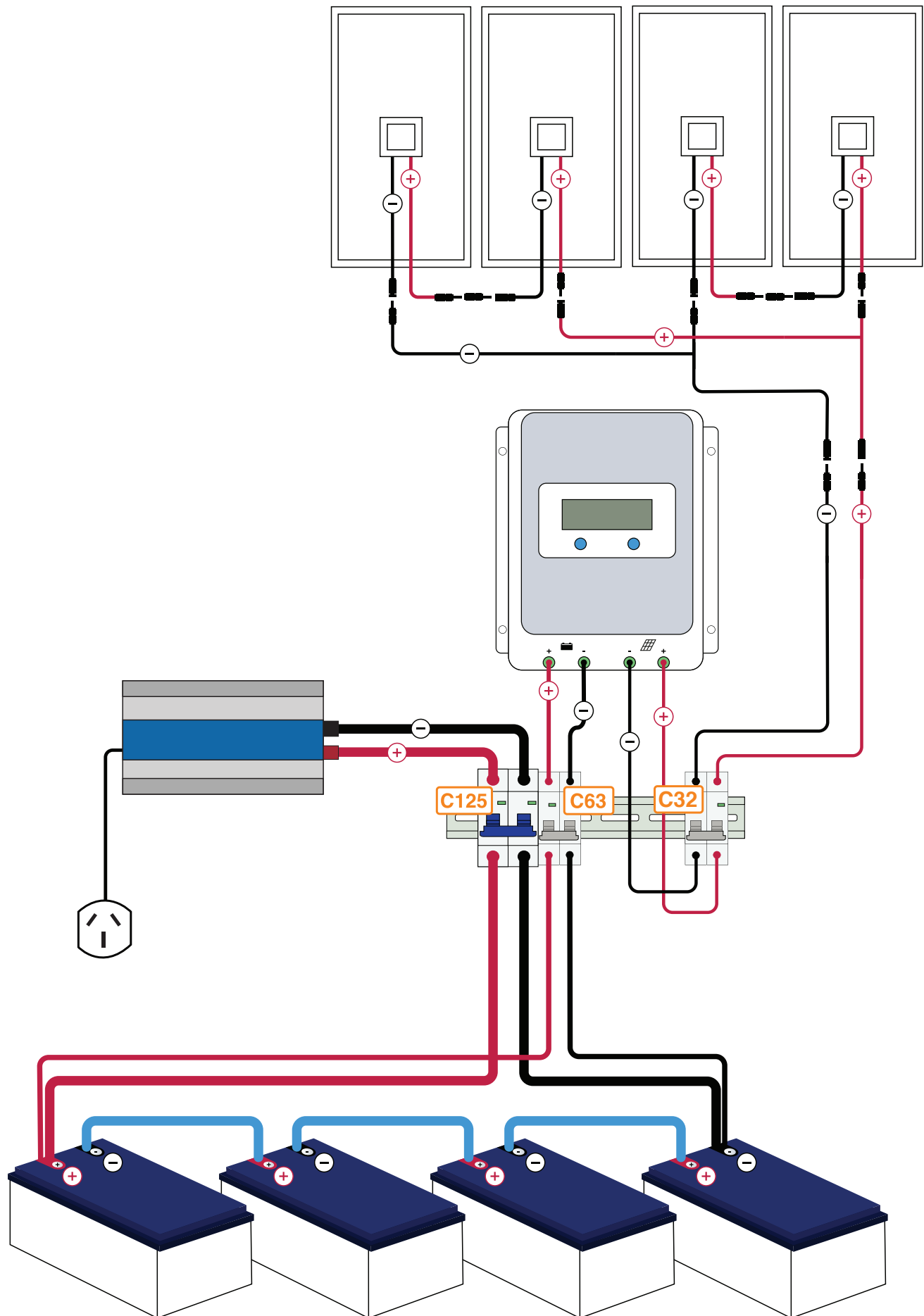

SOLAR PANEL WIRING

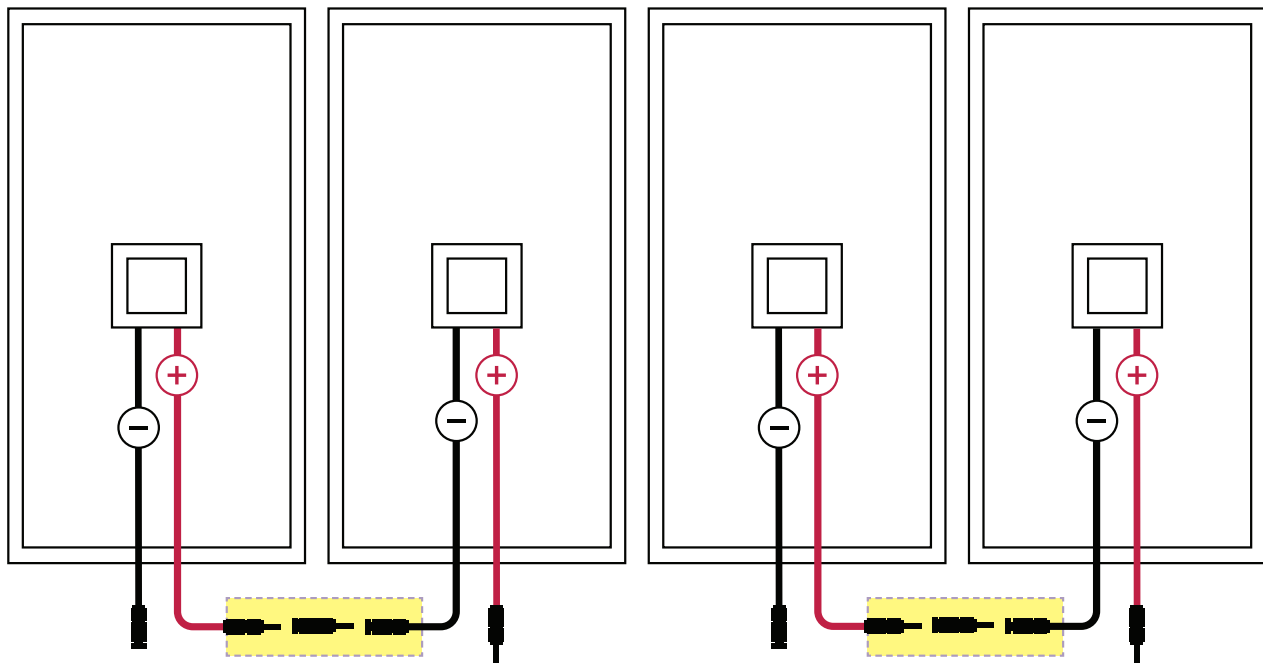
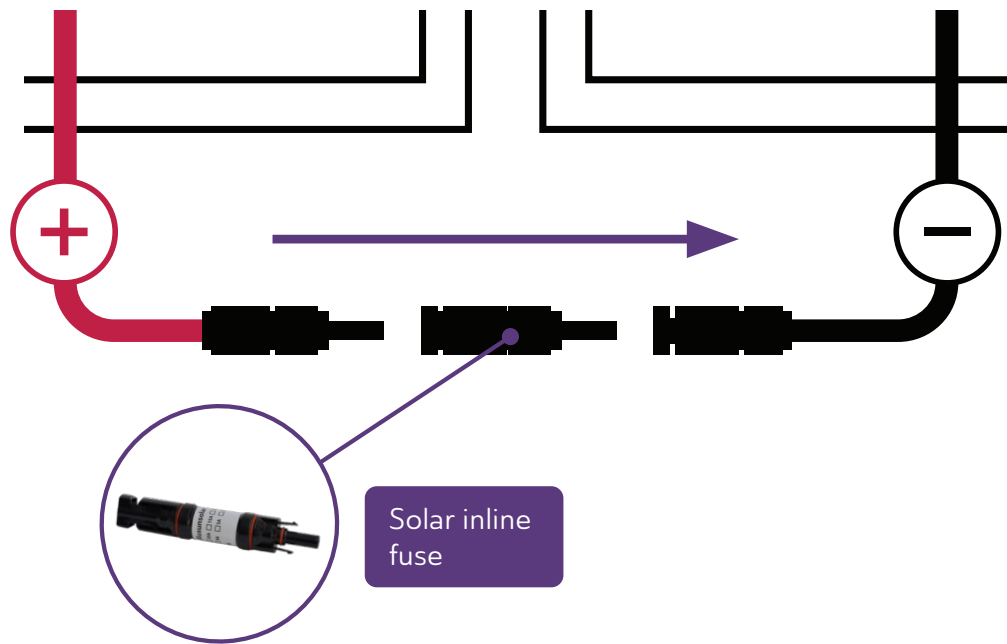

-
- 1 Wire the panels together in pairs by connecting the positive terminal of one panel to the inline fuse, then to the negative terminal of the next panel. This creates two pairs of panels in series.
-

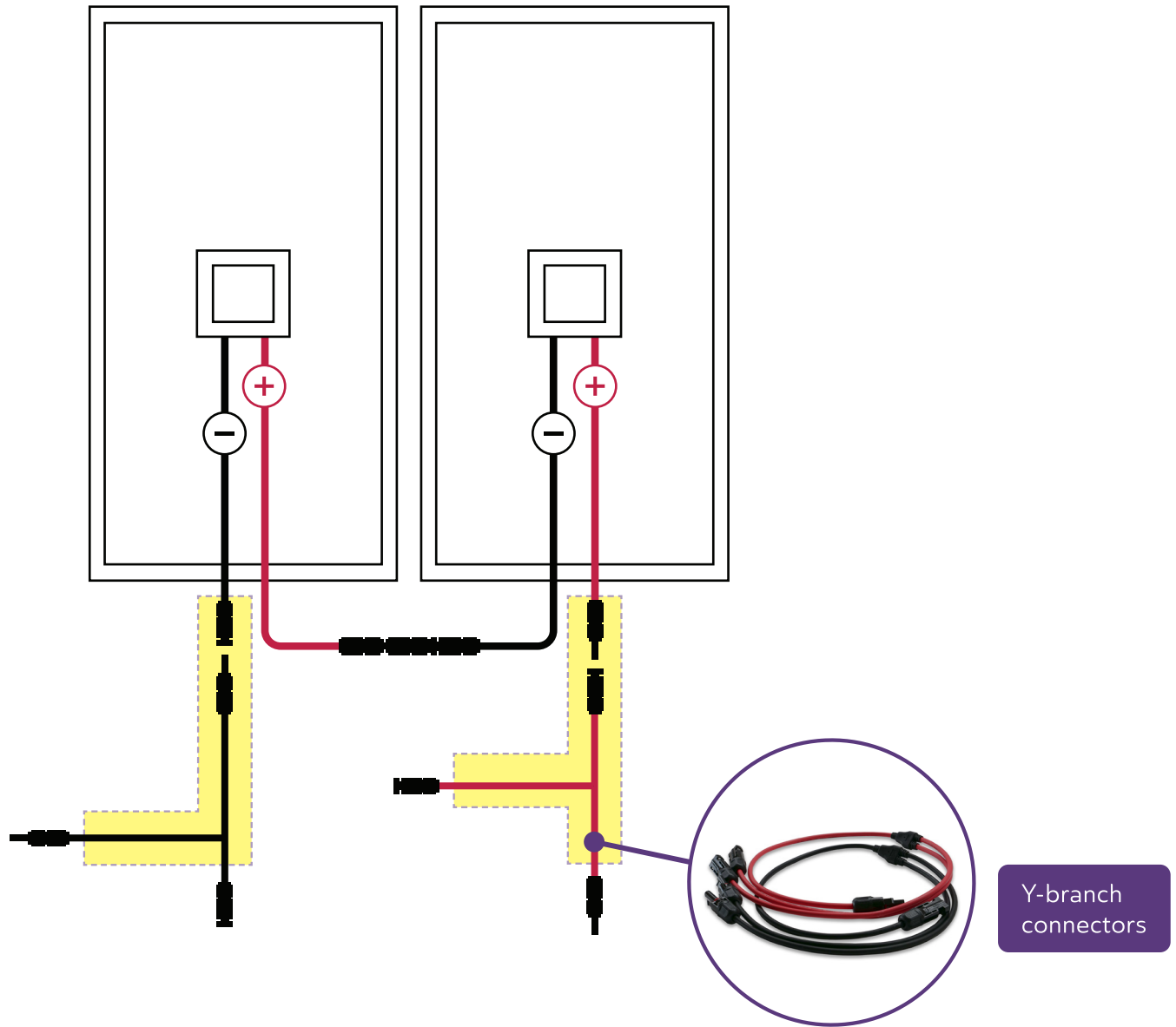

- 2 Connect the Y-branch connectors to one of the solar panel pairs.

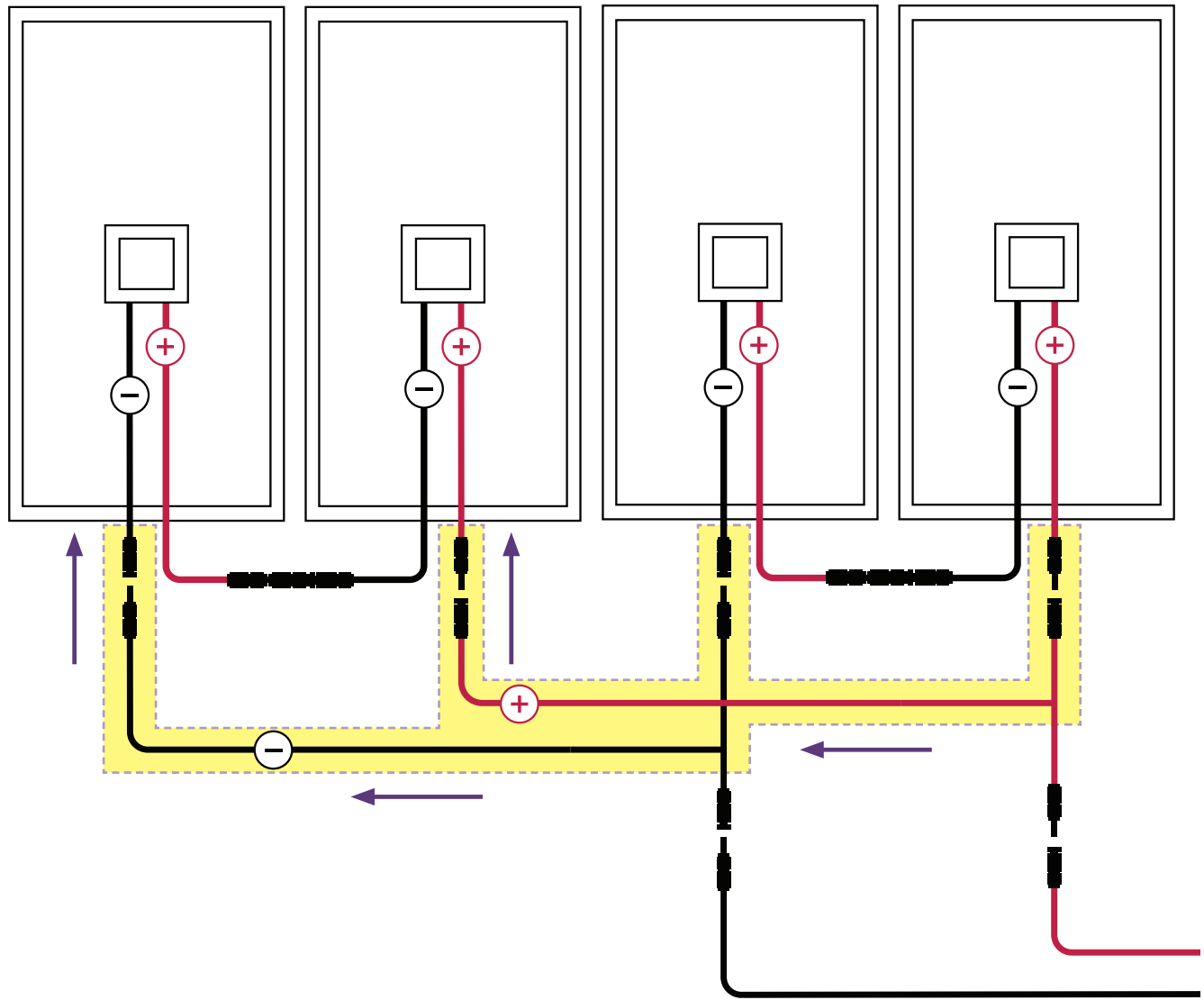

- 3 Connect the other pair of solar panels to the Y-branch connectors, connecting the negative terminals from each pair with the black Y-branch connector, and the positive terminals from each pair with the red.

This creates two outputs from the solar array, one positive (+), one negative (-).

SOLAR PANEL WIRING

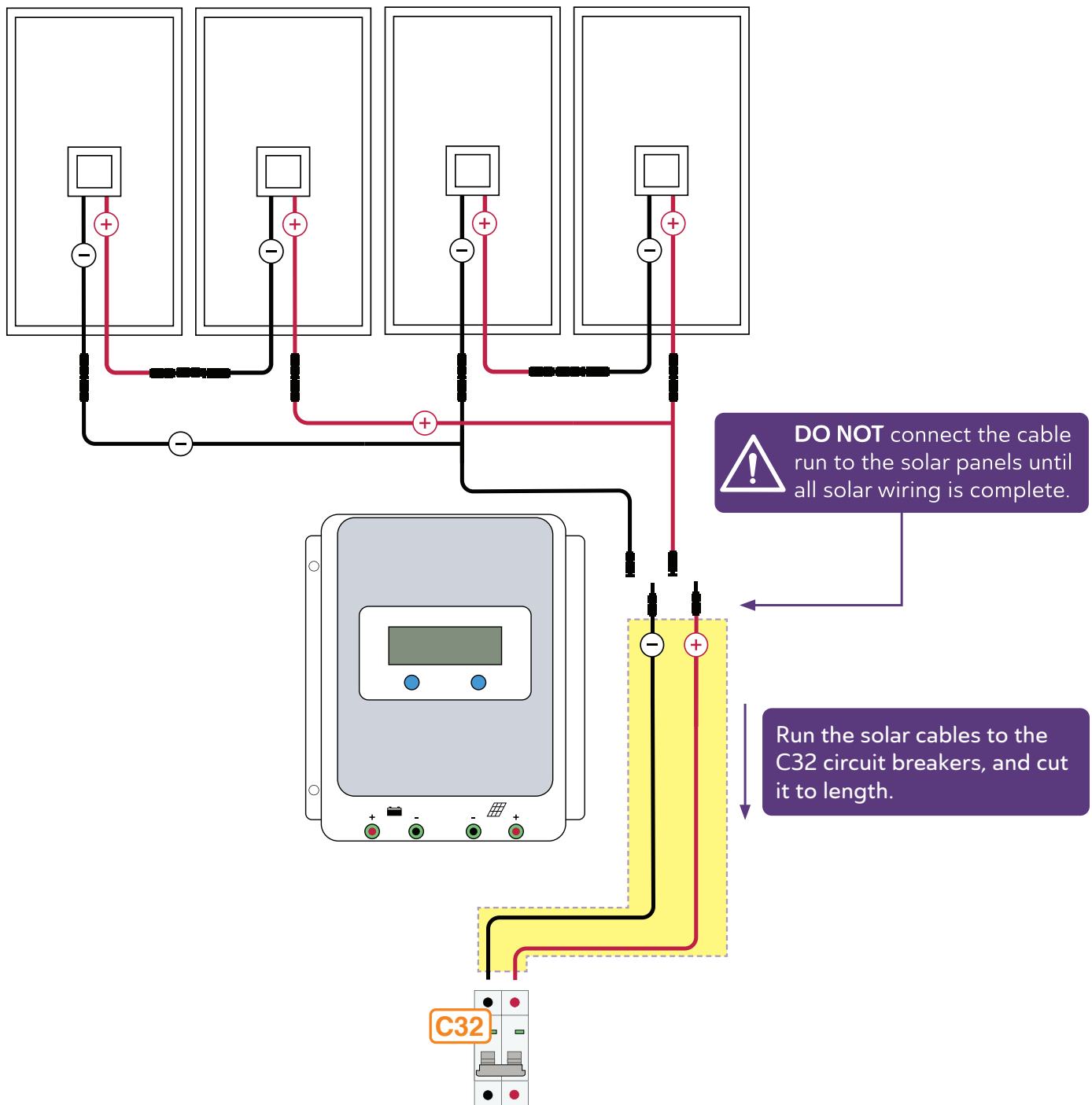

- 4 Run the 6mm solar cables from the solar panels back to the C32 circuit breakers, and cut it to length.



DO NOT connect the cable run to the solar panels yet, as the cables will become live. Wait until all solar wiring is complete.

Note: We recommend the PV cable to be run inside of a conduit when the cable is run across a roof, floor, or the interior of a building.

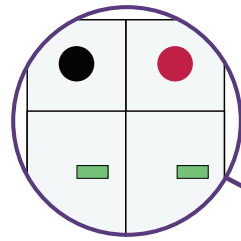

Indicator is green, showing the circuit breakers are switched off.

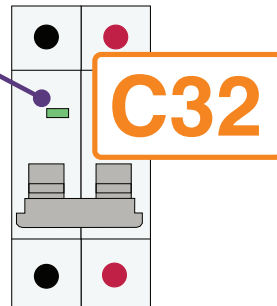

 Ensure the solar cable run is **NOT** connected to the solar panels, and the circuit breakers are switched off (showing green, switch down).

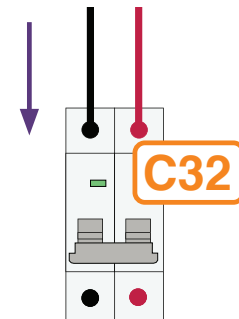
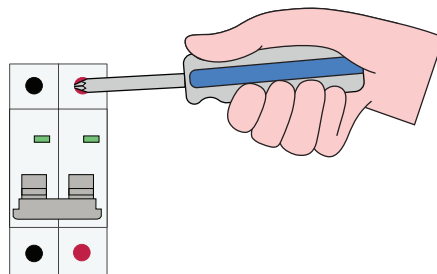
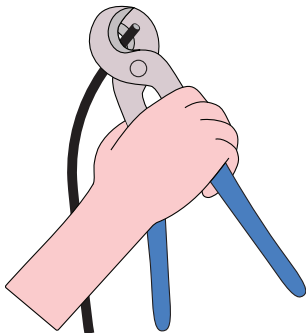

- 5 Use wire strippers to strip the ends of the solar cable, and terminate them in the circuit breaker by inserting the stripped end and tightening the screw clockwise. Make sure the clamp inside the circuit breaker is contacting the metal conductor, and **NOT** the insulation of the wire.

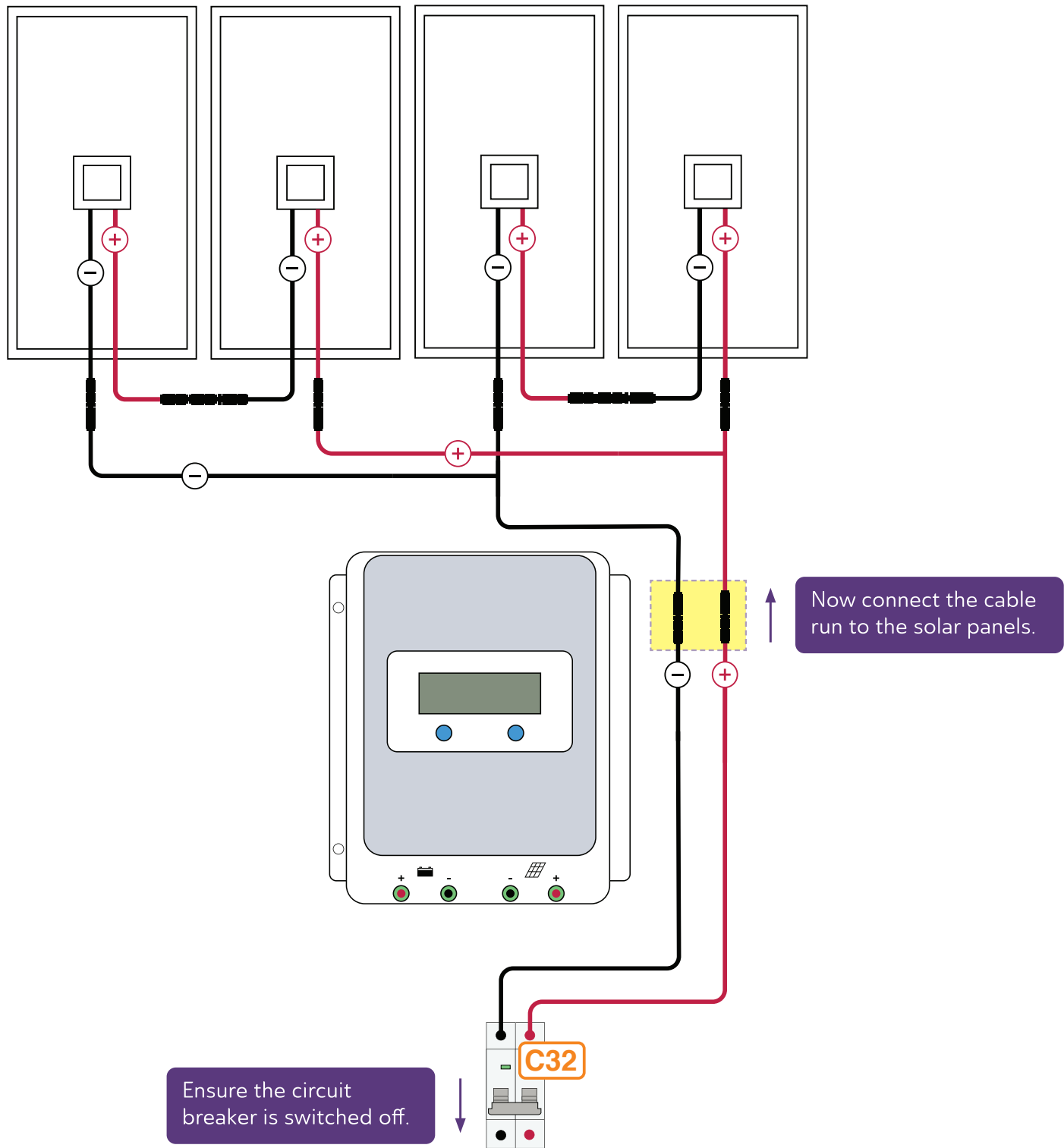

- 6 When the cables have been terminated in the circuit breaker, and the circuit breaker is switched off, you can now connect the solar panels to the cable run. The circuit breaker must be switched off when connecting or disconnecting the solar panels from the cable run.

For your safety do not connect or disconnect any solar cables when there is current running through them.

CHARGE CONTROLLER & INVERTER WIRING

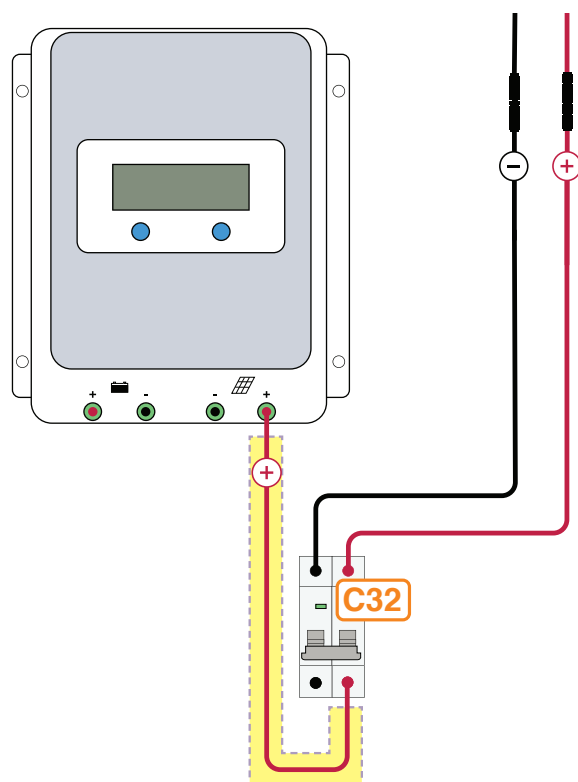

-
- 7** Wire the positive (+) 6mm cable from the charge controller to the C32 circuit breaker.
-

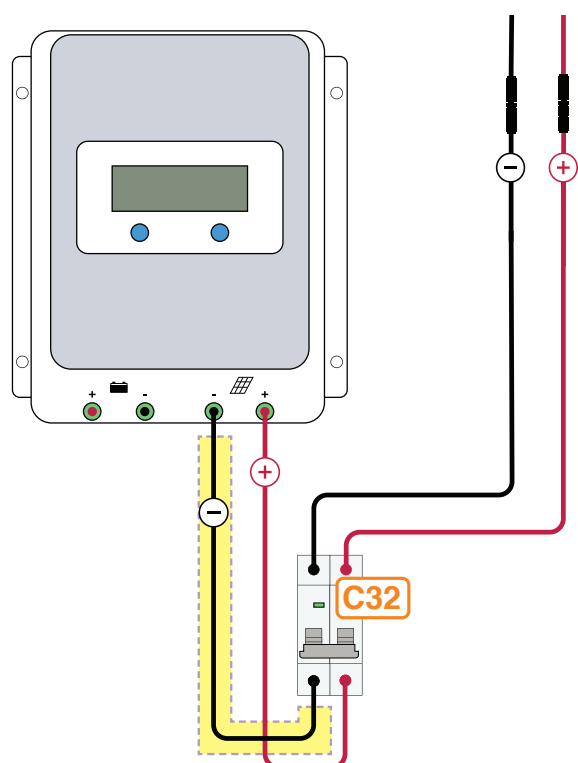

-
- 8** Wire the negative (-) 6mm cable from the charge controller to the C32 circuit breaker.
-

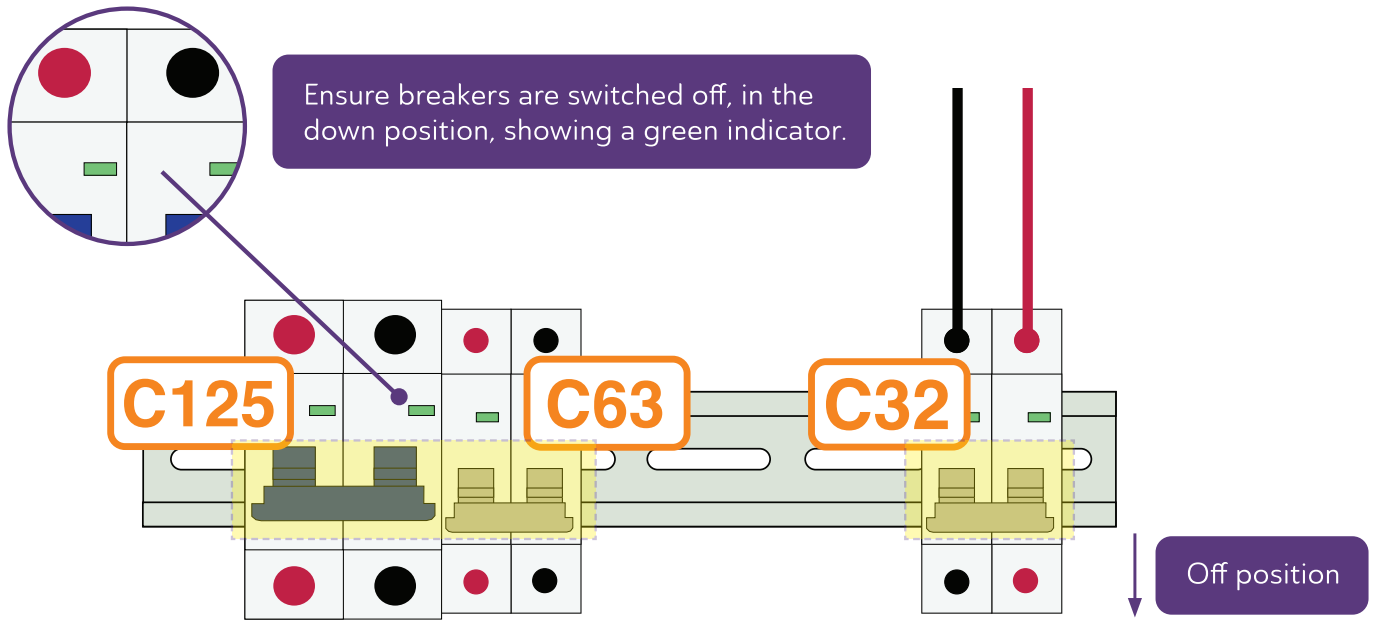

- 9 Ensure all circuit breakers are switched off (switch in the down position, indicator showing green) before wiring.

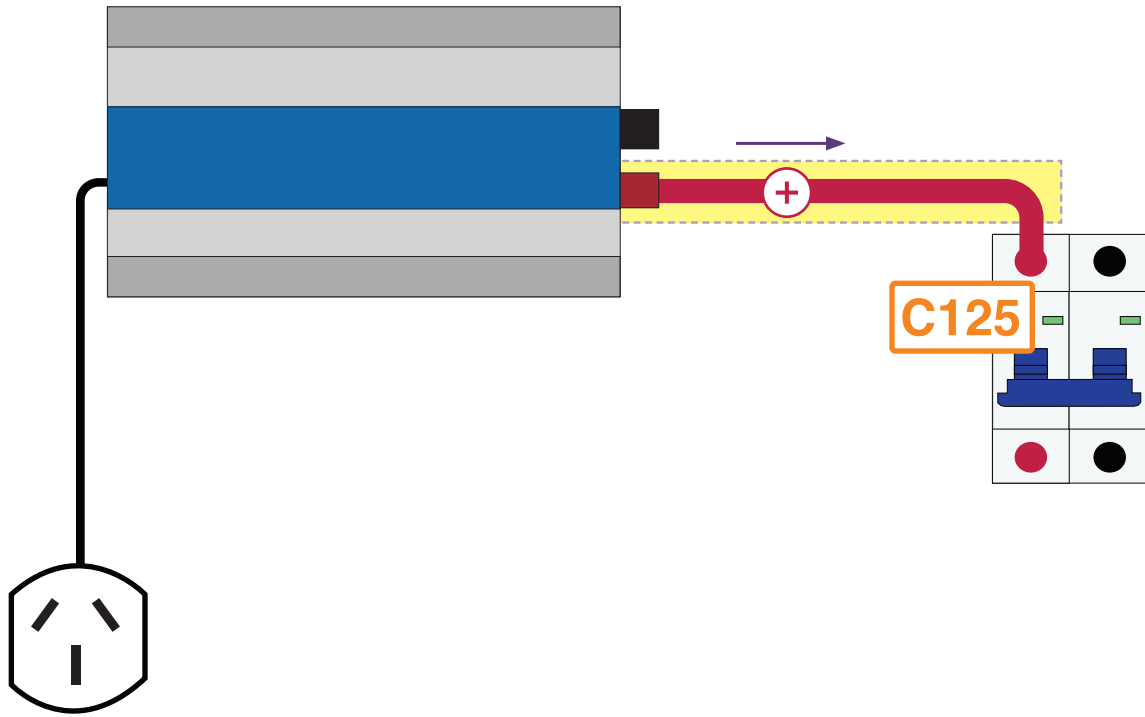

-
- 10** Wire the positive (+) 25mm cable from the inverter to the C125 circuit breaker.
-

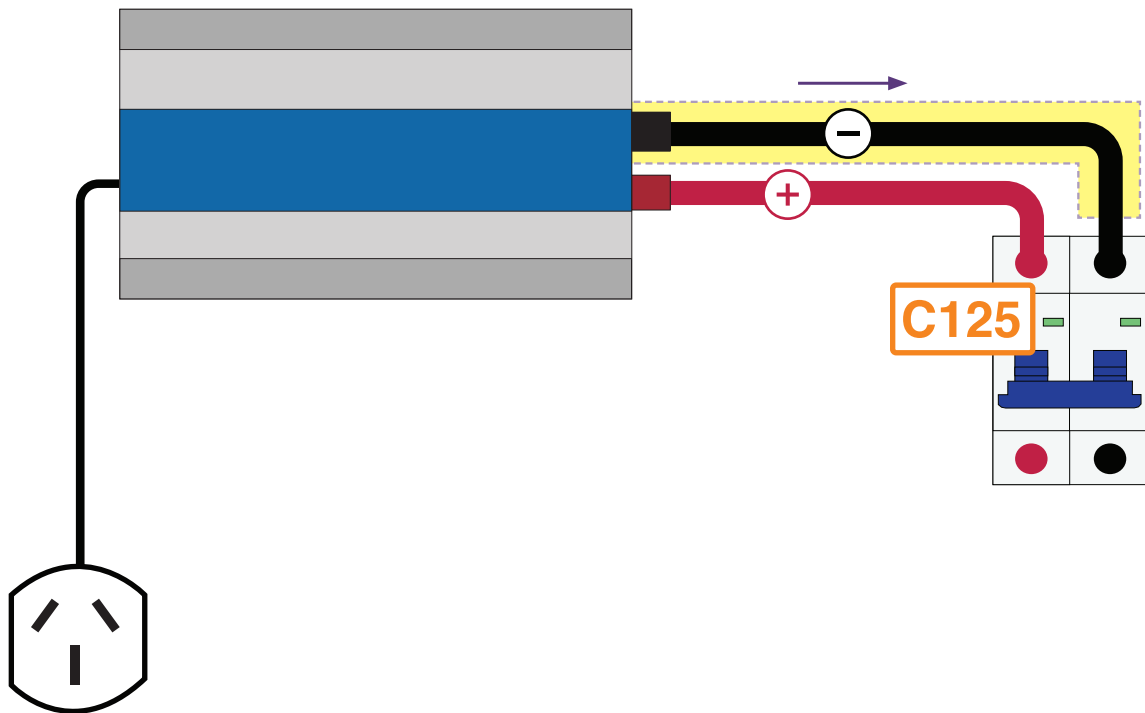

-
- 11** Wire the negative (-) 25mm cable from the inverter to the C125 circuit breaker.
-

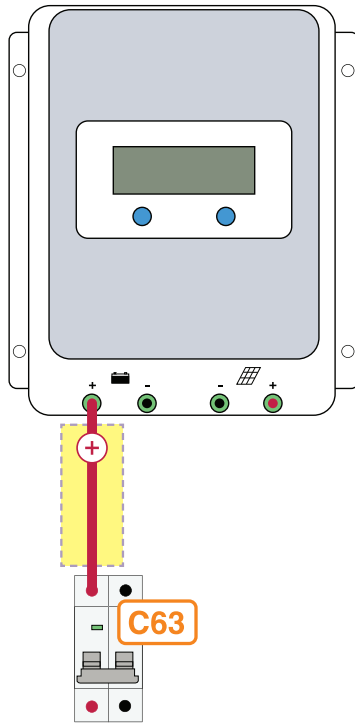

-
- 12** Wire the positive (+) 16mm cable from the charge controller to C63 circuit breaker.
-

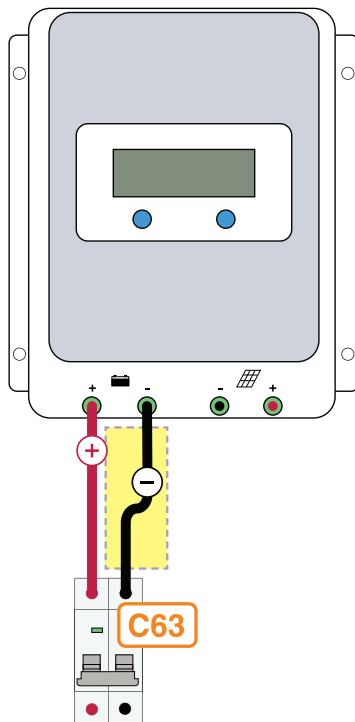

-
- 13** Wire the negative (-) 16mm cable from the charge controller to C63 circuit breaker.
-

BATTERY BANK SETUP AND WIRING

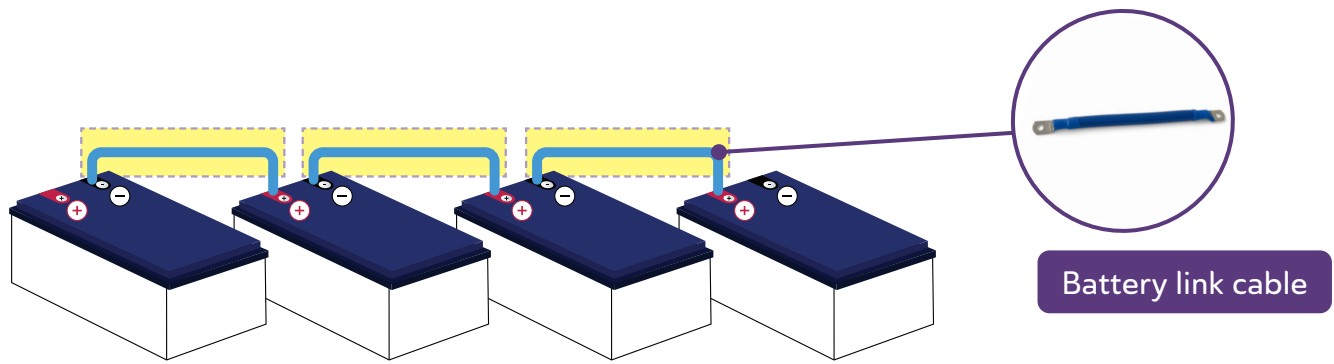

- 14 The battery bank is wired with four 12V batteries in series, this creates a 48V battery bank. The large gauge cable is used to connect the batteries together and used to connect to the inverter.

Wire the four batteries together with the blue battery link cables, from negative to positive.



When wiring the blue cables ensure that you fully attach each cable at both ends before moving onto the next.

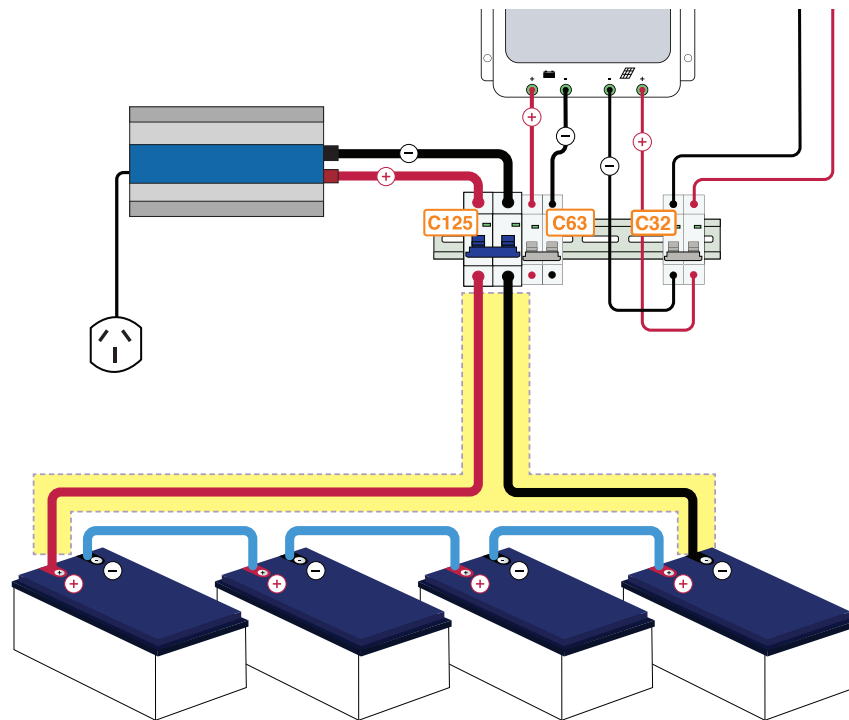

- 15 Wire the remaining set of red and black 25mm cable to the inverter through the C125 circuit breaker.



When running the wires from the battery bank to the circuit breaker, be very careful not to touch the positive (+) to the negative (-). This will cause a short circuit, which will result in a spark, and may damage the batteries or the cables.

We recommend only running one cable at a time (positives first, then negatives) to minimise risk.

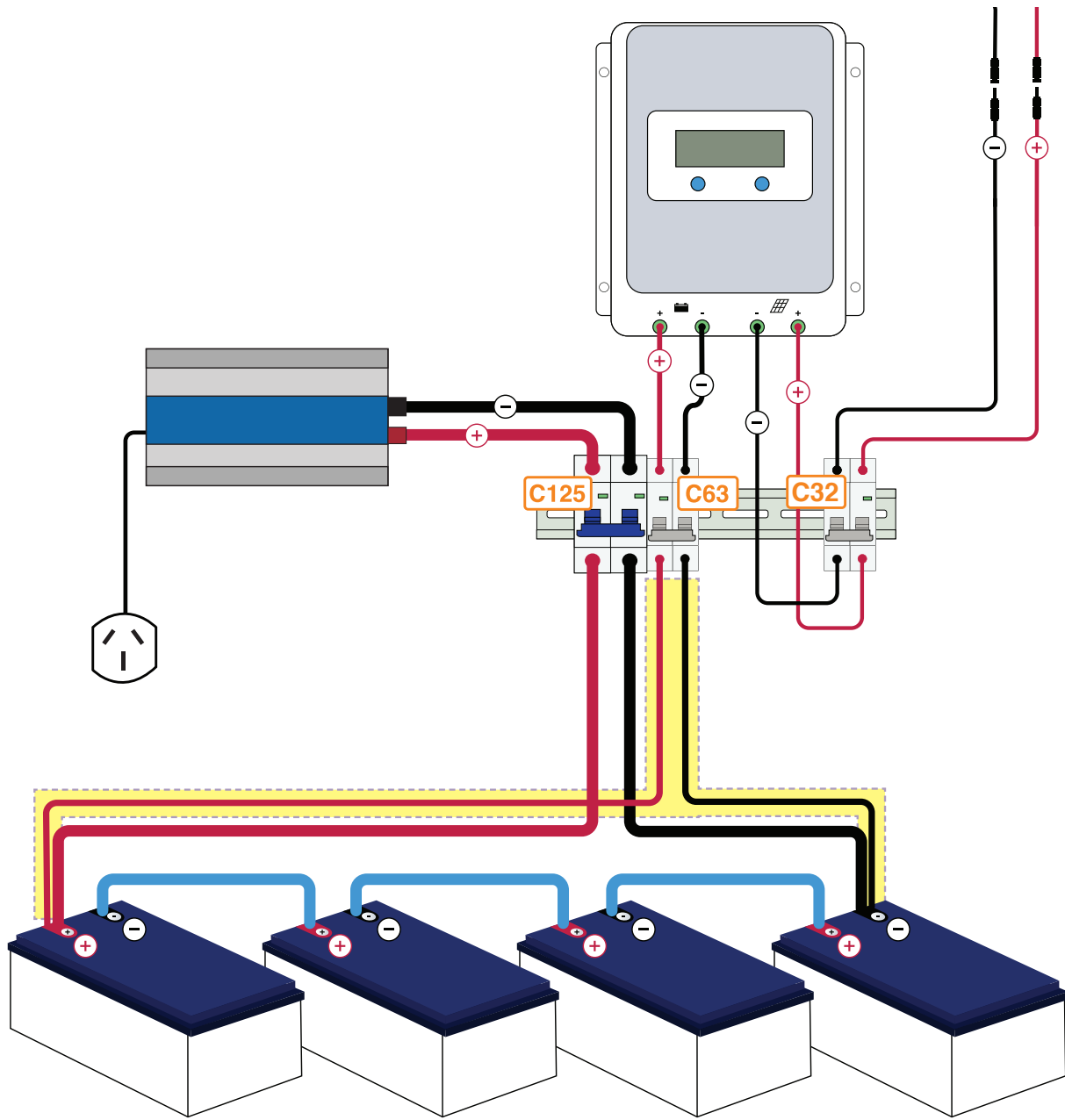

- 16** Wire the remaining set of red and black 16mm cable to the charge controller through the C63 circuit breaker.

START UP PROCEDURE

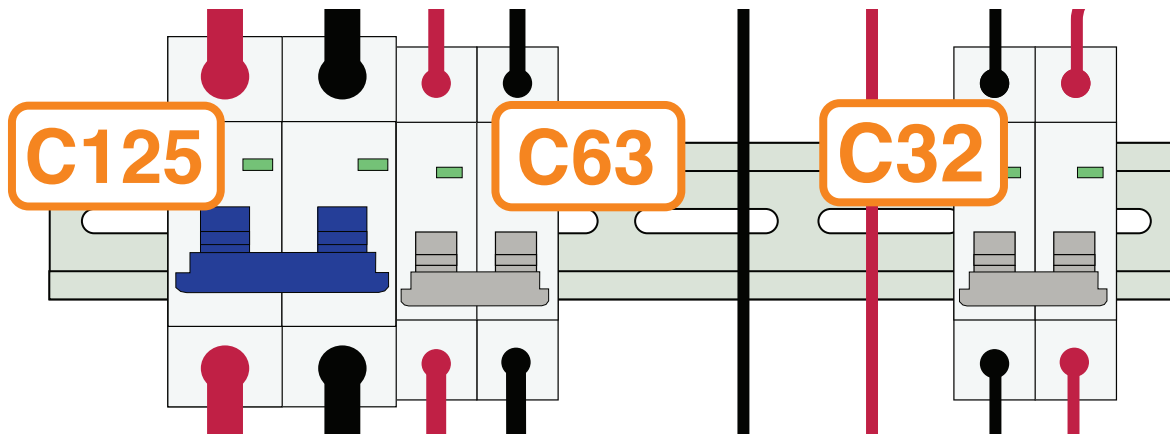

- 17 Switch on the circuit breakers in the following order. First switch on the battery to charge controller breaker C63. Then the battery to inverter C125. Finally, the panels to the charge controller C32.
-

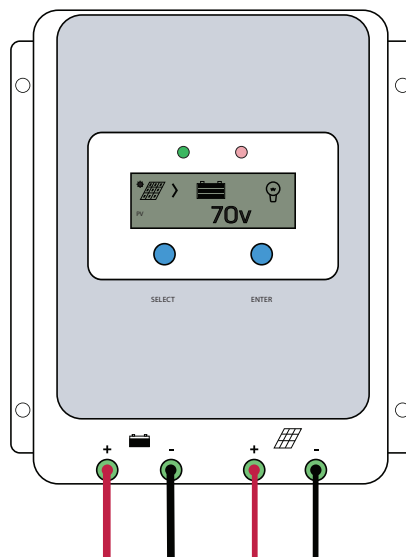

- 18 The Green LED on the charge controller should flash, and the panel voltage should be around 65V-70V in full sunlight. As this charge controller auto-detects voltage, on its first start up it can sometimes default to 12V, and will give a battery over voltage warning.

To fix this, switch off all circuit breakers in the reverse order of step 17. Then switch them back on.

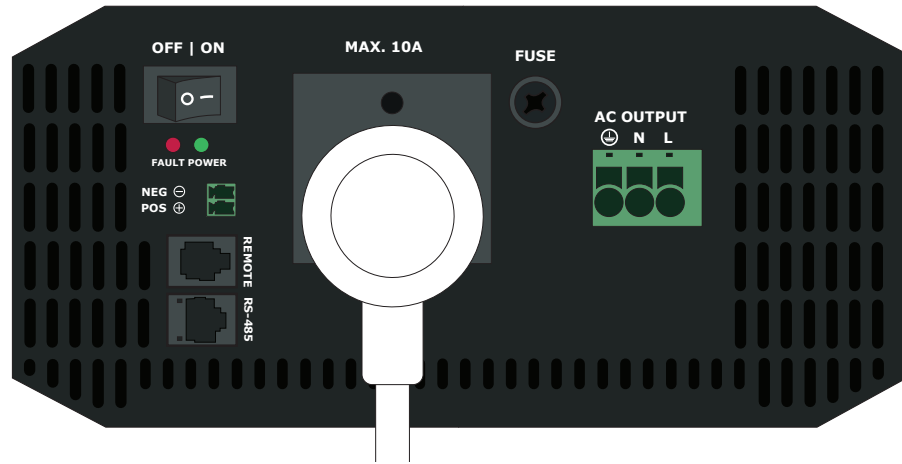

-
- 19 Flick the “ON” switch located on the side of the inverter, and check that all three LED indicators show green. If any do not show green, consult the inverter manual to identify the fault.
-

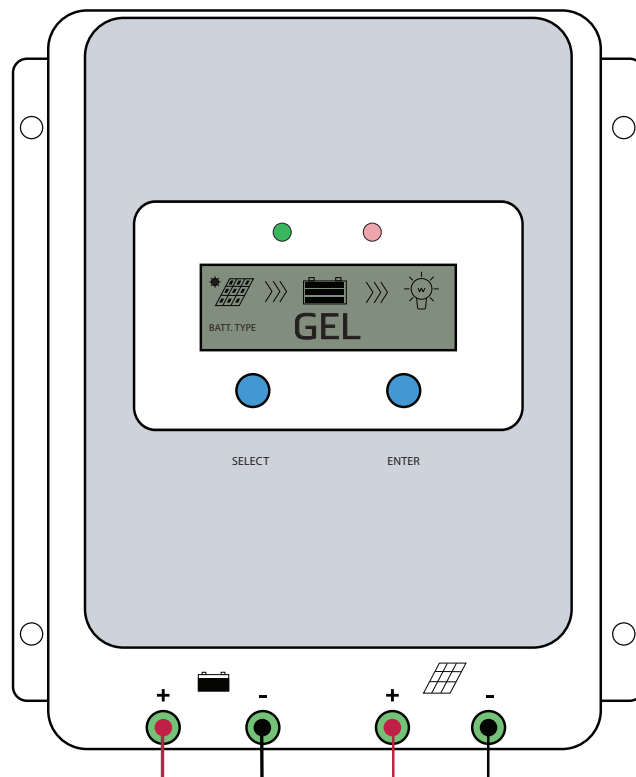

-
- 20 The system is now fully functional. The last step is to select the GEL battery charging mode on the charge controller. Click SELECT until the battery voltage interface is shown.

Hold down ENTER for 3 seconds, then click SELECT until the GEL word is displayed, then press ENTER.

GETTING THE MOST OUT OF YOUR KIT

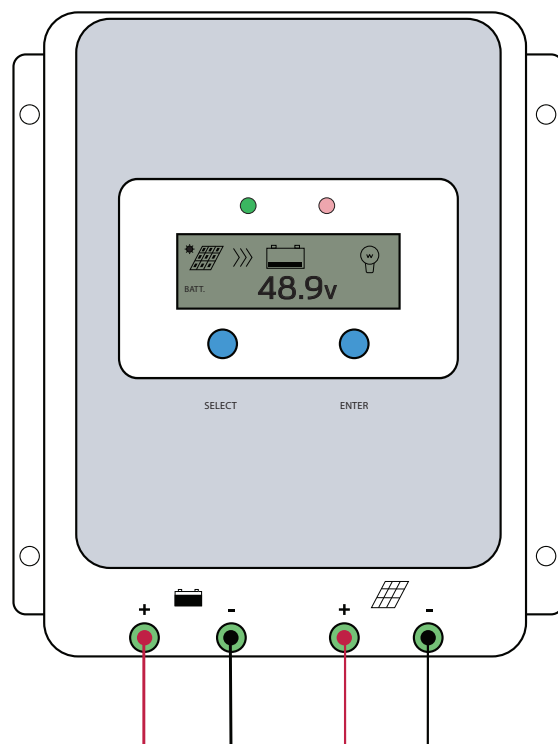

To get the most life out of your batteries they should not be discharged lower than 50%.

You can check the state of charge of the batteries on the charge controller. Make sure the charge controller is on this screen pictured above by pressing the SELECT button. The screen will display BATT on the left-hand side.

The charge controller displays the battery level in terms of voltage.

We have included this handy table that helps you convert from battery voltage to battery percentage.

The voltage will be higher than 51V when there is charge coming in from the solar panels. So if the battery voltage is showing as higher than 51V and there is less than 5 amps going into the batteries, the batteries will be at 100% charge.

Charge	Voltage
100%	51V - 60V
90%	50.5V
80%	50V
70%	49.5V
60%	49V
50%	48.5V
40%	48V
30%	47V
20%	46V
10%	45V

WHAT DIFFERENT CC SCREENS MEAN

Solar Panel Voltage

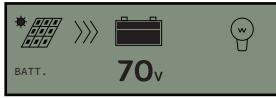

This shows the voltage of the solar panel array, for this kit it should show between 60V and 75V. During sunny days, the voltage will be higher than cloudy days.

Solar Panel Charge Current



This screen shows the current coming from the solar panels. This will read between 0 and 50A. When it is cloudy, or the batteries are fully charged, this number will be low.

Total Power Generated

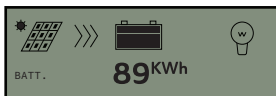

This screen shows the total power generated by the system since the last time it was turned on.

Battery Voltage

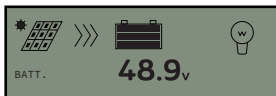

This is one of the most important screens, and shows the voltage of the battery bank. Refer to the Battery Voltage to State of Charge conversion table to use this number to determine how much charge is in the batteries.

Battery Charge Current



This is the next most important screen. This shows how much charge is going into the batteries. If the batteries are discharged and there is a lot of sun this number should be high. If the batteries are fully charged it is normal for this number to be close to zero.

Remote Temperature



If a remote temperature sensor is installed, this screen will show the temperature reading.

BATTERY CARE INFORMATION

What is Battery Cycle Life and Depth of Discharge?

Depth of Discharge is how much energy is discharged from the battery before it is charged to 100% again. A common measurement is battery cycle life, at 50% D.O.D (Depth of Discharge). At 50% DOD the battery has 50% of its energy capacity discharged, before it begins charging again.

This is common in a solar situation where during the day the sun charges the battery, then during the rest of the day, the energy stored in the battery is used to power appliances. Cycle life measures how many cycles down to 50% it takes before the battery capacity is reduced to 60% of its capacity when brand new.

Do I need to add water to my battery?

No. Sealed lead acid batteries do not require additional water to maintain them.

What should I avoid when charging batteries?

1. Avoid mixing batteries of different size and age – you will always be limited to the weakest battery in the string. For optimum performance, you should be using matched cells.
2. Don't run devices off just one battery to get 12V. Use a 48V to 12V step down. This ensures that the current is shared equally between the batteries so that they are all put under equal stress so they all have the same lifespan.
3. Never go lower than 50% depth of discharge (or 48.4V) - not only will this permanently damage your battery, but it will void your warranty.
4. Always charge your batteries to 100% - leaving them partially charged will lead to sulfation and reduce your battery's capacity.
5. Don't let your batteries get too cold or too hot – about 20°C is an ideal temperature, and for best results, aim to keep them between 10°C to 30°C

What happens if I over-discharge batteries?

OVER-DISCHARGING is a problem caused by insufficient battery capacity resulting in the batteries being overworked. Discharges deeper than 50% (below 48.4V) significantly shorten the Cycle Life of a battery. Infrequent or inadequate recharging can also cause rapid sulfation – a buildup of lead sulfate crystals covering the battery plates.

This coverage deteriorates the overall efficiency and power storage capability of the battery, meaning over-discharging will result in a loss of battery capacity. It will also void your warranty.

How can you check a battery's performance?

As a battery gets older, it will not have the same amount of capacity it had when it was brand new. To test the capacity of the battery, you will need to discharge the battery using a constant draw. By knowing how much current is being drawn, measuring the voltage at the beginning and at the end of the test, and timing the test, you can calculate the battery's capacity. This can be a complex test, and should only be done if you suspect the batteries are failing.

TROUBLESHOOTING GUIDE

We've compiled this list of common problems our customers may encounter with their solar gear to help you solve any issues as fast as possible.

If you don't find the answers you need here, or your issue continues after implementing the given solution, please get in touch.

1. My solar panels are not putting out as much power as normal

Once you've determined the drop in power is not due to weather changes, check your panels for any shade or shadows.

Check both morning and afternoon in case the shadows are inconsistent. Make sure they're cleaned off, as things such as thick dust or bird droppings can affect your output. Finally, double check all your connections are clean and secure.

If none of these issues are causing your power drop, you'll need to send us some clear pictures of your charge controller readings.

We need to see the battery voltage, solar panel voltage, and solar panel amps. Please send readings from the middle of the day with peak sun, as well as the end of the day or early morning.

2. My inverter keeps shutting off

Check your battery voltage, as inverters have an auto shut-off feature to protect them from damage when the voltage drops too low. The manual that came with your inverter will have this information, as well as a full troubleshooting guide.

3. My charge controller is in night mode

Check all the breakers and the wiring going into the breakers for any loose connections. You want to make sure the wires are tight, the metal wire is fully in contact with the breaker, and the insulation is not preventing a solid connection. Then, check your solar panels wiring, ensuring all connections are secure and the wires aren't damaged.

Once you ensure all connections are secure, reboot your charge controller by switching the breakers off and back on, as sometimes the charge controller will auto-detect the wrong voltage setting during the first boot-up.

4. My batteries aren't charging.

It's likely your batteries have been drawn very low, and are not able to charge fully if you continue to draw power. Check all the wiring is secure and undamaged, then turn off the breaker between the batteries and the inverter, leaving the others on, and let the batteries charge back up to full.

If you don't believe you have knowingly used enough power to drain the batteries, check all your appliances to see if something is using more power than it should.

5. My batteries drain very fast when the sun goes down

The controller may read 100% while charging at the higher voltage, but then it will quickly drop down lower when there is no charge applied. This could be because the batteries charge at a higher voltage, so when the sun goes down the battery voltage will stabilize at a lower level.

It may also mean the batteries have been drained low, and they are not getting enough charge to be fully charged by the end of the day.

Try reducing your power usage for a few days to make sure the batteries are getting fully charged, but also make sure to check the solar panels are not being shaded during the day, or there is an appliance that has been left on. When customers notice less solar output the most common cause is shading - as we transition between winter and summer the sun's path changes, which can cast new shadows across the panels which weren't noticed when you first installed the system.

6. My inverter beeped, and an orange light was blinking

You may hear your charge controller beep, and see an orange light blinking if you check quickly. This occurs when the battery voltage is too high. This can happen very occasionally when the charge controller is charging the batteries completely.

It can happen when you have a very sunny day, and use a high draw appliance like a toaster - when the toaster stops the solar then works very quickly to top off the batteries, and can peak the voltage briefly. As it's a smart inverter, it is working to protect itself and your batteries, so it can sometimes be a little bit on the over protective side.

7. My inverter fan turns on all the time

You may notice the fan turning on even when you're not using a high load appliance. The inverter can sometimes be a little overprotective of itself, especially on warm days, and the fan will turn on when it doesn't seem necessary. Make sure there is sufficient airflow around your inverter and you should be fine.

CONTACT US

Our website: gridfree.store

Email us: info@gridfree.store

Message us on Facebook: [@GridFree.Store](https://www.facebook.com/GridFree.Store)

Give us a call: (09) 218 5533

Address: By Appointment– C4/27 Smales Road, East Tāmaki, Auckland, 2013

Hours: 9am-5pm, Monday-Friday

Kit viewings, demos, and pick ups at Auckland warehouse by appointment only.
Please give us a call and we'll be happy to set up a time to meet you.

NOTES



GRIDFREE