

ET35

Tracked Conventional Tail Excavators



**WACKER
NEUSON**
all it takes!



Convincing productivity

The 3.5-ton class tracked excavator convinces with many sophisticated details. Features such as good stability or the new, ergonomically designed cabin ensure efficient and fatigue-free working. Due to the numerous factory-installed options, the ET35 can also be individually adapted to the customers needs.

- Performance meets maximum efficiency
- Intuitive operating concept and comfort cabin
- VDS - Working in the slope - without coming to falter
- Unrestricted maintenance and service access
- Compact dimensions meet intelligent design

ET35 Technical specifications

	ET35 - level III / Tier IVi	ET35 - Tier IV final
Operating data		
Shipping weight min. kg	3,260	3,260
Operating weight kg	3,450 - 4,361	3,450 - 4,361
Biting force max. kN	21.1	21.1
Breakout force max. kN	35	35
Digging depth max. (long dipper stick) mm	3,497	3,497
Dumping height mm	3,337 - 3,489	3,337 - 3,489
Digging radius max. (long dipper stick) mm	5,507	5,507
Superstructure slewing speed 1/min	9.5	9.5
L x W x H mm	5,268 x 1,630 x 2,491	5,268 x 1,630 x 2,491
Engine / Motor		
Engine / Motor manufacturer	Yanmar Diesel engine	Yanmar Diesel engine
Engine / Motor type	3TNV88-BPWN	3TNV88F-EPWN
Engine / Motor	Water-cooled 3-cylinder suction engine	Water-cooled 3-cylinder suction engine
Displacement cm ³	1,642	1,642
RPM / speed rpm	2,500	2,430
Engine performance POWER mode kW	22.2	18.2
Engine performance ECO mode kW		17.8
Battery Ah	71	71
Fuel tank capacity l	44	44
Voltage V	12	12
Input current A	71	71
Hydraulic system suppressing control		
Duty pump	2 axial piston pumps / 2 gear pumps	2 axial piston pumps / 2 gear pumps
Max. flow rate l/min	42.5 + 42.5	42.5 + 42.5
Max. flow rate l/min	23.8 + 11.3	23.8 + 11.3
Operating pressure for working and traction hydraulics bar	240	240
Operating pressure slewing gear bar	195	195
RPM / speed superstructure rpm	9.5	9.5
Undercarriage		
Travel speed max. km/h	4.7	4.7
Chain width mm	300	300
Ground clearance mm	251	251
Dozer Blade		
Width mm	1,630	1,630
Height mm	357	357
Stroke dozer blade above ground mm	392	392

ET35 - level III / Tier IVi

ET35 - Tier IV final

Stroke dozer blade below ground mm

505

505

ET35 Dimensions

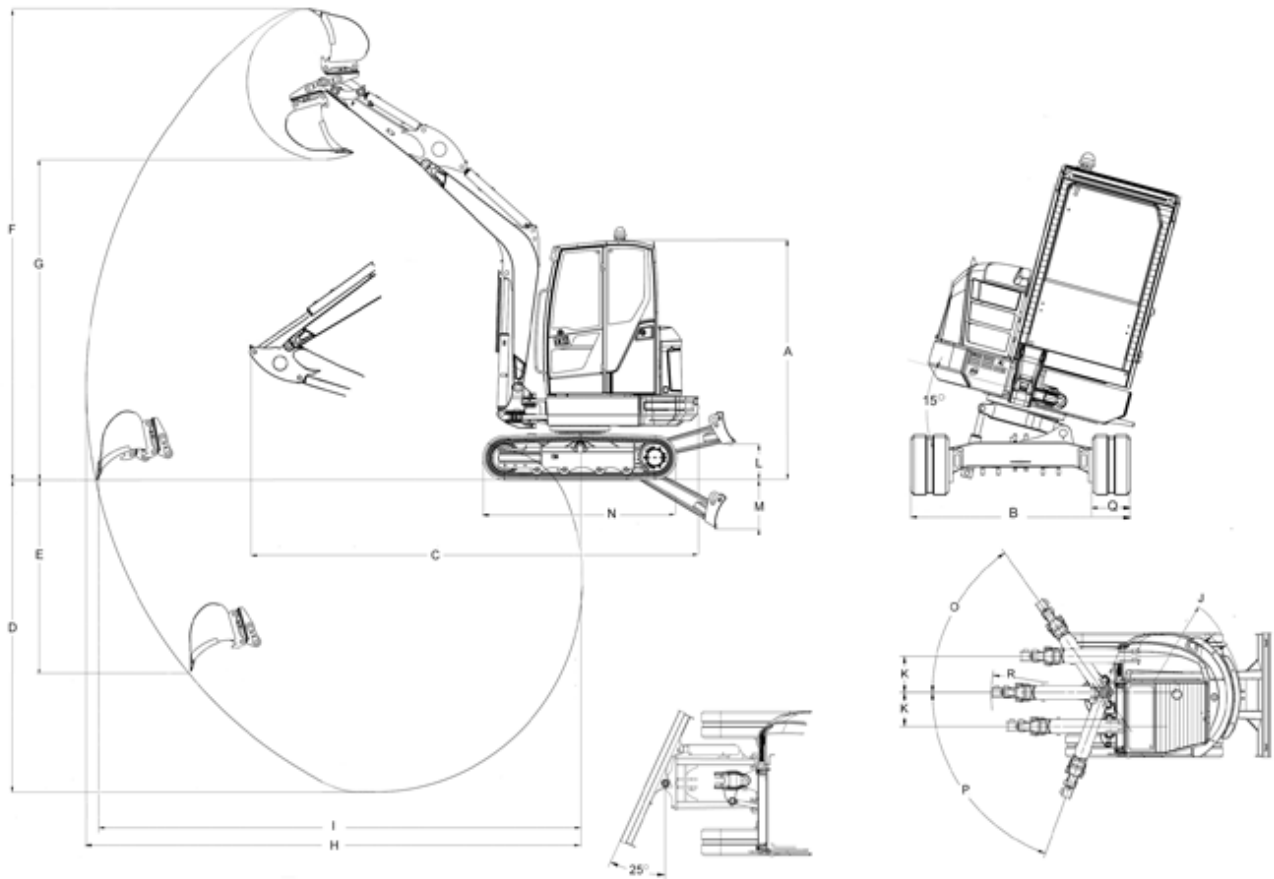

		with option VDS	
A	Height	2,491 mm	2,573 mm
B	Width	1,630 mm	1,630 mm
Q	Width undercarriage	300 mm	300 mm
C	Transport length (short DS)	5,268 mm	5,252 mm
D	Digging depth max. (short DS)	3,245 mm	3,166 mm
D	Digging depth max. (long DS)	3,497 mm	3,416 mm
E	Insertion depth max. vertical (short DS)	2,120 mm	2,042 mm
E	Insertion depth max. vertical (long DS)	2,360 mm	2,279 mm
F	Insertion height max. (short DS)	4,929 mm	5,010 mm
F	Insertion height max. (long DS)	5,082 mm	5,163 mm
G	Dump height max. (short DS)	3,337 mm	3,417 mm
G	Dump height max. (long DS)	3,489 mm	3,570 mm
H	Digging radius max. (short DS)	5,270 mm	5,270 mm
H	Digging radius max. (long DS)	5,507 mm	5,507 mm
I	Range on the ground max. (short DS)	5,158 mm	5,143 mm
I	Range on the ground max. (long DS)	5,408 mm	5,393 mm
J	Rear swivel radius	1,168 mm	1,168 mm
K	Arm displacement max. to center bucket right	476 mm	476 mm

K	Arm displacement max. to center bucket right	447 mm	447 mm
L	Lift height max. dozer blade above ground	393 mm	393 mm
M	Scraping depth max. dozer blade below ground	505 mm	505 mm
N	Length undercarriage	2,062 mm	2,062 mm
O	Turning angle max. boom to the right	55 °	55 °
P	Turning angle boom to the left	70 °	70 °

DS = dipper stick

Please note: that product availability can vary from country to country. It is possible that information / products may not be available in your country. More detailed information on engine power can be found in the operator's manual; the stated power may vary due to specific operating conditions. Subject to alterations and errors excepted. Applicable also to illustrations.
Copyright © 2019 Wacker Neuson SE.