

## Type SA-Jumbo (flange connection)

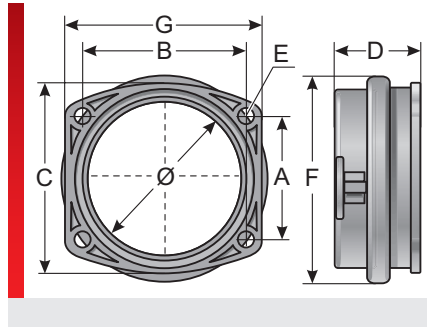

M-jumbo conduit connection







### PRODUCT INFORMATION





The SA-Jumbo flange connections are made of specially modified polyamide. The material is halogen, phosphor and cadmium-free. The SA-Jumbo flange connections feature the following advantages:

- Split ring makes assembly easy
- Tightness of IP 52 without DS seal
- Tightness of IP 65 with DS seal (DS seal must be ordered separately if required)

- Dimensionally stable connection ring ensures high tear-out strength
- Safety clips ensure protection against connection ring opening by itself
- O-ring for fastening flange included in delivery

### SPECIFICATIONS

-  UL listed material mod. polyamide PA 6
-  -40 – 110 °C short term 140 °C
-  IP52  
IP65 with sealing ring DS
-  acc. to UL94: V0 self-extinguishing
-  C.I.T. R22 / R23 HL3 : 0,58  
Ds (max.) R22 / R23 HL3 : 57  
LOI R22 / R23 HL3 : ≥ 32 %  
ASTM E 162
-  Boeing BSS 7239  
Boeing BSS 7242  
Bombardier SMP 800-C  
Alcohol
-  Greases  
Fuels  
Mineral oils

 HF
 RoHS
 UL US
 Made in Germany

Article	Order No.	Color	UV	A mm	B mm	C mm	D mm	E mm	F mm	G mm	Ø mm	PU pcs.
SA 56	83681020	Black	✓	60.00	66.00	85.00	50.00	6.50	94.00	86.00	60.00	1
SA 70	83681014	Black	✓	60.00	80.00	94.00	52.00	7.50	106.00	96.00	70.00	1
SA-80	83681015	Black	✓	74.00	108.00	126.00	52.00	7.50	132.00	126.00	95.00	1
SA 95	83681016	Black	✓	74.00	108.00	126.00	52.00	7.50	132.00	126.00	95.00	1
SA 56	83681008	Gray		60.00	66.00	85.00	50.00	6.50	94.00	86.00	60.00	1
SA 70	83681010	Gray		60.00	80.00	94.00	52.00	7.50	106.00	96.00	70.00	1
SA-80	83681011	Gray		74.00	108.00	126.00	52.00	7.50	132.00	126.00	95.00	1
SA 95	83681012	Gray		74.00	108.00	126.00	52.00	7.50	132.00	126.00	95.00	1

NFPA 130 applies only to the items in the product color black

### MATERIAL PROPERTIES



**Material**

UL listed material mod. polyamide PA 6

## Type SA-Jumbo (flange connection)

### THERMAL PROPERTIES



**Temperature / temperature range**  
-40 – 110 °C short term 140 °C

### PROTECTION CLASS



**Protection class**  
IP52  
IP65 with sealing ring DS

### FIRE PROPERTIES



**Fire classification**  
acc. to UL94: V0 self-extinguishing



**Fire properties as per EN 45545-2**  
C.I.T. R22 / R23 HL3 : 0,58  
Ds (max.) R22 / R23 HL3 : 57  
LOI R22 / R23 HL3 : ≥ 32 %



**Fire properties as per NFPA**  
ASTM E 162  
Boeing BSS 7239  
Boeing BSS 7242  
Bombardier SMP 800-C

### CHEMICAL RESISTANCE



**Resistant to:**  
Alcohol  
Greases  
Fuels  
Mineral oils

### TECHNICAL INFORMATION



**Halogen-free**

### CONFORMITY



**RoHS (EC Directive 2011/65/EU)**

### APPROVALS AND OPERATING PERMITS



**cURus approval**

### GENERAL INFORMATION



**Made in Germany**

## Type SA-Jumbo (flange connection)

All details given in our sales brochures and catalogues, as well as the information available online, are based on our current knowledge of the products described.

The electronic data and files made available by Murrplastik, particularly CAD files are based on our current knowledge of the product described.

A legally binding assurance of certain properties or the suitability for a certain purpose can not be determined from this information.

All information with respect to the chemical and physical properties of Murrplastik products, as well as application advice given verbally, in writing or by tests, is given to the best of our knowledge.

They do not release the buyer from the obligation to carry out his own tests and trials in order to determine the concrete suitability of the products for the intended purpose.

Murrplastik accepts no responsibility for the available information being up-to-date, correct or complete. Neither do we accept responsibility for the quality of this information.

Murrplastik accepts no liability for damage caused as a result of using our products.

Murrplastik reserves the right to make technical changes and improvements through constant further development of products and services.

Our General Terms and Conditions apply.

© Murrplastik Systemtechnik GmbH • proID\_65613~20230214~890283~suv\_sa\_jumbo