

Signal towers Ø45mm/1.77"

- Supplied already assembled
- Steady light and pulsed or continuous sound modules

Multicoloured signal towers
Ø70mm/2.75"

- Modular and combinations up to 5 modules
- Steady light and pulsed or continuous sound modules

Signal towers Ø70mm/2.75"

- Modular and combinations up to 7 modules
- Steady or blinking light, pulsed or continuous sound modules

Signal beacons Ø62mm/2.44"

- Steady or blinking light, pulsed or continuous sound modules.

Signal towers and beacons

	SEC. - PAGE
Signal towers Ø45mm/1.77"	8 - 2
Multicoloured signal towers Ø70mm/2.75"	8 - 3
Signal towers Ø70mm/2.75"	8 - 4
Signal beacons Ø62mm/2.44"	8 - 6
Accessories and spare parts	8 - 7

Dimensions	8 - 10
-------------------------	---------------

Wiring diagrams	8 - 13
------------------------------	---------------



Page 8-2

SIGNAL TOWERS Ø45mm/1.77"

- Signal towers supplied already assembled Ø45mm/1.77"
- Steady light modules
- Pulsed or continuous sound modules
- Built-in LED circuit.



Page 8-3

MULTICOLOURED SIGNAL TOWERS Ø70mm/2.75"

- Modular signal towers Ø70mm/2.75"
- Steady light multicoloured modules
- Pulsed or continuous sound multicoloured modules
- Built-in LED circuit.



Page 8-4 and 5

SIGNAL TOWERS Ø45mm/1.77"

- Signal towers supplied already assembled Ø45mm/1.77"
- Steady light modules
- Pulsed or continuous sound modules
- Incandescent and LED bulbs.



Page 8-6

MULTICOLOURED SIGNAL TOWERS Ø70mm/2.75"

- Modular signal towers Ø70mm/2.75"
- Steady light multicoloured modules
- Pulsed or continuous sound multicoloured modules
- Incandescent and LED bulbs.

Signal towers Ø45mm/1.77"



8 LT4 K02BG



8 LT4 K05BG



8 LT4 K09BG

new

Order code	Description	Qty per pkg	Wt [kg]
		n°	[kg]
Steady light and pulsed or continuous sound light modules. Built-in LED circuit ①.			
8 LT4 K02BG	Green, red, 24VDC	1	0.160
8 LT4 K03BG	Green, red with continuous or pulsed sound, 24VDC	1	0.240
8 LT4 K04BG	Green, orange, red, 24VDC	1	0.240
8 LT4 K05BG	Green, orange, red with continuous or pulsed sound, 24VDC	1	0.320
8 LT4 K06BG	Green, blue, orange, red, 24VDC	1	0.320
8 LT4 K07BG	Green, blue, orange, red, with continuous or pulsed sound, 24VDC	1	0.400
8 LT4 K08BG	White, green, blue, orange, red, 24VDC	1	0.400
8 LT4 K09BG	White, green, blue, orange, red, with continuous or pulsed sound, 24VDC	1	0.480

① For accessories and spare parts see page 8-7 and 8.

General characteristics

The Ø45mm/1.77" signal towers are supplied completely assembled with the possibility of up to 3 light modules with a sound module. The high-brightness LED circuit lighting ensures low consumption and long life.

Technical characteristics

- Supply voltage: 24VDC (±10%)
- Light module consumption: 37mA per module
- Sound module consumption: 15mA
- Sound intensity: 80dB/1m, pulsed or continuous sound
- Material: polycarbonate
- Connections: screw clamp terminals and maximum conductor section 1.5mm²/16 AWG
- Tightening torque: 0.5Nm/4.5lbin
- Operating temperature: -20...+50°C
- IEC degree of protection: IP54.

Certifications and compliance

Certifications obtained: cULus (pending), EAC. Compliant with standards: IEC/EN 60947-5-1, IEC/EN 60947-1, UL508, CSA C22.2 n° 14.

Combinations

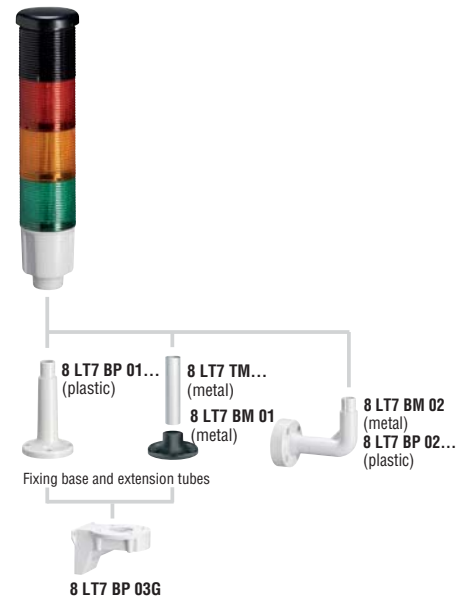

For accessories and spare parts see page 8-7 and 8.

Visual code	Red	Yellow	Orange	Blue	Green	White
Meaning	Danger. Emergency.	Warning and Caution. Abnormal situation.		Mandatory command.	Normal situation. Regular operation.	No specific meaning.
Sound	Fast modulated repetition or high-pitch pulsing.	Continuous short sound.		Alternating sound at constant tone	Constant and prolonged sound after an alarm.	Other sounds.
Correlated actions	Immediate intervention to deal with dangerous situation.	Control intervention required.		Intervention needed for mandatory action.	No specific action.	Depending on the situation.

Interpretation of light and sound signals for signal towers and beacons

Light and sound signals are a fundamental element for the safety of a system.

To avoid incorrect interpretations, a European standard has been introduced attributing an unambiguous meaning to visual or audible signals.

Each colour or sound alarm corresponds to a specific state of operation of the connected system and various levels of warning, as shown in the table above, according to EN 981-IEC/EN 60073 standards. The white module can be assigned a meaning as desired.

Multicoloured signal towers Ø70mm/2.75"



8 LT7 3S ...



8 LT7 3B ...

Order code	Description	Qty per pkg	Wt
		n°	[kg]
Steady light and pulsed or continuous sound multicoloured light modules. Built-in LED circuit ❶.			
8 LT7 3B 9A	Green, orange, red, 24VDC	1	0.090
8 LT7 3S2B 9A	Green, orange, red, with continuous or pulsed sound 24VDC	1	0.200
8 LT7 3B 9B	Blue, orange, red, 24VDC	1	0.090
8 LT7 3S2B 9B	Blue, orange, red, with continuous or pulsed sound 24VDC	1	0.200

❶ For accessories and spare parts see page 8-7 and 8.

General characteristics

The multicoloured signal towers incorporate the possibility of up to 3 different colours in a single light module. In the event of two or more alarms, the multicoloured module lights up in alternating colours corresponding to the event. The multicoloured module must always be placed last, at the top of the tower, should it be used together with light modules 8LT7 EL... 8LT7 GL ... or 8LT7 FL....

Technical characteristics

- Supply voltage: 24VDC (±10%)
- Light and sound module consumption: 90mA
- Sound intensity: 90dB/1m
- Material: polycarbonate
- Number of stackable elements: 4 with 8 LT7 3P modules, 1 with 8 LT7 3S modules
- Connections: screw clamp terminals and maximum conductor section 1.5mm²/16 AWG
- Tightening torque: 0.5Nm/4.5lbin
- Operating temperature: -20...+50 °C
- IEC degree of protection: IP65.

Certifications and compliance

Certifications obtained: cULus, EAC.
Compliant with standards: IEC/EN 60947-5-1, IEC/EN 60947-1, UL508, CSA C22.2 n° 14.

Combinations

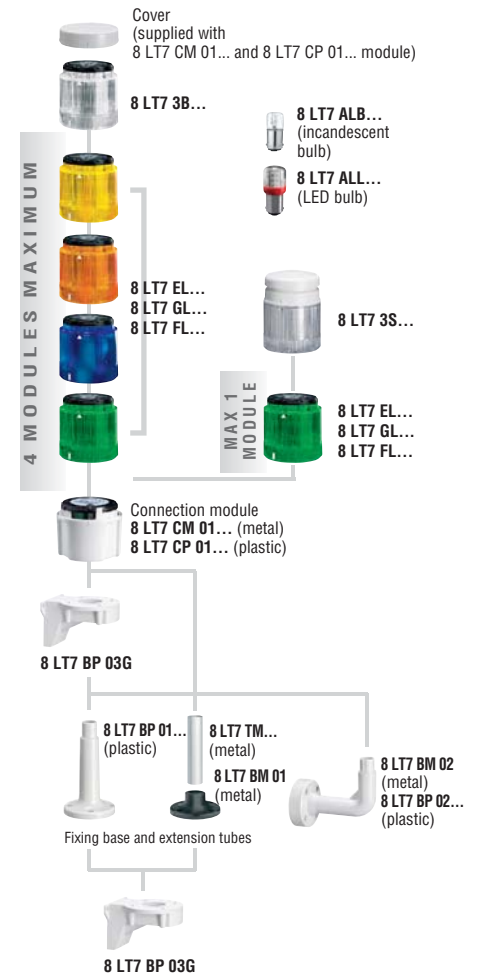

For accessories and spare parts see page 8-7 and 8.

Signal towers Ø70mm/2.75"



8 LT7 EL ...
8 LT7 GL ...
8 LT7 FL ...

Order code	Description	Qty per pkg	Wt
		n°	[kg]

Steady light modules. BA15d fitting ^①.
Bulb (8 LT7 ALB... and 8 LT7 ALL...) not included.

8 LT7 EL1	Orange	1	0.082
8 LT7 EL3	Green	1	0.082
8 LT7 EL4	Red	1	0.082
8 LT7 EL5	Yellow	1	0.082
8 LT7 EL6	Blue	1	0.082
8 LT7 EL8	White	1	0.082

Blinking light modules. BA15d fitting ^①.
Bulb (8 LT7 ALB... and 8 LT7 ALL...) not included.

8 LT7 GL B1	Orange, 24VAC/DC	1	0.083
8 LT7 GL B3	Green, 24VAC/DC	1	0.083
8 LT7 GL B4	Red, 24VAC/DC	1	0.083
8 LT7 GL B5	Yellow, 24VAC/DC	1	0.083
8 LT7 GL B6	Blue, 24VAC/DC	1	0.083
8 LT7 GL B8	White, 24VAC/DC	1	0.083
8 LT7 GL E1	Orange, 110...120VAC	1	0.083
8 LT7 GL E3	Green, 110...120VAC	1	0.083
8 LT7 GL E4	Red, 110...120VAC	1	0.083
8 LT7 GL E5	Yellow, 110...120VAC	1	0.083
8 LT7 GL E6	Blue, 110...120VAC	1	0.083
8 LT7 GL E8	White, 110...120VAC	1	0.083
8 LT7 GL M1	Orange, 230...240VAC	1	0.083
8 LT7 GL M3	Green, 230...240VAC	1	0.083
8 LT7 GL M4	Red, 230...240VAC	1	0.083
8 LT7 GL M5	Yellow, 230...240VAC	1	0.083
8 LT7 GL M6	Blue, 230...240VAC	1	0.083
8 LT7 GL M8	White, 230...240VAC	1	0.083

Flash light modules. With 4-joule xenon bulb ^①.

8 LT7 FL B1	Orange, 24VAC/DC	1	0.092
8 LT7 FL B3	Green, 24VAC/DC	1	0.092
8 LT7 FL B4	Red, 24VAC/DC	1	0.092
8 LT7 FL B5	Yellow, 24VAC/DC	1	0.092
8 LT7 FL B6	Blue, 24VAC/DC	1	0.092
8 LT7 FL B8	White, 24VAC/DC	1	0.092
8 LT7 FL E1	Orange, 110...120VAC	1	0.092
8 LT7 FL E3	Green, 110...120VAC	1	0.092
8 LT7 FL E4	Red, 110...120VAC	1	0.092
8 LT7 FL E5	Yellow, 110...120VAC	1	0.092
8 LT7 FL E6	Blue, 110...120VAC	1	0.092
8 LT7 FL E8	White, 110...120VAC	1	0.092
8 LT7 FL M1	Orange, 230...240VAC	1	0.092
8 LT7 FL M3	Green, 230...240VAC	1	0.092
8 LT7 FL M4	Red, 230...240VAC	1	0.092
8 LT7 FL M5	Yellow, 230...240VAC	1	0.092
8 LT7 FL M6	Blue, 230...240VAC	1	0.092
8 LT7 FL M8	White, 230...240VAC	1	0.092

^① For accessories and spare parts see page 8-7 and 8.

General characteristics

Signal towers are fundamental elements in manufacturing processes for the visual and audible signalling of the system status.

The signal towers can be assembled by stacking up to 7 modules, in the following sequence, starting from the top: red, yellow, orange, blue, green and white.

Technical characteristics

- Maximum operational voltage: 250VAC/DC
- Flash light and sound module consumption:
 - 8 LT7 FL B... in AC: 135mA
 - 8 LT7 FL B... in DC: 75mA
 - 8 LT7 FL E... 20mA
 - 8 LT7 FL M... 15mA
- Material: polycarbonate or anodised aluminium
- Number of stackable modules: 7
- Connections: screw clamp terminals and maximum conductor section 1.5mm²/16 AWG
- Tightening torque: 0.5Nm/4.5lbin
- Operating temperature: -20...+50°C (12VAC max. up to +40°C)
- IEC degree of protection: IP65.

Certifications and compliance

Certifications obtained: EAC, UL Listed, for USA and Canada (cULus - file E318016) as Power Circuit and motor-mounted Apparatus - Stackable tower lights.

Compliant with standards: IEC/EN 60947-5-1, IEC/EN 60947-1, UL508, CSA C22.2 n° 14.

Combinations

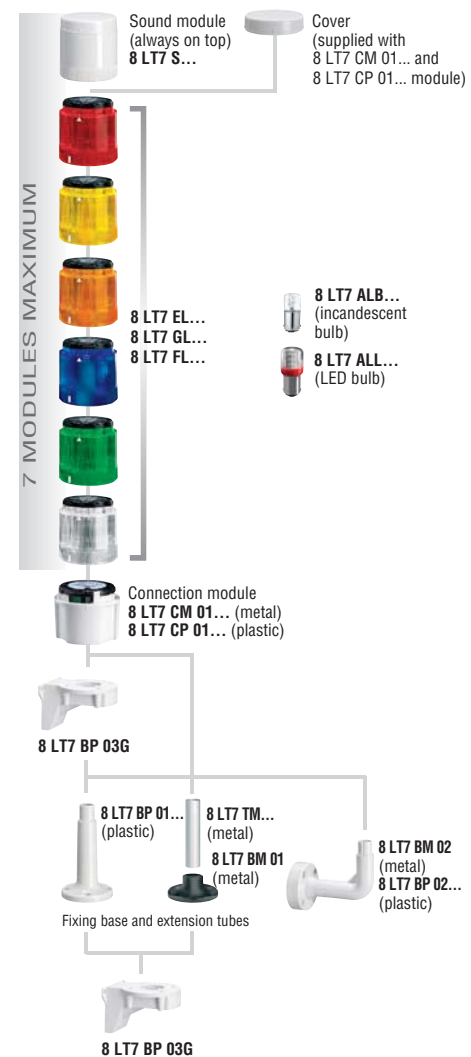

For accessories and spare parts see page 8-7 and 8.

Signal towers Ø70mm/2.75"



8 LT7 S ... G



8 LT7 S ...



8 LT7 CM 01 G
8 LT7 CP 01 G



8 LT7 CM 01
8 LT7 CP 01

Order code	Description	Qty per pkg	Wt	
		n°	[kg]	
Pulsed or continuous sound modules, grey colour ❶.				
8 LT7 S0 BG	24VAC/DC, pulsed (90dB). IP54	1	0.240	
8 LT7 S1 BG	24AC/DC, 16 sounds select. (max.80dB). IP65	1	0.240	
8 LT7 S2 BG	24VAC/DC	puls. sound (78dB)Ⓜ	1	0.240
8 LT7 S2 EG	110...120VAC	or continuous	1	0.240
8 LT7 S2 MG	230...240VAC	(75dB)Ⓜ. IP65	1	0.240
Pulsed or continuous sound modules, black colour ❶.				
8 LT7 S0 B	24VAC/DC, pulsed (90dB). IP54	1	0.240	
8 LT7 S1 B	24AC/DC, 16 sounds select. (max.80dB). IP65	1	0.240	
8 LT7 S2 B	24VAC/DC	puls. sound (78dB)Ⓜ	1	0.240
8 LT7 S2 E	110...120VAC	or continuous	1	0.240
8 LT7 S2 M	230...240VAC	(75dB)Ⓜ. IP65	1	0.240
Connection modules and cover (bottom entry).				
8 LT7 CP 01G	For plastic tubes, grey colour	1	0.110	
8 LT7 CM 01G	For metal tubes, grey colour	1	0.120	
8 LT7 CP 01	For plastic tubes, black colour	1	0.110	
8 LT7 CM 01	For metal tubes, black colour	1	0.120	

❶ For accessories and spare parts see page 8-7 and 8.

Ⓜ For 8 LT7 S2 B... = 84.5 dB.

Ⓜ For 8 LT7 S2 B... = 82.6 dB.

Technical characteristics

- The sound module must always be placed last, on the top of the tower (it cannot be fitted with an 8 LT7 3... multicoloured module).
- Sound module consumption:
 - 8 LT7 S0 B...: 25mA
 - 8 LT7 S1 B...: 40mA
 - 8 LT7 S2 B...: 200mA
 - 8 LT7 S2 E...: 40mA
 - 8 LT7 S2 M...: 30mA
- Material: polycarbonate
- Max. number of sound modules: 1 per tower
- Connections: screw clamp terminals and maximum conductor section 1.5mm²/16 AWG
- Tightening torque: 0.5Nm/4.5lbin
- Operating temperature: -20...+50°C (12VAC max. up to +40°C)
- IEC degree of protection: IP65 (IP54 if 8 LT7 S0 B... sound module used).

Certifications and compliance

Certifications obtained: EAC, UL Listed, for USA and Canada (cULus - file E318016) as Power Circuit and motor-mounted Apparatus - Stackable tower lights.

Compliant with standards: IEC/EN 60947-5-1, IEC/EN 60947-1, UL508, CSA C22.2 n° 14.

Combinations

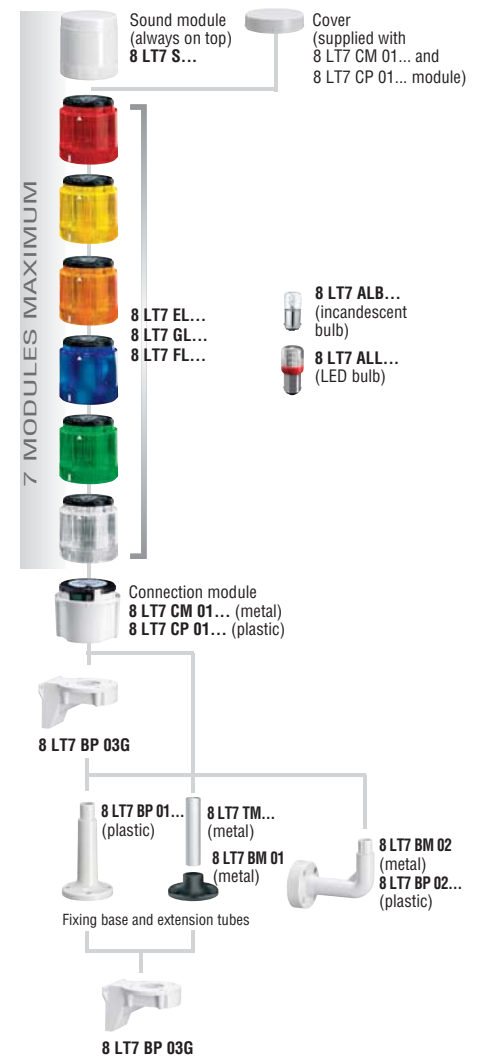

For accessories and spare parts see page 8-7 and 8.

Signal beacons Ø62mm/2.44"



8 LB6 EL...
8 LB6 GL...
8 LB6 S2...

Order code	Description	Qty per pkg	Wt
		n°	[kg]

Steady light modules. BA15d fitting.
Bulb (8 LT7 ALB... and 8 LT7 ALL...) not included.

8 LB6 EL1	Orange	1	0.060
8 LB6 EL3	Green	1	0.060
8 LB6 EL4	Red	1	0.060
8 LB6 EL5	Yellow	1	0.060
8 LB6 EL6	Blue	1	0.060
8 LB6 EL8	White	1	0.060

Blinking or steady light modules. BA15d fitting.
Bulb (8 LT7 ALB... and 8 LT7 ALL...) not included.

8 LB6 GL B1	Orange, 12...48VAC/DC	1	0.060
8 LB6 GL B3	Green, 12...48VAC/DC	1	0.060
8 LB6 GL B4	Red, 12...48VAC/DC	1	0.060
8 LB6 GL B5	Yellow, 12...48VAC/DC	1	0.060
8 LB6 GL B6	Blue, 12...48VAC/DC	1	0.060
8 LB6 GL B8	White, 12...48VAC/DC	1	0.060
8 LB6 GL M1	Orange, 24...230VAC	1	0.060
8 LB6 GL M3	Green, 24...230VAC	1	0.060
8 LB6 GL M4	Red, 24...230VAC	1	0.060
8 LB6 GL M5	Yellow, 24...230VAC	1	0.060
8 LB6 GL M6	Blue, 24...230VAC	1 <td 0.060	
8 LB6 GL M8	White, 24...230VAC	1	0.060

Light and sound pulsed or continuous sound modules.
Bulb included.

8 LB6 S2 B1	Orange, 24VAC/DC (80dB)	1	0.060
8 LB6 S2 B3	Green, 24VAC/DC (80dB)	1	0.060
8 LB6 S2 B4	Red, 24VAC/DC (80dB)	1	0.060
8 LB6 S2 B5	Yellow, 24VAC/DC (80dB)	1	0.060
8 LB6 S2 B6	Blue, 24VAC/DC (80dB)	1	0.060
8 LB6 S2 B8	White, 24VAC/DC (80dB)	1	0.060

General characteristics

Signal beacons are fundamental elements in manufacturing processes for the visual and audible signalling of the system status.

Technical characteristics

- Maximum operational voltage: 250VAC/DC
- Sound module consumption: 8 LB6 S2...:150mA
- Material: polycarbonate
- Connections: screw clamp terminals and maximum conductor section 1.5mm²/16 AWG
- Tightening torque: 0.5Nm/4.5lbin
- Operating temperature: -20...+50°C
- IEC degree of protection: IP54 (IP30 if used with bases 8 LB6 BP 04, 8 LB6 BP 06, 8 LB6 BP 08...).

Certifications and compliance

Certifications obtained: EAC.
Compliant with standards: IEC/EN 60947-5-1, IEC/EN 60947-1.

Combinations

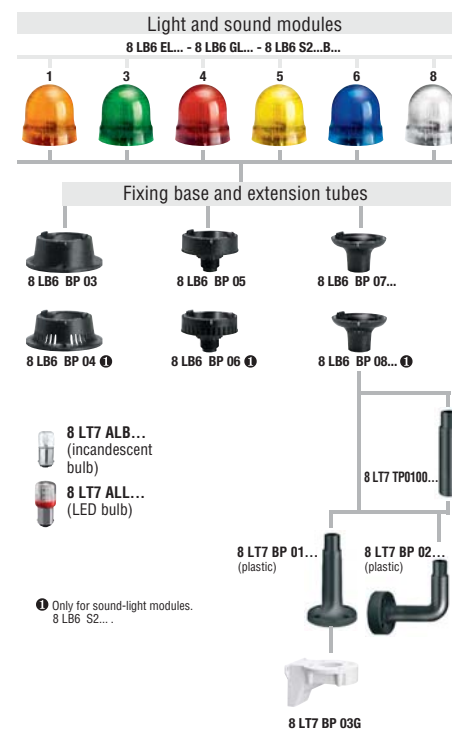

8 Signal towers and beacons

Accessories and spare parts

For signal towers and beacons



8 LT7 BP 01G



8 LT7 BP 01



8 LT7 BP 02G



8 LT7 BP 02



8 LT7 BP 03G



8 LT7 TP0100G



8 LT7 TP0100

Order code	Description	Qty per pkg	Wt [kg]
		n°	
Fixing bases.			
8 LT7 BP 01G	Horizontal surface mount, plastic grey colour with 100mm/3.94" extension	1	0.045
8 LT7 BP 02G	Vertical wall mount, plastic, grey colour	1	0.078
8 LT7 BP 03G	90° vertical wall mount, grey colour	1	0.080
8 LT7 BP 01	Horizontal surface mount, plastic, black colour with 100mm/3.94" extension	1	0.045
8 LT7 BP 02	Vertical wall mount, plastic, black colour	1	0.078
Extension tube for plastic bases.			
8 LT7 TP 0100G	100mm/3.94", grey colour	1	0.029
8 LT7 TP 0100	100mm/3.94", black colour	1	0.029

General characteristics

The assembly operation for the signal towers is simple and fast and does not require the use of any tools.

The bayonet fitting with slight pressure and simple circular movement makes it possible to mount each element on top of the previous one. There are specific white marks to indicate the correct alignment.

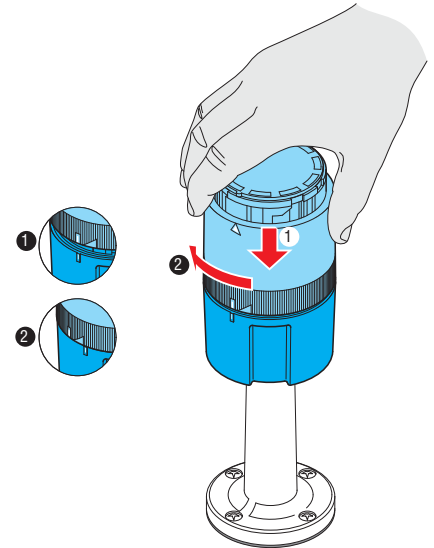

8 Signal towers and beacons

Accessories and spare parts

**For signal towers
Ø70mm/2.75"
and signal beacons
Ø62mm/2.44"**



8 LT7 ALB...



8 LT7 ALL...

Order code	Description	Qty per pkg	Wt
		n°	[kg]
Incandescent bulbs, 5W, BA15d fitting.			
8 LT7 ALB A	12VAC/DC	10	0.006
8 LT7 ALB B	24VAC/DC	10	0.006
8 LT7 ALB E	130VAC/DC	10	0.006
8 LT7 ALB M	260VAC/DC	10	0.006
LED bulbs, BA15d fitting.			
8 LT7 ALL A4	Red, 12VAC/DC	10	0.010
8 LT7 ALL A8	White, 12VAC/DC	10	0.010
8 LT7 ALL B3	Green, 24VAC/DC	10	0.010
8 LT7 ALL B4	Red, 24VAC/DC	10	0.010
8 LT7 ALL B5❶	Yellow/Orange, 24VAC/DC	10	0.010
8 LT7 ALL B6	Blue, 24VAC/DC	10	0.010
8 LT7 ALL B8	White, 24VAC/DC	10	0.010
8 LT7 ALL E3	Green, 110...120VAC	10	0.010
8 LT7 ALL E4	Red, 110...120VAC	10	0.010
8 LT7 ALL E5❶	Yellow/Orange, 110...120VAC	10	0.010
8 LT7 ALL E6	Blue, 110...120VAC	10	0.010
8 LT7 ALL E8	White, 110...120VAC	10	0.010
8 LT7 ALL M3	Green, 230...240VAC	10	0.010
8 LT7 ALL M4	Red, 230...240VAC	10	0.010
8 LT7 ALL M5❶	Yellow/Orange, 230...240VAC	10	0.010
8 LT7 ALL M6	Blue, 230...240VAC	10	0.010
8 LT7 ALL M8	White, 230...240VAC	10	0.010

❶ Used with yellow or orange light modules.

Technical characteristics

– Consumption of bulb fitted on light modules:

- 8 LT7 ALB A: 420mA
- 8 LT7 ALB B: 210mA
- 8 LT7 ALB E: 43mA
- 8 LT7 ALB M: 22mA
- 8 LT7 ALL A...: <60mA
- 8 LT7 ALL B...: <30mA
- 8 LT7 ALL E...: <20mA
- 8 LT7 ALL M...: <20mA.

Compliance

Compliant with standards: IEC/EN 60947-5-1, IEC/EN 60947-1, UL508, CSA C22.2 n° 14.

**Multicoloured signal towers
70mm/2.75" and signal towers
70mm/2.75"**



8 LT7 BM 01



8 LT7 BM 02



8 LT7 TM

Order code	Description	Qty per pkg	Wt
		n°	[kg]
Fixing bases.			
8 LT7 BM 01	Horizontal surface mount, metal, black	1	0.099
8 LT7 BM 02	Wall mount, metal	1	0.184
Extension tubes for metal bases, anodised aluminium.			
8 LT7 TM 0100	120mm/4.72"	1	0.016
8 LT7 TM 0200	220mm/8.66"	1	0.024
8 LT7 TM 0300	320mm/12.60"	1	0.048
8 LT7 TM 0400	420mm/16.53"	1	0.064
8 LT7 TM 0500	520mm/20.74"	1	0.080
8 LT7 TM 1000	1020mm/40.16"	1	0.160

For signal beacons Ø62mm/2.44"



8 LB6 BP07G



8 LB6 BP03



8 LB6 BP05



8 LB6 BP07



8 LB6 BP08G



8 LB6 BP04



8 LB6 BP06



8 LB6 BP08

Order code	Description	Qty per pkg	Wt
		n°	[kg]
Fixing bases for light modules.			
8 LB6 BP 07G	For extension connection, plastic, grey. Use with fixing bases 8 LP7 BP01G and 8 LP7 BP02G	1	0.020
8 LB6 BP 03	For horizontal mount, plastic, black	1	0.040
8 LB6 BP 05	For hole Ø22mm/0.87", plastic, black	1	0.040
8 LB6 BP 07	For extension connection, plastic, black. Use with fixing bases 8 LP7 BP01 and 8 LP7 BP02	1	0.020
Fixing bases for light and sound modules.			
8 LB6 BP 08G	For extension connection, plastic, grey. Use with fixing bases 8 LP7 BP01G and 8 LP7 BP02G	1	0.020
8 LB6 BP 04	For horizontal mount, plastic, black	1	0.040
8 LB6 BP 06	For hole Ø22mm/0.87", plastic, black	1	0.040
8 LB6 BP 08	For extension connection, plastic, black. Use with fixing bases 8 LP7 BP01 and 8 LP7 BP02	1	0.020

General characteristics

The assembly operation of the light and sound modules is simple and fast and does not require the use of any tools. There are specific white marks to indicate the correct alignment.

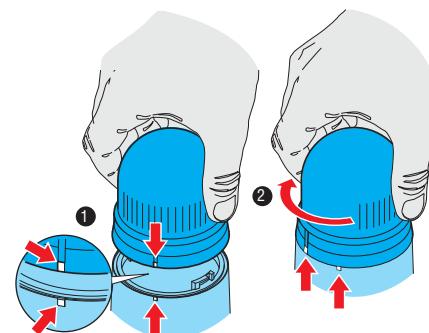

8 Signal towers and beacons

Dimensions [mm (in)]

SIGNAL TOWERS Ø45mm/1.77"

8 LT4 K02BG

8 LT4 K03BG

8 LT4 K04BG

8 LT4 K05BG

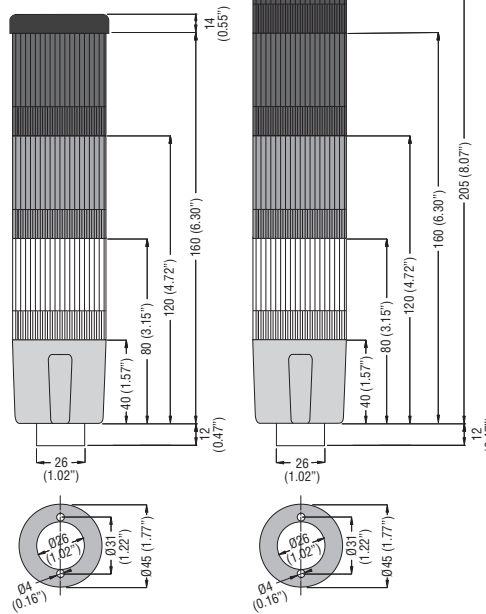
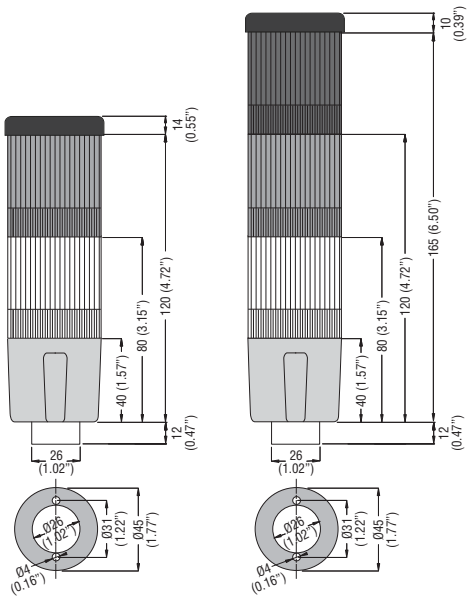

8 LT4 K06BG

8 LT4 K07BG

8 LT4 K08BG

8 LT4 K09BG

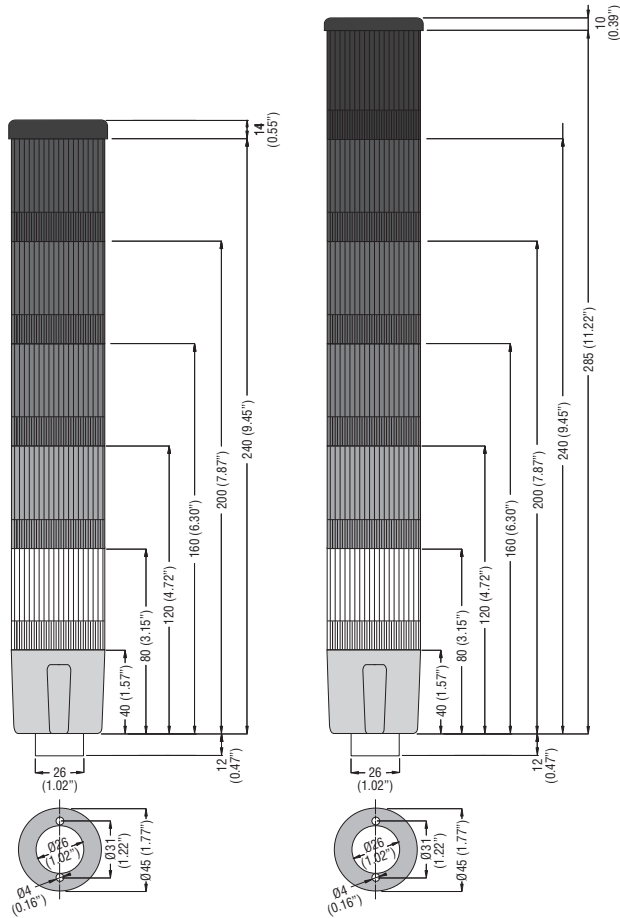
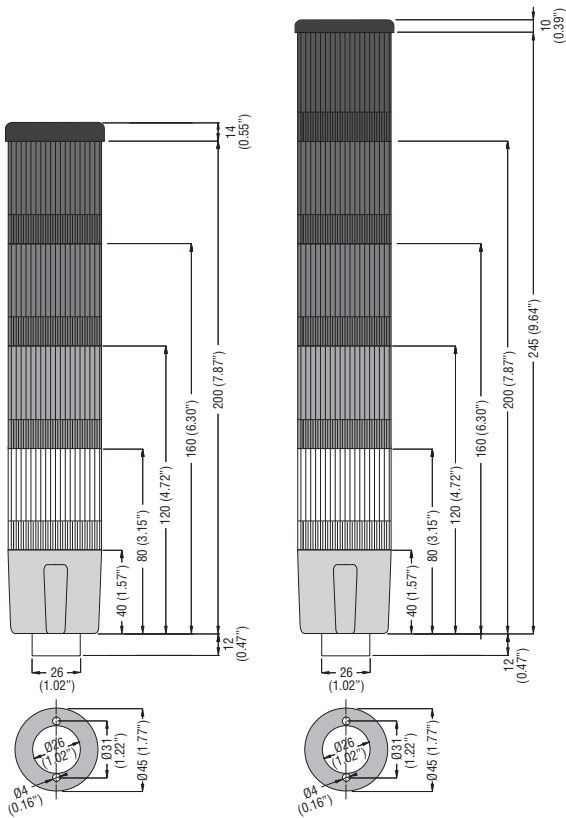

MULTICOLOURED SIGNAL TOWERS Ø70mm/2.75" AND SIGNAL TOWERS Ø70mm/2.75"

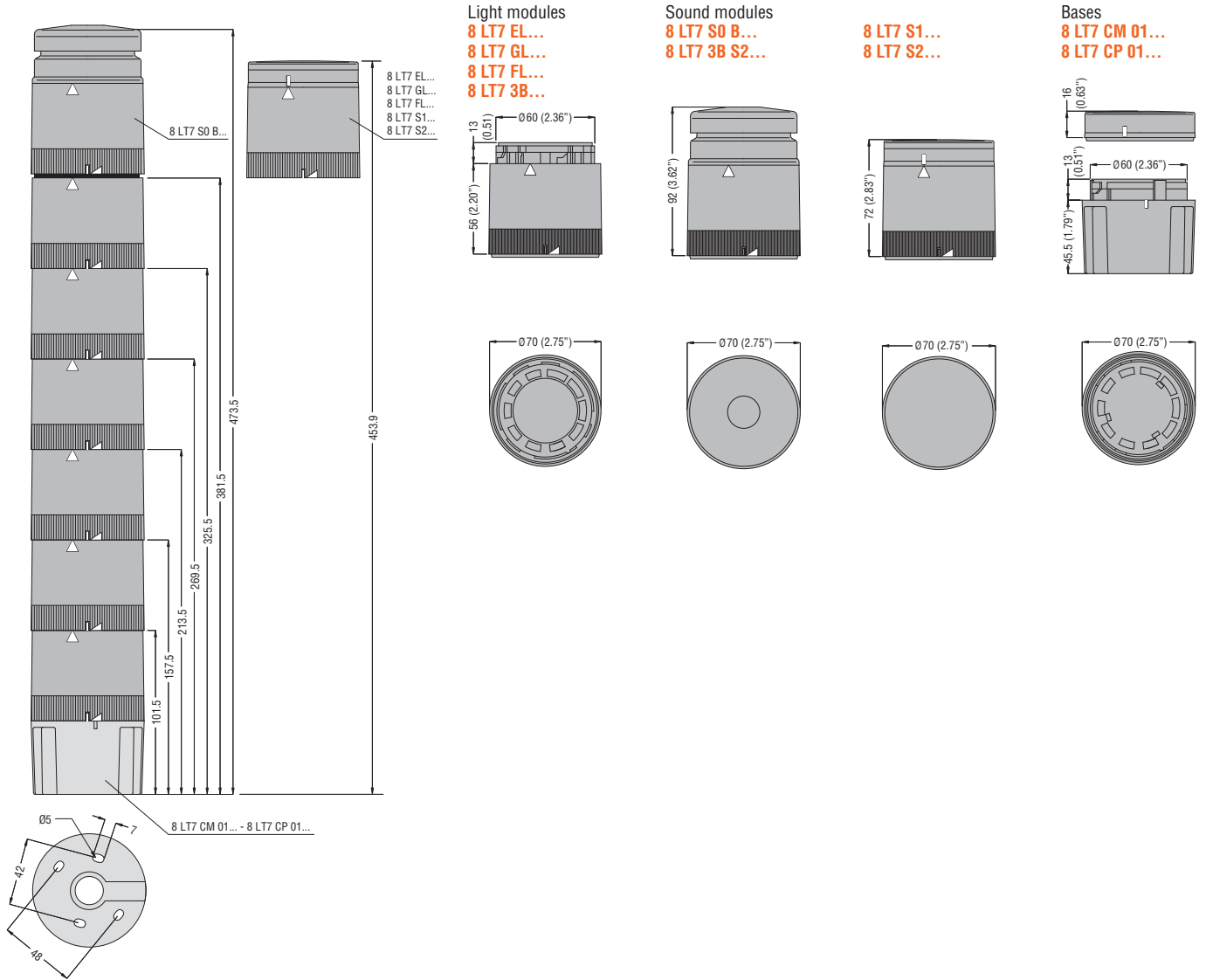

8 Signal towers and beacons

Dimensions [mm (in)]

SIGNAL BEACONS Ø62mm/2.44"

8 LB6 EL...
8 LB6 GL...
8 LB6 S2...

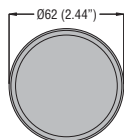
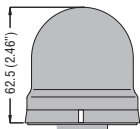

8 LB6...
with base 8 LB6 BP 03
and 8 LB6 BP 04 ❶

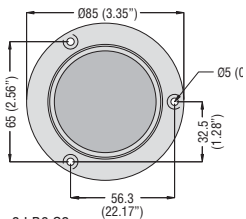
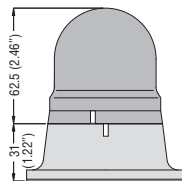

8 LB6...
with base 8 LB6 BP 05
and 8 LB6 BP 06 ❶

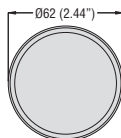
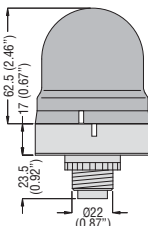

8 LB6...
with base 8 LB6 BP 07...
and 8 LB6 BP 08 ❶...

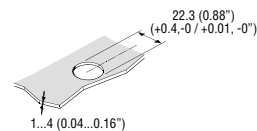
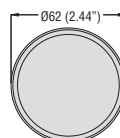
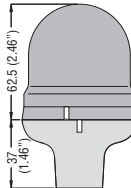

❶ With slits for light and sound modules 8 LB6 S2...

8 Signal towers and beacons

Dimensions [mm (in)]
Wiring diagrams

ACCESSORIES - Bases and extensions

8 LT7 BP 01...

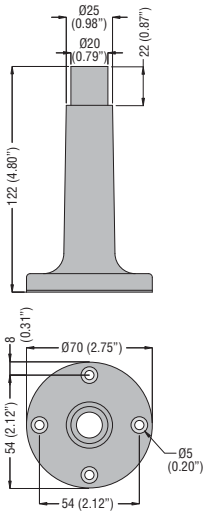

8 LT7 BP 02...

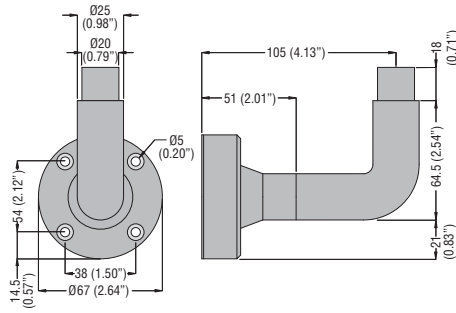

8 LT7 BM 01

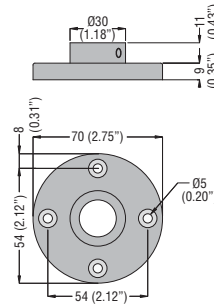

8 LT7 BM 02

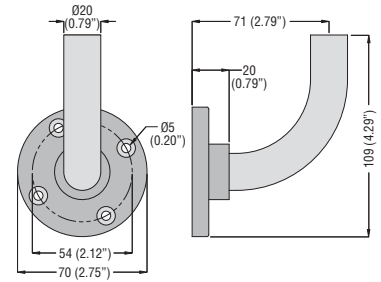

8 LT7 TP 0100...

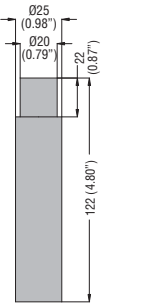

8 LT7 TM...

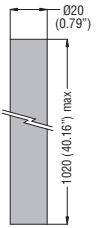

8 LT7 BP 03G

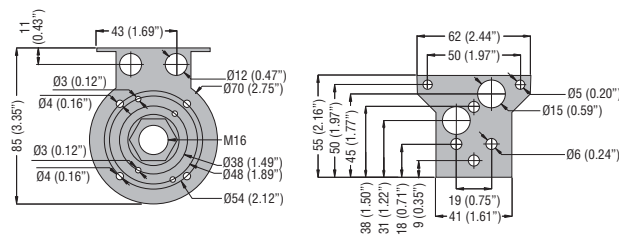

Wiring diagrams

ASSEMBLED SIGNAL TOWERS Ø45mm/1.77"

8 LT4...

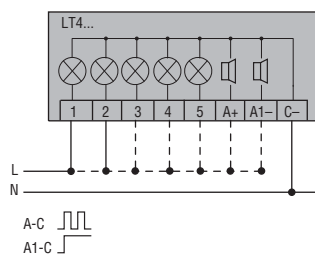

MULTICOLOURED SIGNAL TOWERS Ø70mm/2.75"
AND SIGNAL TOWERS Ø70mm/2.75"

8 LT7...

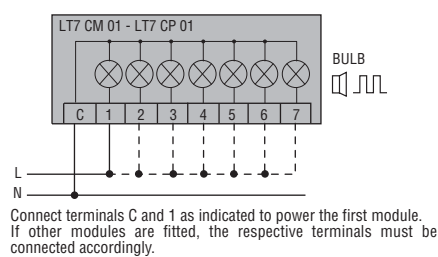

SIGNAL BEACONS Ø62mm/2.44"

8 LB6...

