



Figure can vary

Part no.: 50121909
SLS46C-40.K28-M12
Single beam safety device transmitter



Contents

- Technical data
- Dimensioned drawings
- Electrical connection
- Operation and display
- Accessories
- Notes



Part no.: 50121909 – SLS46C-40.K28-M12 – Single beam safety device

Technical data

Basic data	
Series	46C
Characteristic parameters	
Type	2, IEC/EN 61496
MTTF _d	400 years, EN ISO 13849-1
Mission time T _M	20 years, EN ISO 13849-1
Optical data	
Operating range	0.5 ... 40 m
Operating range limit	0.5 ... 48 m
Light source	LED, Red
LED light wavelength	630 nm
Transmitted-signal shape	Pulsed
LED protection class	1
Timing	
Switching frequency	250 Hz
Response time	2.5 ms
Readiness delay	300 ms
Electrical data	
Protective circuit	Polarity reversal protection, Short circuit protected
Performance data	
Supply voltage	24 V, DC, -20 ... 20 %, Incl. residual ripple
Residual ripple	10 %, From U _B
Open-circuit current	0 ... 40 mA
Inputs	
Number of activation inputs	1 Piece(s)
Activation inputs	
Voltage type	DC
Switching voltage	high: ≥8V, low: ≤1.5V
Switching voltage high, min.	8 V
Switching voltage low, max.	1.5 V
Activation/disable delay	1 ms
Input resistance	10.000 Ω, -30 ... 30 %
Activation input 1	
Assignment	Connection 1, pin 4
Active switching state	High
Connection	
Number of connections	1 Piece(s)

Part no.: 50121909 – SLS46C-40.K28-M12 – Single beam safety device

Connection 1

Type of connection	Connector
Function	Voltage supply, Signal IN
Thread size	M12
Material	Plastic
No. of pins	4 -pin

Mechanical data

Design	Cubic
Width	20.5 mm x 76.3 mm x 44 mm
Housing material	Plastic, PC-PBT
Lens cover material	Plastic (PMMA)
Net weight	50 g
Housing color	Red
Type of fastening	Through-hole mounting

Operation and display

Type of display	LED
Number of LEDs	2 Piece(s)

Environmental data

Ambient temperature, operation	-30 ... 60 °C
Ambient temperature, storage	-30 ... 70 °C
Environmental test	ECOLAB

Certifications

Degree of protection	IP 67, IP 69K
Protection class	III, Rating voltage 50 V
Certifications	c UL US, TÜV Süd
Standards applied	IEC 60947-5-2, IEC/EN 61496

Functions

Functions	Activation input
-----------	------------------

Classification

eCl@ss 8.0	27272701
eCl@ss 9.0	27272701
ETIM 5.0	EC001831

Dimensioned drawings

All dimensions in millimeters

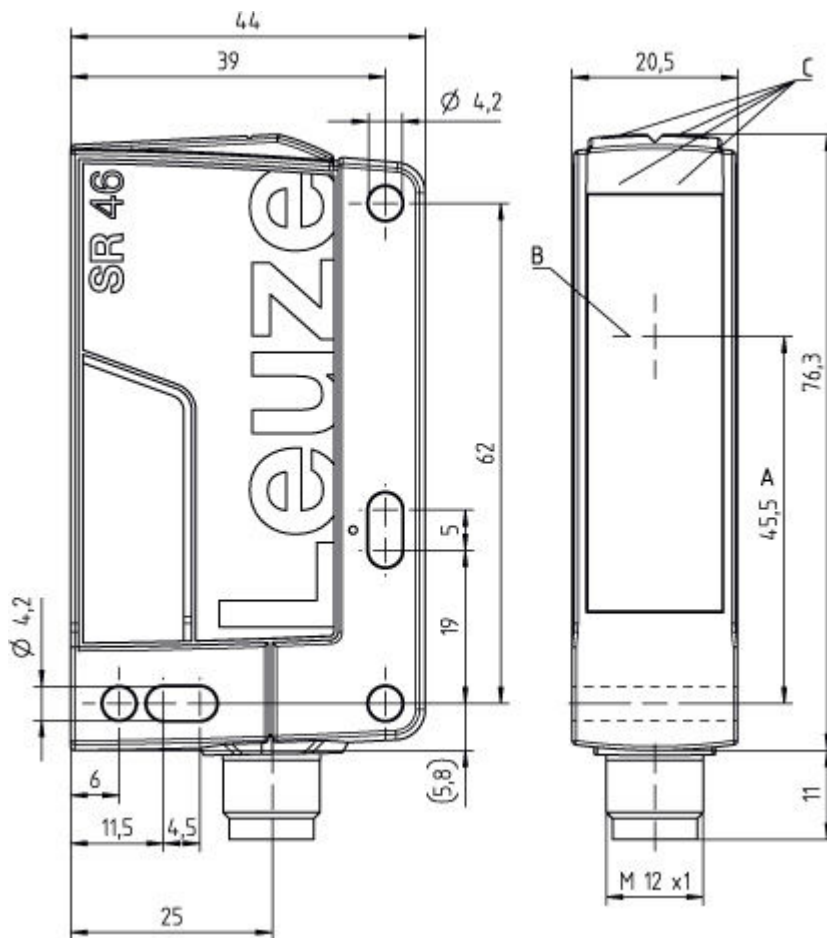

- A Optical axis
- B Transmitter and receiver
- C Green/yellow indicator diodes

Electrical connection

Connection 1	
Type of connection	Connector
Function	Voltage supply, Signal IN
Thread size	M12
Type	Male
Material	Plastic
No. of pins	4 -pin
Encoding	A-coded

Pin	Pin assignment	Conductor color
1	+24V	Brown
2	n.c.	White
3	GND	Blue
4	Active	Black

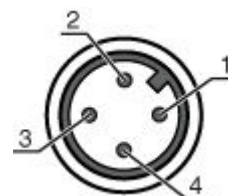







Operation and display

LEDs







LED	Display	Meaning
1	Green, continuous light	Ready
2	Yellow, continuous light	Transmitter activated

Accessories

Connection technology - Connection cables

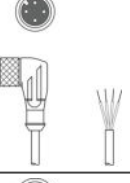
	Part no.	Designation	Article	Description
	50104565	K-D M12A-4P-10m-PUR	Connection cable	Connection 1: Connector, M12, Axial, Female, A-coded, 4 -pin Connection 2: Open end Shielded: No Cable length: 10,000 mm Sheathing material: PUR
	50104546	K-D M12A-4P-10m-PVC	Connection cable	Connection 1: Connector, M12, Axial, Female, A-coded, 4 -pin Connection 2: Open end Shielded: No Cable length: 10,000 mm Sheathing material: PVC
	50104753	K-D M12A-4P-20m-PVC	Connection cable	Connection 1: Connector, M12, Axial, Female, A-coded, 4 -pin Connection 2: Open end Shielded: No Cable length: 20,000 mm Sheathing material: PVC
	50104561	K-D M12A-4P-2m-PUR	Connection cable	Connection 1: Connector, M12, Axial, Female, A-coded, 4 -pin Connection 2: Open end Shielded: No Cable length: 2,000 mm Sheathing material: PUR
	50104542	K-D M12A-4P-2m-PVC	Connection cable	Connection 1: Connector, M12, Axial, Female, A-coded, 4 -pin Connection 2: Open end Shielded: No Cable length: 2,000 mm Sheathing material: PVC
	50123532	K-D M12A-4P-30m-PVC	Connection cable	Connection 1: Connector, M12, Axial, Female, A-coded, 4 -pin Connection 2: Open end Shielded: No Cable length: 30,000 mm Sheathing material: PVC
	50104563	K-D M12A-4P-5m-PUR	Connection cable	Connection 1: Connector, M12, Axial, Female, A-coded, 4 -pin Connection 2: Open end Shielded: No Cable length: 5,000 mm Sheathing material: PUR

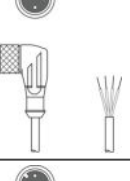
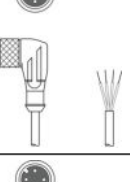
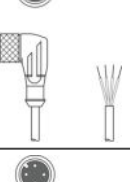
Part no.: 50121909 – SLS46C-40.K28-M12 – Single beam safety device

	Part no.	Designation	Article	Description
	50104544	K-D M12A-4P-5m-PVC	Connection cable	Connection 1: Connector, M12, Axial, Female, A-coded, 4 -pin Connection 2: Open end Shielded: No Cable length: 5,000 mm Sheathing material: PVC
	50104566	K-D M12W-4P-10m-PUR	Connection cable	Connection 1: Connector, M12, Angled, Female, A-coded, 4 -pin Connection 2: Open end Shielded: No Cable length: 10,000 mm Sheathing material: PUR
	50104547	K-D M12W-4P-10m-PVC	Connection cable	Connection 1: Connector, M12, Angled, Female, A-coded, 4 -pin Connection 2: Open end Shielded: No Cable length: 10,000 mm Sheathing material: PVC
	50113473	K-D M12W-4P-20M-PVC	Connection cable	Connection 1: Connector, M12, Angled, Female, A-coded, 4 -pin Connection 2: Open end Shielded: No Cable length: 20,000 mm Sheathing material: PVC
	50104562	K-D M12W-4P-2m-PUR	Connection cable	Connection 1: Connector, M12, Angled, Female, A-coded, 4 -pin Connection 2: Open end Shielded: No Cable length: 2,000 mm Sheathing material: PUR
	50104543	K-D M12W-4P-2m-PVC	Connection cable	Connection 1: Connector, M12, Angled, Female, A-coded, 4 -pin Connection 2: Open end Shielded: No Cable length: 2,000 mm Sheathing material: PVC
	50104564	K-D M12W-4P-5m-PUR	Connection cable	Connection 1: Connector, M12, Angled, Female, A-coded, 4 -pin Connection 2: Open end Shielded: No Cable length: 5,000 mm Sheathing material: PUR
	50104545	K-D M12W-4P-5m-PVC	Connection cable	Connection 1: Connector, M12, Angled, Female, A-coded, 4 -pin Connection 2: Open end Shielded: No Cable length: 5,000 mm Sheathing material: PVC

Mounting technology - Mounting brackets

	Part no.	Designation	Article	Description
	50105315	BT 46	Mounting device	Design of mounting device: Angle, L-shape Mounting bracket, at system: Through-hole mounting Mounting bracket, at device: Screw type Type of mounting device: Rigid Material: Metal

Part no.: 50121909 – SLS46C-40.K28-M12 – Single beam safety device

Mounting technology - Rod mounts

	Part no.	Designation	Article	Description
	50117253	BTU 300M-D10	Mounting system	Contains: 2x M4 x 25 screw, 2x M4 x 20 screw, 4x position washers Design of mounting device: Mounting system Mounting bracket, at system: For 10 mm rod, Sheet-metal mounting Mounting bracket, at device: Screw type Type of mounting device: Clampable, Adjustable, Turning, 360° Material: Metal
	50117252	BTU 300M-D12	Mounting system	Contains: 2x M4 x 25 screw, 2x M4 x 20 screw, 4x position washers Design of mounting device: Mounting system Mounting bracket, at system: For 12 mm rod, Sheet-metal mounting Mounting bracket, at device: Screw type Type of mounting device: Clampable, Adjustable, Turning, 360° Material: Metal
	50117251	BTU 300M-D14	Mounting system	Contains: 2x M4 x 25 screw, 2x M4 x 20 screw, 4x position washers Design of mounting device: Mounting system Mounting bracket, at system: For 14 mm rod, Sheet-metal mounting Mounting bracket, at device: Screw type Type of mounting device: Clampable, Adjustable, Turning, 360° Material: Metal
	50120425	BTU 300M.5-D12	Mounting system	Contains: 2x M4 x 25 screw, 2x M4 x 20 screw, 2x position washers, 2x M4 mounting nut Design of mounting device: Mounting system Mounting bracket, at system: For 12 mm rod, Sheet-metal mounting Mounting bracket, at device: Screw type Type of mounting device: Clampable, Adjustable, Turning, 360° Material: Stainless steel
	50122797	BTU 346M-D12	Mounting system	Contains: 2x M4 x 25 screw, 2x position washers Design of mounting device: Mounting system Mounting bracket, at system: For 12 mm rod, Sheet-metal mounting Mounting bracket, at device: Screw type Type of mounting device: Turning, 360°, Clampable, Adjustable Material: Metal
	50122798	BTU 346M.5-D12	Mounting system	Design of mounting device: Mounting system Mounting bracket, at system: For 12 mm rod, Sheet-metal mounting Mounting bracket, at device: Screw type Type of mounting device: Turning, 360°, Clampable, Adjustable Material: Stainless steel
	50119332	BTU 900M-D10	Mounting system	Contains: 2x M4 x 10 screw, 2x position washers Design of mounting device: Mounting system Mounting bracket, at system: For 10 mm rod, Sheet-metal mounting Mounting bracket, at device: Screw type Type of mounting device: Clampable, Turning, 360°, Swiveling Material: Metal
	50119331	BTU 900M-D12	Mounting system	Contains: 2x position washers, 2x M4 x 10 screw Design of mounting device: Mounting system Mounting bracket, at system: For 12 mm rod, Sheet-metal mounting Mounting bracket, at device: Screw type Type of mounting device: Clampable, Turning, 360°, Swiveling Material: Metal
	50119330	BTU 900M-D14	Mounting system	Contains: 2x position washers, 2x M4 x 10 screw Design of mounting device: Mounting system Mounting bracket, at system: For 14 mm rod, Sheet-metal mounting Mounting bracket, at device: Screw type Type of mounting device: Clampable, Turning, 360°, Swiveling Material: Metal

Part no.: 50121909 – SLS46C-40.K28-M12 – Single beam safety device

Alignment aids

	Part no.	Designation	Article	Description
	50109545	SAT 5	Alignment aid	Housing material: Metal

Notes

Observe intended use!

- The product may only be put into operation by competent persons.
- Only use the product in accordance with its intended use.

For UL applications:

- Certification: UL 508, C22.2 No.14-13
- Only for use in "class 2" circuits
- These proximity switches shall be used with UL Listed Cable assemblies rated 30V, 0.5A min, in the field installation, or equivalent (categories: CYJV/CYJV7 or PVVA/PVVA7)

- Typ. operating range limit: max. attainable range without function reserve
- Operating range: recommended range with function reserve
- Average life expectancy 100,000 h at an ambient temperature of 25 °C